

Automation Software

## Sysmac Studio

### Robot Integrated System Building Function with Robot Integrated CPU Unit Operation Manual

**SYSMAC-SE2□□□**  
**SYSMAC-SE200D-64**



## NOTE

1. All rights reserved. No part of this publication may be reproduced, stored in a retrieval system, or transmitted, in any form, or by any means, mechanical, electronic, photocopying, recording, or otherwise, without the prior written permission of OMRON.
2. No patent liability is assumed with respect to the use of the information contained herein. Moreover, because OMRON is constantly striving to improve its high-quality products, the information contained in this manual is subject to change without notice.
3. Every precaution has been taken in the preparation of this manual. Nevertheless, OMRON assumes no responsibility for errors or omissions. Neither is any liability assumed for damages resulting from the use of the information contained in this publication.

## Trademarks

- Sysmac and SYSMAC are trademarks or registered trademarks of OMRON Corporation in Japan and other countries for OMRON factory automation products.
- Microsoft, Windows, Excel, Visual Basic, and Microsoft Edge are either registered trademarks or trademarks of Microsoft Corporation in the United States and other countries.
- EtherCAT® is registered trademark and patented technology, licensed by Beckhoff Automation GmbH, Germany.
- ODVA, CIP, CompoNet, DeviceNet, and EtherNet/IP are trademarks of ODVA.
- The SD and SDHC logos are trademarks of SD-3C, LLC. 
- NVIDIA, the NVIDIA logo, GeForce, and the GeForce logo are the trademarks or registered trademarks of NVIDIA Corporation in the USA and other countries.
- ATI™ and Radeon™ are the trademarks of Advanced Micro Devices, Inc.
- Celeron, Intel and Intel Core are trademarks of Intel Corporation in the U.S. and / or other countries.
- Git and the Git logo are either registered trademarks or trademarks of Software Freedom Conservancy, Inc., corporate home of the Git Project, in the United States and/or other countries.
- JavaScript® is a trademark or registered trademark of Oracle Corporation and its subsidiaries and affiliates in the United States and other countries.
- EPLAN and EPLAN Electric P8 are registered trademarks of EPLAN GmbH & Co.KG.

Other company names and product names in this document are the trademarks or registered trademarks of their respective companies.

## Copyrights

Microsoft product screen shots used with permission from Microsoft.

# Introduction

---

Thank you for purchasing the Sysmac Studio Automation Software.

This manual contains information that is necessary to configure Robot Integrated System using Sysmac Studio Robot Integrated CPU Unit. Please read this manual and make sure you understand the functionality and performance of the Sysmac Studio before you attempt to use it in a control system. Keep this manual in a safe place where it will be available for reference during operation.

## Intended Audience

This manual is intended for the following personnel, who must also have knowledge of electrical systems (an electrical engineer or the equivalent).

- Personnel in charge of introducing FA systems.
- Personnel in charge of designing FA systems.
- Personnel in charge of installing and maintaining FA systems.
- Personnel in charge of managing FA systems and facilities.

Also, this manual is intended for the personnel, who understand the following contents.

- Personnel who understand the programming language specifications in international standard IEC 61131-3 or Japanese standard JIS B 3503, for programming.
- Personnel in charge of working with a robot and well knowing how to handle the robot.

## Applicable Products

This manual covers the following products.

- Sysmac Studio Standard Edition
- NJ501-R□□□ CPU Unit

Part of the specifications and restrictions for the products are given in other manuals.

Refer to *Related Manuals* on page 17.

# Manual Structure

## Page Structure

The following page structure is used in this manual.

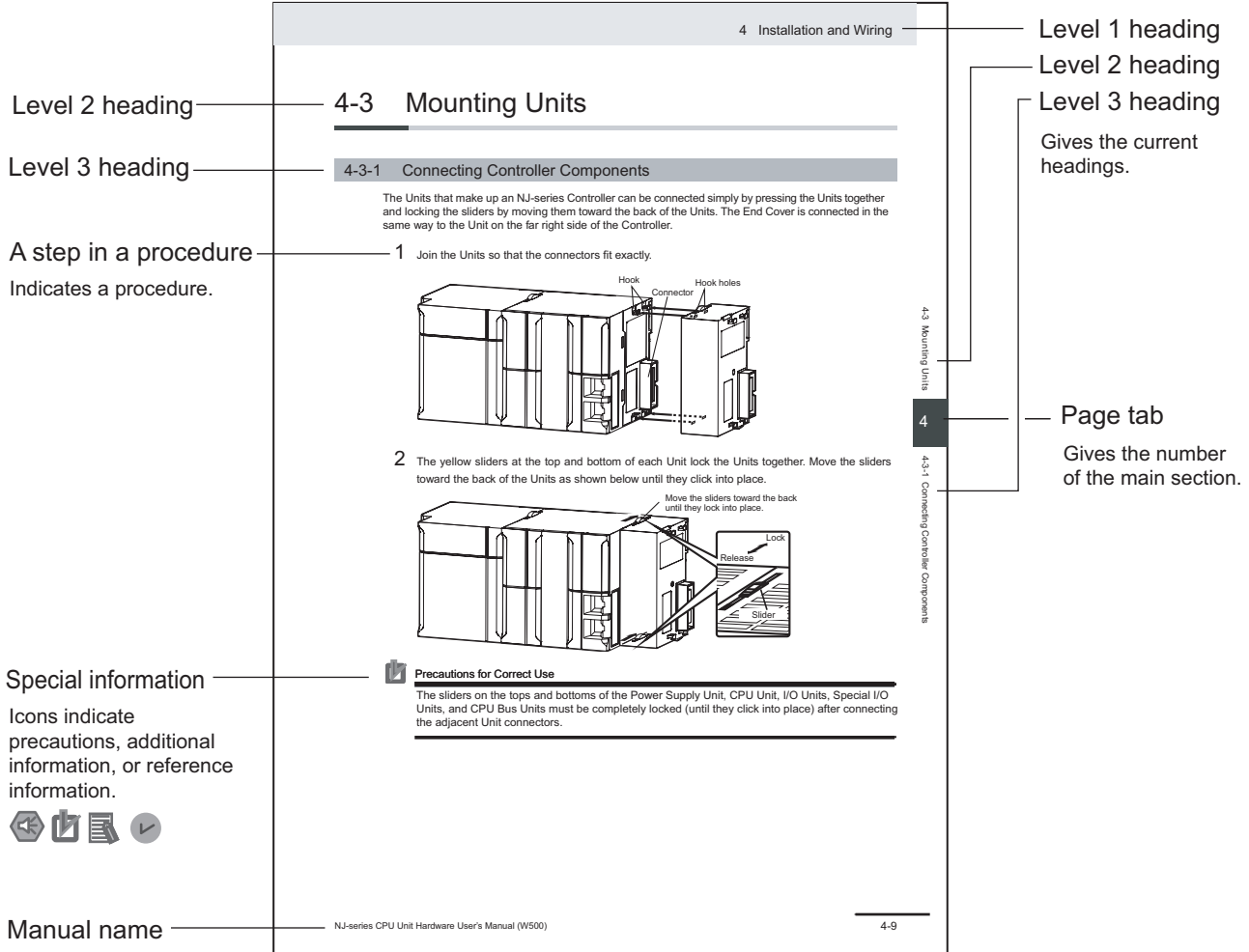

This illustration is provided only as a sample. It may not literally appear in this manual.

## Special Information

Special information in this manual is classified as follows:



### Precautions for Safe Use

Precautions on what to do and what not to do to ensure safe usage of the product.



### Precautions for Correct Use

Precautions on what to do and what not to do to ensure proper operation and performance.



### Additional Information

Additional information to read as required.

This information is provided to increase understanding or make operation easier.



### Version Information

Information on differences in specifications and functionality for Controllers and Units with different unit versions and for different versions of Support Software is given.

## Precaution on Terminology

In this manual, *download* refers to transferring data from the Sysmac Studio to the physical Controller and *upload* refers to transferring data from the physical Controller to the Sysmac Studio.

For the Sysmac Studio, *synchronization* is used to both *upload* and *download* data. Here, *synchronize* means to automatically compare the data for the Sysmac Studio on the computer with the data in the physical Controller and transfer the data in the direction that is specified by the user.



# Sections in this Manual

<b>1</b>	<b>Features and Specifications</b>	<b>10</b>	<b>Other Functions</b>	<b>1</b>	<b>10</b>
<b>2</b>	<b>Software Setup</b>	<b>A</b>	<b>Appendices</b>	<b>2</b>	<b>A</b>
<b>3</b>	<b>Building the Robot Integrated System</b>	<b>I</b>	<b>Index</b>	<b>3</b>	<b>I</b>
<b>4</b>	<b>System Design</b>			<b>4</b>	
<b>5</b>	<b>Configurations and Settings of the Controller</b>			<b>5</b>	
<b>6</b>	<b>Programming</b>			<b>6</b>	
<b>7</b>	<b>Debugging Robot Integrated System</b>			<b>7</b>	
<b>8</b>	<b>Connection and Transfer to Physical Controller</b>			<b>8</b>	
<b>9</b>	<b>Maintenance</b>			<b>9</b>	

# CONTENTS

---

<b>Introduction .....</b>	<b>1</b>
Intended Audience .....	1
Applicable Products .....	1
<b>Manual Structure.....</b>	<b>2</b>
Page Structure .....	2
Special Information .....	2
Precaution on Terminology .....	3
<b>Sections in this Manual .....</b>	<b>5</b>
<b>Terms and Conditions Agreement.....</b>	<b>10</b>
<b>Safety Precautions.....</b>	<b>12</b>
Definition of Precautionary Information.....	12
Symbols .....	12
WARNING.....	12
Cautions.....	13
<b>Regulations and Standards .....</b>	<b>15</b>
Software Licenses and Copyrights .....	15
<b>Versions .....</b>	<b>16</b>
<b>Related Manuals.....</b>	<b>17</b>
<b>Terminology.....</b>	<b>19</b>
<b>Revision History.....</b>	<b>21</b>

## Section 1 Features and Specifications

---

<b>1-1 Introduction .....</b>	<b>1-2</b>
<b>1-2 Features .....</b>	<b>1-3</b>
<b>1-3 Robot Integrated System .....</b>	<b>1-4</b>
<b>1-4 Specifications.....</b>	<b>1-6</b>
1-4-1 Product Model Numbers .....	1-6
1-4-2 Supported Languages.....	1-6
1-4-3 Applicable Models .....	1-7
1-4-4 Applicable Computers .....	1-7

## Section 2 Software Setup

---

<b>2-1 Installing the Sysmac Studio .....</b>	<b>2-2</b>
---	------------

## Section 3 Building the Robot Integrated System

---

<b>3-1 Robot Integrated System Type .....</b>	<b>3-2</b>
<b>3-2 Basic Flow of System Design .....</b>	<b>3-3</b>



## Section 4 System Design

<b>4-1</b>	<b>Starting and Exiting the Sysmac Studio.....</b>	<b>4-2</b>
4-1-1	Starting the Sysmac Studio.....	4-2
4-1-2	Exiting the Sysmac Studio.....	4-3
<b>4-2</b>	<b>Creating a Project.....</b>	<b>4-4</b>
4-2-1	Creating a New Project.....	4-4
4-2-2	Robot Integrated CPU Unit Configuration.....	4-5
<b>4-3</b>	<b>Parts of the Window.....</b>	<b>4-7</b>
4-3-1	Application Window.....	4-7
4-3-2	Project Shortcut View.....	4-8
4-3-3	Edit Pane.....	4-8
4-3-4	Toolbox.....	4-8
4-3-5	Search and Replace Pane.....	4-8
4-3-6	Task Status Control Pane.....	4-8
4-3-7	3D Visualizer.....	4-8
4-3-8	V+ Jog Control Pane.....	4-9
4-3-9	Build Tab Page.....	4-9
4-3-10	V+ Watch Tab Page.....	4-9
4-3-11	System Monitor Pane.....	4-9
<b>4-4</b>	<b>Using Online and Offline Modes of the Sysmac Studio.....</b>	<b>4-10</b>

## Section 5 Configurations and Settings of the Controller

<b>5-1</b>	<b>Configurations and Settings of the Controller.....</b>	<b>5-2</b>
<b>5-2</b>	<b>EtherCAT Settings.....</b>	<b>5-3</b>
<b>5-3</b>	<b>I/O Settings.....</b>	<b>5-4</b>
5-3-1	How to Assign V+ Digital I/O.....	5-4
5-3-2	V+ Digital I/O Settings.....	5-4
<b>5-4</b>	<b>Robot Integrated CPU Unit Settings.....</b>	<b>5-6</b>
5-4-1	Robot Common Settings.....	5-6
5-4-2	Robot Settings.....	5-8
<b>5-5</b>	<b>Robot Subdevice Settings.....</b>	<b>5-9</b>
5-5-1	Controller Settings.....	5-9
5-5-2	Save Configuration.....	5-21
5-5-3	Monitor Window.....	5-22
<b>5-6</b>	<b>Robot Settings.....</b>	<b>5-24</b>
5-6-1	Robot Settings Tab Page.....	5-24
5-6-2	How to Display Robot Settings Tab Page.....	5-27
5-6-3	Configure.....	5-27
5-6-4	IO EndEffectors.....	5-32

## Section 6 Programming

<b>6-1</b>	<b>Creating Programs.....</b>	<b>6-2</b>
<b>6-2</b>	<b>Creating V+ Programs.....</b>	<b>6-3</b>
6-2-1	Structure of V+ Program.....	6-3
6-2-2	Registering V+ Variables.....	6-3
6-2-3	Creating New V+ Programs.....	6-10
6-2-4	V+ Program Editor.....	6-12
<b>6-3</b>	<b>Task Settings.....</b>	<b>6-16</b>

## Section 7 Debugging Robot Integrated System

<b>7-1</b>	<b>Overview of Debugging Robot Integrated System</b> .....	<b>7-3</b>
7-1-1	Schema of V+ Program Offline Debug .....	7-3
<b>7-2</b>	<b>3D Visualizer</b> .....	<b>7-4</b>
7-2-1	3D Visualizer Basic Features .....	7-4
7-2-2	Creating 3D Workspace .....	7-4
7-2-3	Description of Icons .....	7-4
7-2-4	Collision Detection Settings .....	7-19
<b>7-3</b>	<b>V+ Jog Control</b> .....	<b>7-20</b>
7-3-1	Starting V+ Jog Control .....	7-20
7-3-2	V+ Jog Control Setting Items .....	7-21
<b>7-4</b>	<b>Task Status Control</b> .....	<b>7-28</b>
7-4-1	Starting Task Status Control .....	7-28
7-4-2	Displayed Items in Task Status Control .....	7-29
7-4-3	Robot Integrated CPU Unit Settings Items .....	7-31
7-4-4	Task Manager .....	7-31
7-4-5	IO Watcher .....	7-34
7-4-6	V+ File Browser .....	7-34
7-4-7	Virtual Front Panel .....	7-36
<b>7-5</b>	<b>Overview of Robot Integrated System Simulation</b> .....	<b>7-39</b>
7-5-1	Schema of Robot Integrated System Simulation .....	7-39
<b>7-6</b>	<b>How to Start Simulation</b> .....	<b>7-41</b>
7-6-1	Activating Robot Simulation Function .....	7-41
7-6-2	Starting Robot Simulation .....	7-42
<b>7-7</b>	<b>Teaching Robots</b> .....	<b>7-43</b>
7-7-1	Preparing V+ Location Variables .....	7-43
7-7-2	Teaching on 3D Visualizer .....	7-43
7-7-3	Teaching on V+ Jog Control Pane .....	7-47
7-7-4	Saving Current Robot Position .....	7-50
7-7-5	Teaching with Robot Path Planning .....	7-52
<b>7-8</b>	<b>Debugging Robot Movement</b> .....	<b>7-59</b>
7-8-1	Commissioning the Robot .....	7-59
<b>7-9</b>	<b>Program Debugging</b> .....	<b>7-61</b>
7-9-1	Variable Monitoring .....	7-61
7-9-2	Program Debugging .....	7-61
7-9-3	System Monitor .....	7-62
<b>7-10</b>	<b>Transferring V+ Programs and V+ Variables</b> .....	<b>7-64</b>
7-10-1	Checking the V+ Memory .....	7-64
7-10-2	Synchronization .....	7-64
7-10-3	Writing Data to the V+ Memory .....	7-68
7-10-4	Getting Data from the V+ Memory .....	7-69
7-10-5	Notes on Transferring V+ Variables .....	7-70

## Section 8 Connection and Transfer to Physical Controller

<b>8-1</b>	<b>Connection and Transfer to the Robot Integrated CPU Unit</b> .....	<b>8-2</b>
8-1-1	Connection Type .....	8-2
8-1-2	Connection to the Robot Integrated CPU Unit .....	8-2
8-1-3	Transferring the Project .....	8-2
<b>8-2</b>	<b>Robot System Operation Authority Verification</b> .....	<b>8-8</b>
8-2-1	Robot Integrated CPU Unit Operation Authority .....	8-8
8-2-2	User Setting .....	8-8
8-2-3	Sign In/Sign Out .....	8-11
8-2-4	Operations when Both the Robot System Operation Authority Verification and the Controller Online Operation Authority Verification Are Set .....	8-13

<b>8-3</b>	<b>Checking Operation after Transfer</b> .....	<b>8-14</b>
8-3-1	Online Debugging .....	8-14
8-3-2	Robot Power Turned ON.....	8-17
8-3-3	Teaching.....	8-17
8-3-4	Online Editing.....	8-18

## Section 9 Maintenance

---

<b>9-1</b>	<b>Troubleshooting</b> .....	<b>9-2</b>
9-1-1	Outline of Troubleshooting and Maintenance Functions.....	9-2
9-1-2	Events in the Robot Integrated CPU Unit.....	9-2
<b>9-2</b>	<b>Backup and Restore</b> .....	<b>9-4</b>

## Section 10 Other Functions

---

<b>10-1</b>	<b>Printing</b> .....	<b>10-2</b>
10-1-1	Items You Can Print .....	10-2
<b>10-2</b>	<b>Hardware Diagnostics</b> .....	<b>10-3</b>
<b>10-3</b>	<b>Data Collection</b> .....	<b>10-5</b>
<b>10-4</b>	<b>Motor Tuning</b> .....	<b>10-7</b>
<b>10-5</b>	<b>Searching and Replacing</b> .....	<b>10-8</b>
10-5-1	Scope of Searching and Replacing and Setting Items.....	10-8
<b>10-6</b>	<b>V+ Version Configuration</b> .....	<b>10-9</b>
10-6-1	Checking V+ Versions .....	10-9
10-6-2	Renewing V+ Versions.....	10-11

## Appendices

---

<b>A-1</b>	<b>Option Settings</b> .....	<b>A-2</b>
A-1-1	Display the Option Settings.....	A-2
A-1-2	Option Setting Items.....	A-2
<b>A-2</b>	<b>Version Control Function</b> .....	<b>A-4</b>
A-2-1	Precautions Common to All Devices.....	A-4
A-2-2	Robot Integrated CPU Unit .....	A-4
A-2-3	Application Manager .....	A-5

## Index

---

# Terms and Conditions Agreement

---

## WARRANTY

---

- The warranty period for the Software is one year from the date of purchase, unless otherwise specifically agreed.
- If the User discovers defect of the Software (substantial non-conformity with the manual), and return it to OMRON within the above warranty period, OMRON will replace the Software without charge by offering media or download from OMRON's website. And if the User discovers defect of media which is attributable to OMRON and return it to OMRON within the above warranty period, OMRON will replace defective media without charge. If OMRON is unable to replace defective media or correct the Software, the liability of OMRON and the User's remedy shall be limited to the refund of the license fee paid to OMRON for the Software.

## LIMITATION OF LIABILITY

---

- THE ABOVE WARRANTY SHALL CONSTITUTE THE USER'S SOLE AND EXCLUSIVE REMEDIES AGAINST OMRON AND THERE ARE NO OTHER WARRANTIES, EXPRESSED OR IMPLIED, INCLUDING BUT NOT LIMITED TO, WARRANTY OF MERCHANTABILITY OR FITNESS FOR PARTICULAR PURPOSE. IN NO EVENT, OMRON WILL BE LIABLE FOR ANY LOST PROFITS OR OTHER INDIRECT, INCIDENTAL, SPECIAL OR CONSEQUENTIAL DAMAGES ARISING OUT OF USE OF THE SOFTWARE.
- OMRON SHALL HAVE NO LIABILITY FOR DEFECT OF THE SOFTWARE BASED ON MODIFICATION OR ALTERNATION TO THE SOFTWARE BY THE USER OR ANY THIRD PARTY. OMRON SHALL NOT BE RESPONSIBLE AND/OR LIABLE FOR ANY LOSS, DAMAGE, OR EXPENSES DIRECTLY OR INDIRECTLY RESULTING FROM THE INFECTION OF OMRON PRODUCTS, ANY SOFTWARE INSTALLED THEREON OR ANY COMPUTER EQUIPMENT, COMPUTER PROGRAMS, NETWORKS, DATABASES OR OTHER PROPRIETARY MATERIAL CONNECTED THERETO BY DISTRIBUTED DENIAL OF SERVICE ATTACK, COMPUTER VIRUSES, OTHER TECHNOLOGICALLY HARMFUL MATERIAL AND/OR UNAUTHORIZED ACCESS.
- OMRON SHALL HAVE NO LIABILITY FOR SOFTWARE DEVELOPED BY THE USER OR ANY THIRD PARTY BASED ON THE SOFTWARE OR ANY CONSEQUENCE THEREOF.

## APPLICABLE CONDITIONS

---

USER SHALL NOT USE THE SOFTWARE FOR THE PURPOSE THAT IS NOT PROVIDED IN THE ATTACHED USER MANUAL.

## CHANGE IN SPECIFICATION

---

The software specifications and accessories may be changed at any time based on improvements and other reasons.

## **ERRORS AND OMISSIONS**

---



The information in this manual has been carefully checked and is believed to be accurate; however, no responsibility is assumed for clerical, typographical, or proofreading errors, or omissions.

# Safety Precautions

## Definition of Precautionary Information



The following notation is used in this manual to provide precautions required to ensure safe usage of the Sysmac Studio. The safety precautions that are provided are extremely important to safety. Always read and heed the information provided in all safety precautions.

The following notation is used.

 <b>WARNING</b>	Indicates a potentially hazardous situation which, if not avoided, could result in death or serious injury. Additionally, there may be severe property damage.
 <b>CAUTION</b>	Indicates a potentially hazardous situation which, if not avoided, may result in minor or moderate injury, or property damage.

## Symbols



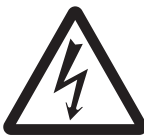

The  symbol indicates operations that you must not do.  
 The specific operation is shown in the  symbol and explained in text.  
 This example indicates prohibiting disassembly.

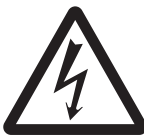
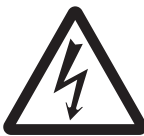



The  symbol indicates precautions (including warnings).  
 The specific operation is shown in the  symbol and explained in text.  
 This example indicates a precaution for electric shock.



The  symbol indicates precautions (including warnings).  
 The specific operation is shown in the  symbol and explained in text.  
 This example indicates a general precaution.



The  symbol indicates operations that you must do.  
 The specific operation is shown in the  symbol and explained in text.  
 This example shows a general precaution for something that you must do.

## WARNING

# **WARNING**

Check operations of the created user programs, data, and setting values carefully before proceeding to normal operation.



When building a robot system that includes this CPU Unit or an Omron robot, be sure to ensure compliance with the laws and regulations on the safety of industrial robots in the country or region where the robot is operating in design and operation of the system. Refer to *Robot Safety Guide (Cat. No. I590)* for details.



Ensure the enough safety before making any changes that may affect the operation of the robot.



Make sure that there are no hazards caused by robot's movements before operating the robot using the V+ Jog Control function.



Take a particular attention to the robot speed setting when you operate the robot using the V+ Jog Control function. Get ready to bring the robot to an emergency stop at an emergency. Make sure that there are no hazards caused by robot's movements before operating the robot.



Confirm that you are operating the right robot before conducting a jog operation using V+ Jog Control function.



If an execution program and task number are specified and the automatic execution of V+ program is enabled, it may possibly happen that the robot operates after the CPU Unit and robot are turned on. Make sure that the movement of the robot does not cause a danger.



To prevent computer viruses, install antivirus software on a computer where you use this software. Make sure to keep the antivirus software updated.



Keep your computer's OS updated to avoid security risks caused by a vulnerability in the OS.



Always use the highest version of this software to add new features, increase operability, and enhance security.



Manage usernames and passwords for this software carefully to protect them from unauthorized uses.



Set up a firewall (E.g., disabling unused communication ports, limiting communication hosts, etc.) on a network for a control system and devices to separate them from other IT networks. Make sure to connect to the control system inside the firewall.



Use a virtual private network (VPN) for remote access to a control system and devices from this software.



## Cautions



## Caution

---

The simulator, which uses the 3D Visualizer, simulates the operations of a PLC and a robot. There are differences in movement and timing between actual PLC and robot. In addition to debugging the program in the simulator, be sure to check the operation on the physical machine before operating it. Unexpected operation of the equipment may occur an accident.

---





# Regulations and Standards

---

## Software Licenses and Copyrights

This product incorporates certain third party software. The license and copyright information associated with this software is available at [http://www.fa.omron.co.jp/nj\\_info\\_e/](http://www.fa.omron.co.jp/nj_info_e/).

# Versions

---

Hardware revisions and unit versions are used to manage the hardware and software in NJ/NX-series Units, NY-series Industrial PCs, and EtherCAT slaves.

Refer to *Sysmac Studio Version 1 Operation Manual (Cat. No. W504)* for details on versions.

# Related Manuals

The followings are the manuals related to this manual. Use these manuals for reference.

Manual name	Cat. No.	Model numbers	Application	Description
Sysmac Studio Version 1 Operation Manual	W504	SYSMAC-SE2□□□	Learning about the operating procedures and functions of the Sysmac Studio.	Describes the operating procedures of the Sysmac Studio.
Sysmac Studio Robot Integrated System Building Function with Robot Integrated CPU Unit Operation Manual	W595	SYSMAC-SE2□□□ SYSMAC-SE200D-64	Learning about the operating procedures and functions of the Sysmac Studio to configure Robot Integrated System using Robot Integrated CPU Unit.	Describes the operating procedures of the Sysmac Studio for Robot Integrated CPU Unit.
Sysmac Studio Robot Integrated System Building Function with IPC Application Controller Operation Manual	W621	SYSMAC-SE2□□□ SYSMAC-SE200D-64	Learning about the operating procedures and functions of the Sysmac Studio to configure Robot Integrated System using IPC Application Controller.	Describes the operating procedures of the Sysmac Studio for IPC Application Controller.
Sysmac Studio 3D Simulation Function Operation Manual	W618	SYSMAC-SE2□□□ SYSMAC-SA4□□ □-64	Learning about an outline of the 3D simulation function of the Sysmac Studio and how to use the function.	Describes an outline, execution procedures, and operating procedures for the 3D simulation function of the Sysmac Studio.
Sysmac Studio Project Version Control Function Operation Manual	W589	SYSMAC-SE2□□□ SYSMAC-TA4□□□	Learning about the Sysmac Studio project version control function and its operating procedures.	Provides an introduction to the Sysmac Studio project version control function along with its installation method, basic operations, execution method for the main functions, and other information.
NJ-series Robot Integrated CPU Unit User's Manual	O037	NJ501-R□□□	Using the NJ-series Robot Integrated CPU Unit.	Describes the settings and operation of the CPU Unit and programming concepts for OMRON robot control.

Manual name	Cat. No.	Model numbers	Application	Description
NJ/NX-series CPU Unit Software User's Manual	W501	NX701-□□□□ NX502-□□□□ NX102-□□□□ NX1P2-□□□□ NJ501-□□□□ NJ301-□□□□ NJ101-□□□□	Learning how to program and set up an NJ/NX-series CPU Unit. Mainly software information is provided.	The following information is provided on a Controller built with an NJ/NX-series CPU Unit. <ul style="list-style-type: none"> <li>• CPU Unit operation</li> <li>• CPU Unit features</li> <li>• Initial settings</li> <li>• Programming based on IEC 61131-3 language specifications</li> </ul>
NJ/NX-series Troubleshooting Manual	W503	NX701-□□□□ NX502-□□□□ NX102-□□□□ NX1P2-□□□□ NJ501-□□□□ NJ301-□□□□ NJ101-□□□□	Learning about the errors that may be detected in an NJ/NX-series Controller.	Concepts on managing errors that may be detected in an NJ/NX-series Controller and information on individual errors are described.
eV+3 User's Manual	I651	NJ501-R□□□	Operating the OMRON robot with the V+ program.	Describes the V+ language to control the OMRON robots.
eV+3 Keyword Reference Manual	I652	NJ501-R□□□	Operating the OMRON robot with the V+ program.	Describes V+ keywords that are used in the V+ language.
Robot Safety Guide	I590	RL4-□□□□□□□□ RS4-□□□□□□□□ RL6-□□□□□□□□ RX3-□□□□□□□□ RX4-□□□□□□□□	Learning how to use the OMRON robot safely.	Describes how to use the OMRON robot safely.
Teaching Pendant T20 User's Manual	I601	10046-010	Operating the OMRON robot with a teaching pendant.	Describes the setup, operation, and user maintenance for the Teaching Pendant T20.

# Terminology

The following describes the terms used in this manual.

Term	Description
IPC Application Controller	A PC-based controller with the ACE (Automation Control Environment) software package installed to manage multiple OMRON robots and recipes controlled by the Robot Integrated CPU Unit. It can perform image processing by using an image sensor.
Robot Integrated CPU Unit	A CPU Unit that supports control function for the OMRON robot with the NJ-series CPU Unit.
Robot subdevice	Subdevice that manages robot control functions of the Robot Integrated CPU Unit. Displayed in the Multiview Explorer device list in Sysmac Studio. It includes controller settings, robot settings, V+ programs, and V+ variables of Robot Control Function Modules.
RobotControl-Settings	A robot subdevice. Shown as RobotControlSettings in Sysmac Studio's Multiview Explorer.
V+	An operating system that controls OMRON robots. V+ programs run on it.
V+ version	Version of the V+ operating system that runs on a Robot Integrated CPU Unit or OMRON robot.
V+ version configuration	Function that sets the configured V+ versions of the Robot Integrated CPU Unit and OMRON robots to the same version number so that they can run together.
configured V+ version	A V+ version that is set by the V+ version configuration function. It is set for both the Robot Integrated CPU Unit and an OMRON robot.
V+ language	A programming language for OMRON robot control.
V+ program	A control program written in the V+ language.
V+ variable	Variable used in a V+ program.
V+ Digital I/O	Digital I/Os in the V+ Memory, which allocated to I/Os in a unit attached to the Robot Integrated CPU Unit. Making settings in I/O Map or V+ Digital I/O Settings in Sysmac Studio allows a V+ program to access to I/Os in a unit attached to the Robot Integrated CPU Unit.
V+ Memory	Memory that the Robot Subdevice manages. It consists of V+ programs, V+ variables, and digital I/Os.
Remote Encoder Latch	The setting allows to refer motion control axes of the Robot Integrated CPU Unit from a V+ program as external encoders for robot control. You can set a motion control axis and latch signal number to an encoder ID.
sequence control program	A control program written in IEC 61131-3 language including the motion control.
Robot Control Function Module	Software to perform robot control that is installed in the Robot Integrated CPU Unit.
IO EndEffector	Device for picking, placing, or material applying, attached on a robot's tip.
Emulation mode	Mode for a robot simulation on Sysmac Studio using the Robot Integrated CPU Unit. Select <b>Emulation Mode</b> to open a project.
Application Manager	Device that manages settings and programs of an IPC Application Controller, which controls a robot integrated system, and necessary data and settings for the 3D simulation function. Refer to the <i>Sysmac Studio Robot Integrated System Building Function with IPC Application Controller Operation Manual (Cat. No. W621)</i> for Application Manager functions for controlling a robot integrated system. Refer to the <i>Sysmac Studio 3D Simulation Function Operation Manual (Cat. No. W618)</i> for Application Manager functions for 3D simulation.
CAD data	3D CAD data for equipment or a part, which becomes the basis of 3D shape data. Use third party 3D CAD software to create CAD data. You can load CAD data files with a .stp, .step, .igs, or .iges extension.

Term	Description
Event Log	Displays a log of events that have occurred since the Robot Integrated System was started. Events are categorized as Error, Warning, and Information and can be used for troubleshooting and diagnostics.
3D Visualizer	The 3D Visualizer allows you to see simulated 3D motions of fixed objects (e.g. robot, rack), obstacles, mechanical components, and parts, which located on the screen.
V+ Jog Control	A function to operate an actual robot or a robot in a simulation in the jog mode.
Task Status Control	A group of functions to monitor and control all the robots in a robot integrated system. It allows you to display and change a connection to a robot controller, power status, monitoring speed, and execution statuses of Vision Sequences, C# programs, Process Managers, V+ programs, and more.

# Revision History

A manual revision code appears as a suffix to the catalog number on the front and back covers of the manual.

**Cat. No. W595-E1-08**

↑  
Revision code

Revision code	Date	Revised content
01	August 2020	Original production
02	January 2021	Revisions for an upgrade to Sysmac Studio version 1.44.
03	April 2021	Revisions for an upgrade to Sysmac Studio version 1.45.
04	October 2021	Revisions for an upgrade to Sysmac Studio version 1.47.
05	April 2022	Revisions for an upgrade to Sysmac Studio version 1.49.
06	July 2022	Revisions for an upgrade to Sysmac Studio version 1.50.
07	October 2022	Revisions for an upgrade to Sysmac Studio version 1.52.
08	April 2023	Revisions for an upgrade to Sysmac Studio version 1.54.





# 1

## Features and Specifications

This section provides an overview and lists the specifications and features of the Sysmac Studio Robot Integrated System Building Function.

---

<b>1-1</b>	<b>Introduction .....</b>	<b>1-2</b>
<b>1-2</b>	<b>Features .....</b>	<b>1-3</b>
<b>1-3</b>	<b>Robot Integrated System.....</b>	<b>1-4</b>
<b>1-4</b>	<b>Specifications .....</b>	<b>1-6</b>
1-4-1	Product Model Numbers.....	1-6
1-4-2	Supported Languages .....	1-6
1-4-3	Applicable Models .....	1-7
1-4-4	Applicable Computers .....	1-7

# 1-1 Introduction

---

The Sysmac Studio Robot Integrated System Building Function is a software function that helps you build an automated system with robots.

It includes the following functions and supports the building of a system with robots in a broad range of phases, from planning to design, maintenance, and product type change.

- Wizards that easily help you build automated systems with robots
- Automated system simulations that include robots, conveyors, and peripheral devices such as cameras
- Various programming
- Recipes for product type changes

The Sysmac Studio Robot Integrated System Building Function supports systems based on the NJ-series Robot Integrated CPU Units, which consist of OMRON robots, conveyors, the IPC Application Controller with the Application Manager, Feeders, OMRON cameras, sensors, and so on.

## 1-2 Features

The Sysmac Studio Robot Integrated System Building Function provides the following features.

### Easy System Building with Wizards

The Sysmac Studio Robot Integrated System Building Function provides the *application sample wizard* that helps you build systems with robots easily.

You can just select and set up components such as robots, Feeders, cameras, and conveyors according to the wizard instructions to easily build a pick-and-place system or the like.

This enables smooth system building because you can visually determine the positions of robots and the image capture positions of cameras.

### Offline Check of the Entire System with Simulation

The Sysmac Studio Robot Integrated System Building Function has the entire system simulation functions. And you can use the Pack Manager Application sample wizard on the computer to check the operation of the automated pick-and-place system that you have built. You can also check the operations of systems that consist of robots, End-Effectors, cameras, Feeders, and conveyors in the 3D Visualizer, and estimate the takt time by checking the interference between the robots and peripheral devices and simulating the cooperative operation with parts.

These allow you to check the feasibility of the entire system requirements without having a complete set of physical components.

In addition, you can simulate the system operation for product type changes of parts. This enables early decision on investment in introducing robots into a multi-product, variable-volume production system that is difficult to automate.

### Setup and Programming of System Configuration Devices with Single Support Software

The Sysmac Studio can be used for setting up and programming not only the controller to control peripheral devices, but also peripheral devices as conveyors, robots, Feeders, sensors, and HMI. You can use only the Sysmac Studio to set up system configuration devices, instead of using separate Support Software for each device.

### Easy Change of the Product Type

When you modify a system to change the product type, you can use the wizard to add or change the peripheral devices easily and then perform simulation to check the operation of the system.

In addition, you can manage the setup data for changing the product type as recipe data, which facilitates changing the product type in the physical system.

# 1-3 Robot Integrated System

The Sysmac Studio Robot Integrated System Building Function covers robot control systems as shown below.

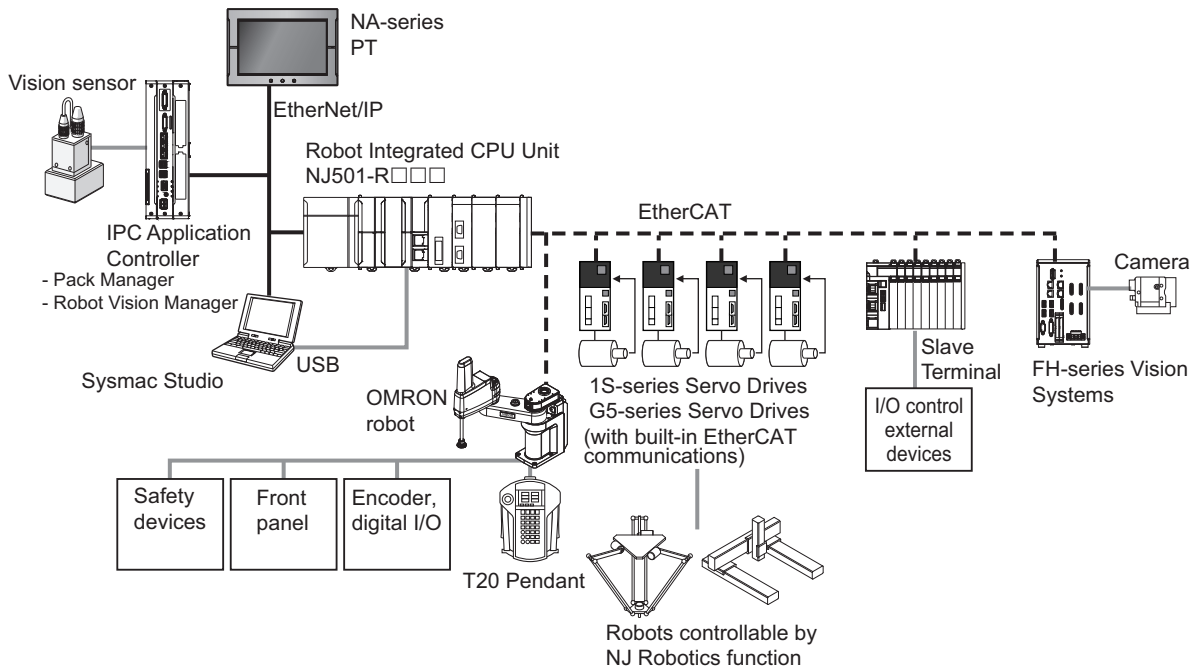

Component		Description
Robot Integrated CPU Unit		The Robot Integrated CPU Unit provides the functionality of previous OMRON PLCs and also the functionality that is required for robot control. Control of I/O devices on high-speed EtherCAT can be applied to robots, safety devices, vision systems, motion equipment, discrete I/O, and more.
Sysmac Studio		The Sysmac Studio provides a wizard for building the basic configuration of a robot integrated system and generating process data and recipe data that Pack Manager uses to control the system. The generated process data and recipe data are then transferred to the IPC Application Controller for execution by Pack Manager. It is also used for setting up cameras and Vision Systems. The setup data is then transferred to the IPC Application Controller for execution by Robot Vision Manager.
IPC Application Controller	Pack Manager	The Pack Manager application controls automated pick-and-place systems with cameras, conveyors, and robots based on the data that you set up in the Sysmac Studio. It is executed on the IPC Application Controller to control the process data and recipe data.
	Robot Vision Manager	The Robot Vision Manager application processes images captured by cameras based on the data that you set up in the Sysmac Studio. It is executed on the IPC Application Controller.
OMRON robot		Consists of the robot amplifier and the robot arm connected to the robot amplifier. It connects with a Robot Integrated CPU Unit through EtherCAT communications. It has digital I/O ports to enable control for the external devices.

Component	Description
Vision sensor	Cameras that capture part images. You can use cameras made by OMRON SENTECH or Basler. The captured images are processed by the Robot Vision Manager installed on the IPC Application Controller based on the settings in the Sysmac Studio. You can also use FH-series Vision Sensors.
NA-series PT	Displays various information and performs operation as required. It is used when you instruct a recipe change to the Robot Integrated CPU Unit.
T20 Pendant	The pendant is used to directly operate robot arms. It is also used to teach robots.
1S-series Servo Drives G5-series Servo Drives	Servo Drives with built-in EtherCAT communications.
Robots controllable by NJ Robotics function	Robots that can be controlled from the Robot Integrated CPU Unit that controls Servomotors/Servo Drives with built-in EtherCAT communications.
Slave Terminal	Consists of the NX-ECC20□ Communications Coupler Unit and NX Units that are connected to EtherCAT communications. It exchanges I/O data with a Robot Integrated CPU Unit through EtherCAT communications. Various Units such as digital I/O, analog I/O are covered, therefore, you can use the NX Units depending on the system demand.
FH-series Vision Systems	Vision systems connected to the EtherCAT communications.
Front panel	Changes the operating mode of OMRON robot and executes an emergency stop.

# 1-4 Specifications

## 1-4-1 Product Model Numbers

The Sysmac Studio Robot Integrated System Building Function supports Sysmac Studio (64 bit) version 1.42 or higher.

To use the Sysmac Studio Robot Integrated System Building Function, the following Sysmac Studio licenses are needed. In addition to the above, to execute the 3D simulation of the Mechanical Component, the following Sysmac Studio option licenses are needed.

To install the Sysmac Studio (64 bit), the following DVD is needed.



### Additional Information

Even when you have not registered the Sysmac Studio 3D Simulation Option license number, you can use the Robot Integrated System Building Function.

### ● Sysmac Studio License

Product name	Number of licenses	Model number
Sysmac Studio Standard Edition Ver.1.□□	1 license	SYSMAC-SE201L
	3 licenses	SYSMAC-SE203L
	10 licenses	SYSMAC-SE210L
	30 licenses	SYSMAC-SE230L
	50 licenses	SYSMAC-SE250L

### ● Sysmac Studio Option License

Product name	Number of licenses	Model number
Sysmac Studio 3D Simulation Option	1 license	SYSMAC-SA401L-64
	3 licenses	SYSMAC-SA403L-64
	10 licenses	SYSMAC-SA410L-64
	30 licenses	SYSMAC-SA430L-64
	50 licenses	SYSMAC-SA450L-64

### ● DVD

Product name	Media	Model number
Sysmac Studio Standard Edition Ver.1.□□	64-bit edition DVD	SYSMAC-SE200D-64

## 1-4-2 Supported Languages

The supported languages conform to the specifications of the Sysmac Studio. Refer to *Sysmac Studio Version 1 Operation Manual (Cat. No. W504)* for details.

### 1-4-3 Applicable Models

The Sysmac Studio Robot Integrated System Building Function can be used with the following models.

- Robot Integrated CPU Unit NJ501-R□□□

Refer to the *NJ-series Robot Integrated CPU Unit User's Manual (Cat. No. O037)* for devices controlled by the Robot Integrated CPU Unit.

### 1-4-4 Applicable Computers

The computer on which the Sysmac Studio (64 bit) can be installed. Refer to the *Sysmac Studio Version 1 Operation Manual (Cat. No. W504)* for details.

Refer to the *Sysmac Studio 3D Simulation Function Operation Manual (Cat. No. W618)* for recommended system requirements to use the 3D Simulation Option functions.





# 2

## Software Setup

This section describes the procedures for setting up the software to use the Sysmac Studio Robot Integrated System Building Function.

---

<b>2-1</b>	<b>Installing the Sysmac Studio .....</b>	<b>2-2</b>
------------	---	------------

## 2-1 Installing the Sysmac Studio

---

Install the Sysmac Studio from the DVD. For details of the installation procedure, refer to *Sysmac Studio Version 1 Operation Manual (Cat. No. W504)*.

# 3

## Building the Robot Integrated System

This section describes the Robot Integrated System targeted by the Sysmac Studio Robot Integrated System Building Function and the basic design flow of the Robot Integrated System.

---

<b>3-1</b>	<b>Robot Integrated System Type.....</b>	<b>3-2</b>
<b>3-2</b>	<b>Basic Flow of System Design .....</b>	<b>3-3</b>

## 3-1 Robot Integrated System Type

This manual describes how to operate the Sysmac Studio for the following Robot Integrated System examples.

Robot Integrated System example	Description	Center of control	Reference
Static pick-and-place system	A stationary part is picked by a robot and placed on another conveyor.	Robot Integrated CPU Unit	Refer to the 3-2 <i>Basic Flow of System Design</i> on page 3-3 or later.
Dynamic pick-and-place system	A part, on the moving conveyor, is detected by a camera or sensor, picked by the robot, and placed on another conveyor. A programless system is created by using the Pack Manager Application sample wizard.	IPC Application Controller	Refer to <i>Sysmac Studio Robot Integrated System Building Function with IPC Application Controller Operation Manual (Cat. No. W621)</i> for details on the function.

## 3-2 Basic Flow of System Design

The building procedures for the Robot Integrated System in the Sysmac Studio are as follows. Hereafter, operation procedures and functions are described according to this flow.

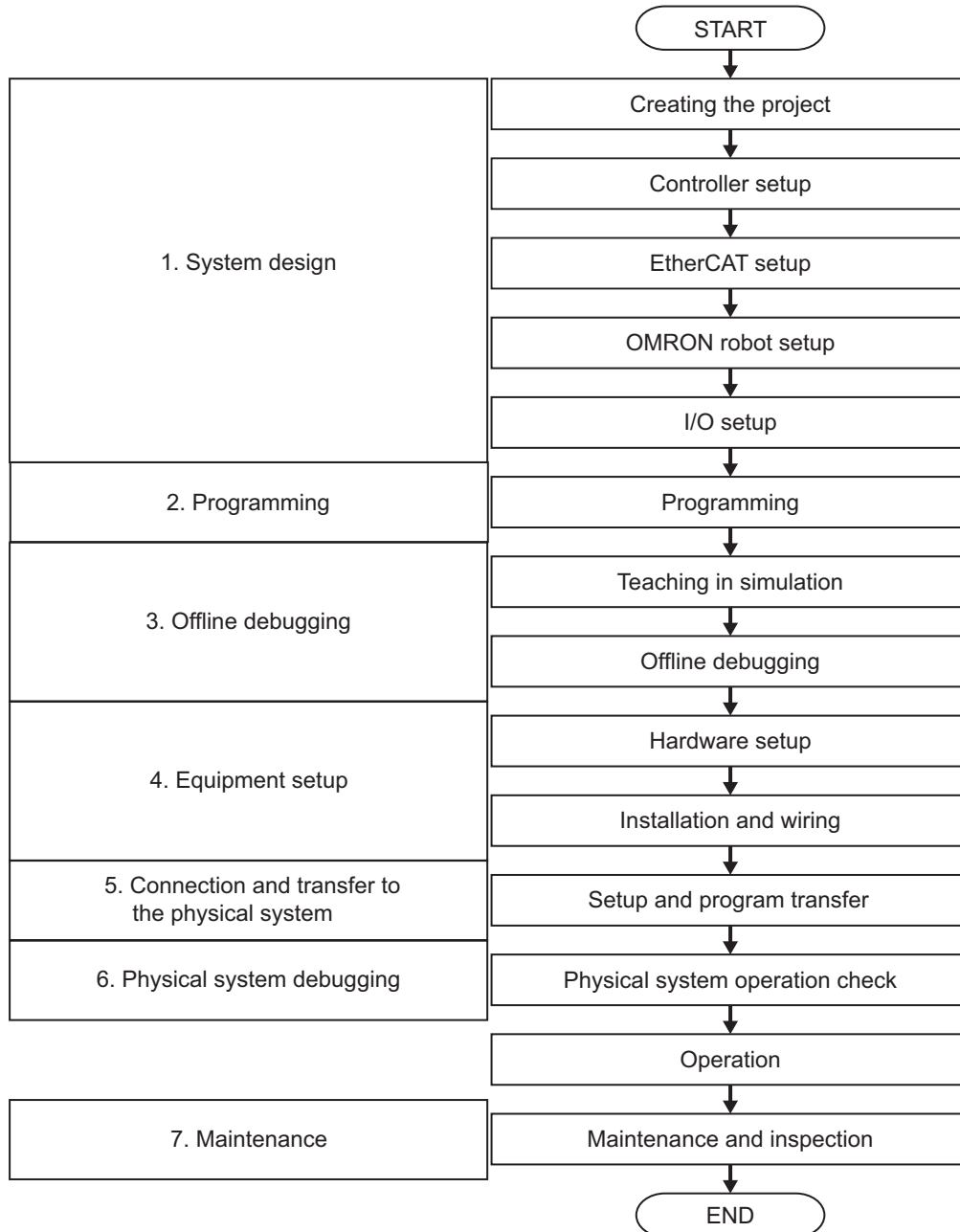

Procedure	Item		Description	Reference
1	System Design	New project creation	Creates a project for the Robot Integrated CPU Unit and adds a robot to the EtherCAT network.	<i>4-2-1 Creating a New Project</i> on page 4-4
		The Robot Integrated CPU Unit setup	Sets up the Robot Integrated CPU Unit for the robot control.	<i>5-4 Robot Integrated CPU Unit Settings</i> on page 5-6
		EtherCAT setup	Adds the EtherCAT slaves including the OMRON robots on the EtherCAT, and makes the settings.	<i>5-2 EtherCAT Settings</i> on page 5-3
		OMRON robot setup	Makes the robot control parameter settings.	<i>5-5 Robot Sub-device Settings</i> on page 5-9
		I/O setup	Makes the setting to control I/O from a user program.	<i>5-3 I/O Settings</i> on page 5-4
2	Programming	Programming	Writes the user program for the robot control. Writes the user program for OMRON robots with the sequence control program and the V+ program.	<i>Section 6 Programming</i> on page 6-1
3	Offline Debugging	Simulation of the Robot Integrated System	Simulates operations of the Robot Integrated System that includes robots and conveyor belts on the computer to debug the programs. Checks takt time and interference between a robot and peripheral equipment as required.	<i>Section 7 Debugging Robot Integrated System</i> on page 7-1
4	Equipment setup	Hardware setting, installation and wiring	Makes the settings for hardware switches on the equipment, installation and wiring for I/O and the network.	Refer to <i>NJ-series Robot Integrated CPU Unit User's Manual (Cat. No. O037)</i> and manuals for the OMRON robots that you use and the EtherCAT slaves.
5	Connection and transfer to the physical system	Connection and transfer to the Robot Integrated CPU Unit	Connect to the Robot Integrated CPU Unit online and transfer the Controller settings and programs.	<i>8-1 Connection and Transfer to the Robot Integrated CPU Unit</i> on page 8-2
6	Physical system debugging	Operation check on the physical system	Performs operations such as robot calibration and robot teaching on the physical system to check the system operation.	<i>8-3 Checking Operation after Transfer</i> on page 8-14
7	Maintenance	Troubleshooting	Checks the error information on the Controller and robot and acts according to the error if any device error occurs.	<i>9-1 Troubleshooting</i> on page 9-2

# 4

## System Design

This section describes the procedure to build a static pick-and-place system using the Robot Integrated CPU Unit in the Sysmac Studio.

4

---

<b>4-1</b>	<b>Starting and Exiting the Sysmac Studio .....</b>	<b>4-2</b>
4-1-1	Starting the Sysmac Studio .....	4-2
4-1-2	Exiting the Sysmac Studio.....	4-3
<b>4-2</b>	<b>Creating a Project .....</b>	<b>4-4</b>
4-2-1	Creating a New Project .....	4-4
4-2-2	Robot Integrated CPU Unit Configuration .....	4-5
<b>4-3</b>	<b>Parts of the Window.....</b>	<b>4-7</b>
4-3-1	Application Window .....	4-7
4-3-2	Project Shortcut View .....	4-8
4-3-3	Edit Pane.....	4-8
4-3-4	Toolbox .....	4-8
4-3-5	Search and Replace Pane .....	4-8
4-3-6	Task Status Control Pane .....	4-8
4-3-7	3D Visualizer .....	4-8
4-3-8	V+ Jog Control Pane .....	4-9
4-3-9	Build Tab Page .....	4-9
4-3-10	V+ Watch Tab Page.....	4-9
4-3-11	System Monitor Pane .....	4-9
<b>4-4</b>	<b>Using Online and Offline Modes of the Sysmac Studio .....</b>	<b>4-10</b>

# 4-1 Starting and Exiting the Sysmac Studio

This section describes the starting procedure to use the Robot Integrated CPU Unit in the Sysmac Studio.

For the basic operating procedure and precautions to start and exit the Sysmac Studio, refer to the *Sysmac Studio Version 1 Operation Manual (Cat. No. W504)*.

## 4-1-1 Starting the Sysmac Studio

You can perform a robot simulation for the Robot Integrated CPU Unit in the Sysmac Studio. Open a project in the *EMULATION mode*.

- 1 Start the Sysmac Studio and click **New Project** on the start page. If you open an existing project, click **Open Project** to select the target project.

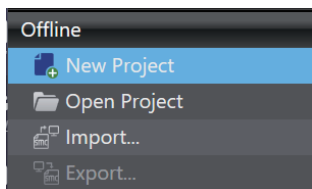

- 2 Select the **Open in Emulation Mode** check box under **Robot System** and click the **Create** button. If you open an existing project, click the **Open** button.

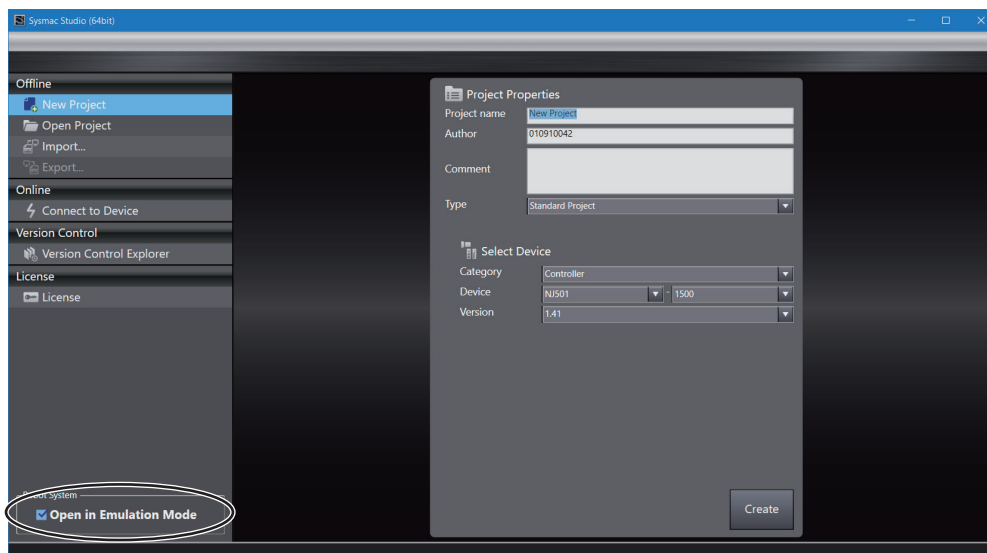

The project is opened in emulation mode.

At this time, the **Emulation Mode** is displayed in the status bar of the main Sysmac Studio window.



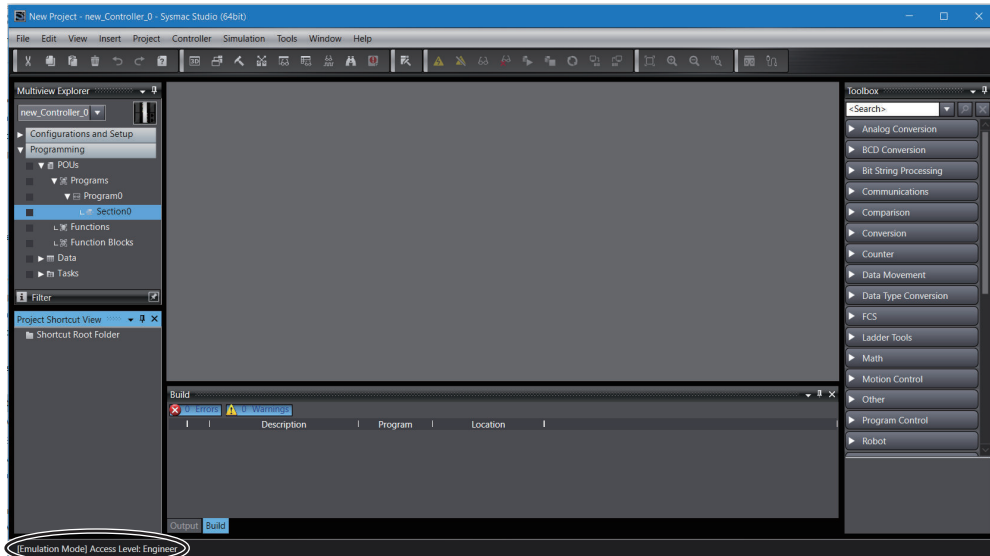

### Additional Information

- This option is valid only for the Robot Integrated CPU Unit.
- A project in the Robot Integrated System needs to run an emulator for the Robot Control Function Module, if you set up the Robot Control Function Module, edit the V+ program and perform offline debugging. Select the **Open in emulation mode** option to open a project.

Application	Open in emulation mode option
Setting up the Robot Control Function Module, editing V+ program and performing offline debugging	On
Physical component debugging, maintenance	Off

## 4-1-2 Exiting the Sysmac Studio

Use one of the following methods to exit the Sysmac Studio.

- Click the × button on the right end of the title bar.
- Select **File – Close** from the main menu.

## 4-2 Creating a Project

This section describes the procedure to create a project for the Robot Integrated CPU Unit and register a robot to use.

### 4-2-1 Creating a New Project

- 1 Select **New Project** on the Start menu of the Sysmac Studio. Then, select the Robot Integrated CPU Unit in **Select Device**.

In this example, select the Robot Integrated CPU Unit *NJ501-R500*.

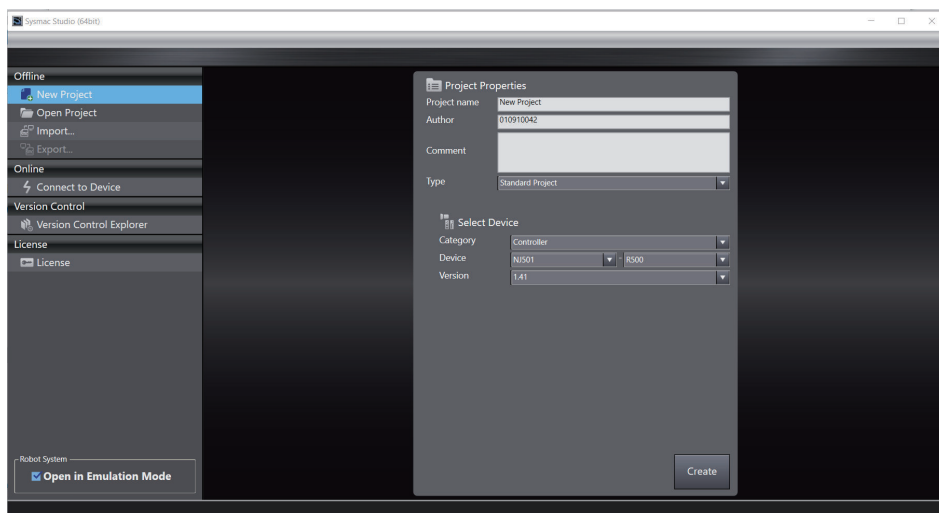

- 2 After entering data in the **Project Properties** dialog box, select **Open in Emulation Mode** check box and click the **Create** button. A new project is now created.

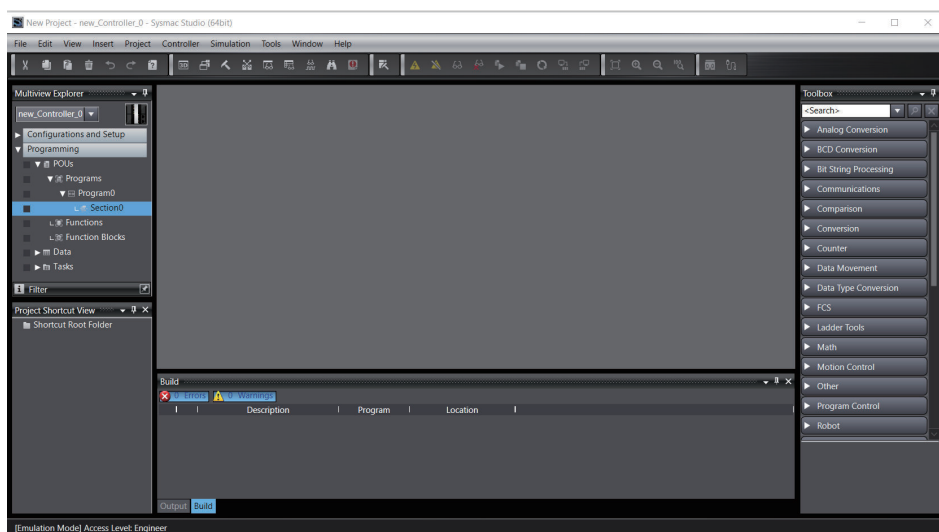

- 3 Display the EtherCAT tab page from **Configurations and Setup** in the Multiview Explorer, and register the robot to use.

In this example, select the OMRON SCARA robot *Cobra 600*. Refer to the *Sysmac Studio Version 1 Operation Manual (Cat. No. W504)* for details on the registration procedure of a device in the EtherCAT Tab Page.

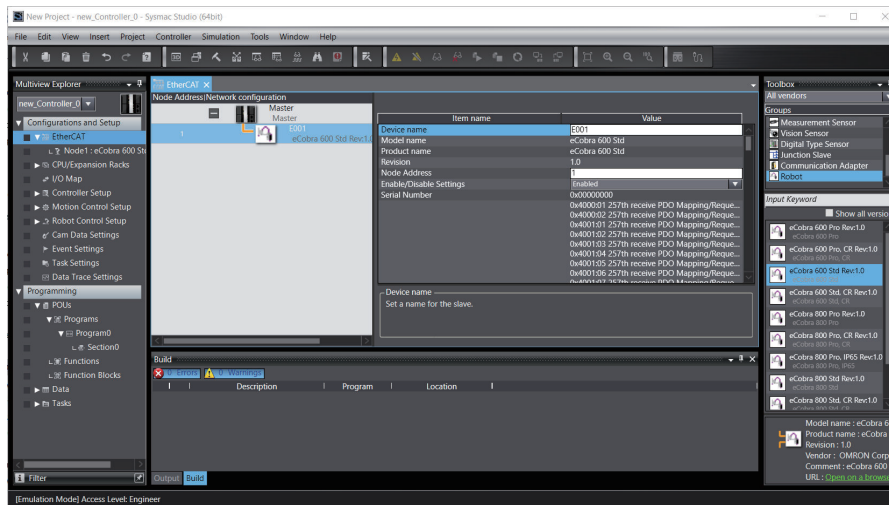

The robot is registered. The registered robot is displayed under **Configurations and Setup – Robot Control Setup – Robot Settings**.

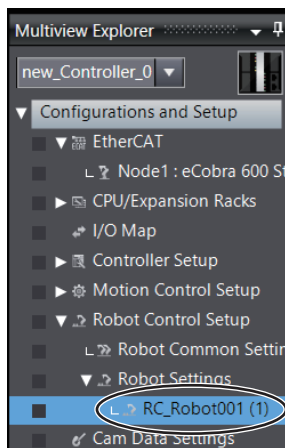

- 4 In the EtherCAT tab page, register the peripheral devices to connect to the EtherCAT network as required.  
Refer to the *Sysmac Studio Version 1 Operation Manual (Cat. No. W504)* for the registration procedure.

## 4-2-2 Robot Integrated CPU Unit Configuration

The Robot Integrated CPU Unit is equipped with the Robot Control Function Module. In the Sysmac Studio, the V+ program and the setting of the Robot Control Function Module are managed by the sub-device, *RobotControlSettings*.

The display method and items for the sub-device *RobotControlSettings* are as follows.

## Displaying the RobotControlSettings

- 1 Select the **RobotControlSettings** from the device list in the Multiview Explorer.

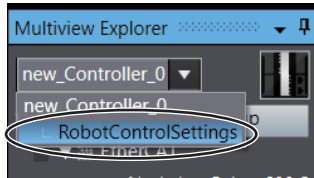

Items of **RobotControlSettings** are displayed in the Multiview Explorer.

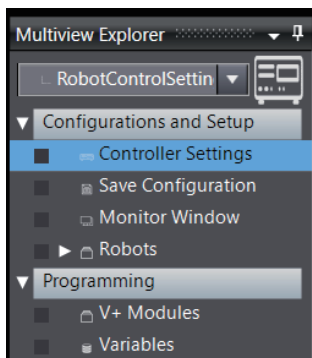

## Items of the RobotControlSettings

Items of the RobotControlSettings are as follows.

### ● Configurations and Setup

Item	Description	Reference
Controller Setup	This setup is for the Robot Control Function Module. Sets the IP address and other items required to connect to the Robot Control Function Module of the Robot Integrated CPU Unit.	5-5-1 <i>Controller Settings</i> on page 5-9
Save Configuration	Save Configuration is for saving belt calibration data, variables, and the V+ program that starts when the power supply is turned ON.	5-5-2 <i>Save Configuration</i> on page 5-21
Monitor Window	Displays the execution results of V+ monitor commands to the Robot Control Function Module.	5-5-3 <i>Monitor Window</i> on page 5-22
Robots	Displays registered robots.	5-6 <i>Robot Settings</i> on page 5-24

### ● Programming

Item	Description	Reference
V+ Modules	Display V+ programs.	6-2 <i>Creating V+ Programs</i> on page 6-3
Variables	Register variables to use in the V+ program.	6-2-2 <i>Registering V+ Variables</i> on page 6-3

## 4-3 Parts of the Window

This section gives the names of the parts of the Sysmac Studio Window.

This section also provides an overview of the windows and screens when you select *RobotControlSettings*, the sub-device of the Robot Integrated CPU Unit, is selected in the device list. Refer to the *Sysmac Studio Version 1 Operation Manual (Cat. No. W504)* for basic display explanations.

### 4-3-1 Application Window

This is the main Sysmac Studio Window.

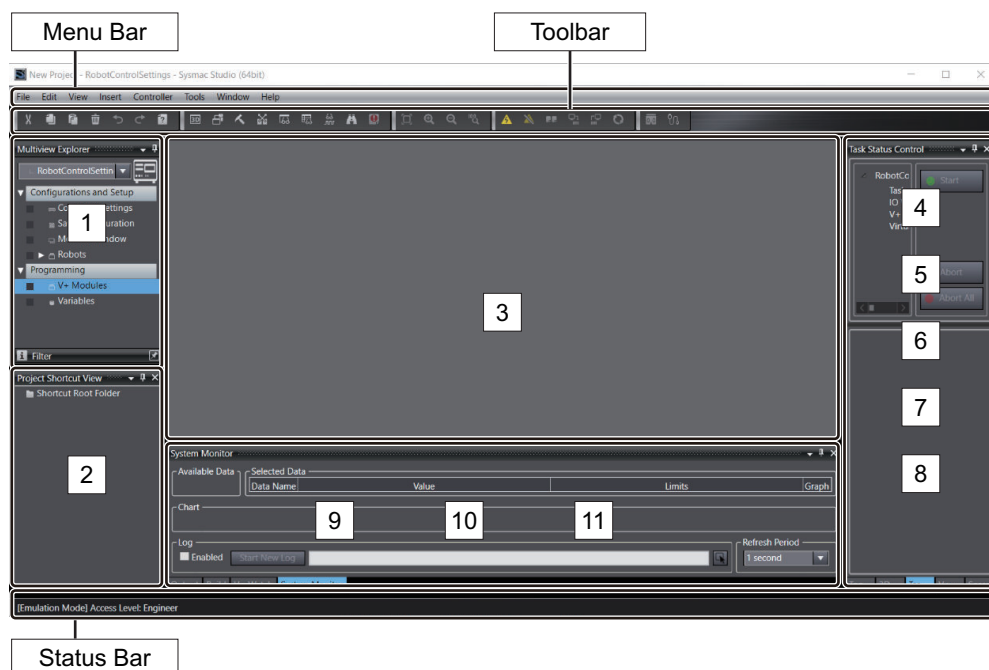

Number	Name
1	Multiview Explorer
2	Project Shortcut View
3	Edit Pane
4	Toolbar
5	Search and Replace Pane
6	Task Status Control Pane
7	3D Visualizer
8	V+ Jog Control Pane
9	Build Tab Page
10	V+ Watch Tab Page
11	System Monitor Pane

### Menu Bar, Toolbar, and Status Bar

Hiding/Showing the Menu Bar, Toolbar, and Status Bar are common in the Sysmac Studio. Refer to the *Sysmac Studio Version 1 Operation Manual (Cat. No. W504)* for details.

### Status Bar Display Information

When using the Robot Integrated CPU Unit, the following information is displayed in the status bar.

**[Emulation Mode] Access Level: Engineer**

When opening the project, the on/off status of the emulation mode selected in **Robot System** is displayed.

It also displays the access level set by the robot system operation authority verification function and authenticated by sign-in.

Refer to *8-2 Robot System Operation Authority Verification* on page 8-8 for the robot system operation authority verification function and sign-in.

#### 4-3-2 Project Shortcut View

You can create shortcuts for items, which are displayed under Configurations and Setup and Programming in the Multiview Explorer, to access them easier.

#### 4-3-3 Edit Pane

The Edit Pane displays detailed data of Configurations and Setup items and the V+ Program Editor window.

#### 4-3-4 Toolbox

The Toolbox shows the objects that you can use to edit the data that is displayed in the Edit Pane.

#### 4-3-5 Search and Replace Pane

In the Search and Replace Pane, you can search for and replace any string of the V+ programs under Programming in the Multiview Explorer.

#### 4-3-6 Task Status Control Pane

The Task Status Control Pane is the control screen for robot control. Refer to *7-4 Task Status Control* on page 7-28 for details.

#### 4-3-7 3D Visualizer

The 3D Visualizer shows robots, conveyors, and other equipment to check operations in the 3D simulation. Refer to *7-2 3D Visualizer* on page 7-4 for details.

### 4-3-8 V+ Jog Control Pane

The V+ Jog Control Pane is for robot jog operations. Refer to 7-3 *V+ Jog Control* on page 7-20 for details.

### 4-3-9 Build Tab Page

The Build Tab Page shows results of V+ program checks.

### 4-3-10 V+ Watch Tab Page

The V+ Watch tab page shows results of monitoring V+ variables. Refer to 7-9-1 *Variable Monitoring* on page 7-61 for details.

### 4-3-11 System Monitor Pane

The System Monitor pane displays robot parameters graphically in real time and output them to a log file.

Refer to 7-9-3 *System Monitor* on page 7-62 for details.

## 4-4 Using Online and Offline Modes of the Sysmac Studio

---

Projects for a Robot Integrated System (Robot Integrated CPU Unit) support *Emulation Mode* that allows the emulator of the Robot Control Function Module to run. In *Emulation Mode*, you can set up the Robot Control Function Module, edit V+ Programs, and perform offline debugging.

Data that you can edit or functions that you can use differ depending on the combination of this *mode* and the connection status, i.e., *Simulator connection* or *online connection with the physical Controller*.

The following figure shows the state transition of the connection status, which starts from the start page.



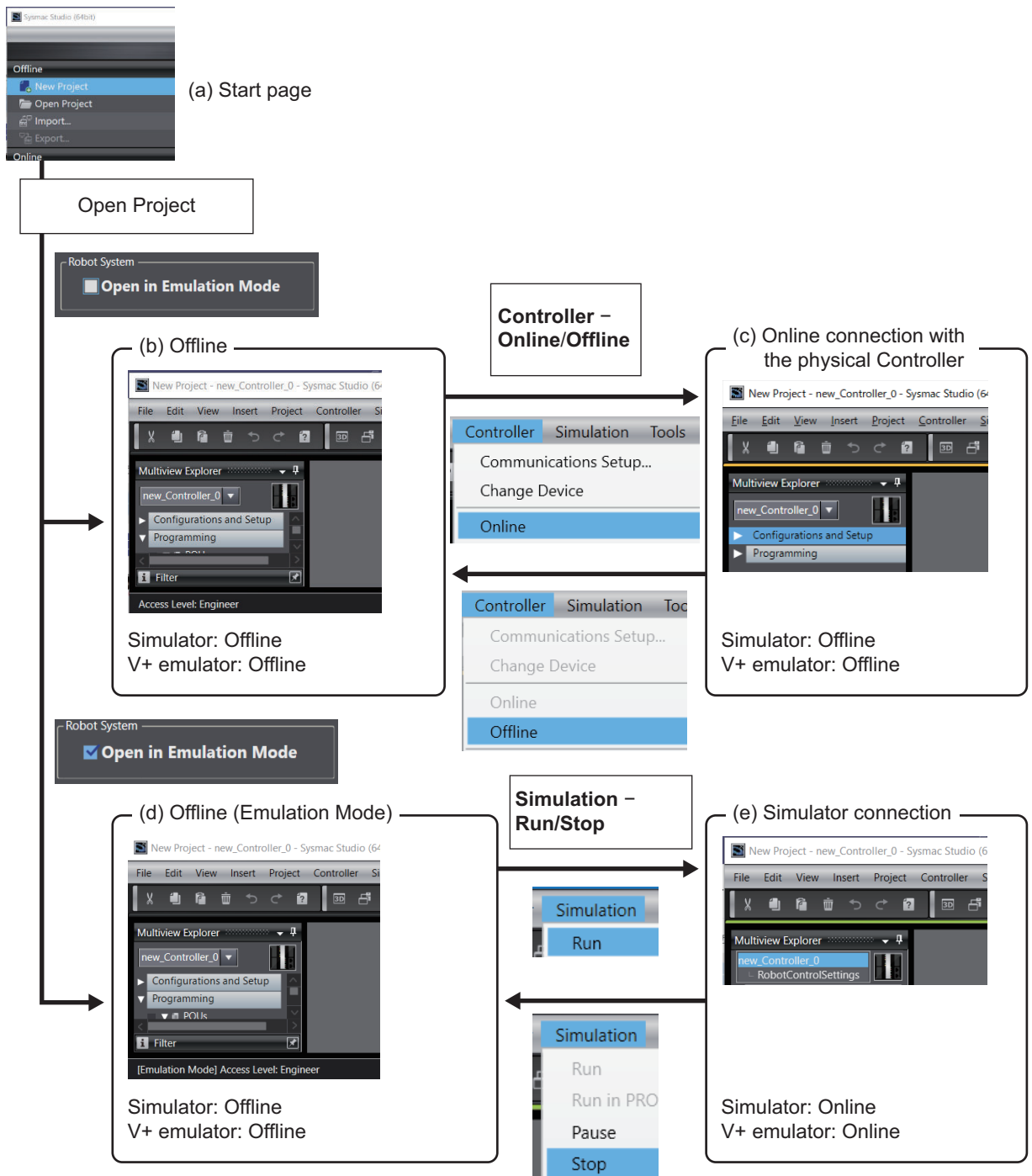

The following table shows the operation and application that can be used in each status.

	Status	Application	Data that can be edited, or operation that can be performed	Data that cannot be edited	State transition destination	State transition operation
(a)	Start page (Before the project is opened)	Project selection	Selecting the project and choosing whether to open the project in Emulation Mode	Project data	Offline	Open the project with <b>Open in Emulation Mode</b> check box cleared.
					Offline (Emulation Mode)	Open the project with <b>Open in Emulation Mode</b> check box selected.
(b)	Offline	Controller configuration and setup, programming Editing of V+ Programs and V+ Variables	Controller configuration and setup, programming (programs, variables, data types, V+ Programs, V+ Variables)	Items that cannot be edited among Robot Settings	Online connection with the physical Controller	Select <b>Online</b> from the <b>Controller</b> menu, or click the Online button.
(c)	Online connection with the physical Controller	Debugging, adjustment, and maintenance of the physical Controller	<ul style="list-style-type: none"> <li>Controller programs, variables (with online editing)</li> <li>V+ Programs, V+ Variables, Robot Settings (in V+ Edit Mode)</li> </ul>	Controller configuration and setup, data types	Offline	Select Offline from the <b>Controller</b> menu, or click the <b>Offline</b> button.
(d)	Offline (Emulation Mode)	Controller configuration and setup, programming Editing of V+ Programs and V+ Variables	Controller configuration and setup, programming (programs, variables, data types, V+ Programs, V+ Variables)	Items that cannot be edited among Robot Settings	Simulator connection	Select <b>Run</b> from the <b>Simulation</b> menu.
(e)	Simulator connection	Debugging with Controller simulation Robot Settings, offline teaching, Offline debugging of V+ Programs	<ul style="list-style-type: none"> <li>Controller programs, variables (with online editing)</li> <li>V+ Programs, V+ Variables, Robot Settings</li> </ul>	Controller configuration and setup, data types	Offline (Emulation Mode)	Select <b>Stop</b> from the <b>Simulation</b> menu.



#### Additional Information

- A Robot Integrated Systems project allows Simulator connection in Emulation mode only.
- You can change between (b) *Offline* and (d) *Offline (Emulation Mode)* statuses by selecting **Enable emulation mode** or **Disable emulation mode** from the **Controller** menu. This causes the project to once close and then open again.

# 5

## Configurations and Settings of the Controller

This section describes the configurations and settings of devices required for a robot control system including the Robot Integrated CPU Units.

<b>5-1</b>	<b>Configurations and Settings of the Controller .....</b>	<b>5-2</b>
<b>5-2</b>	<b>EtherCAT Settings.....</b>	<b>5-3</b>
<b>5-3</b>	<b>I/O Settings .....</b>	<b>5-4</b>
5-3-1	How to Assign V+ Digital I/O .....	5-4
5-3-2	V+ Digital I/O Settings .....	5-4
<b>5-4</b>	<b>Robot Integrated CPU Unit Settings.....</b>	<b>5-6</b>
5-4-1	Robot Common Settings .....	5-6
5-4-2	Robot Settings.....	5-8
<b>5-5</b>	<b>Robot Subdevice Settings.....</b>	<b>5-9</b>
5-5-1	Controller Settings.....	5-9
5-5-2	Save Configuration.....	5-21
5-5-3	Monitor Window.....	5-22
<b>5-6</b>	<b>Robot Settings.....</b>	<b>5-24</b>
5-6-1	Robot Settings Tab Page.....	5-24
5-6-2	How to Display Robot Settings Tab Page.....	5-27
5-6-3	Configure.....	5-27
5-6-4	IO EndEffectors .....	5-32

# 5-1 Configurations and Settings of the Controller

Sequence control programs and V+ programs in the Robot Integrated CPU Unit work together to control robots. You will learn setting functions necessary for robot control with sequence control programs and V+ programs. Also, you can learn how to use them.

Refer to *NJ-series Robot Integrated CPU Unit User's Manual (O037)* for details of robot control.

Setting Items	Outline	Reference
Controller Settings	You can configure settings of the Robot Integrated CPU Unit (operation settings, built-in EtherNet/IP settings).	<i>Sysmac Studio Version 1 Operation Manual (Cat. No. W504)</i>
EtherCAT Settings	You can add EtherCAT slaves including Omron robots to the EtherCAT network and configure them.	5-2 <i>EtherCAT Settings</i> on page 5-3
Robot Integrated CPU Unit Settings	You can set robot numbers of Omron robots and robot names used in user programs. Also, you can configure settings to control I/O with V+ programs.	5-3 <i>I/O Settings</i> on page 5-4 5-4 <i>Robot Integrated CPU Unit Settings</i> on page 5-6
Robot Subdevice Settings	You can configure settings for Robot Control Function Modules. Configure the Controller Settings and the Save Configuration.	5-5 <i>Robot Subdevice Settings</i> on page 5-9
Robot Settings	Configure settings for Omron robots. You can set optional settings for each axis, parameters, and obstructions	5-6 <i>Robot Settings</i> on page 5-24

## 5-2 EtherCAT Settings

Configure settings for the registered robot in the EtherCAT Tab Page.

Refer to *4-2-1 Creating a New Project* on page 4-4 to register a robot. For details on items and settings for EtherCAT Configuration of the robot, refer to user's manuals for each robot.

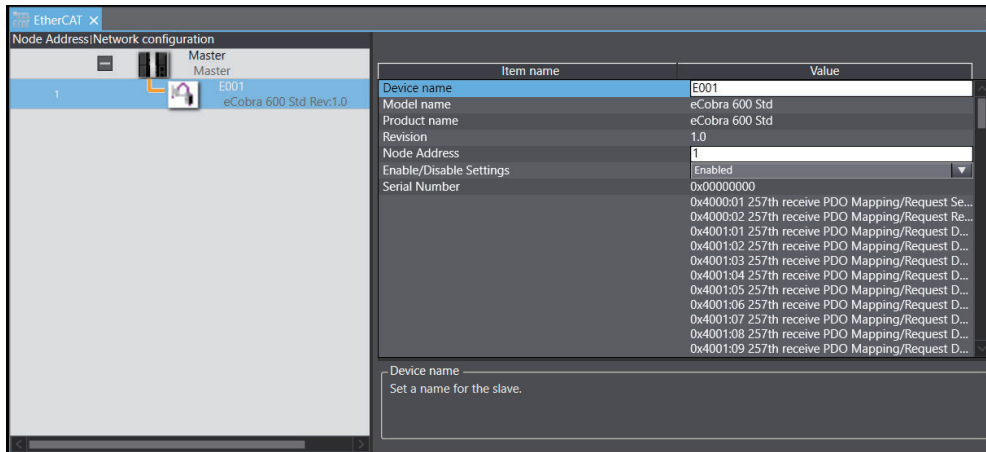

## 5-3 I/O Settings

Configure settings to access I/O of I/O devices through sequence control program and V+ program.

Assign variables to I/O to access I/O of the I/O devices by sequence control program. Register device variables in I/O Map in order to assign variables to device I/O. Refer to *Sysmac Studio Version 1 Operation Manual (Cat. No. W504)* for generation and registration of device variables.

In V+ program, V+ Digital I/O numbers are used to access the I/O of IO devices. Assign V+ Digital I/O to an I/O port of an IO device using the I/O Map.

### 5-3-1 How to Assign V+ Digital I/O

You can assign V+ Digital I/O in either of setting tab pages;

- I/O Map
- V+Digital I/O Settings in Robot Common Settings

Refer to 5-3-2 V+ Digital I/O Settings on page 5-4 for the setting procedure in V+Digital I/O Settings in Robot Common Settings.

Operation procedure to assign V+ Digital I/O numbers in I/O Map is shown below.

- 1 Double-click **I/O Map** from **Configurations and Setup** in Multiview Explorer. I/O Map is displayed.
- 2 Enter V+ Digital numbers for the ports where I/O devices' V+ Digital I/Os can be assigned.

Position	Port	Description	R/W	Data Type	Variable	Variable Comment	Variable Type	V+ Digital I/O
	▼ EtherCAT Network Configuration							
Node2	▼ GX-ID1621+OD08							
	▼ Write output 1st word	Digital output values (2byte)	W	WORD	E001_Write_output		Global Variables	
	Out Bit00	The digital output value of output point of contact 00	W	BOOL	E001_Out_Bit00		Global Variables	
	Out Bit01	The digital output value of output point of contact 01	W	BOOL	E001_Out_Bit01		Global Variables	
	Out Bit02	The digital output value of output point of contact 02	W	BOOL	E001_Out_Bit02		Global Variables	
	Out Bit03	The digital output value of output point of contact 03	W	BOOL	E001_Out_Bit03		Global Variables	
	Out Bit04	The digital output value of output point of contact 04	W	BOOL	E001_Out_Bit04		Global Variables	
	Out Bit05	The digital output value of output point of contact 05	W	BOOL	E001_Out_Bit05		Global Variables	
	Out Bit06	The digital output value of output point of contact 06	W	BOOL	E001_Out_Bit06		Global Variables	
	Out Bit07	The digital output value of output point of contact 07	W	BOOL	E001_Out_Bit07		Global Variables	
	▼ Read input 1st word	Digital input values (2byte)	R	WORD	E001_Read_input		Global Variables	
	In Bit00	The digital input value of input point of contact 00	R	BOOL	E001_In_Bit00		Global Variables	
	In Bit01	The digital input value of input point of contact 01	R	BOOL	E001_In_Bit01		Global Variables	H001
	In Bit02	The digital input value of input point of contact 02	R	BOOL	E001_In_Bit02		Global Variables	H002
	In Bit03	The digital input value of input point of contact 03	R	BOOL	E001_In_Bit03		Global Variables	

Refer to *NJ-series Robot Integrated CPU Unit User's Manual (Cat. No. O037)* for details of V+ Digital I/O number in V+ programs.

### 5-3-2 V+ Digital I/O Settings

Configure V+ Digital I/O settings. This configuration is required when you use I/O signals of digital I/O units or NX-I/O Units registered in an EtherCAT Configuration in V+ program.

Operation procedure is as follows.

- 1 Double-click **Configurations and Setup – Robot Control Setup – Robot Common Settings** in Multiview Explorer. Or, right-click and select **Edit** from the menu. **Robot Common Settings** Tab Page is displayed.

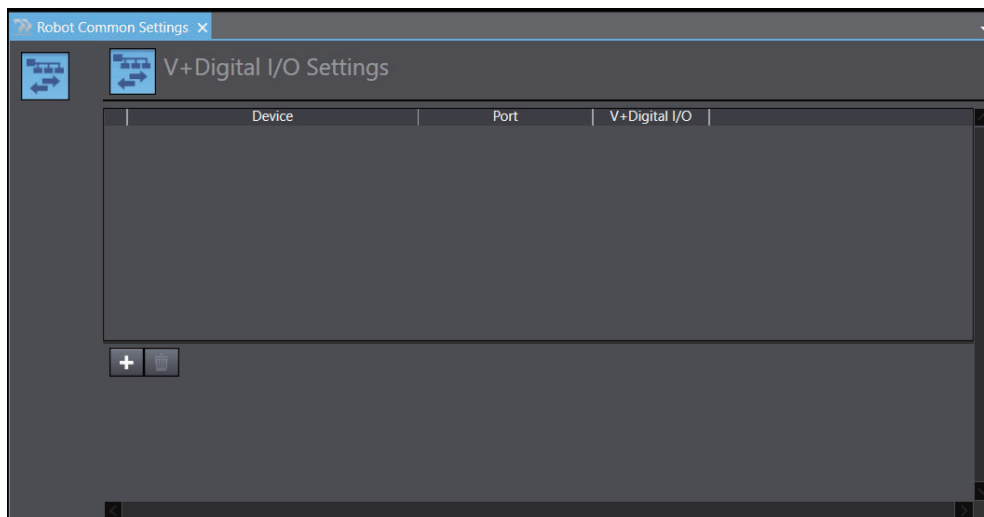

- 2 Click the + button to add assignment settings.

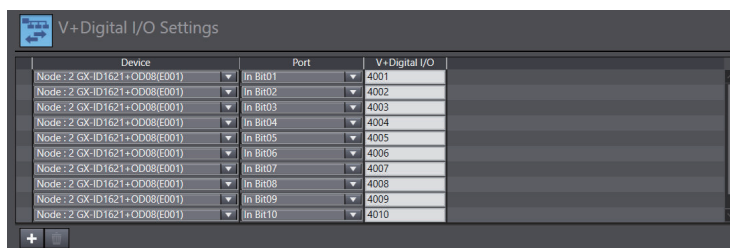

Setting Items	Description	Setting range
Devices	Select devices to which you want to assign V+ Digital I/O from the following slaves registered in the EtherCAT Configuration. <ul style="list-style-type: none"> <li>Digital I/O Unit</li> <li>NX-I/O Unit</li> </ul>	---
Port	Select ports to which you want to assign V+ Digital I/O.	---
V+ Digital I/O	Enter signal numbers to be used in V+ program.	4001-4999

## 5-4 Robot Integrated CPU Unit Settings

Configure settings regarding to the control of the robot registered in the EtherCAT Configuration. Robot control settings include the following.

Target module	Settings	Description
Sequence control module	Robot Common Settings	Settings common in robots, such as V+Digital I/O Settings
	Robot Settings	Basic settings for each robot: e.g. Robot Device Assignment

### 5-4-1 Robot Common Settings

Configure settings common in robots registered in the EtherCAT configuration of the Robot Integrated CPU Unit.

The setting items are as follows.

- V+ Digital I/O Settings
- Remote Encoder Latch Settings

Refer to *NJ-series Robot Integrated CPU Unit User's Manual (Cat. No. O037)* for details.

### Start Robot Common Settings Tab Page

- 1 Double-click **Configurations and Setup – Robot Control Setup – Robot Common Settings** in Multiview Explorer. Or, right-click and select **Edit**.  
**V+ Digital I/O Settings Tab Page** of **Robot Common Settings** is displayed in the Edit Pane.

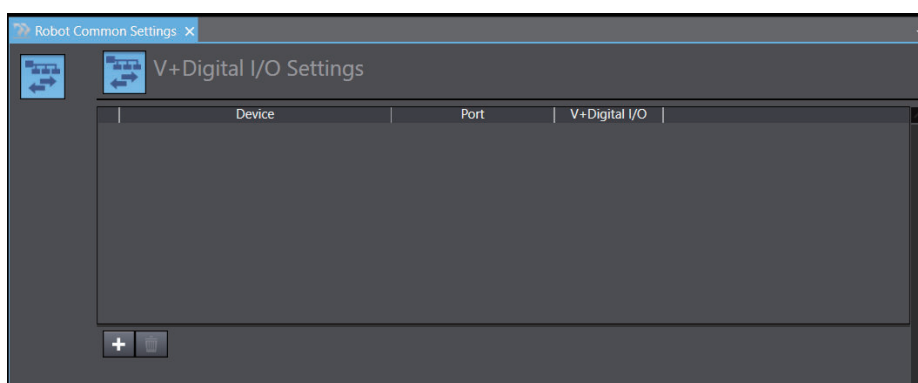

Refer to 5-3-2 *V+ Digital I/O Settings* on page 5-4 for usage of **V+ Digital I/O Settings**.



## Remote Encoder Latch Settings

These settings allow to refer motion control axes of the Robot Integrated CPU Unit from a V+ program as external encoders for robot control. A motion control axes and a latch signal number are to be set to an encoder ID.

Refer to *NJ-series Robot Integrated CPU Unit User's Manual (Cat. No. O037)* for details about how to use the remote encoder latch function and setting items.

Setting procedure is as follows.

- 1 Click the **Remote Encoder Latch Settings** button in the **Robot Common Settings** tab page.

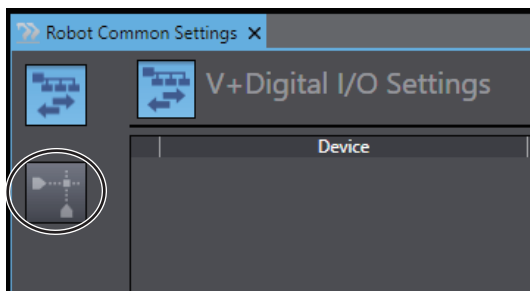

The **Remote Encoder Latch Settings** tab page is displayed.

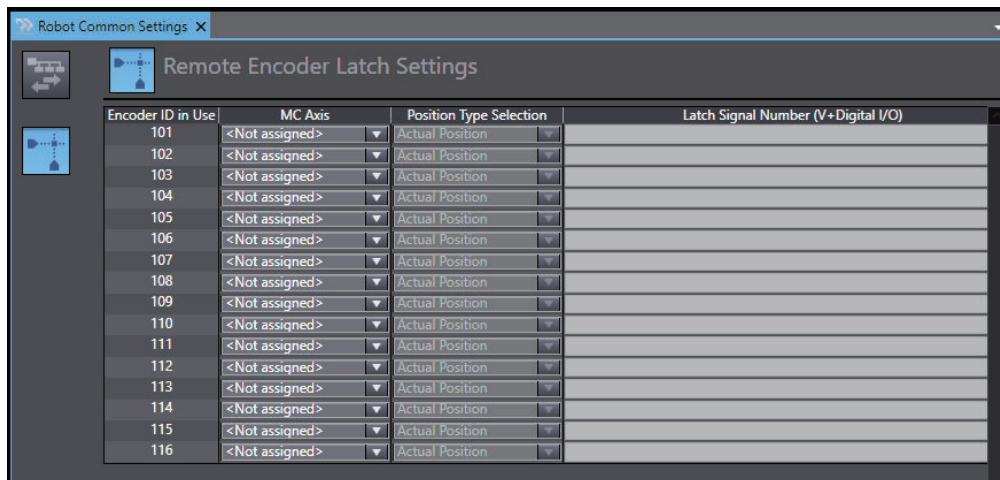

Setting Item	Description	Setting range
Encoder ID in Use	Encoder ID used to reference motion control axes from the V+ program.	101 to 116 (Not editable)
MC Axis	Select the motion control axis number referenced as a remote encoder.	Not assigned/ Axis number
Position Type Selection	Select the position of the referenced motion control axis.	Feedback position/ Command position
Latch Signal Number (V+ digital I/O)	Set latch signal numbers and latch trigger conditions to get latch results of the remote encoders from the V+ program. A V+ digital I/O number set in the <b>V+ Digital I/O Settings</b> is specified for a latch signal number.	±4001 to 4999 +: Latches a signal at the rise of the signal -: Latches a signal at the falling of the signal

- 2 Select a motion control axis you want to reference as a remote encoder to configure each item.

## 5-4-2 Robot Settings

Configure settings common in robots registered in the EtherCAT configuration of the Robot Integrated CPU Unit.

Refer to *NJ-series Robot Integrated CPU Unit User's Manual (Cat. No. O037)* for details.

### Start Robot Settings Tab Page

- 1 Double-click **Configurations and Setup – Robot Control Setup – Robot Settings** in Multi-view Explorer. Or, right-click and select **Edit** from the menu. Double-click RC\_Robot001, for example.

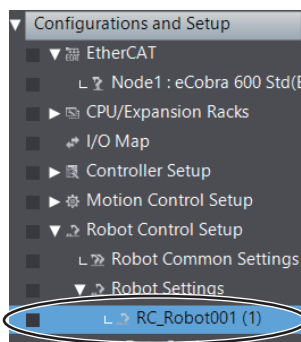

**Robot Basic Settings** Tab Page is displayed in the Edit Pane.

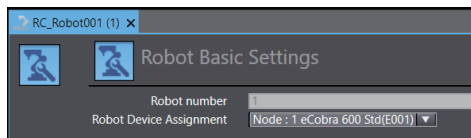

Setting Items	Description
Robot number	Number to identify a robot. The number is automatically given when a robot is registered to EtherCAT Configuration or a new robot setting is added to <b>Robot Control Setup</b> in Multiview Explorer.
Robot Device Assignment	You can select an EtherCAT robot to assign.



#### Additional Information

A robot setting will be automatically added after a robot is registered to EtherCAT Configuration. Or you can add the new setting by a right-click on **Robot Settings** in Multiview Explorer.

## 5-5 Robot Subdevice Settings

Configure Robot Control Function Modules of the Robot Integrated CPU Unit.

Select the subdevice *RobotControlSettings* from a project's device list to configure Robot Control Function Modules.

Target module	Settings	Description
Robot Control Function Module	Controller Settings	You can configure settings for Robot Control Function Modules. Set IP addresses and other attributes to connect with robot control modules of the Robot Integrated CPU Unit.
	Save Configuration	Settings regarding V+ programs, variables, and belt calibration that run at power on.
	Monitor Window	You can directly enter V+ monitor commands for a Robot Control Function Module into this window through the keyboard to control the robot.
	Robot	Registered robots are displayed.

You must connect the Simulator to the Robot Integrated CPU Unit in the *EMULATION mode* or configure Robot Control Function Modules.

Refer to 7-6 *How to Start Simulation* on page 7-41 for the procedure to connect the Simulator.

As for the procedure of online connection with the Robot Integrated CPU Unit, see 8-1-2 *Connection to the Robot Integrated CPU Unit* on page 8-2.



### Precautions for Correct Use

Changes of setting items for a robot control module are fed back to the robot control module in real time. Give your attention to the robot's behaviors when you change settings staying online to the Robot Integrated CPU Unit.

### 5-5-1 Controller Settings

You can configure settings for Robot Control Function Modules. Set IP addresses and other attributes to connect with robot control modules of the Robot Integrated CPU Unit.

#### How to Display the Tab Page

- 1 Double-click **Configurations and Setup – Controller Settings** in Multiview Explorer. Or, right-click and select **Edit** from the menu.

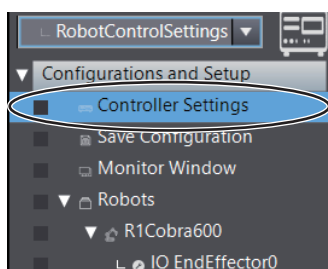

The **Controller Settings** Tab Page is displayed.

## Controller Settings Tab Page

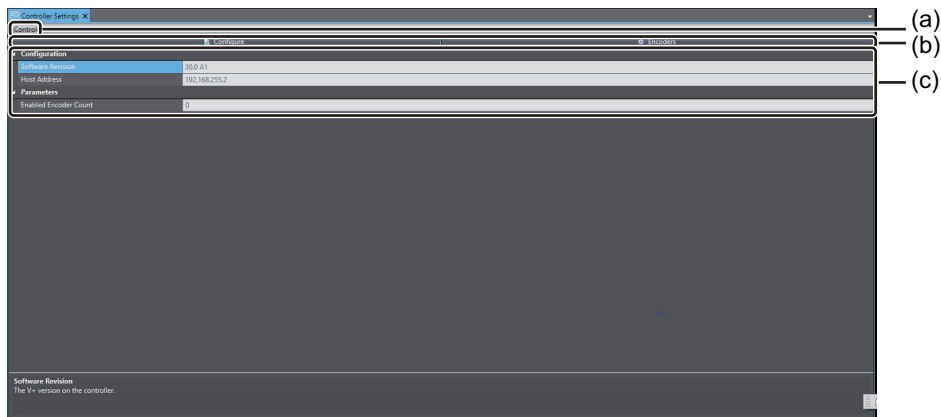

	Category	Setting Item	Description	Reference
(a)	Control menu	Reboot V+	Not available	---
		Servo Reset	Reset connected robots' servos.	<i>Servo Reset</i> on page 5-10
		V+ Zero Memory	Not available	---
		Save Startup Specifications	Specifications data of all robots are saved in order to be used at a startup. Also selectable from <b>Settings</b> menus of each robot's setting tab pages.	<i>Save Startup Specifications</i> on page 5-11
		Save Memory to File	Save all V+ programs to the PC. A Save File Dialog Box is displayed.	<i>Save Memory to File</i> on page 5-11
		View eV+ Log	Display the information about V+ logs.	<i>View eV+ Log</i> on page 5-11
(b)	---	Settings	Configure encoder latch, robot position latch, and system settings.	<i>Settings</i> on page 5-12
		Encoder	Start encoders to check position or velocity.	<i>Encoders</i> on page 5-20
(c)	Configura-tion	Software Revision	Show versions of Robot Control Function Modules. It is displayed only when the Sysmac Studio goes Online with the Robot Integrated CPU Unit.	---
		Host Address	Display IP address of the Robot Integrated CPU Unit.	---
	Parameters	Enabled Encoder Count	Display the number of external encoders used in the system. Displayed number is related with the number of channels of belt encoders set in the system.	<i>Configure Belt Encoder Latches</i> on page 5-13

## Control Menu

Operation procedures for menus are described below.

### ● Servo Reset

Reset robots' servo motors.

- 1 Select **Servo Reset** from **Control** menu.

Robots' servo motors are reset.

### ● Save Startup Specifications

Configuration data of all robots are saved in order to be used at a startup of the Robot Integrated CPU Unit.

- 1 Select **Save Startup Specifications** from **Control** menu.  
Current settings of *RobotControlSettings* are saved to be loaded when the Robot Integrated CPU Unit starts up.

### ● Save Memory to File

Save all V+ programs to the PC.

- 1 Select **Save Memory to File** from **Control** menu.  
The **Save** dialog box is displayed.

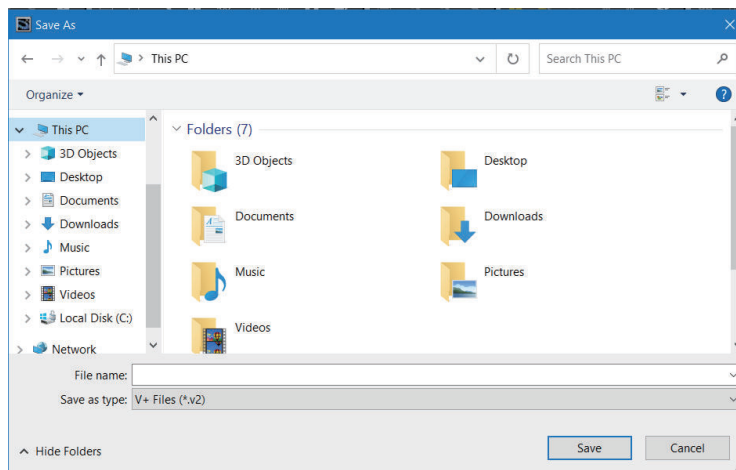

- 2 Specify the destination and file name, then click the **OK** button.  
All V+ programs of *RobotControlSettings* are saved.

### ● View eV+ Log

Display the information about V+ logs.

- 1 Select **eV+ Log** from the **Control** menu.  
**eV+ Log** dialog box is displayed.

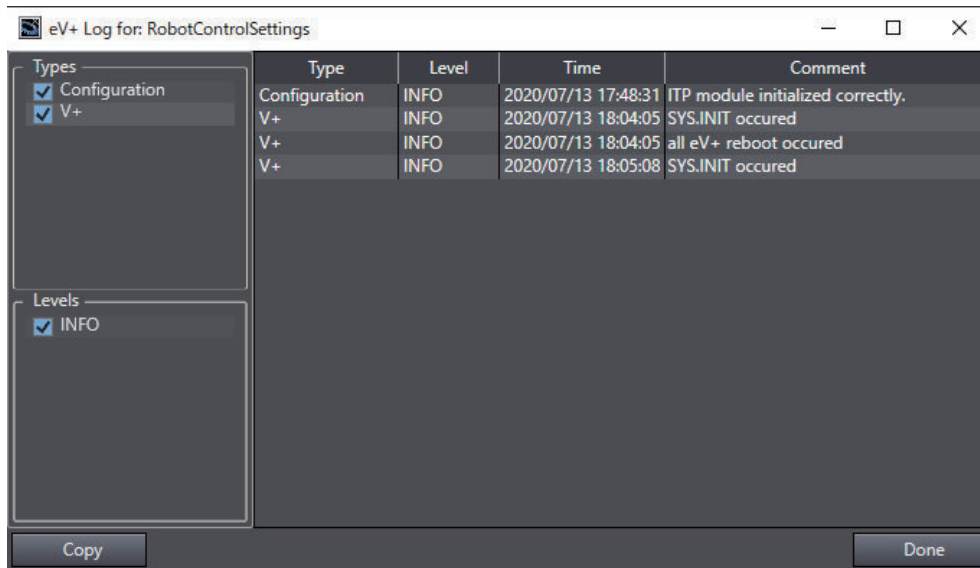

Event history of Robot Control Function Modules since the Robot Integrated CPU Unit starts up is shown in the **eV+ Log** dialog.

Events of items that **Type** and **Level** boxes are checked are listed.

Click the **Copy** button to copy all events in the list to the clip board.

## Settings

Configure encoder latch, robot position latch, and system parameter settings.

Item	Description	Reference
Configure Belt Encoder Latches	Set latch signals for the Controller's each encoder channel.	<i>Configure Belt Encoder Latches</i> on page 5-13
Configure Robot Position Latches	Set latch signals to acquire robot position.	<i>Configure Robot Position Latches</i> on page 5-15
Configure Robots Safety Timeout	Set effective time for the Robot High Power button.	<i>Configure Robots Safety Timeout</i> on page 5-17
Configure System Settings	Configure system parameters for Robot Control Function Modules.	<i>Configure System Settings</i> on page 5-18

Operation procedure is as follows.

- 1 Click the **Configure** button in the **Controller Settings** Tab Page.

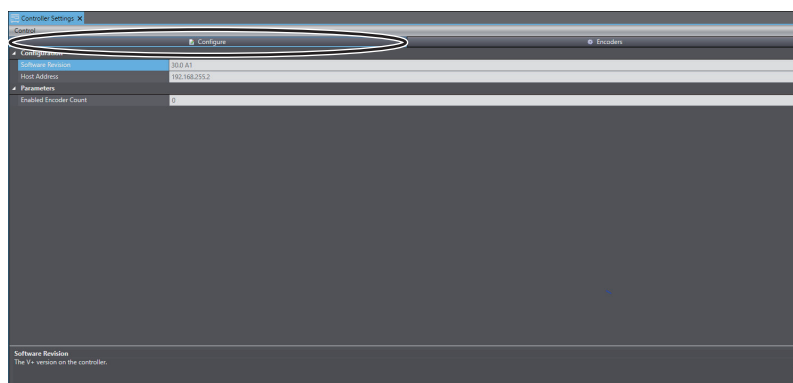

**Configure Options** dialog box is displayed.

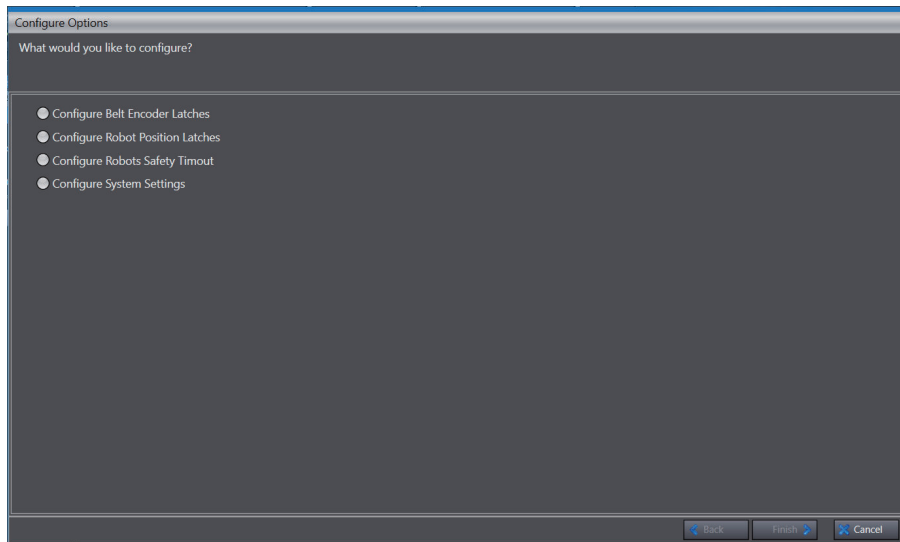

- 2** Check a radio button of the target setting, then press the **Finish** button.  
The setting tab page for the selected setting is shown.

### ● **Configure Belt Encoder Latches**

Set latch signals for the Controller's each encoder channel.

Belt Encoder Latch acquires position values of conveyor belt's encoders when input signal changes its state. You can check the current position and velocity of encoders of each encoder channel.

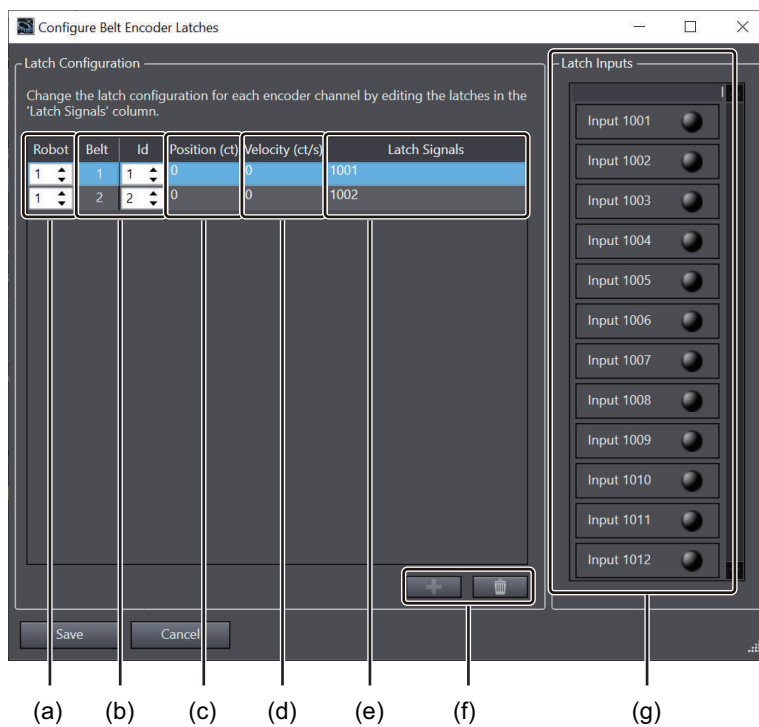

	Item	Description
(a)	Robot	The number of the robot connected to the Robot Integrated CPU Unit

	Item	Description
(b)	Belt	The number of the local encoder connected to the robot
	Id	The unique number assigned to the local encoder
(c)	Position (cts)	Indicate the current position of the belt encoder by the value of the encoder pulse (cts).
(d)	Velocity (ct/sec)	Indicate the current velocity of the belt encoder by the value of the encoder pulse (ct/sec).
(e)	Latch Signal	<p>Show the latch signal assignment for the belt encoder. You can set multiple latch signals as follows:</p> <ul style="list-style-type: none"> <li>Designate a falling state by minus sign  <i>1001</i>: Position data of encoder channel is latched when the signal 1001 switches from OFF to ON  <i>-1001</i>: Position data of encoder channel is latched when the signal 1001 switches from ON to OFF</li> <li>A space is inserted between signals to set multiple signals  <i>1001 1004</i>: Position data of encoder channel is latched when either of the signal 1001 or 1004 switches from OFF to ON  <i>-1001 1003</i>: Position data of encoder channel is latched when the signal 1001 switches from ON to OFF or the signal 1003 switches from OFF to ON.</li> </ul>
(f)	Add/Delete Encoder Channel	You can add or delete an encoder channel by clicking the button.
(g)	Common Latch Inputs	Indicate statuses of available input signals. ON: Solid green OFF: Off

Configure Belt Encoder Latches following the procedure below.

- 1 Select **Configure Belt Encoder Latches** in the **Configure Options** dialog box, then click the **Done** button.  
**Configure Belt Encoder Latches** dialog box is displayed.

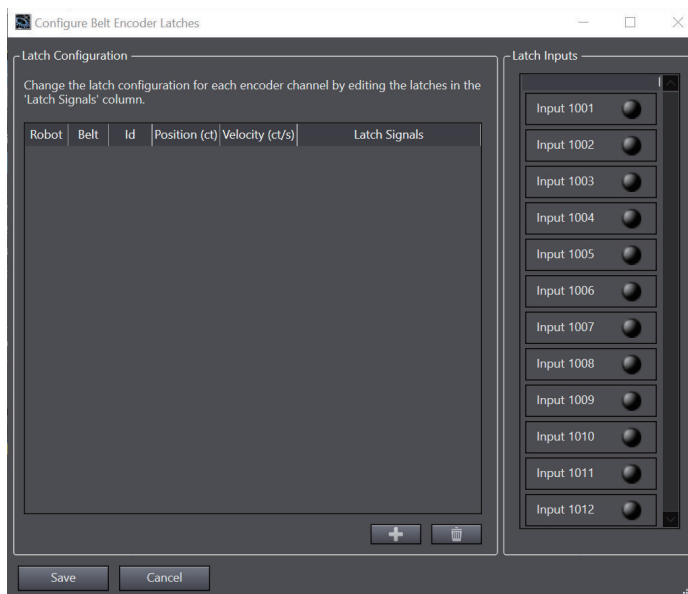



- 2 Add necessary encoder channels, then click the **Save** button. Confirmation dialog box for a reboot of eV+ is displayed.

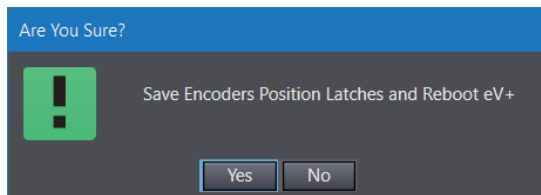

- 3 Click the **Yes** button if you are OK with a reboot of eV+. Configuration of Belt Encoder Latches is saved and eV+ reboots.

### ● Configure Robot Position Latches

Set latch signals to acquire robot position.

Robot Position Latch acquires robot's position at the conveyor belt when input signal (latch) changes its state. Robot position is acquired as precision point. It is a data structure including values for each joint of the robot. After setting up, the robot position latch is mainly used in applications that require high position accuracy guided by the image sensor without stopping the robot's movement.

Select **Configure Robot Position Latches** in the **Configure Options** dialog box, then click the **Done** button. **Configure Robot Position Latches** dialog box is displayed.

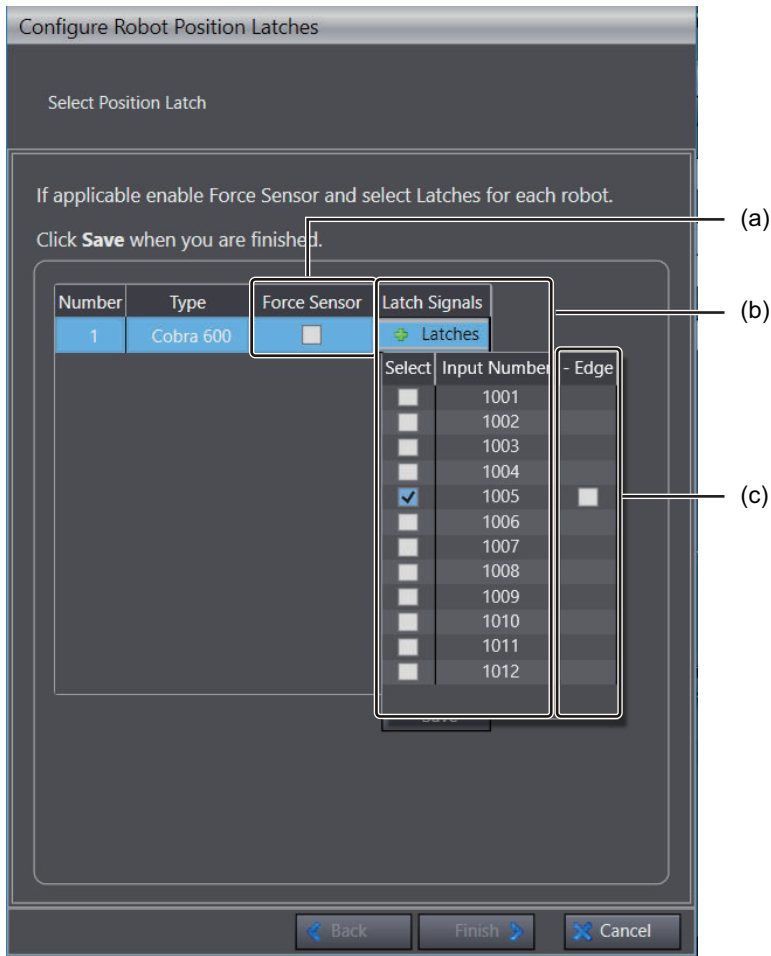

	Item	Description
(a)	Force Sensor	Check the box to enable Force Sensors of each axes of the robot.
(b)	+ Latches button	Click the button to show a input signal list available to trigger the Robot Position Latches. Select input signals from the list.
	Input signal list	List of input signals usable as latch.
(c)	Edge	Check the box to flip a signal. A latch occurs when the checked input signal turns from ON to OFF. If not checked, a latch occurs when an input signal turns from OFF to ON.

Configure Robot Position Latches following the procedure below.

- 1 Select **Configure Robot Position Latches** in the **Configure Options** dialog box, then click the **Done** button.  
**Configure Robot Position Latches** dialog box is displayed.

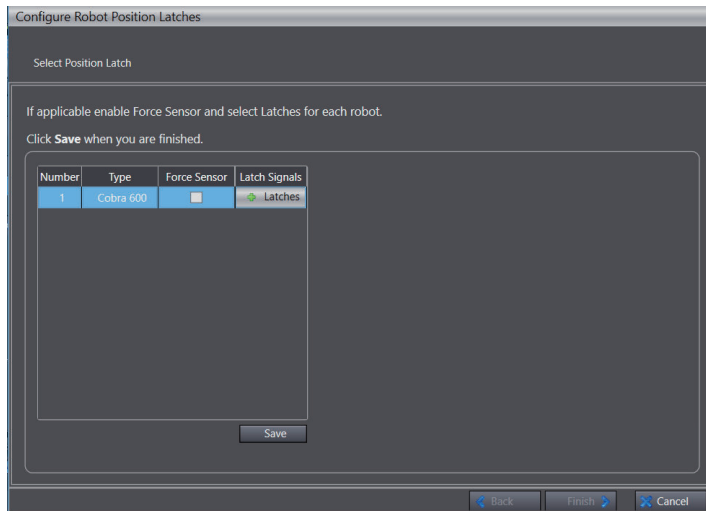

- 2 Check the Force Sensor that uses Robot Position Latch, then click the **+ Latches** button. Input signal list is displayed.

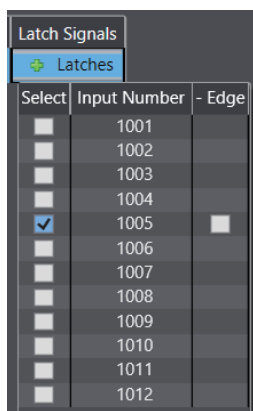

- 3 Check the input number used as latch, then click the **Save** button.
- 4 Click the **Yes** button in the confirmation dialog box. Configuration of Robot Position Latches is saved and eV+ reboots.
- 5 Click the **Finish** button. The **Configure Robot Position Latches** dialog box is closed.

### ● Configure Robots Safety Timeout

Set the effective time between receiving a robot high power request sent from a connected PC, running program, High Power Enable button on the front panel, or optional pendant, and accepting the Robot High Power button. Pressing the Robot High Power button within the time that set for Safety Timeout after receiving a high power request will supply power to the robot.

If Safety Timeout is enabled, a high power request will make the robot's power button on the front panel blink for a set period of time. If the Robot High Power button is not pressed within the specified time, a safety timeout will occur, and no power is supplied to the robot.



### Precautions for Correct Use

When the Robots Safety Timeout is disabled, the power will be supplied to the robot immediately after receiving a high power request. If you disable the Robots Safety Timeout, ensure an adequate safety measure.

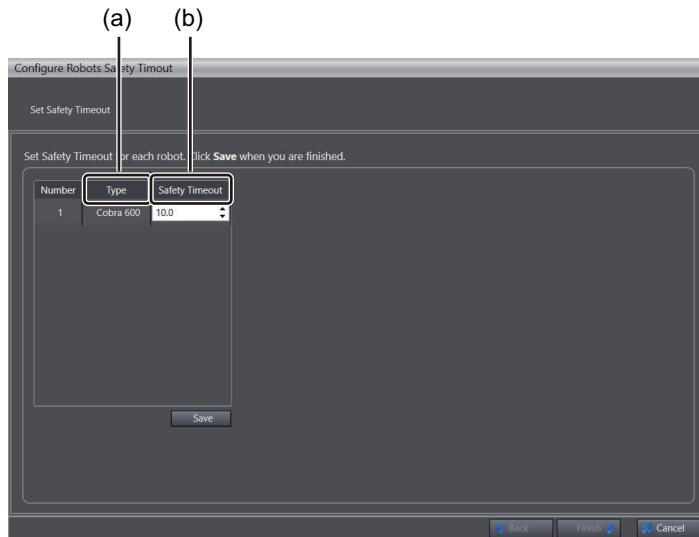

Item	Description
Type	Target robot
Safety Timeout	0 second: Secondary responses to a high power request is disabled and power is immediately provided to the robot. 0.1-60.0 seconds: When the <b>Robot Power</b> button on the front panel is pressed within a set period of time, power is supplied to the robot.

Configure Robot Safety Timeout following the procedure below.

- 1** Select **Configure Robots Safety Timeout** in the **Configure Options** dialog box, then click the **Done** button.  
**Configure Robots Safety Timeout** dialog box is displayed.
- 2** Set the timeout duration, then click the **Save** button.
- 3** Click the **Yes** button in the confirmation dialog box.  
Configuration of Robots Safety Timeout is saved and eV+ reboots.
- 4** Click the **Finish** button. The **Configure Robots Safety Timeout** dialog box is closed.

### ● Configure System Settings

Configure system parameters for Robot Control Function Modules.

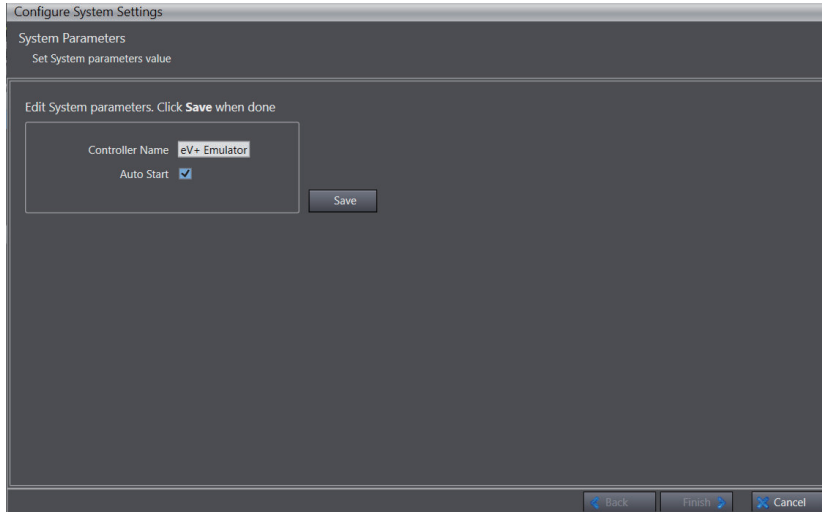

Item	Description	Set value	Initial value
Controller name	Show Robot Control Function Module name.	Any strings	Display eV+ Emulator in the EMULATION MODE.
Auto Start	Enable or disable the Auto Start of V+ programs. If the Auto Start is enabled, upon completion of a startup process, the Robot Integrated CPU Unit will read and execute modules or variable files listed in D:\AUTO.V2, stored in the SD Memory Card inserted to the Robot Integrated CPU Unit. Refer to 5-5-2 Save Configuration on page 5-21 for details.	Checked or unchecked	Unchecked (Disabled)

Configure System Settings following the procedure below.

- 1 Select **Configure System Settings** in the **Configure Options** dialog box, then click the **Done** button.

**Configure System Settings** dialog box is displayed.

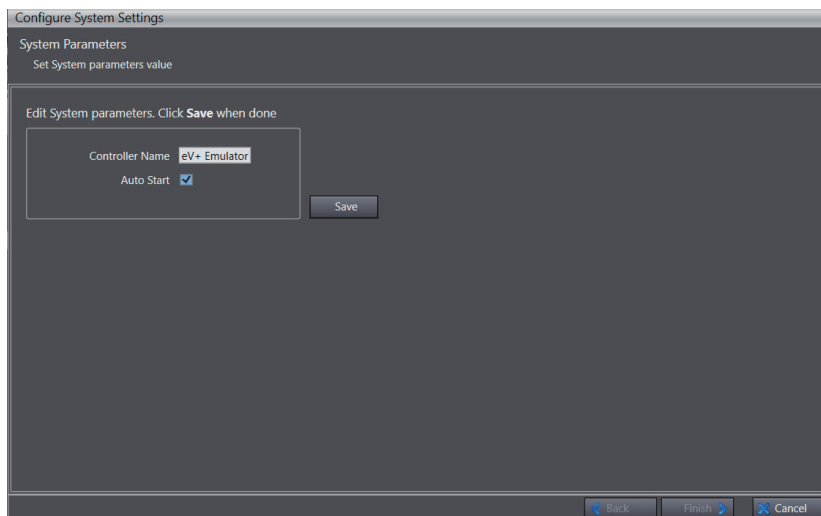

- 2 After configuration, click the **Save** button.

- 3 Click the **Yes** button in the confirmation dialog box.  
Configuration of System Settings is saved and eV+ reboots.
- 4 Click the **Finish** button to close the dialog box.

## Encoders

Statuses of encoders connected with encoder channels of the Robot Integrated CPU Unit are shown.

Encoder Channel	Position (ct)	Velocity (ct/s)	Running
Encoder 0	8979	100	<input checked="" type="checkbox"/>
Encoder 1	8907	100	<input checked="" type="checkbox"/>

Item	Description
Encoder Channel	Display the encoder channels that set in the system. Configure encoder channel settings in Configure Belt Encoder Latches. Refer to <i>Configure Belt Encoder Latches</i> on page 5-13 for details.
Position (cts)*1	Indicate the current position of the encoder by the value of the encoder pulse (cts).
Velocity (ct/sec) *1	Indicate the current velocity of the encoder by pulse (ct/sec).
Running	Check the box to proceed the encoder's count at a specified speed.

\*1. In EMULATION MODE, you can set a value by entering a numeric.

To show the dialog, follow the procedure below.

- 1 Click the **Encoders** button in the **Controller Settings** Tab Page.

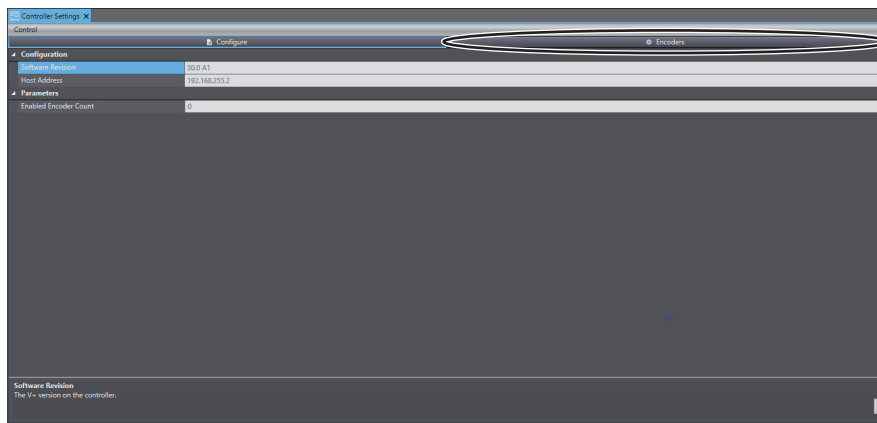

**Encoders** dialog box is displayed.

Encoder Channel	Position (ct)	Velocity (ct/s)	Running
Encoder 0	8979	100	<input checked="" type="checkbox"/>
Encoder 1	8907	100	<input checked="" type="checkbox"/>

- 2 Click the × button to close the dialog box.

## 5-5-2 Save Configuration

Settings regarding V+ programs, variables, and belt calibration that run at power on.

Refer to the *NJ-series Robot Integrated CPU Unit User's Manual (Cat. No. O037)* for details on the data and files that are saved.

### WARNING

If an execution program and task number are specified and the automatic execution of V+ program is enabled, it may possibly happen that the robot operates after the CPU Unit and robot are turned on. Make sure that the movement of the robot does not cause a danger.



## How to Display the Tab Page

- 1 Double-click **Configurations and Setup – Save Configuration** in the Multiview Explorer. The **Save Configuration** Tab Page is displayed.

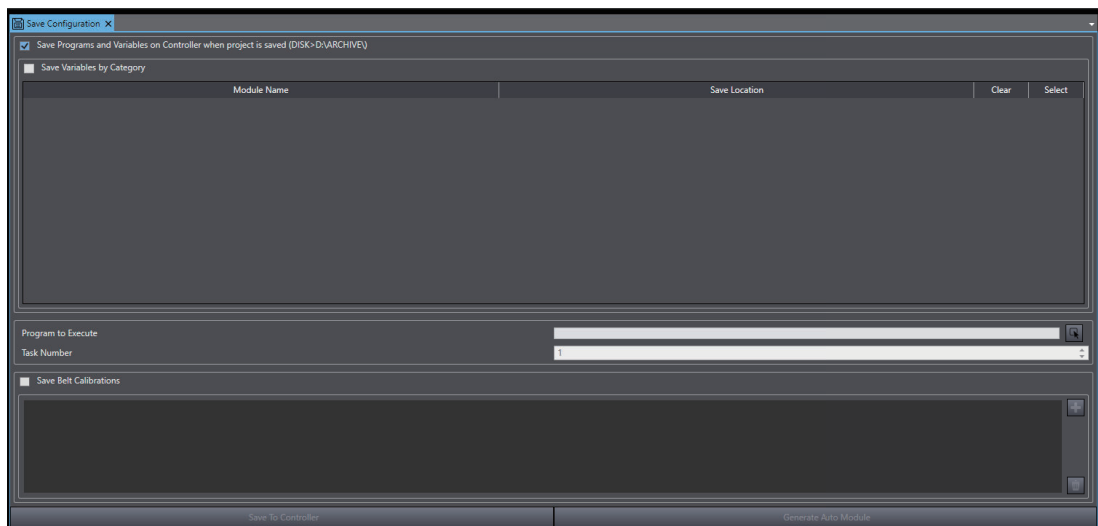

## Save Configuration Tab Page

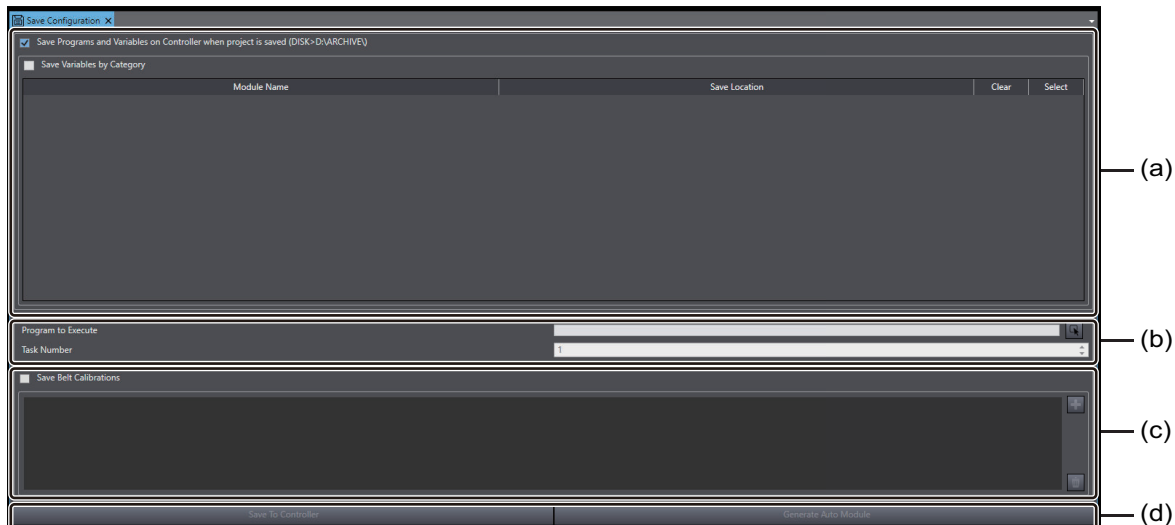

	Setting Items	Description
(a)	Save Programs and Variables on Controller when project is saved (DISK>D:\ARCHIVE\)	Check the box to save V+ programs and variables to the SD Memory Card in the Robot Integrated CPU Unit when a project is downloaded or V+ EDIT mode exits.
	Save Variables by Category	Check the box to save variables by category that set in the variable table. Refer to 6-2-2 <i>Registering V+ Variables</i> on page 6-3 to set categories in the variable table.
(b)	Program to Execute/Task Number	Program and task number that automatically executed are set respectively at the Robot Integrated CPU Unit's power turned on.
(c)	Save Belt Calibrations	Save settings of calibration data if belt calibration data exists. Check the box to add criteria for belt calibration you want to save.
(d)	Save To Controller	Pressing this button saves the settings to the Robot Integrated CPU Unit.
	Generate Auto Module	Pressing this button generates the Auto Modules that run at the Robot Integrated CPU Unit's power turned on, according to settings.



### Precautions for Correct Use

Generated Auto Modules are effective on a physical Robot Integrated CPU Unit. An Auto Module must be tested on the physical system, not on the simulator.

### 5-5-3 Monitor Window

You can directly enter V+ monitor commands for a Robot Control Function Module into this window through the keyboard to control the robot.

## How to Display the Tab Page

- 1 Double-click **Configurations and Setup – Monitor Window** in Multiview Explorer. **Monitor Window** Tab Page is displayed.



## Monitor Window Tab Page

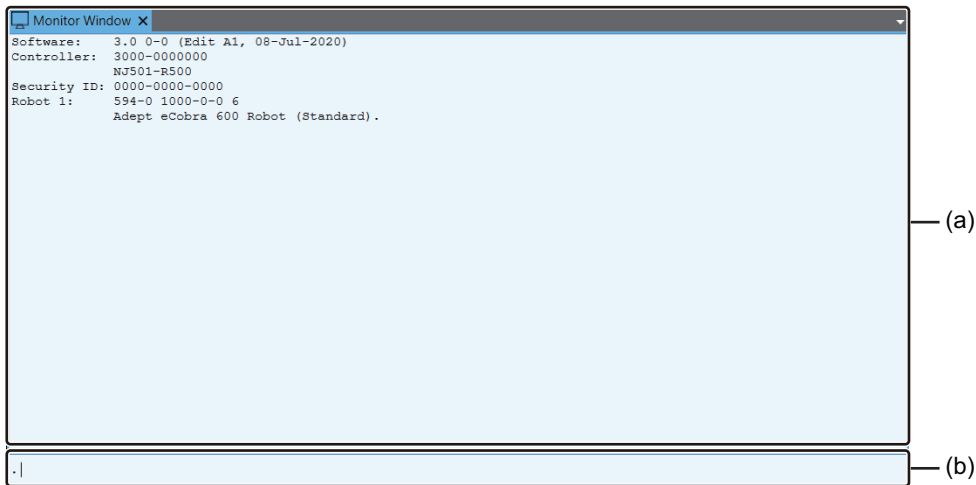

	Item	Description
(a)	Monitor Area	Results of V+ monitor command that entered in Command Input Area are shown.
(b)	Command Input Area	Enter V+ monitor commands. Refer to <i>eV+3 User's Manual (Cat. No. 1651)</i> for details.

## 5-6 Robot Settings

Configure settings for Omron robots.

Select the subdevice *RobotControl/Settings* from a project's device list.

### 5-6-1 Robot Settings Tab Page

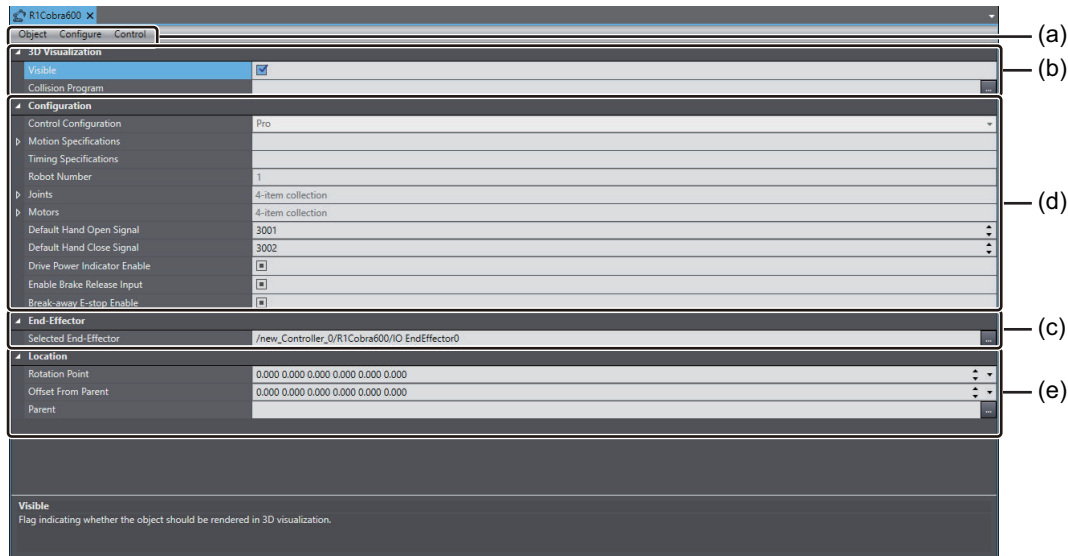

	Category	Setting Items	Description
(a)	Object	Expert Access	Not available. For future expansion.
	Configure	Save Startup Specifications* <sup>1</sup>	Specifications data of a robot is saved in order to be used at a startup.
		Load Spec File	Not available. For future expansion.
		Save Spec File	Not available. For future expansion.
		Axes, Options, and Kinematics* <sup>2</sup>	Dialog box for configuration of enabled axes, option bits that control the presence of special features, and kinematic parameters used in position calculations is displayed.
		Obstacles* <sup>1</sup>	Select Obstacles to add / edit the location, type, and size of workcell obstacles.
		S-Curve Profiles* <sup>1</sup>	Configure the four time values required to create a new s-curve profile used for robot motions.
		Safety Settings* <sup>1</sup>	Use this configuration to restore the factory default settings when the system has delay in the ESTOP hardware or the speed is limited in the Teach mode. Refer to <i>Safety Settings</i> on page 5-30 for details.

	Category	Setting Items	Description
	Control*1	Hardware Diagnostics	Hardware Diagnostics are used to check robot motor status. Refer to <i>10-2 Hardware Diagnostics</i> on page 10-3 for details.
		Data Collection	Data Collection can be used to view, store, and plot various robot system data. Refer to <i>10-3 Data Collection</i> on page 10-5 for details.
		Motor Tuning	Motor Tuning is used to send a square wave positioning command to the specified motor and observe the response for servo motor tuning purposes. Refer to <i>10-4 Motor Tuning</i> on page 10-7 for details.
(b)	3D Visualization	Visible	Check this box to display a robot on the 3D Visualizer.
		Collision Program	You can select C# program which called out when the 3D Visualizer detects a collision of two objects. Click the <b>Selection</b> button at the right to select a program.
(c)	End-Effector	Selected End-Effector	You can select an end-effector to mount to a robot
(d)	Configuration	Timing Specifications*2	Not available. For future expansion.
		Motion Specifications*2	The Motion Specifications item can be expanded to display several settings for robot speed and acceleration as described below. *2 Cartesian Rotation Acceleration: Specifies the Cartesian rotation acceleration at ACCEL 100 (deg/sec <sup>2</sup> ). Cartesian Rotation Speed: Specifies the Cartesian rotation speed at SPEED 100 (deg/sec). Cartesian Translation Acceleration: Specifies the Cartesian translation acceleration at ACCEL 100 (mm/sec <sup>2</sup> ). Cartesian Translation Speed: Specifies the Cartesian translation speed at SPEED 100 (mm/sec). Max Percent Acceleration: Specifies the Maximum allowable percent acceleration from an ACCEL command. Max Percent Deceleration: Specifies the Maximum allowable percent deceleration from an ACCEL command. Max Percent Speed: Specifies the Maximum allowable speed from a SPEED command. SCALE.ACCEL Upper Limit: Specifies the Program speed above which accelerations are saturated when SCALE.ACCEL is enabled.
		Control Configuration	License status of the Robot Object is displayed.
		Robot Number	Numbers of robots are shown.
		Joints*2	The Joints item can be expanded to display settings for range of motion limit, full speed limit, and full acceleration limit of each robot joint.

	Category	Setting Items	Description
		Motors <sup>*2</sup>	The Motors item can be expanded to display settings for motor gain and nulling tolerances for each servo motor in the robot. <sup>*2</sup> Motor Gains: Not available. For future expansion. Fine Nulling Tolerance: Specifies the tolerance for the number of servo motor encoder feed-back counts to consider a move complete when a move is made after specifying FINE tolerance. Refer to <i>eV+3 Keyword Reference Manual (Cat. No. 1652)</i> for details. Coarse Nulling Tolerance: Specifies the tolerance for the number of servo motor encoder feed-back counts to consider a move complete when a move is made after specifying COARSE tolerance. Refer to <i>eV+3 Keyword Reference Manual (Cat. No. 1652)</i> for details.
		Default Hand Open Signal <sup>*2</sup>	You can specify outputs to V+ instructions for OPEN, OPENI, CLOSE, and CLOSEI in the Default Hand Open Signal field. Refer to <i>eV+3 Keyword Reference Manual (Cat. No. 1652)</i> for details.
		Default Hand Close Signal <sup>*2</sup>	You can specify outputs to V+ instructions for OPEN, OPENI, CLOSE, and CLOSEI in the Default Hand Close Signal field. Refer to <i>eV+3 Keyword Reference Manual (Cat. No. 1652)</i> for details.
		Drive Power Indicator Enable <sup>*2</sup>	Selecting <b>Drive Power Indicator Enable</b> toggles the signal which indicate robot power enabled or disabled. Set to enabled, an external indicator can indicate the signal when the robot power is on. Refer to an operation manual of the robot. <b>IMPORTANT:</b> The user must mount and connect an appropriate visible indicator compliant with UL 1740. This function must be activated to be compliant with UL 1740 standards.
		Enable Brake Release Input <sup>*2</sup>	Selecting <b>Enable Brake Release Input</b> toggles ON/OFF of the brake release input signal. You can use an external signal to control the brake of the robot.
		Break-away E-stop Enable <sup>*2</sup>	Select <b>Break-away E-stop Enable</b> to shut down the power supply to the robot from the outer link.
(e)	Location	Rotation Point	Set coordinates or orientation of a robot.
		Parent	Set Parent of robot coordinate system.
		Offset From Parent	Set an offset from Parent of robot coordinate system.

\*1. It is displayed only when the Sysmac Studio is online with the Robot Integrated CPU Unit.

\*2. It is displayed when the Sysmac Studio is online with the simulator or with the Robot Integrated CPU Unit that connected to a physical robot.



### Precautions for Correct Use

Some Robot Settings tab page items such as Obstacles, S-Curve Profiles, or other, are available only when Sysmac Studio stays online-connected to the Robot Integrated CPU Unit. The set information is saved to the Robot Integrated CPU Unit, not to the Sysmac Studio project. To copy the Robot Integrated system data, execute the SD Memory Card Backup for making and restoring a backup copy.

## 5-6-2 How to Display Robot Settings Tab Page

- 1 Select **Configurations and Setup – Robot** from Multiview Explorer, then double-click a target robot name. Or, right-click and select **Edit** from the menu. Select *Cobra 600*, for example.

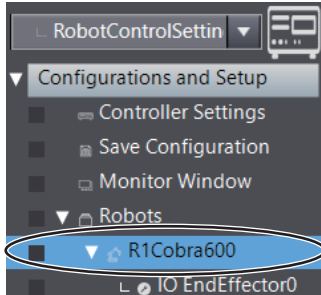

The setting tab page for *Cobra 600* robot is displayed.

## 5-6-3 Configure

Operation procedures for the **Configure** menu are described below.

### Save Startup Specifications

Selecting **Save Startup Specifications** will save all robot and motor specifications to the V+ boot disk.

This is the same function present in the **Controller Settings – Control** menu. Refer to *Control Menu* on page 5-10 for details.

### Axes, Options, and Kinematics

Some robots have enabled axes, option bits that control the presence of special features and kinematic parameters used in position calculations. The **Axes, Options, and Kinematic Parameters** dialog box allows you to edit these parameters.



#### Precautions for Correct Use

Improper editing of robot joints, option bits, and kinematic parameters can cause the robot to malfunction or become inoperable. Therefore, editing must be performed by qualified personnel.

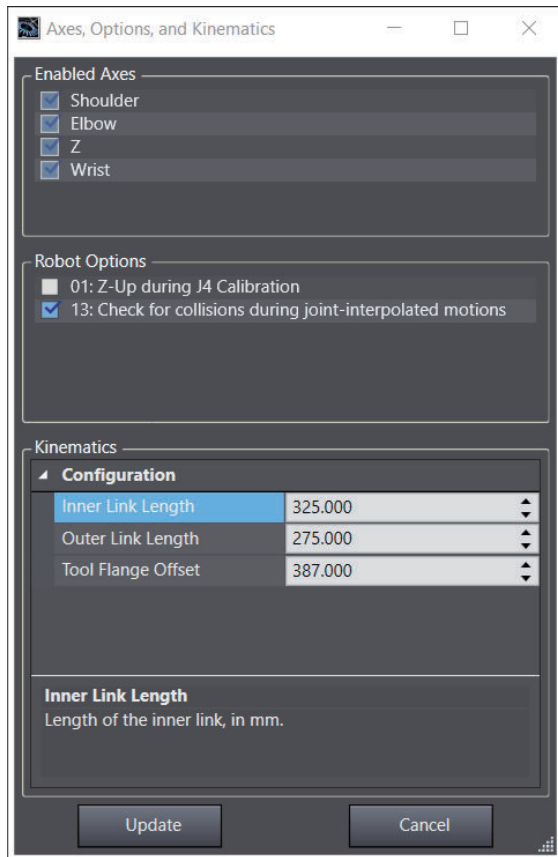

### ● Enabled Axes

The Enabled Axes area is used to enable / disable the joints (axes) of the robot. If the robot does not have joints that can be enabled / disabled, the Enabled Axes check boxes will be disabled.

### ● Robot Options

The Robot Options area is used to select the robot option bits for your robot. Refer to the table below for some common option bits.

Item	Description
Free mode power OFF	Robot power is turned OFF rather than disabling the individual amplifier.
Execute CALIBRATE command at boot	Calibrate the robot after the V+ operating system boots. Only works if the robot can calibrate with power OFF. It does not work on Cobra robots because they must move joint 4 during calibration.
Check joint interpolated collisions	While moving, check for obstacle collisions even for joint-interpolated moves. This bit causes slightly more CPU usage if set, because it requires the robot to perform a kinematic solution that is not part of the normal operation.
Z-up during J4 calibration	On Cobra robots, J4 must rotate slightly during calibration. This bit makes J3 to retract before moving J4.
J6 multi-turn	This bit allows infinite rotation of J6. Note that individual moves must be no more than 360 degrees.
Software motor limits	In robot models with multiple motors coupled to move a single joint, the standard joint motion limits may not be adequate to prevent the motors from hitting physical limits. In such cases, you may use software motor limits to restrict motor motion.

## ● Kinematics

The Kinematics area is used to display the kinematic parameters for your robot.

## Obstacles

Select Obstacles to add/edit the location, type, and size of workcell. The **Edit Obstacles** dialog box is opened.



### Precautions for Correct Use

Obstacles are predefined, and evaluated in the controller when a robot motion instruction is executed. It is not the same as Collision Detection in the 3D Visualizer. Refer to *7-2-4 Collision Detection Settings* on page 7-19 for more information.

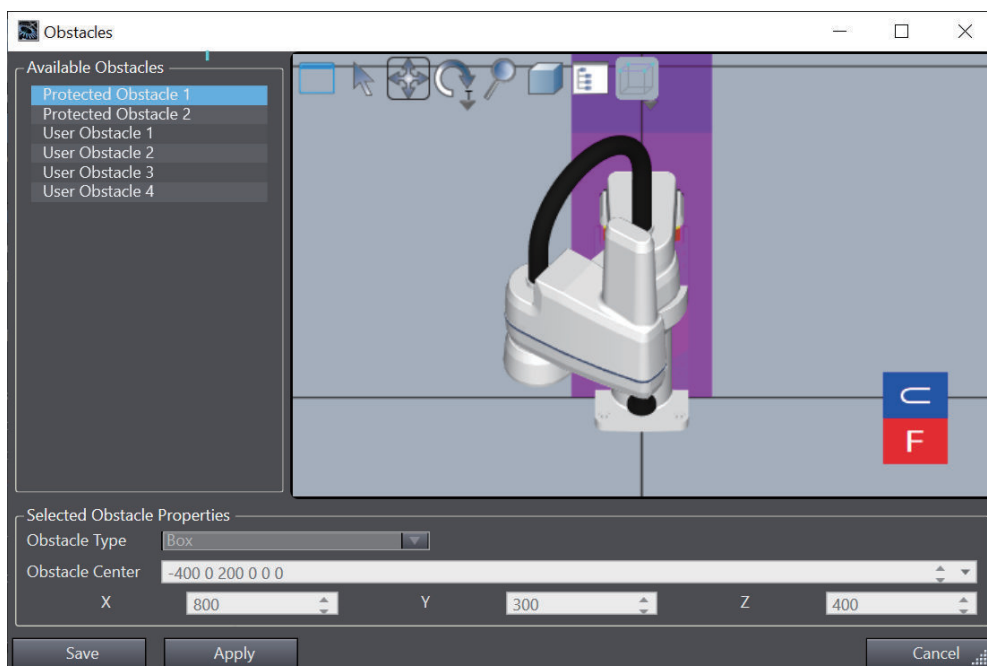

	Item	Description
Available obstacles	Protected Obstacles	Predefined system obstacles that cannot be edited by the user.
	User Obstacles	Each row provides an entry for a workcell obstacle.
Selected Obstacle Properties	Obstacle Type	This drop-down list is used to select the type of obstacle: box, cylinder, sphere or frustum. These types are also offered as containment obstacles for applications where you want to keep the robot working within a defined area.
	Obstacle Center	This text box is used to enter the coordinates of the center of the obstacle.
	Obstacle Dimensions	Dimensions such as diameter and height are required depending on the obstacle type chosen.

## S-Curve Profiles

The **S-Curve Profile** dialog box is used to configure the four time values required to create a new s-curve profile for use in robot motion (also called a trapezoidal acceleration curve). Selecting **S-Curve Profiles** will display the **S-Curve Profiles** dialog box.

Refer to ACCEL program instruction in *eV+3 Keyword Reference Manual (Cat. No. I652)* for details.

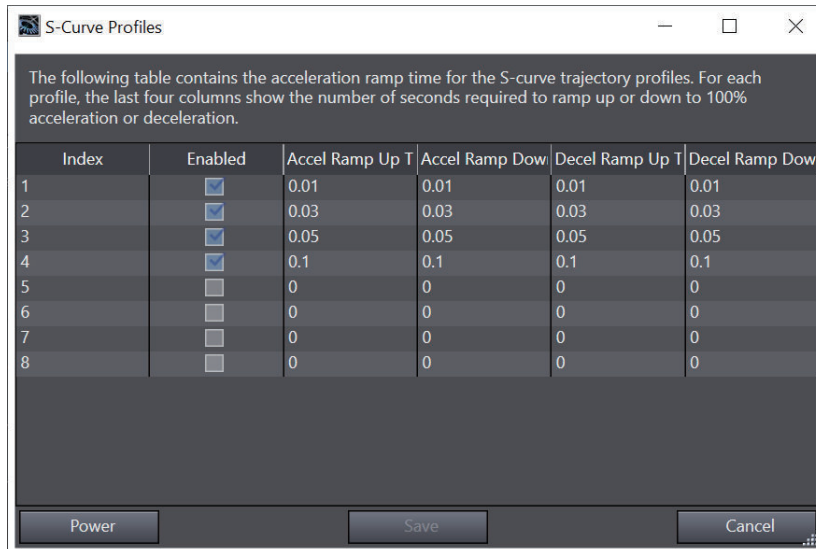

### ● Considerations on S-Curve Profiles

An S-Curve Profile is a trajectory that has a trapezoidal acceleration profile, giving an S-shaped velocity profile. The benefit of a trapezoidal acceleration profile is that the rate of change of acceleration can be controlled for a smoother motion.

For many mechanisms, controlling the acceleration is significant because high values can cause the mechanical structure of the robot to vibrate. Minimizing structural vibrations is especially important at the end of a motion, since such oscillations can adversely affect the settling time of the robot, which can affect the cycle time. However, for stiff, strong mechanisms a square-wave profile may result in shorter cycle times.

For a general trapezoidal profile, there are four time values that can be specified.

1. Ramp up to maximum acceleration
2. Ramp down from maximum acceleration
3. Ramp up to maximum deceleration
4. Ramp down to zero acceleration

Each of these four acceleration values can be individually specified and a set of the four values defines a specific acceleration *profile* for use in programming robot motion routines.

## Safety Settings

Safety Settings are used to restore the factory default settings when the system has delay in the hardware for emergency stop or the speed is limited in the Teach mode. Selecting **Safety Settings** displays the following dialog box which contains the items described below.



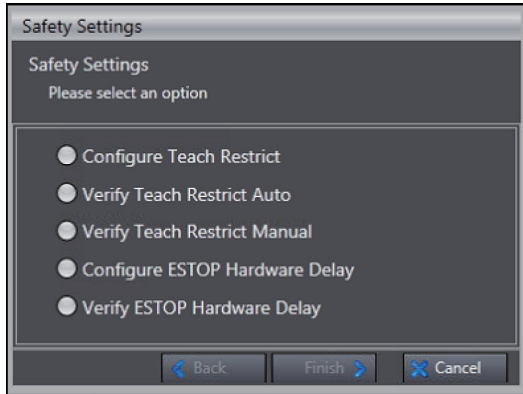

### Precautions for Correct Use

The Safety Settings function is not available in the EMULATION mode.

#### ● Teach Restrict Setting

Select **Configure Teach Restrict** and click **Next**. Then, you can proceed the process to set the speed limit, which you have previously determined, to each robot motor.

The Teach Restrict function intends to follow the safety restrictions that require a speed limit when the robot is in the manual mode. It is a hardware-based safety function, which prevents the robot's quick movements in the manual mode despite of a software error that operates the robot faster than a permissible value. When you are performing a jog operation in the manual mode, and a joint moves at an excessive speed beyond a configured limit, your system will disable the High Power.



### Precautions for Correct Use

This configuration process adjusts the amplifier unit circuit depending on the features of each motor. The process must be implemented when the amplifier is changed in the existing system.

#### ● Verify Teach Restrict Auto

Select **Verify Teach Restrict Auto** and click **Next**. Then, you can proceed the process to confirm the Teach Restrict works properly on the series of automatically instructed movements.

#### ● Verify Teach Restrict Manual

Select **Verify Teach Restrict Manual** and click **Next**. Then, you can proceed the process to confirm that the Teach Restrict works properly on the series of jog operations performed through the T20 pendant. It is effective to troubleshoot or test joints for a Teach Restrict commissioning or a rejected auto verification.

#### ● Configure ESTOP hardware delay

Select **Configure ESTOP hardware delay** and click **Next**. Then, you can proceed the process to configure a delay time on the ESTOP timer circuit.

The purpose of the ESTOP hardware delay function is to follow the safety restrictions that requires the robot to disable the High Power at an emergency stop even if the software does not issue an instruction.

- **Verify ESTOP hardware delay**

Select **Verify ESTOP hardware delay** and click **Next**. Then, you can proceed the process to verify that the robot's High Power is disabled without software's instruction when an emergency stop is triggered.

### 5-6-4 IO EndEffectors

Configure IO EndEffectors. End-effector, also called tool or gripper, can be used in picking, placing, dispensing, or other functions common to robotic applications.

End effectors can grip, extend, retract, or dispense.



#### **Additional Information**

---

Configuration is not necessary if you use the Robot Integrated CPU Unit only. Refer to *Sysmac Studio Robot Integrated System Building Function with IPC Application Controller Operation Manual (Cat. No. W621)* for details.

---

# 6

## Programming

This section provides the procedures to create robot control programs.

---

<b>6-1</b>	<b>Creating Programs .....</b>	<b>6-2</b>
<b>6-2</b>	<b>Creating V+ Programs .....</b>	<b>6-3</b>
6-2-1	Structure of V+ Program.....	6-3
6-2-2	Registering V+ Variables .....	6-3
6-2-3	Creating New V+ Programs.....	6-10
6-2-4	V+ Program Editor.....	6-12
<b>6-3</b>	<b>Task Settings .....</b>	<b>6-16</b>

## 6-1 Creating Programs

---

Robot Integrated CPU Units can control robots through sequence control programs or V+ programs. This section describes how to create V+ programs by the Sysmac Studio.

Create sequence control programs by using Ladder Editor or ST Editor provided by Sysmac Studio. Refer to *Sysmac Studio Version 1 Operation Manual (Cat. No. W504)* for how to use Ladder Editor or ST Editor.



---

### Additional Information

If you control the robot by sequence control programs, use robot control instructions defined as function block. Robot control instructions can be used to run or abort V+ programs. Refer to *NJ-series Robot Integrated CPU Unit User's Manual (Cat. No. O037)* for details of specifications and usage of robot control instructions.

---

## 6-2 Creating V+ Programs

V+ program is a robot control algorithm described in the V+ language. To create a V+ program, register V+ variables and write codes with a V+ program editor.

Refer to *NJ-series Robot Integrated CPU Unit User's Manual (Cat. No. O037)*, *eV+3 User's Manual (Cat. No. I651)*, and *eV+3 Keyword Reference Manual (Cat. No. I652)* for details of specifications and usage of V+.

### 6-2-1 Structure of V+ Program

V+ program is shown and managed by Sysmac Studio.

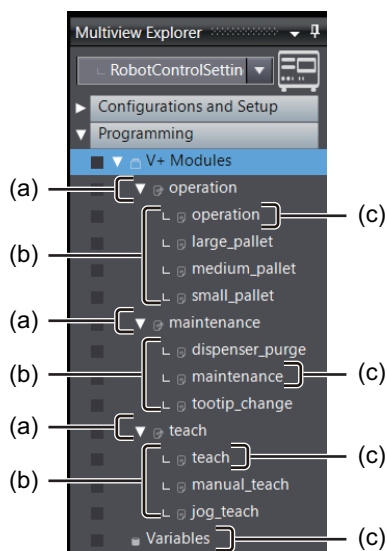

	Item	Description
(a)	V+ Module	Group of V+ programs. V+ module names are displayed.
(b)	V+ Program	Program written in V+.
(c)	V+ Module Program	Basic V+ program used for V+ module name. The name of V+ module program is shown as V+ module name.
(d)	V+ Variable	V+ global variables used commonly in all V+ programs are registered.

### 6-2-2 Registering V+ Variables

There are three types of V+ variables: global variables, external variables, and local variables. Global variables can be used in all V+ programs as common variables. A *V+ variable* means a global variable in this manual unless otherwise described. Refer to *eV+3 User's Manual (Cat. No. I651)* for details about external variables and local variables.

You can register V+ variables with V+ Variable Editor. This section provides you the information about V+ variable types and how to register the variables using V+ Variable Editor.

## ⚠ WARNING

Check operations of the created user programs, data, and setting values carefully before proceeding to normal operation.



## V+ Variable Type

There are the following types of V+ variables.

Type	Description
Real	Floating-point data type used to represent a real number.
String	Text-based data type used to represent character strings. Valid string characters include 128 8-bit ASCII characters.
Location	<p>Specifies the position and orientation of the robot tool tip in three-dimensional space. You can define robot locations using Cartesian coordinates (transformations).</p> <p>A transformation is a set of six components that identifies a location in Cartesian space and the orientation of the robot tool flange (X, Y, Z, Yaw, Pitch, Roll). A transformation can also represent the location of an arbitrary local reference frame (also known as a <i>frame of reference</i>).</p> <p>The coordinate offsets are from the origin of the World coordinate system which is located at the base of the robot by default.</p> <p>V+ Variable location values can be manually entered or acquired from the current robot position. Refer to 7-3 V+ Jog Control on page 7-20 for details.</p>
Precision Point	<p>Defines a location by specifying a value for each robot joint. These joint values are absolute and cannot be made relative to other locations or coordinate frames. Precision point locations are useful for jointed-arm applications and with applications that require full rotation of robot arms with joint 4.</p> <p>They are also helpful where joint orientation is critical to the application or when you want to move an individual joint.</p>

## Starting V+ Variable Editor

Start the V+ Variable Editor following the procedure below.

- 1 Select *RobotControlSettings* from a project's device list.

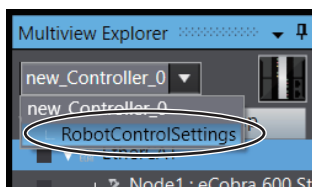

Multiview Explorer displays **Configurations and Setup** and **Programming** of the Robot Control Function Module.

- 2 Right-click **Variables** in **Programming** under Multiview Explorer. Then select **Edit**. Or, double-click it.  
The V+ Variable Editor is displayed.

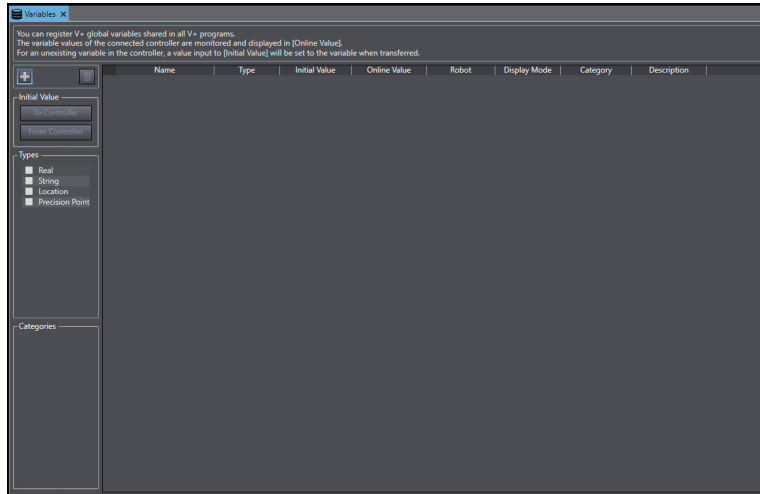

## V+ Variable Editor

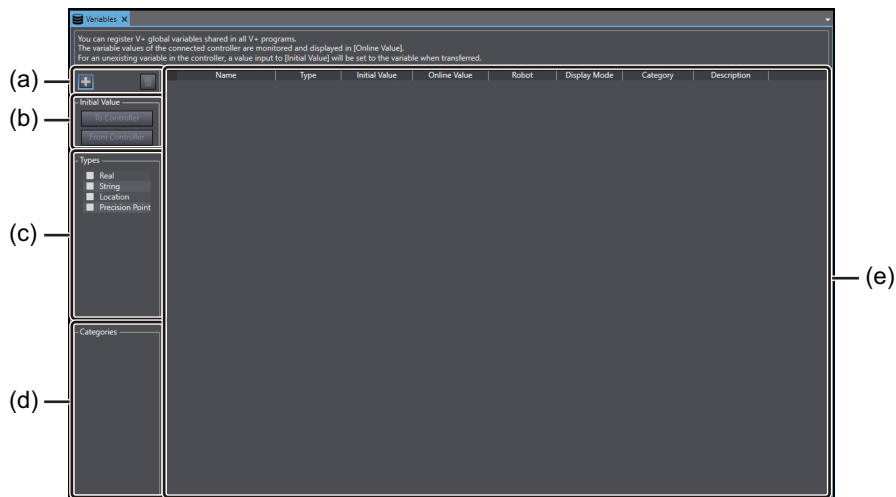

	Item	Description	
(a)	Add/Delete buttons	Add or delete a V+ variable.	
(b)	Initial Value*1	To Controller	For the variables in the variable table that have already been transferred to the controller, use this button to set the values in the <b>Initial Value</b> column as the controller's variable values.
		From Controller	For the variables in the variable table that have already been transferred to the controller, use this button to set the controller's variable values as the values in the <b>Initial Value</b> column.
(c)	Types	You can select types of variable to be displayed in the variable list. Checked variable types are shown. If no types checked, all types of variables are displayed.	
(d)	Categories	You can select categories of variable to be displayed in the variable list. Checked variable categories are shown. If no categories checked, all categories of variables are displayed.	

Item		Description
(e)	Variable list	
	Name	Names of V+ variables are shown.
	Type	Types of V+ variables are shown.
	Value*2	The variable values in the controller that is connected online are monitored and shown.
	Initial Value*1	Initial values are shown.
	Online Value*1	The variable values in the controller that is connected online are monitored and shown.
	Robot	Robots that assigned to variables are displayed.
	Display Mode	Location or precision point variable appears in the 3D Visualizer in the following modes. <ul style="list-style-type: none"> <li>Do not display: the point will not appear in the 3D Visualizer</li> <li>Display as point: the point will appear as a circle</li> <li>Display as frame: the point will appear as a coordinate symbol</li> </ul>
	Category	Categories of variables are displayed.
Description	Descriptions of variables are displayed.	

\*1. This item is displayed when you select **[Initial Value] and [Online Value] column** for **[Value] column setting** in **V+ Variables** in the Option dialog box.

\*2. This item is displayed when you select **Only [Value] column** for **[Value] column setting** in **V+ Variables** in the Option dialog box.



### Additional Information

You can copy variables from Excel or other spreadsheet software and paste them into the V+ Variable Editor.

## Initial Value and Online Value

The following describes the details of values displayed in the **Initial Value** and **Online Value** columns in the V+ Variable Editor. To operate the values displayed in the **Initial Value** and **Online Value** columns, select the **[Initial Value] and [Online Value] column** option for **[Value] column setting** in **V+ Variables** in the Option dialog box.

### ● Initial Value

Name	Type	Initial Value	Online Value	Robot	Display Mode	Category	Description
location_array[]	Location						
location_array[0]	Location	450.000 0.000 350.000 0.00	400.000 0.000 350.000 0.00	R1 Cobra600	Do not display		
location_array[1]	Location	300.000 10.000 350.000 0.0	300.000 10.000 350.000 0.0	R1 Cobra600	Do not display		
location_var	Location	450.000 100.000 350.000 0	450.000 0.000 350.000 0.00	R1 Cobra600	Do not display		
real_array[]	Real						
real_array[0]	Real	4	5				
real_array[1]	Real	5	4				
real_var	Real	3	3				

When you are offline, you can set initial values in the V+ Variable Editor. You cannot edit the initial values when you are online or executing a simulation.

The initial values will be set in the Controller's variable when you perform the following operations or start up the Robot Integrated CPU Unit.

- Transferring the project  
Refer to *8-1-3 Transferring the Project* on page 8-2 for information on transferring the project.
- Writing data to the V+ memory



Refer to 7-10-3 *Writing Data to the V+ Memory* on page 7-68 for details on writing data to the V+ memory.

- Starting up the Robot Integrated CPU Unit
 

To set the initial values in the Controller's variable at startup of the Robot Integrated CPU Unit, you need to perform the following operations.

  1. Under **Configurations and Setup** in the Multiview Explorer, double-click **Save Configuration**, then click the **Generate Auto Module** button in the **Save Configuration** tab page to update the Auto Module (AUTO.V2). Refer to 5-5-2 *Save Configuration* on page 5-21 for generating an Auto Module.
  2. Under **Configurations and Setup** in the Multiview Explorer, double-click **Controller Settings** to open the **Controller Settings** tab page. Then, click the **Configure** button, select **Configure System Settings**, and select the **Auto Start** check box. Once you perform this operation online, the setting will remain effective after that time. Refer to 5-5-1 *Controller Settings* on page 5-9 for details on the Controller settings.



### Additional Information

When you transfer V+ variables, the behavior of the transfer function depends on the presence/absence of the target variables in the Controller and PC. Refer to 7-10-5 *Notes on Transferring V+ Variables* on page 7-70 for details.

### ● Online Value

Name	Type	Initial Value	Online Value	Robot	Display Mode	Category	Description
location_array[]	Location	450.000 0.000 350.000 0.000	400.000 0.000 350.000 0.000	1 Cobra600	Do not display		
location_array[0]	Location	450.000 0.000 350.000 0.000	400.000 0.000 350.000 0.000	1 Cobra600	Do not display		
location_array[1]	Location	300.000 10.000 350.000 0.000	300.000 10.000 350.000 0.000	1 Cobra600	Do not display		
location_var	Location	450.000 100.000 350.000 0.000	450.000 0.000 350.000 0.000	1 Cobra600	Do not display		
real_array[]	Real						
real_array[0]	Real	4	5				
real_array[1]	Real	5	4				
real_var	Real	3	3				

This column shows the Controller's variable values that are monitored when you are online or executing a simulation. When you are online and in V+ Edit mode, you can overwrite the Controller's variable values by editing the online values.

## Registering V+ Variables

Register a V+ variable following the procedure below.

- 1 Click the **Add** button in the V+ Variable Editor. The **Add a new variable** dialog box appears.

**2** Set each item, then click the **Accept** button.

A new V+ variable is created and displayed on the V+ Variable Editor.

### ● Add a New Variable Dialog Box

Item	Description
Variable Name	<p>Enter a unique variable name.</p> <p>V+ variable must be named according to the following rules.</p> <ul style="list-style-type: none"> <li>• Real and Location variables must begin with a letter and can be followed by any sequence of letters, numbers, periods, and underscores.</li> <li>• String variables must begin with the \$ symbol and can be followed by any sequence of letters, numbers, periods, and underscores.</li> <li>• Precision Point variables must begin with the # symbol and can be followed by any sequence of letters, numbers, periods, and underscores.</li> <li>• There is a 15 character limit for variable names.</li> <li>• Variables are not case sensitive and always default to lower-case letters.</li> <li>• Because Sysmac Studio automatically creates default system variable names, avoid creating variable names that begin with two or three letters followed by a period to prevent coincidental variable name duplications. For example, sv.error, tsk.idx, and tp.pos1 are variable names that should be avoided. This restriction applies when creating variables in the V+ Editor and within V+ programs.</li> </ul>
Variable Type	Select a V+ variable type.
Description	Enter a description.

Item	Description	
Category	A category can be defined for each variable to help classify and organize variables. V+ variables can be saved by category as well. Refer to 5-5-2 <i>Save Configuration</i> on page 5-21 for details.	
Value	Set an initial value for a V+ variable.	
Robot*1	Assign a robot to a location or precision point variable. When assigning a robot current position to the location or precision point variable, a robot must be selected. The robot must be assigned for display purposes and for inclusion in location lists provided by the V+ Jog Control.	
Display Mode*1	Select a display mode on the 3D Visualizer for a location or precision point variable.	
Array	Index Count	If this variable is an array, check this box to select the array dimensions. You can set one to three-dimensional arrays.
	Starting Index	Set a starting number of each array index.
	Ending Index	Set a ending number of each array index.

\*1. Displayed only for the location or precision point type.

## Other V+ Variable Editor Functions

To use the following functions, right-click a variable in the V+ Variable Editor.

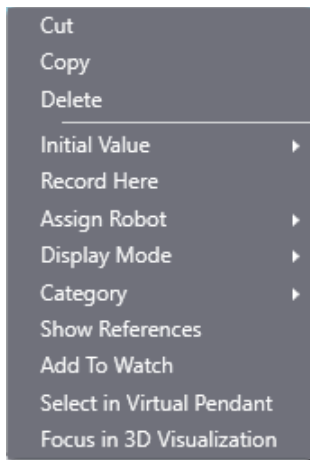

Item	Description	
Cut/Copy/Paste/Delete	Cut, copy, paste, or delete variables.	
Initial Value*1	To Controller	For the selected variables that have already been transferred to the controller, use this button to set the values in the <b>Initial Value</b> column as the controller's variable values.
	From Controller	For the selected variables that have already been transferred to the controller, use this button to set the controller's variable values as the values in the <b>Initial Value</b> column.
Record Here*2	Acquire the robot's current position values and apply them to the <b>Initial Value</b> and <b>Online Value</b> columns, or the <b>Value</b> column. This option is only available if a robot has been assigned in the variable.	
Assign Robot*2	Select a robot to assign to the selected variable.	
Display Mode*2	Select a mode to display in the 3D Visualizer.	

Item	Description
Category* <sup>3</sup>	Change the category of selected variable.
Show References	<b>Show References</b> dialog box appears to display a list of program references where the selected variable is used. If the variable is used in program, the program name and line numbers are provided to locate exactly where the variable is used. Clicking a line number will display the program reference.
Add to Watch	Selected variable is placed on the Watch Tab Page. Refer to 7-9-1 <i>Variable Monitoring</i> on page 7-61 for details.
Select in Virtual Pendant* <sup>2</sup>	<b>V+ Jog Control</b> Pane is opened to add the selected variable to the Location area. This is a convenient method for jogging and teaching a robot position for a variable. Only available if robot has been assigned in the variable. Refer to 7-3 <i>V+ Jog Control</i> on page 7-20 for details.
Focus in 3D Visualization* <sup>2</sup>	3D Visualizer is opened, and coordinates of the selected variable are shown in the center.

\*1. This item is displayed when you select **[Initial Value]** and **[Online Value]** column for **[Value]** column setting in **V+ Variables** in the Option dialog box.

\*2. Displayed only for the location or precision point type.

\*3. Displayed when any value is selected in the Category field in the V+ Variable Editor.

### 6-2-3 Creating New V+ Programs

The following section describe how to add V+ programs. V+ programs are created as the data of the Robot Integrated CPU Unit's subdevice, *RobotControlSettings*.

- 1 Select *RobotControlSettings* from a project's device list.

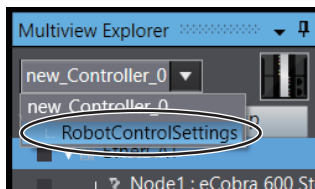

Multiview Explorer displays **Configurations and Setup** and **Programming** of the Robot Control Function Module.

- 2 Select **Programming** from Multiview Explorer. Then right-click **V+ Modules** to select **Add New Module**.

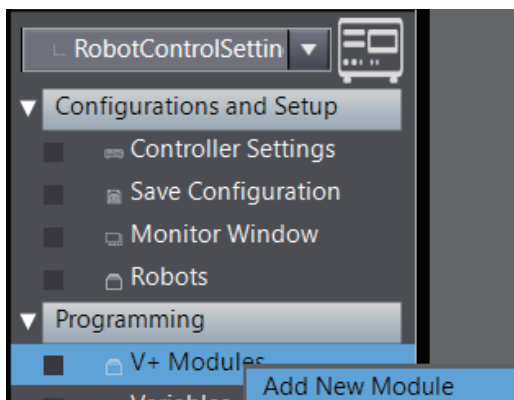

The V+ module *program0* and V+ module *program0* are added.

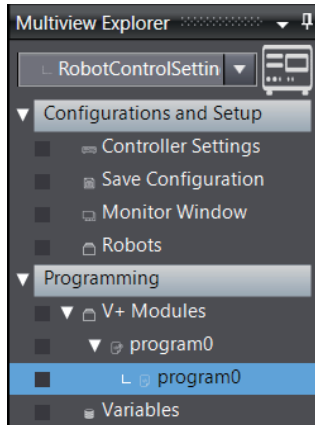

- 3** Double-click V+ program, *program0*. Or, right-click and select **Edit**.  
V+ Program Editor Tab Page is displayed in the Edit Pane.

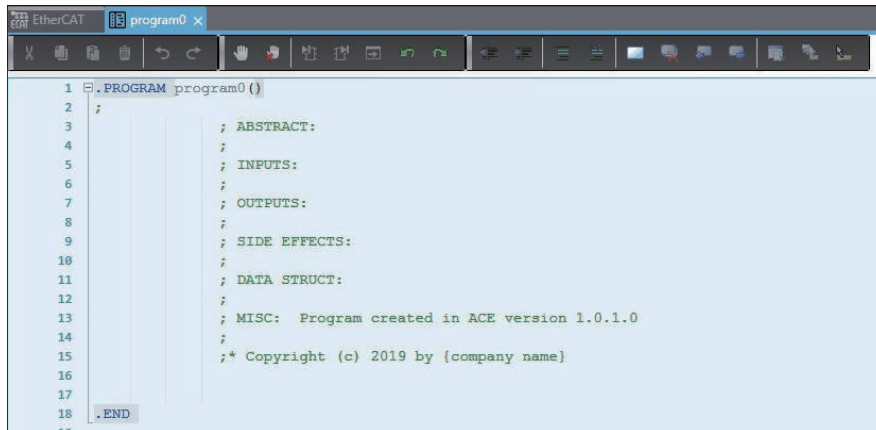

Refer to 6-2-4 V+ Program Editor on page 6-12 for details about buttons and functionalities of V+ Program Editor.



### Precautions for Correct Use

- The same name will be given to the V+ module and V+ module program that are created together with the V+ module. If the name of the V+ module program is changed, V+ module name will be also changed.
- The V+ module added or changed by the following operations will not be loaded into the V+ memory when the power supply to the Robot Integrated CPU Unit is cycled.

- a) Adding a new V+ module
- b) Renaming a V+ module

To automatically load the added or changed V+ module into the V+ memory by cycling the power supply, use the following procedure.

- 1) Under **Configurations and Setup** in the Multiview Explorer, double-click **Save Configuration**, then click the **Generate Auto Module** button in the **Save Configuration** tab page to update the Auto Module (AUTO.V2).  
This operation is required each time you add a new V+ module or rename a module. Refer to *5-5-2 Save Configuration* on page 5-21 for generating an Auto Module.
- 2) Under **Configurations and Setup** in the Multiview Explorer, double-click **Controller Settings** to open the **Controller Settings** tab page. Then, click the **Configure** button, select **Configure System Settings**, and select the **Auto Start** check box.  
Once you perform this operation online, the setting will remain effective after that time. Refer to *5-5-1 Controller Settings* on page 5-9 for details on the Controller settings.



### Additional Information

- You can define a V+ program as V+ module program. Right-click the V+ program on Multiview Explorer and then, select **Set as Module Program**.
- A string set by default will be inserted to the header of newly added V+ program. Insertion and strings can be modified in Option Settings. Refer to *A-1 Option Settings* on page A-2 for details.

## 6-2-4 V+ Program Editor

Buttons and functionalities of the V+ Program Editor are given below.

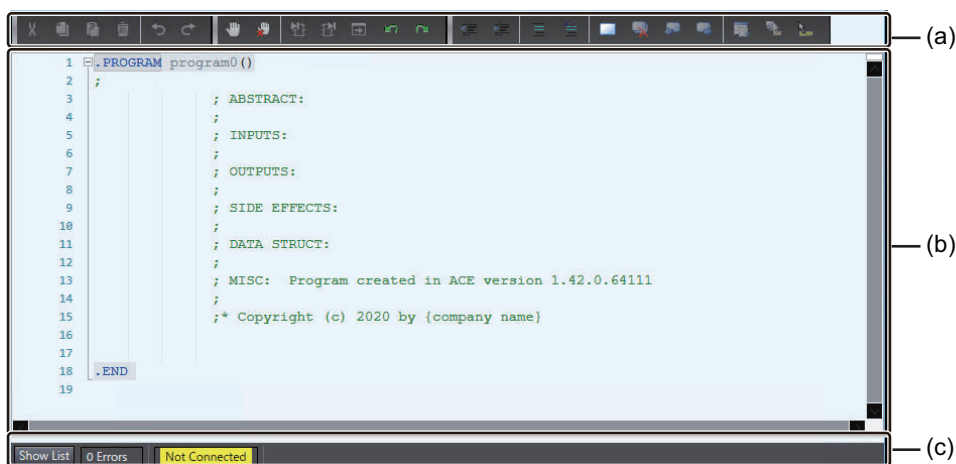

	Item	Description
(a)	Toolbar	The function buttons used to create V+ Programs are displayed. Refer to <i>Toolbar in V+ Program Editor</i> on page 6-13 for details.
(b)	Editor	You can create V+ programs using this editor. Refer to <i>How to Use V+ Program Editor</i> on page 6-13 for the programming procedure.
(c)	Status	Errors and online connection conditions are shown.

## Toolbar in V+ Program Editor

The following table gives the functionalities of buttons in the tool bar.

Place the mouse over a button icon, and the description is displayed in a tool tip.



	Item	Description
(a)	Cut	Cut the selected text
	Copy	Copy the selected text
	Paste	Paste the text saved in Clipboard to a cursor position
	Delete	Delete the selected text
(b)	Undo	Cancel the last operation
	Redo	Cancel the last operation
(c)	Toggle breakpoint at current line	Set/clear a breakpoint for debugging in the selected line
	Clear all breakpoints	Clear all breakpoints in the displayed V+ program
	Step into	Used for debugging. Refer to 7-8 <i>Debugging Robot Movement</i> on page 7-59 for details.
	Step over	
	Jump to current line and step	
	Retry line	
	Proceed execution	
(d)	Outdent	Outdent the selected line left by 1
	Indent	Indent the selected line right by 1
	Comment Selection	Comment out the selected line. A semicolon ; will be put at the head of the line. The text in the commented out line will be shown in green.
	Uncomment Selection	Delete the semicolon ; at the head of the selected line to uncomment
	Toggle Bookmark	Bookmark or drop bookmark the line where the cursor points. The bookmark icon will be displayed at the left of the line.
	Clear Bookmarks	Clear all bookmarks
	Previous Bookmark	Jump to the line with previous bookmark
	Next Bookmark	Jump to the line with next bookmark
(e)	Display an Object Member List	Available codes are displayed in the drop-down list. Keyword list is displayed at where a keyword can be entered, and a parameter list at where a parameter of keyword can be entered.
	Display Parameter Info	Parameter of the selected keyword is shown in a tool chip
	Display Quick Info	Information about the parameter or variable of the selected keyword is shown in a tool chip

## How to Use V+ Program Editor

The following section describes basic coding method of V+ program.

Refer to *eV+3 User's Manual (Cat. No. I651)* for syntax and description rules of V+ program.

- 1 Enter the first letter of the keyword you want on the V+ Program Editor.

Possible keywords will be displayed in the drop-down list.

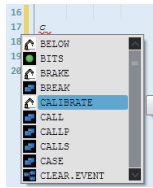

- 2 Select the keyword and press the Enter key.  
Keyword is entered.



- 3 Press the F2 or click the **Display an Object Member List** button.  
Possible parameters for the keyword are displayed.

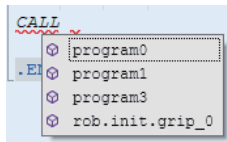

- 4 Select a parameter and press the Enter key.
- 5 After entering all necessary parameters and items, press the Enter key to begin a new line.



#### Precautions for Correct Use

Define V+ variables in the V+ Variable Editor.

You can declare a V+ variable in a V+ program, but the V+ variable may not agree when the program synchronized.

When a V+ variable is declared in a V+ program, execution of the declaration line generates dynamically the variable on the memory, then updates the V+ variable list on the V+ memory. It makes a difference between the V+ variable list in the V+ Variable Editor, which defined in a Sysmac Studio project, and causes a discrepancy at a synchronization. To resolve the variable discrepancy, execute *Push to V+ Memory* or *Pull from V+ Memory*.

## Menus of V+ Program Editor

The following right-click menus are available in the V+ Program Editor.



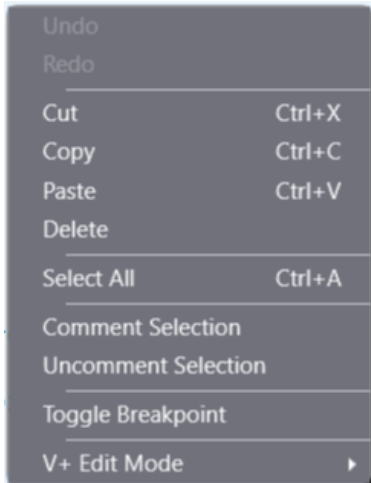

Menu command	Description
Undo	Cancel the last operation
Redo	Cancel the last operation
Cut	Cut the selected text
Copy	Copy the selected text
Paste	Paste the text saved in Clipboard to a cursor position
Delete	Delete the selected text
Select All	Select all texts on the Editor
Comment Selection	Comment out the selected line. A semicolon ; will be put at the head of the line. The text in the commented out line will be shown in green.
Uncomment Selection	Delete the semicolon ; at the head of the selected line to uncomment
Toggle Breakpoint	Set/clear breakpoints for debugging in the selected line
V+ Edit Mode – <b>Start/Exit</b>	Start/exit the V+ Edit Mode.

## 6-3 Task Settings

Task period of the Robot Integrated CPU Unit must be 2 ms or more when you use an Omron robot. If task period of a primary periodic task has an error when a robot is added in the EtherCAT Configuration Tab Page, modify the task period following the procedure below.

- 1 Select a Controller from the device list in Multiview Explorer.
- 2 Double-click **Task Settings** in Multiview Explorer.  
The Task Settings Tab Page is displayed.

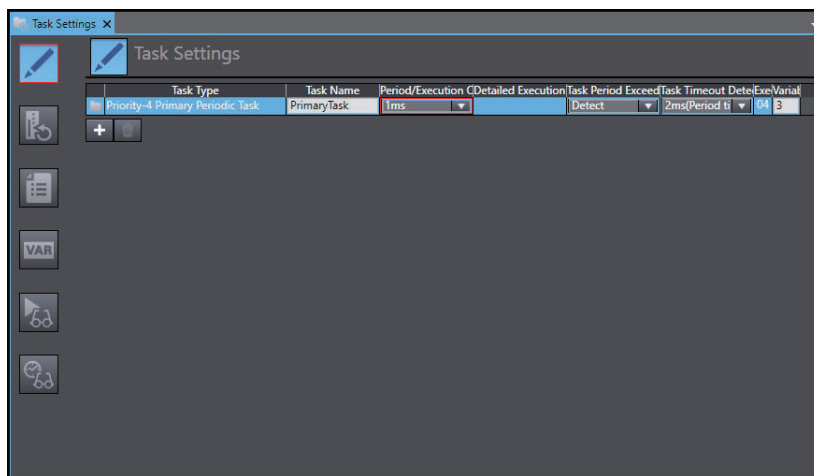

Select 2 ms or more for **Period/Execution Conditions** of Primary periodic task.

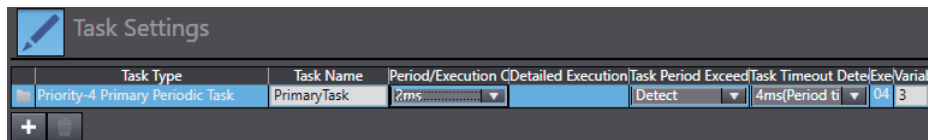

# 7

## Debugging Robot Integrated System

This section provides functions and usage instruction of debugging Robot Integrated System.

<b>7-1</b>	<b>Overview of Debugging Robot Integrated System</b> .....	<b>7-3</b>
7-1-1	Schema of V+ Program Offline Debug .....	7-3
<b>7-2</b>	<b>3D Visualizer</b> .....	<b>7-4</b>
7-2-1	3D Visualizer Basic Features .....	7-4
7-2-2	Creating 3D Workspace .....	7-4
7-2-3	Description of Icons .....	7-4
7-2-4	Collision Detection Settings.....	7-19
<b>7-3</b>	<b>V+ Jog Control</b> .....	<b>7-20</b>
7-3-1	Starting V+ Jog Control .....	7-20
7-3-2	V+ Jog Control Setting Items.....	7-21
<b>7-4</b>	<b>Task Status Control</b> .....	<b>7-28</b>
7-4-1	Starting Task Status Control .....	7-28
7-4-2	Displayed Items in Task Status Control.....	7-29
7-4-3	Robot Integrated CPU Unit Settings Items .....	7-31
7-4-4	Task Manager.....	7-31
7-4-5	IO Watcher .....	7-34
7-4-6	V+ File Browser .....	7-34
7-4-7	Virtual Front Panel.....	7-36
<b>7-5</b>	<b>Overview of Robot Integrated System Simulation</b> .....	<b>7-39</b>
7-5-1	Schema of Robot Integrated System Simulation.....	7-39
<b>7-6</b>	<b>How to Start Simulation</b> .....	<b>7-41</b>
7-6-1	Activating Robot Simulation Function.....	7-41
7-6-2	Starting Robot Simulation.....	7-42
<b>7-7</b>	<b>Teaching Robots</b> .....	<b>7-43</b>
7-7-1	Preparing V+ Location Variables .....	7-43
7-7-2	Teaching on 3D Visualizer .....	7-43
7-7-3	Teaching on V+ Jog Control Pane.....	7-47
7-7-4	Saving Current Robot Position .....	7-50
7-7-5	Teaching with Robot Path Planning.....	7-52
<b>7-8</b>	<b>Debugging Robot Movement</b> .....	<b>7-59</b>
7-8-1	Commissioning the Robot .....	7-59
<b>7-9</b>	<b>Program Debugging</b> .....	<b>7-61</b>
7-9-1	Variable Monitoring.....	7-61
7-9-2	Program Debugging .....	7-61

7-9-3	System Monitor .....	7-62
<b>7-10</b>	<b>Transferring V+ Programs and V+ Variables .....</b>	<b>7-64</b>
7-10-1	Checking the V+ Memory .....	7-64
7-10-2	Synchronization .....	7-64
7-10-3	Writing Data to the V+ Memory .....	7-68
7-10-4	Getting Data from the V+ Memory .....	7-69
7-10-5	Notes on Transferring V+ Variables .....	7-70

# 7-1 Overview of Debugging Robot Integrated System

To debug the Robot Integrated System, two debugging methods by Sysmac Studio's 3D simulation function are available: Offline debug and Online debug to be performed connected with an actual machine. Regarding the debug functions of the Sysmac Studio, operation procedures for common functions with Online and Offline debugs and specific functions of Online/Offline debug are described in the following.

Refer to *Sysmac Studio Version 1 Operation Manual (Cat. No. W504)* for the debug function of sequence control program.

## 7-1-1 Schema of V+ Program Offline Debug

This section describes Offline debug by simulation.

After a simulation starts, the V+ emulator boots up on Sysmac Studio. The following functions will be available once Sysmac Studio get connected to V+ emulator.

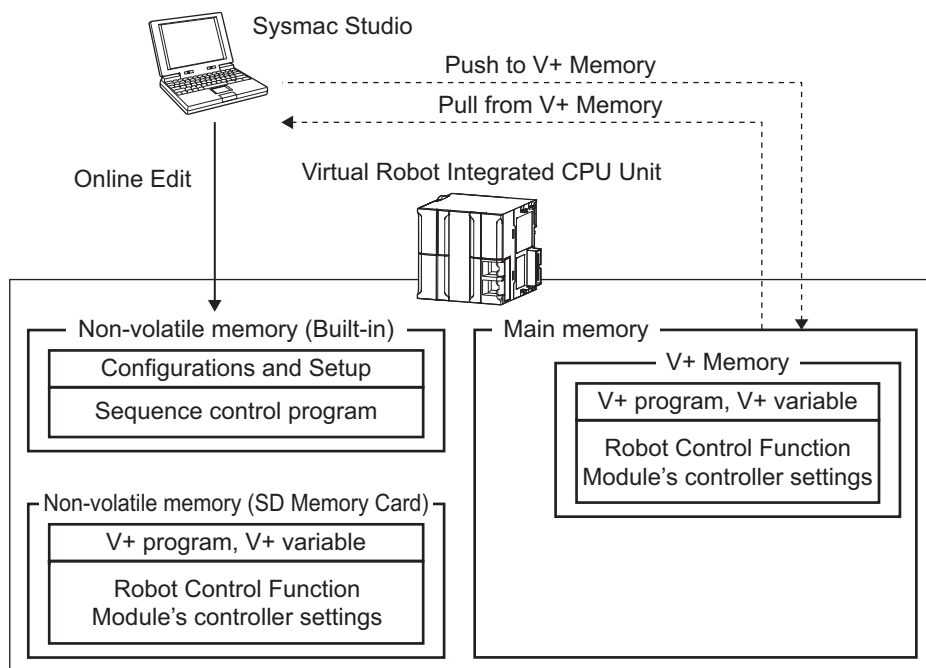

Function	Description	Reference
Online Edit	You can edit sequence control programs in the built-in non-volatile memory directly.	<i>Sysmac Studio Version 1 Operation Manual (Cat. No. W504)</i>
Push to V+ Memory	Transfer V+ programs and V+ variables in Sysmac Studio to the main memory.	7-10-3 Writing Data to the V+ Memory on page 7-68
Pull from V+ Memory	Transfer V+ programs and V+ variables in the main memory to Sysmac Studio.	7-10-4 Getting Data from the V+ Memory on page 7-69
Check V+ Memory	Compare V+ programs and V+ variables in the main memory with those in Sysmac Studio.	7-10-1 Checking the V+ Memory on page 7-64

## 7-2 3D Visualizer

The 3D Visualizer allows you to see simulated 3D motions of fixed objects (e.g. robot, rack), obstacles, mechanical components, and parts, which located on the screen. The 3D Visualizer displays the following information:

- Graphical representation of all robots, fixed objects, and obstacles in the workspace
- Robot work envelopes
- Teach points and other part locations



### Additional Information

To simulate mechanical component movements, Sysmac Studio 3D Simulation Option License is required. Refer to *Sysmac Studio 3D Simulation Function Operation Manual (Cat. No. W618)* for details.

### 7-2-1 3D Visualizer Basic Features

The 3D Visualizer has several functions to develop and test a Robot Integrated System easier. The 3D Visualizer tools are available in the EMULATION mode and also while connected to physical controllers.

- 2D and 3D recording for playback in the Offline Visualizer
- Collision detection in the EMULATION mode
- Measurement of distance between 3D objects
- Robot jogging
- Location visualization and editing

The following sections describe operations and functions of 3D Visualizer.

### 7-2-2 Creating 3D Workspace

To use the 3D Visualizer, an accurate 3D workspace must be created to represent all objects of concern in the application. Use the following procedure to create a 3D workspace.

- 1** Add a Omron robot in the EtherCAT Configuration Tab Page. Refer to 4-2-1 *Creating a New Project* on page 4-4 for details.
- 2** Add 3D Shape Data such as box, cylinder, and imported CAD shape, if necessary.



### Additional Information

Boxes, cylinders, and imported CAD data are registered to Application Manager. Refer to *Sysmac Studio 3D Simulation Function Operation Manual (Cat. No. W618)* for details.





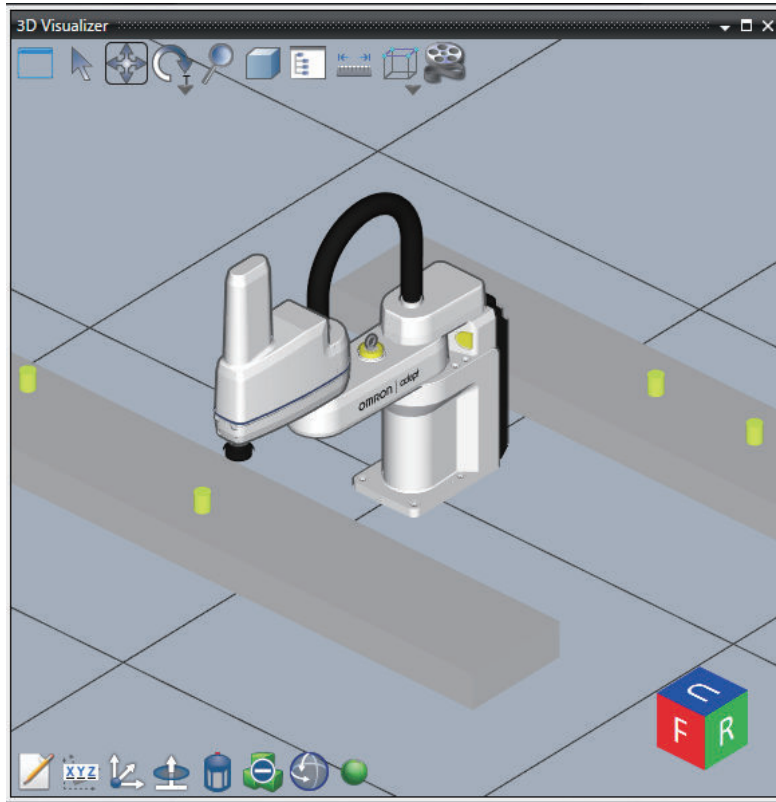







### 7-2-3 Description of Icons

Use the main toolbar icon, or select 3D Visualizer from the **View** menu, to access the **3D Visualizer**. The 3D Visualizer has the following control icons.



The icons displayed at the lower left of the 3D Visualizer are associated with the objects that you selected in the 3D Visualizer. If no object is selected, these icons are not displayed. Some icons are associated with specific objects as described in the following table.

Icon	Name	Description
	Split Window	Splits the 3D Visualizer. Refer to <i>Split Window</i> on page 7-7 for details.
	Selection	Selects the 3D shape data to edit.
	Translate	Translates the point of view in the 3D Visualizer. Click this icon or press the W key, press and hold the left mouse button, and then drag the mouse in the direction to translate.
	Rotate	Rotates the point of view in the 3D Visualizer. Click this icon or press the E key. Refer to <i>Rotate</i> on page 7-7 for details.
	Zoom	Zooms in or out the 3D Visualizer. Click this icon or press the R key, press and hold the left mouse button, and then drag the mouse.
	Projection Mode	Changes the projection modes in the 3D Visualizer: parallel projection or perspective projection. Refer to <i>Projection Mode</i> on page 7-7 for details.
	Scene Graph	Opens the Scene Graph dialog box to configure the visibility and collision detection settings for 3D shape data. Refer to <i>Scene Graph</i> on page 7-8 for details.

Icon	Name	Description
	Measurement Ruler	Measures the distance between 3D shape data in the 3D Visualizer. Click this icon to display a ruler. Select the ruler and then use the <b>Select point 1</b> and <b>Select point 2</b> icons to adjust the ruler position. At the lower left of the 3D Visualizer, distance information is displayed for the coordinate components X, Y, Z. It is the easiest to place the ruler based on the camera angle that is set in alignment with the global coordinate plane.
	Snap	Moves 3D shape data, or a mount point or link point of 3D shape data, to a specified point. Refer to <i>Snap</i> on page 7-10 for details.
	Record	Captures a simulation executed in the 3D Visualizer on video. Refer to <i>Record</i> on page 7-12 for details.
	Edit	Displays the settings for the selected 3D shape data.
	Direct Position Edit	Changes the position and orientation of the selected 3D shape data. Refer to <i>Direct Position Edit</i> on page 7-14 for details.
	Edit Work-space Position	Moves the position of the selected 3D shape data. This coordinate icon is displayed to allow you to assign the X, Y, and Z positions of the selected 3D data. If you place the cursor over an axis on the coordinate icon, the cursor shape changes. Left-click 3D shape data and drag it to a new position. If you place the cursor over the white circle on the coordinate icon, you can move 3D shape data freely by left-clicking and dragging it. The new position is reflected in the <b>Offset From Parent</b> value for the 3D shape data.
	Edit Work-space Orientation	Changes the orientation of the selected 3D shape data. This coordinate icon is displayed to allow you to manipulate the roll angle of objects. If you place the cursor over a roll axis (green ring), the cursor shape changes. Left-click an object and rotate it to a new roll angle. If you place the cursor over an axis on the coordinate icon after you set a new roll direction, the cursor shape changes. Left-click an object and drag it to a new position. If you place the cursor over the white circle on the coordinate icon, you can move objects freely by left-clicking and dragging them. The new position is reflected in the <b>Offset From Parent</b> value for the object. This icon is displayed only when a robot is selected.
	Jog Mode	Controls the jogging of robots in the 3D Visualizer. This icon is displayed only when a robot is selected. Refer to <i>Jog Mode</i> on page 7-16 for details.
	Show Obstacles	Shows or hides obstacles. Refer to <i>Obstacles</i> on page 5-29 for more information. This icon is displayed only when a robot is selected.
	Show Robot Work Envelope	Shows or hides the work envelope of the selected robot. The displayed work envelope is applied to the tool flange of the robot without consideration of the applicable Tip Offset. This icon is displayed only when a robot is selected.
	Teach Point	Adds the current position of the robot to the V+ Variables for RobotControlSettings as a new position variable. This icon is displayed only when a robot is selected.
	Show/Hide Mount Points	Shows or hides mount points. Refer to the <i>Sysmac Studio 3D Simulation Function Operation Manual (Cat. No. W618)</i> for details on operating procedure.



Icon	Name	Description
	3D View Switching Tool	Switches the display direction of 3D shape data in the 3D Visualizer. Refer to <i>3D View Switching Tool</i> on page 7-18 for details.





## Split Window

Use this icon to split the 3D Visualizer.

Click the icon to open the following window. To close the window, click **X**.



The functions of icons that you can select in the window are as follows.

Icon	Name	Function
	Not split	Does not split the 3D Visualizer.
	Split into two (Vertical)	Splits the 3D Visualizer vertically into two sections.
	Split into two (Horizontal)	Splits the 3D Visualizer horizontally into two sections.
	Split into four	Splits the 3D Visualizer into four sections.

## Rotate

Use this icon to rotate the point of view in the 3D Visualizer.



Press and hold the left mouse button, and then drag the mouse in the direction to rotate.

There are two rotation modes as follows.

Mode	Description
Tumbler rotation	3D shape data can be viewed from any angle.
Turntable rotation	The point of view can be rotated clockwise or counterclockwise around the Z axis of the world coordinate system. 3D shape data can be viewed in the range of $\pm 90^\circ$ vertically.

## Projection Mode

Use this icon to change the projection mode in the 3D Visualizer between parallel projection and perspective projection.

Icon	Name	Description
	Parallel projection	In this projection mode, the projection lines are connected in parallel between every point on the object and the point of view. It has a characteristic that an object is displayed in its true size regardless of the distance from the viewer. This projection method is suitable when you compare the sizes of objects that are placed.
	Perspective projection	A method of projecting an object based on the law of perspective. It has a characteristic that farther away an object from the viewer, smaller it appears, and closer the object to the viewer, larger it appears. This projection method is suitable when you display objects approximately in their size in the real world.

## Scene Graph

Use this icon to configure the visibility and collision detection settings for 3D shape data.

The setting items are as follows.

### ● Visibility Tab Page

In the list displayed on the tab page, set whether to show or hide the tiles, ruler, and 3D shape data in the 3D Visualizer.

To display an item, select the corresponding check box.

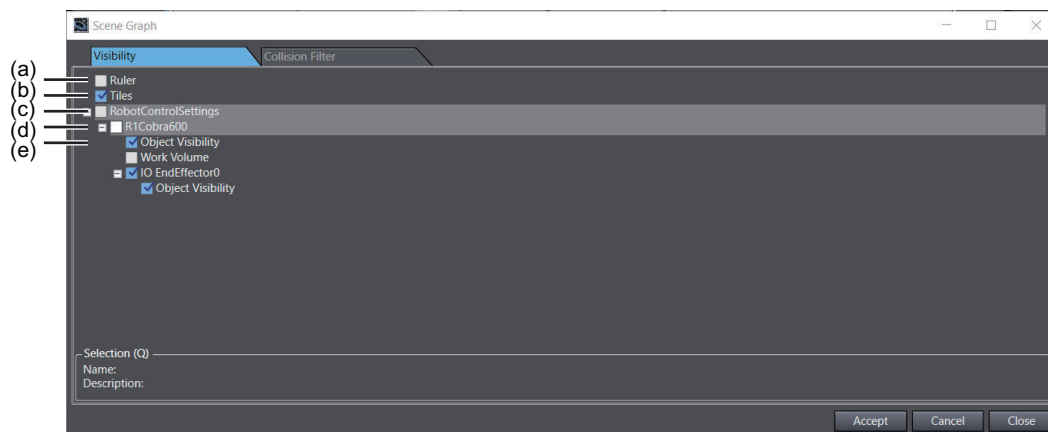

	Item	Description	Set value	Initial value
(a)	Tiles	Select whether to display the XY plane with a 1,000-mm mesh when Z=0 in the 3D Visualizer.	Checked or unchecked	Checked
(b)	Ruler	Select whether to display a ruler when you measure the distance between 3D shape data in the 3D Visualizer. This is the same as the function of the Measurement Ruler icon.	Checked or unchecked	Unchecked
(c)	Devices	Select whether to show or hide in the 3D Visualizer the 3D shape data registered in the project by device.	Checked or unchecked	Checked
(d)	3D shape data	Select whether to show or hide in the 3D Visualizer the 3D shape data registered in the project by 3D shape data.	Checked or unchecked	Checked
(e)	Object Visibility			

## ● Collision Filter Tab Page

The Collision Filter tab is displayed only in the 3D Visualizer.

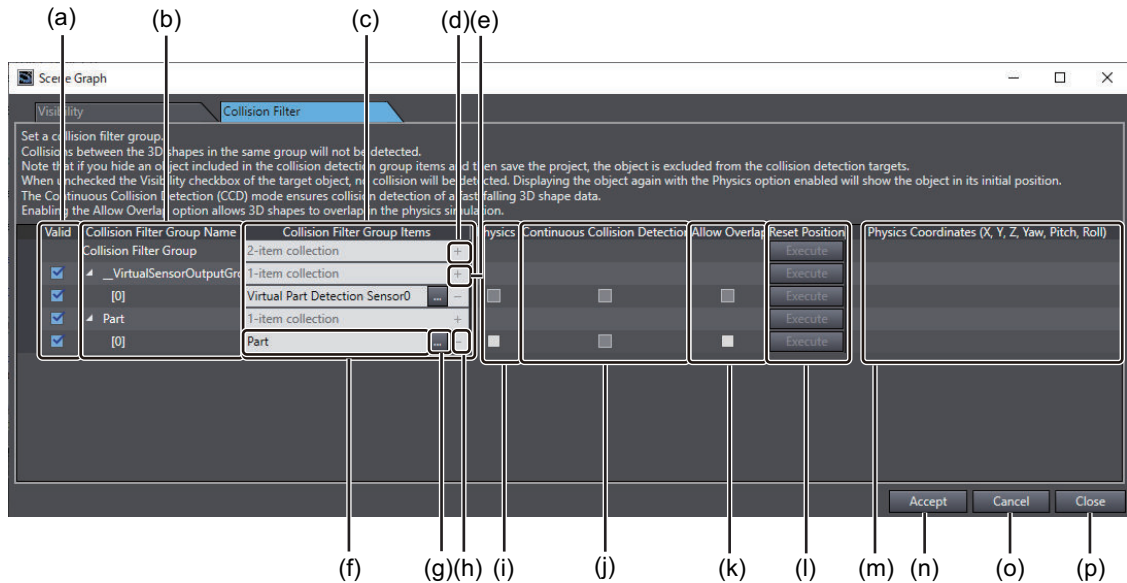

	Item	Description	Set value	Initial value
(a)	Valid check box	Select whether to enable the item in each collision filter group as a collision detection target. Select the check box to enable the item as a collision detection target.	Checked or unchecked	Checked
(b)	Collision Filter Group Name list	Manage the items in the Collision Filter Group list. The text box displays <i>*-itemcollection</i> ( <i>* is the collision filter group number</i> ). Click the <b>Add Collision Filter Group</b> button to add a collision filter group. The group name to be added is <i>Group*</i> ( <i>* is the number of collision filter groups</i> ).	Text string	0-item collection (No collision filter group in the initial status)
(c)	Collision Filter Group Items list	Manage the items in the Collision Filter Group Items list. <i>*-itemcollection</i> ( <i>* is the number of collision filter group items</i> ) is displayed in the list. Click the <b>Add Collision Filter Group Items</b> button to add a collision filter group item.	Text string	0-item collection (No collision filter group item in the initial status)
(d)	Add Collision Filter Group button	Adds a collision filter group. Clicking this button adds a collision filter group to the list.	---	---
(e)	Add Collision Filter Group Item button	Adds a collision filter group item. Clicking this button adds a collision filter group item setting row to the list.	---	---
(f)	Collision Filter Group Item name	Set the target to add to the collision filter group. Refer to 7-2-4 <i>Collision Detection Settings</i> on page 7-19 for the targets that you can set.	Text string	---
(g)	Collision Filter Group Item Selection button	Displays a dialog box in which you can select the target to add to the collision filter group.	---	---
(h)	Delete Collision Filter Group Item button	Deletes a collision filter group item from the collision filter group. Clicking this button deletes the item.	---	---

	Item	Description	Set value	Initial value
(i)	Physics	Selecting this check box and clicking the <b>Accept</b> button enables the physics simulation of the target 3D shape data. This allows you to check how the falling 3D shape data collides with other 3D shape data and how the movable parts of custom mechanics move.	Checked or unchecked	Unchecked
(j)	Continuous Collision Detection	Enabling Continuous Collision Detection (CCD) makes it possible to certainly detect the collision of 3D shape data falling at high speed. Enabling this function makes sure of detection of collisions but affects the drawing performance of 3D Visualizer.	Checked or unchecked	Unchecked
(k)	Allow Overlap	Enabling Allow Overlap allows the target 3D shape data of physics simulation to overlap with each other.	Checked or unchecked	Unchecked
(l)	Reset Position	Resets the target 3D shape data of physics simulation to the original position. When the <b>Physics</b> check box is selected, the target 3D shape data falls from the original position or the movable parts of a custom mechanics move from the original position each time you click the <b>Execute</b> button.	---	---
(m)	Physics Coordinates (X, Y, Z, Yaw, Pitch, Roll)	Displays the coordinate values of the 3D shape data during physics simulation.	---	---
(n)	<b>Accept</b> button	Accepts the changes.	---	---
(o)	<b>Cancel</b> button	Cancels the changes and then, closes the Scene Graph dialog box.	---	---
(p)	<b>Close</b> button	Closes the Scene Graph dialog box.	---	---

Refer to *7-2-4 Collision Detection Settings* on page 7-19 for details on how to configure the collision detection settings.

## Snap

Use this icon to set an offset for a mount point or a link point of 3D shape data.

- 1 Select the target 3D shape data, and then click the **Snap** icon or press the T key.



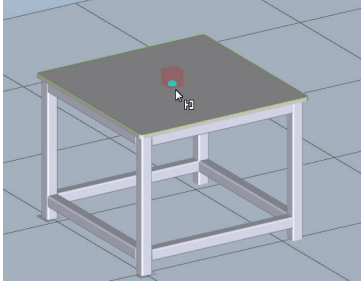

- 2 Move the cursor to where you want to snap it to display candidate points of the snap destination. Click one of the candidate points to snap it to that position.



To change the mode of snapping, click the icon and select its function in the following window. Or, press the T + number keys. To close the window, click X.



The functions of icons that you can select in the window are as follows.

Icon	Name	Function	Shortcut keys
	Snap to Edge	Moving the cursor near a mount point or link point that is set in the 3D shape data displays a preview of the snap position. Either both ends or the center of the highlighted edge is emphasized, and the mount point or the link point can be snapped to the position.	T + 1
	Snap to Face	Moving the cursor near a mount point or link point that is set in the 3D shape data displays a preview of the snap position. The center of gravity of the highlighted face is emphasized, and the mount point or the link point can be snapped to the position.	T + 2
	Snap to Link	Moving the cursor near a mount point that is set in the 3D shape data displays a preview of the snap position. Any link point that is present on the highlighted face is displayed, and the mount point can be snapped to the position.	T + 5

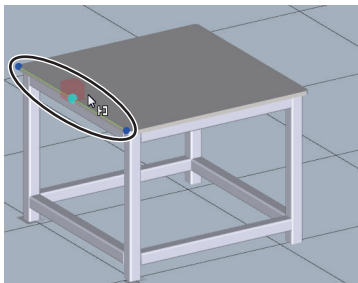

Snap to Edge

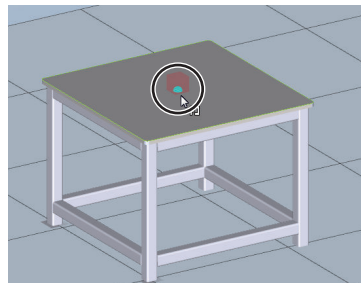

Snap to Face

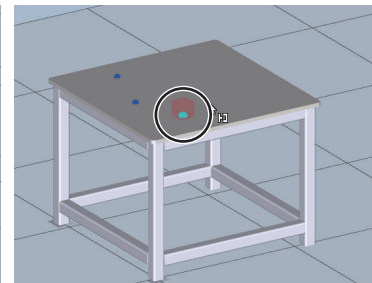

Snap to Link



### Additional Information

---

- A preview of the snap position will be displayed for the following objects.
    - a) Box
    - b) Cylinder
    - c) CAD data
    - d) Mechanical component
    - e) Custom mechanics
    - f) Parallel link model
 When an end-effector mounted on a robot is snapped, a preview of the above objects a) to f) that have the end-effector set as the parent will be displayed.
  - You can change the highlight color of the snap position. Change it in the option settings. Refer to *A-1 Option Settings* on page A-2 for details.
- 

## Record

---

Use this icon to capture a simulation executed in the 3D Visualizer on video.

### ● Recording Video

- 1** Click the **Record** icon during the execution of a 3D simulation.



The icon changes and starts flashing. This indicates that video recording is in progress.



- 2** To stop the recording, click the **Record** icon.  
The **Save As** dialog box is displayed.

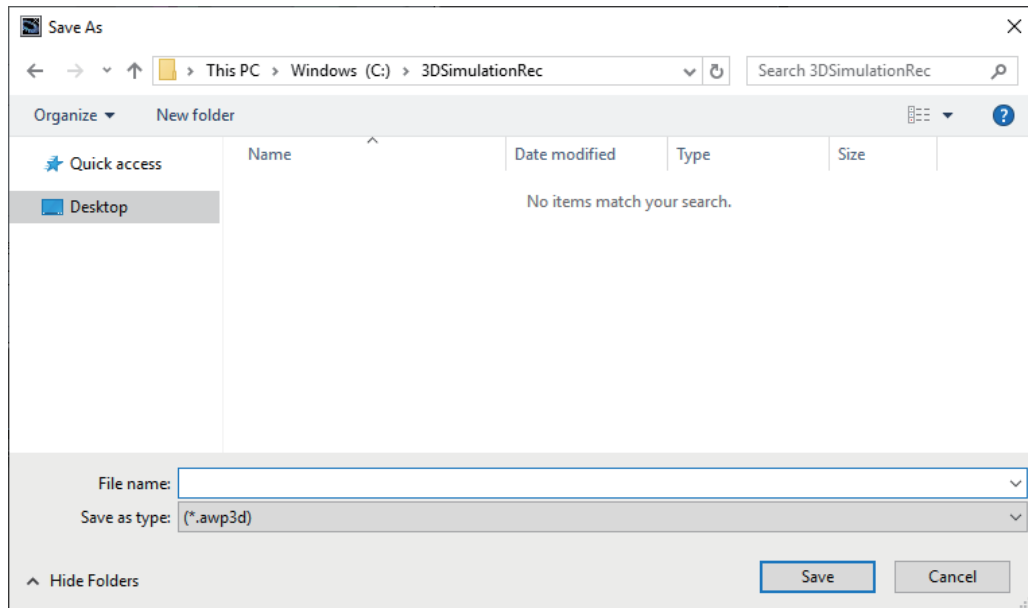

- 3 Enter the file name, and then click the **Save** button.  
The video is saved to a file.

### ● Playing Back Video

Use the Offline Visualizer to play back video.

- 1 Select **All Programs - OMRON - Sysmac Studio - Tools - Offline Visualizer** from the Windows Start menu.  
The **Offline Visualizer** starts.

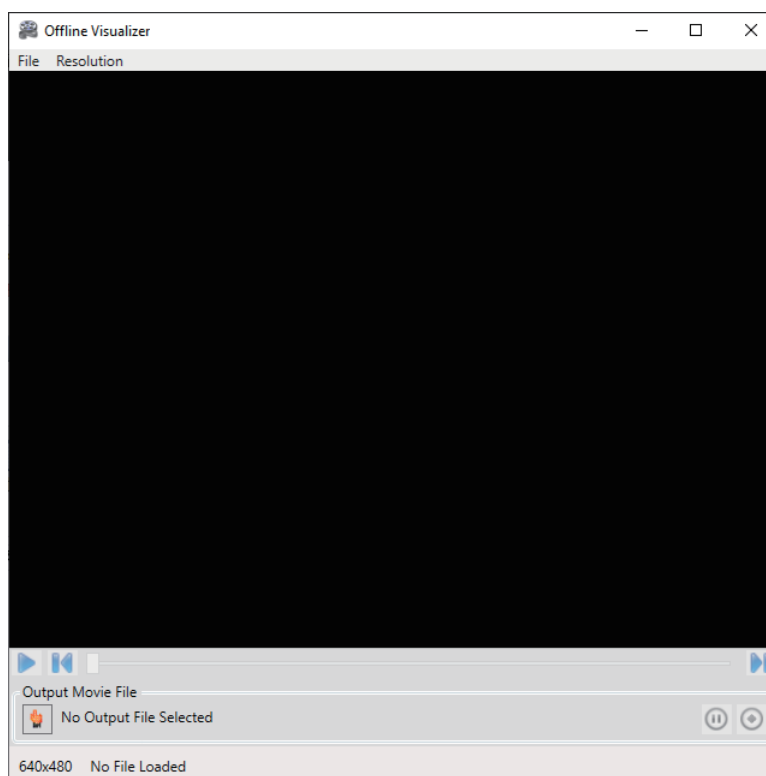

- 2 Select **Open** from the **File** menu.  
The **Open** dialog box is displayed.
- 3 Select the record file (with a .awp3d extension) to play back and then click the **Open** button.  
The selected record file is opened.

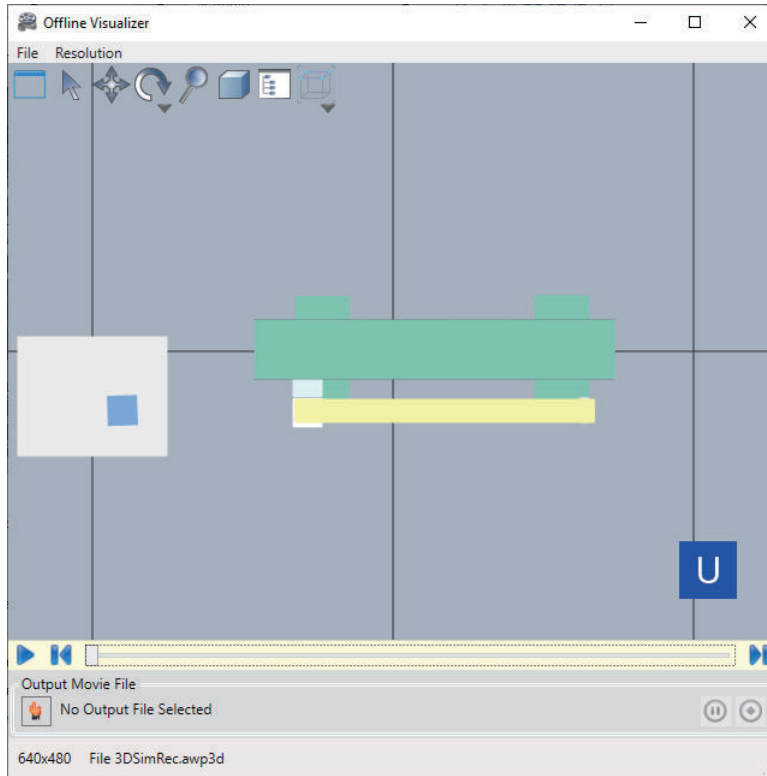

- 4 Click the **Play** button.  
The video is played back.

## Direct Position Edit

The 3D Visualizer allows you to edit 3D shape data by directly entering values while you are checking the positional relationship between the 3D shape data.

- 1 In the 3D Visualizer, select the 3D shape data to edit with the mouse cursor.  
The **Direct Position Edit** icon is displayed in the 3D Visualizer.



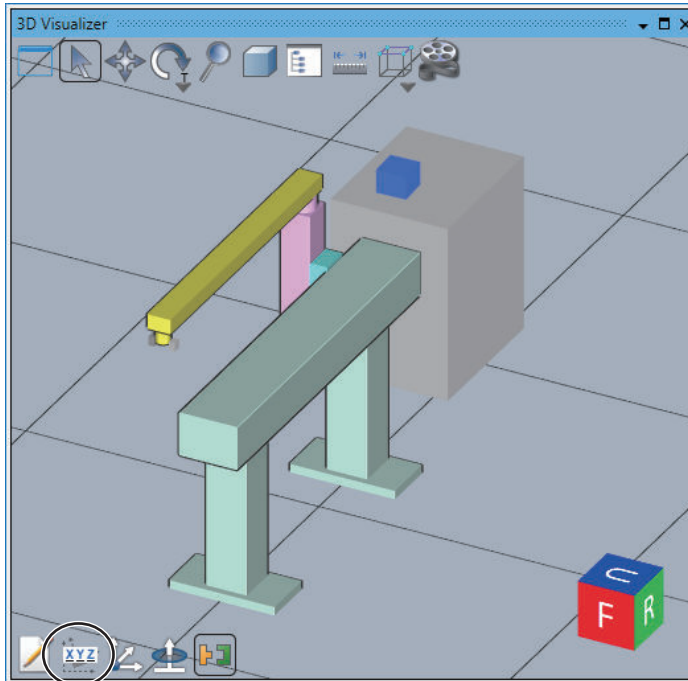



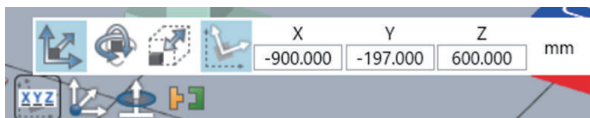

- 2** Click the **Direct Position Edit** icon.  
The value input fields for the 3D shape data are displayed in the 3D Visualizer.



- 3** Select an icon in the **Direct Position Edit** to enable the value input fields for the 3D shape data.

Icon	Name	Function								
	Edit Work-space Position	Enter X, Y, and Z values that specify the position of the 3D shape data. <div style="text-align: center;"> <table border="1" style="margin: auto;"> <tr> <td>X</td> <td>Y</td> <td>Z</td> <td>mm</td> </tr> <tr> <td>-900.000</td> <td>-197.000</td> <td>600.000</td> <td></td> </tr> </table> </div>	X	Y	Z	mm	-900.000	-197.000	600.000	
X	Y	Z	mm							
-900.000	-197.000	600.000								
	Edit Work-space Orientation	Enter Yaw, Pitch, and Roll values that specify the orientation of the 3D shape data. <div style="text-align: center;"> <table border="1" style="margin: auto;"> <tr> <td>Yaw</td> <td>Pitch</td> <td>Roll</td> <td>degree</td> </tr> <tr> <td>0.000</td> <td>0.000</td> <td>1.944</td> <td></td> </tr> </table> </div>	Yaw	Pitch	Roll	degree	0.000	0.000	1.944	
Yaw	Pitch	Roll	degree							
0.000	0.000	1.944								

Icon	Name	Function																								
	Edit Size	<p>Enter a value that specifies the size of the 3D shape data. The values that you can enter change depending on the 3D shape data.</p> <p><b>Box</b></p> <table border="1"> <tr> <td>DX</td> <td>DY</td> <td>DZ</td> <td>mm</td> </tr> <tr> <td>100.000</td> <td>100.000</td> <td>80.000</td> <td></td> </tr> </table> <p><b>Cylinder</b></p> <table border="1"> <tr> <td>Radius</td> <td>Height</td> <td>mm</td> </tr> <tr> <td>100.000</td> <td>100.000</td> <td></td> </tr> </table> <p><b>Virtual Part Detection Sensor</b></p> <table border="1"> <tr> <td>Length</td> <td>mm</td> </tr> <tr> <td>250.000</td> <td></td> </tr> </table> <p><b>Belt</b></p> <table border="1"> <tr> <td>Width</td> <td>Length</td> <td>mm</td> </tr> <tr> <td>250.000</td> <td>3000.000</td> <td></td> </tr> </table>	DX	DY	DZ	mm	100.000	100.000	80.000		Radius	Height	mm	100.000	100.000		Length	mm	250.000		Width	Length	mm	250.000	3000.000	
DX	DY	DZ	mm																							
100.000	100.000	80.000																								
Radius	Height	mm																								
100.000	100.000																									
Length	mm																									
250.000																										
Width	Length	mm																								
250.000	3000.000																									
	Local Coordinate System	<p>Select the coordinate system used for <b>Edit Workspace Position</b> or <b>Edit Workspace Orientation</b>. The coordinate system toggles every time you click. The initial setting is the local coordinate system.</p>																								
	World Coordinate System																									

## Jog Mode



Use this icon to control the jogging of robots in the 3D Visualizer.

Clicking this icon displays Jog icons at the left of the 3D Visualizer. Use the Jog icons to manually control the position of the selected robot. The Jog Mode cycles through World, Tool, and Joint every time you click this icon.

Icon	Mode
	World
	Tool
	Joint

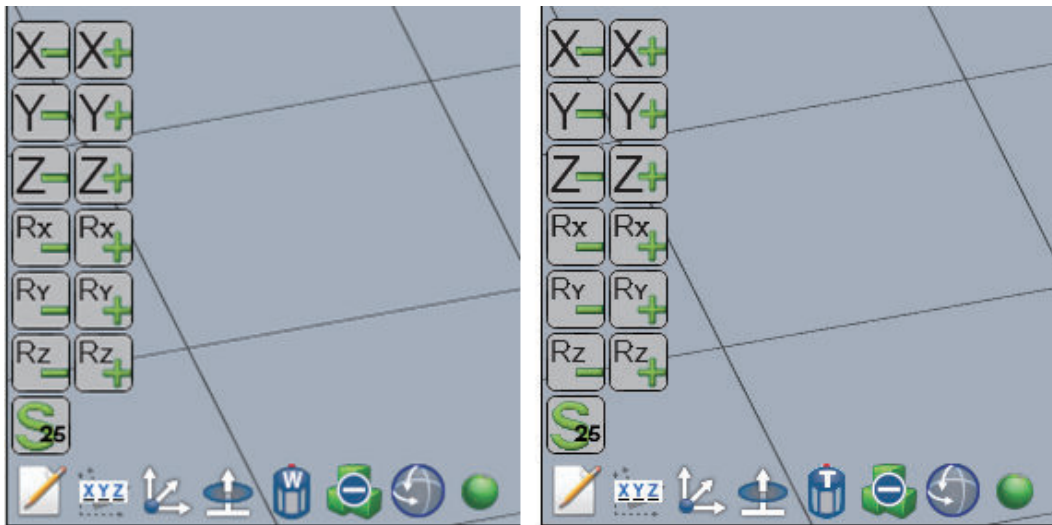

### ● Jog Mode: World or Tool

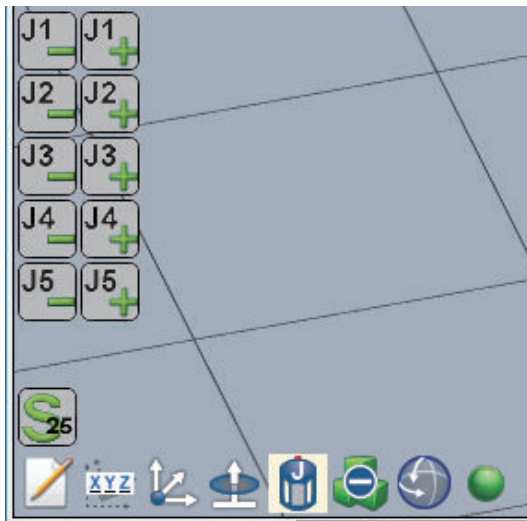

Icon	Name	Description
	Jog icons for axial travel	Click one of these buttons repeatedly to move the robot along the X, Y, or Z axis in the positive or negative direction.
	Jog icons for axial rotation	Click one of these buttons repeatedly to rotate the robot around the X, Y, or Z axis in the positive or negative direction.
	Jog Speed	The Jog Speed cycles through 100%, 50%, 25%, and 5% every time you click the icon.

### ● Jog Mode: Joint





Icons	Name	Description
	Jog icons for Joint axial rotation	Click one of these buttons repeatedly to rotate each joint of the robot in the positive or negative direction.
	Jog Speed	The Jog Speed cycles through 100%, 50%, 25%, and 5% every time you click the icon.

## 3D View Switching Tool

Use this icon to switch the display direction of 3D shape data in the 3D Visualizer.

The 3D View Switching Tool is made up of three elements, i.e., Face, Corner, and Edge. Place the mouse cursor over an element and, when it turns black, click it. Then, the view is switched so that the portion that you clicked is the front face. Accordingly, the display direction of 3D shape data in the 3D Visualizer is switched.

Configura- tion element	Name	Description	Shortcut keys
	Face	Represents a face. A face is indicated with one of the following symbols.	---
		F (Front): The front face when 3D shape data faces the yz plane	Ctrl + 1
		B (Back): The face parallel to the F face	Ctrl + 2
		U (Up): The upper orthogonal face to the F face	Ctrl + 3
		D (Down): The lower orthogonal face to the F face	Ctrl + 4
		L (Left): The left side face to the F face	Ctrl + 5
	R (Right): The right side face to the F face	Ctrl + 6	
	Corner	Represents a corner.	---
	Edge	Represents an edge.	Ctrl + 7 (The edge between Up and Front)



#### Additional Information

To reset the scale and display position of 3D visualization to the initial status, place the mouse cursor in the 3D Visualizer, and then press the Ctrl + 8 keys.

## 7-2-4 Collision Detection Settings

The 3D Visualizer can be configured to detect collisions between objects. When a collision is detected in the 3D Visualizer, any C# Collision program(s) that are associated with the objects in the collision are called.

This is typically used while testing an application with the 3D Visualizer in Emulation Mode and will not prevent physical hardware collisions.



#### Precautions for Correct Use

Collision Detection differs from obstacles configured in Robot Settings. Refer to *Obstacles* on page 5-29 for the information on obstacles.

### Configuring Collisions in the 3D Visualizer

Use the Scene Graph icon in the 3D Visualizer to configure collisions. **Scene Graph** dialog box is opened. Refer to *Scene Graph* on page 7-8 for details of items displayed.









Click the Collision Filter tab to register an object you want to detect its collision to the different Collision Group. Refer to *Sysmac Studio 3D Simulation Function Operation Manual (Cat. No. W618)* for details.

## 7-3 V+ Jog Control

This section describes how to operate the robot in the JOG mode through Sysmac Studio.

V+ Jog Control is a function used to determine the selected robot's position and monitor it. Generally, it is used to teach robots their positions.

You can see the robot's movements on the 3D Visualizer when using V+ Jog Control in the Emulation mode.

 <b>WARNING</b>	
Ensure the enough safety before making any changes that may affect the operation of the robot.	
 <b>WARNING</b>	
Make sure that there are no hazards caused by robot's movements before operating the robot using the V+ Jog Control function.	
 <b>WARNING</b>	
Take a particular attention to the robot speed setting when you operate the robot using the V+ Jog Control function. Get ready to bring the robot to an emergency stop at an emergency. Make sure that there are no hazards caused by robot's movements before operating the robot.	
 <b>WARNING</b>	
Confirm that you are operating the right robot before conducting a jog operation using V+ Jog Control function.	



### Additional Information

V+ Jog Control is effective on both the robot in the Emulation mode and the actual robot. Most of jog commands and settings are disabled when the robot is controlled by Program Control. Refer to *Current Position Section* on page 7-23 for details.

### 7-3-1 Starting V+ Jog Control

- 1 Select *RobotControlSettings* from the device list in the Multiview Explorer or *Application Manager*, and click **View – V+ Jog Control** in the main menu.

View	Insert	Controller	Tools	Window	Help
Multiview Explorer					Alt+1
Project Shortcut View					Alt+Shift+1
Toolbox					Alt+2
3D Visualizer					Alt+Shift+2
Output Tab Page					Alt+3
Watch Tab Page					Alt+4
Watch Tab Page(Table)					Alt+Shift+4
Cross Reference Tab Page					Alt+5
Build Tab Page					Alt+6
Event Log					
Search and Replace Results Tab Page					Alt+7
Simulation Pane					Alt+8
Differential Monitor					Alt+9
Smart Project Search					Ctrl+Shift+F
Recently Closed Windows					Ctrl+Shift+H
Clear Recently Closed Windows History					
V+ Jog Control					Alt+Shift+J

V+ Jog Control Pane is displayed.

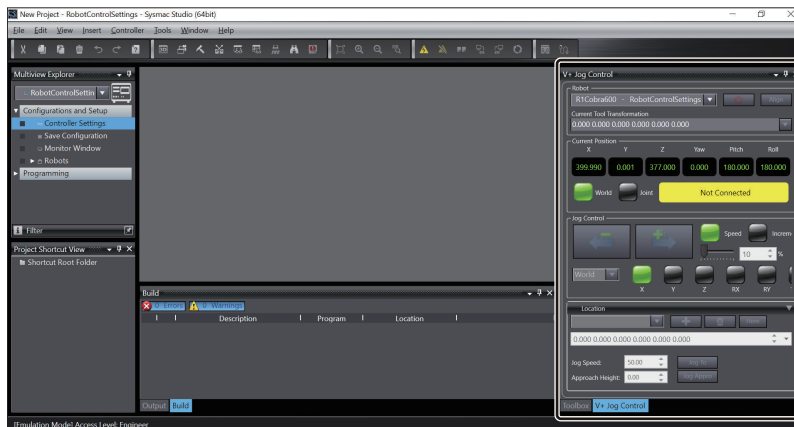

## 7-3-2 V+ Jog Control Setting Items

The following section describes items to be set for V+ Jog Control.



## Robot Section

The Robot section provides the following functions.

### ● Robot

Select a robot to control with the V+ Jog Control. You can access to all robots in the project from the drop-down.

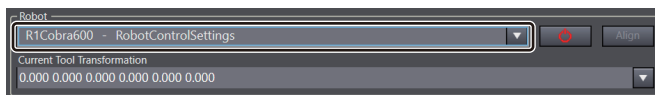

### ● Robot Power

The **Power** button toggles the robot high power ON and OFF and calibrates the selected robot. If gone online with the Robot Integrated CPU Unit, pressing the **Power** button has the Robot High Power button connected to a robot blinking for the period that set in the Safety Timeout. The power will be provided to the robot ready for operation if the Robot High Power button is pressed during this period.

Robot power must be ON to allow jog control.



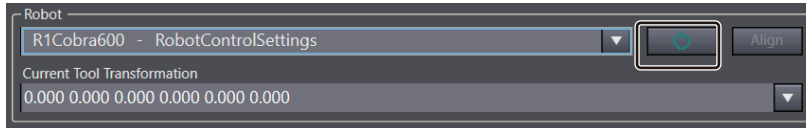

### Additional Information

- Refer to *Configure Robots Safety Timeout* on page 5-17 for how to configure Robot Safety Timeout.
- Turning the robot high power ON for the first time after system power up executes the CALIBRATE() function to load joint calibration offsets into memory. It does not mean that a full robot hardware calibration will be performed.

### ● Align

The **Align** button aligns the robot tool Z-axis with the nearest World axis (six-axis robots only).

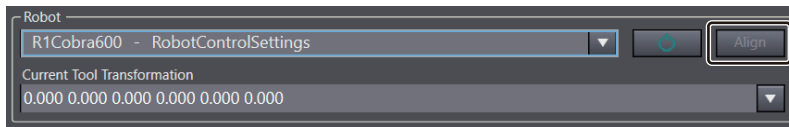

### ● Current Tool Transformation

The current tool transformation applied to the robot is displayed. The dropdown can be used to clear the tool transformation or select a tool transformation provided by an IO EndEffector tip.

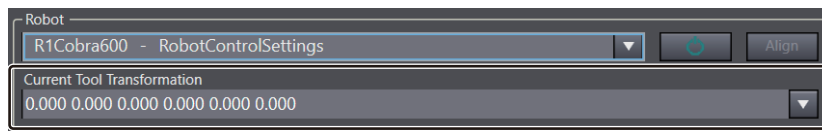

### ● Current Position Section

This section displays the status and current position of the robot in world or joint coordinates. Click the **World** button to display coordinates in world mode. Click the **Joint** button to display coordinates in joint mode.

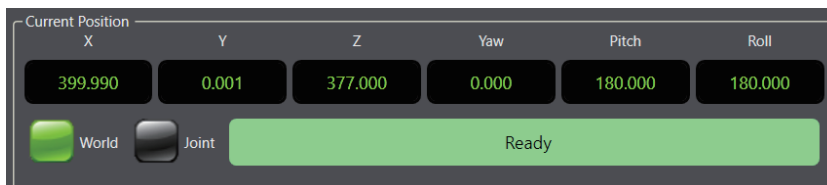

### Additional Information

Jogging is only possible when **Ready** is displayed in the status area. If a robot is under program control, *Robot under program control* will be displayed in this area and jogging is not possible. The task controlling the robot must be stopped before jogging functions are enabled.

## Jog Control Section

You can manually position a robot in the Jog Control section.

### ● Move Axis Buttons

After all jog control settings are made, use the move axis buttons to move the selected axis in the positive or negative direction.



### ● Speed/Increment Selection Buttons

Jogging is possible at a preset speed or in incremental distances, to allow greater positioning precision.

When the **Speed** button is active, use the slider or input a value between 0 and 100% to set the jog speed when a move axis button is pressed.

When the **Increment** button is active, use the slider or input a value between 0 and 10 mm to set the movement distance when a move axis button is pressed.



### ● World, Joint, Tool Selection

Select world, joint or tool for the JOG CONTROL mode.



Coordinate Type	Description
World	Enables the jog control to move the robot in the selected direction: X, Y, or Z axes of the world frame of reference or rotated around the RX, RY, or theta axes in the world coordinate system.
Joint	Enables the jog control to move the selected robot joint.
Tool	Enables the jog control to move the robot in the selected direction: X, Y, or Z axes of the tool frame of reference or rotated around the RX, RY, or theta axes in the tool coordinate system.



### Precautions for Correct Use

Positive direction of the selected axis may differ depending on the coordinate type. Check the positive direction of the axis before performing an operation. When you have changed the coordinate type and clicked the Move Axis button, the robot may move to a direction different from the direction before changed coordinate type.

## Location Section

The Location section is used to view, teach, remove, and jog to robot locations. Refer to *V+ Variable Type* on page 6-4 for more information.

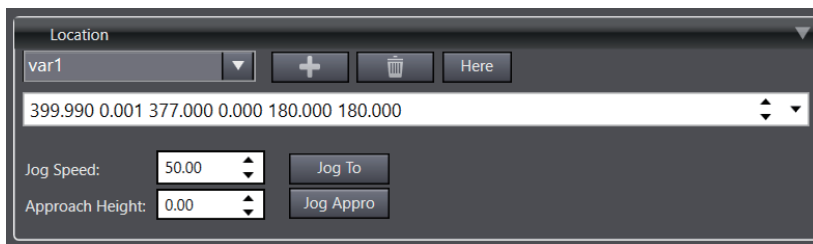

### ● Jog to a Robot Location

Implement the following procedure to jog to a robot location.

- 1 Select a location with the drop-down menu.
- 2 Select values for the **Jog Speed** and **Approach Height** fields.
- 3 Click and hold the **Jog To** button to make the robot jog to the specified location.
- 4 Click and hold the **Jog Appro** button to make the robot jog to the specified location at the approach height specified.



### Precautions for Correct Use

- A robot location must exist and be selected to use this function.
- Using the **Jog Appro** button will cause straight-line motion to occur. Monitor the robot during this movement to avoid collisions with obstacles between the starting location and the destination location.

### ● Teach Robot Locations

Before teaching a location, move the robot to the desired location (either by jogging or powering OFF and physically moving the robot) and then, click the **Here** button.

Clicking the **Here** button will put the robot's current axis positions into the display field for use in the following teach procedure.

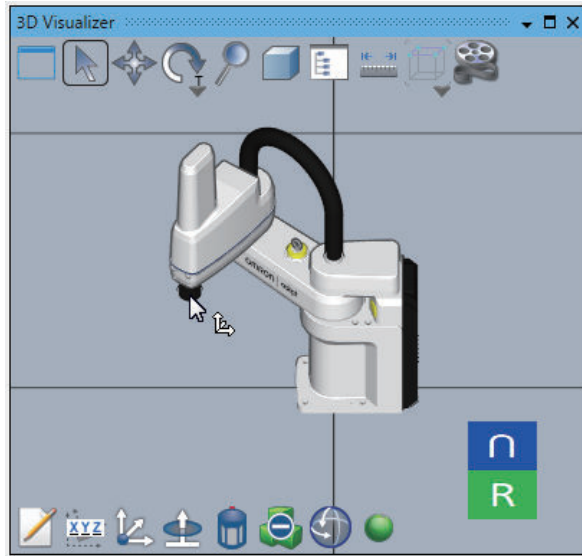

### Additional Information

In the EMULATION mode, you can change the robot tool tip position in the 3D Visualizer with the mouse cursor. Hover over the tool tip until the mouse pointer changes, and then, left-click and drag to the new position.

Refer to *7-7-2 Teaching on 3D Visualizer* on page 7-43 for details.

Refer to *V+ Variable Editor* on page 6-5 for other robot position teach functions.

- 1 Click the **+** button. The **Add a new variable** dialog box appears.

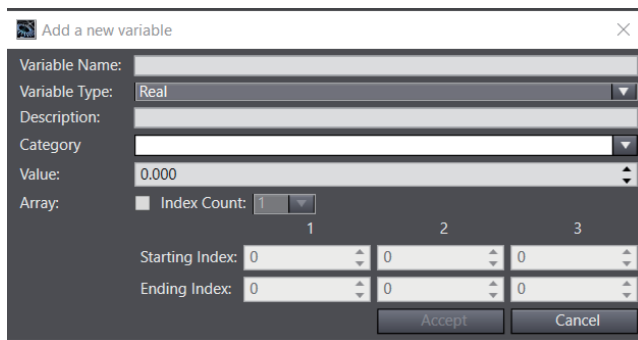

- 2 Select a variable type (location or precision point), provide a new name, and verify the value. If you change a selection from the robot drop-down, click the **Record** button to update the value for that robot accordingly.
- 3 Select a display mode, category, and provide a description, if necessary.
- 4 Select values for Array, Starting and Ending Index, if necessary.
- 5 Click the **Accept** button to create the new robot location variable.

- **Remove Robot Locations**

To remove an existing robot location, select the location from the drop-down menu and then click the **Delete** button. A confirmation dialog box is displayed. Click **Yes** to remove the robot location variable.

## 7-4 Task Status Control

The Task Status Control provides a multi-device monitoring interface for all robot related activity in the project.

This allows you to quickly view and access all controller connection and power statuses, and monitor speeds.

All controllers in the project are shown in the Task Status Control Interface.

### 7-4-1 Starting Task Status Control

- 1 Select *RobotControlSettings* from the device list in the Multiview Explorer or *Application Manager*, and click *View – Task Status Control* in the main menu.

View	Insert	Controller	Tools	Window	Help
Multiview Explorer					Alt+1
Project Shortcut View					Alt+Shift+1
Toolbox					Alt+2
3D Visualizer					Alt+Shift+2
Output Tab Page					Alt+3
Watch Tab Page					Alt+4
Watch Tab Page(Table)					Alt+Shift+4
Cross Reference Tab Page					Alt+5
Build Tab Page					Alt+6
Event Log					
Search and Replace Results Tab Page					Alt+7
Simulation Pane					Alt+8
Differential Monitor					Alt+9
Smart Project Search					Ctrl+Shift+F
Recently Closed Windows					Ctrl+Shift+H
Clear Recently Closed Windows History					
V+ Jog Control					Alt+Shift+J
<b>Task Status Control</b>					<b>Alt+Shift+T</b>
Vision Window					Alt+Shift+V

*Task Status Control* Tab Page is displayed.

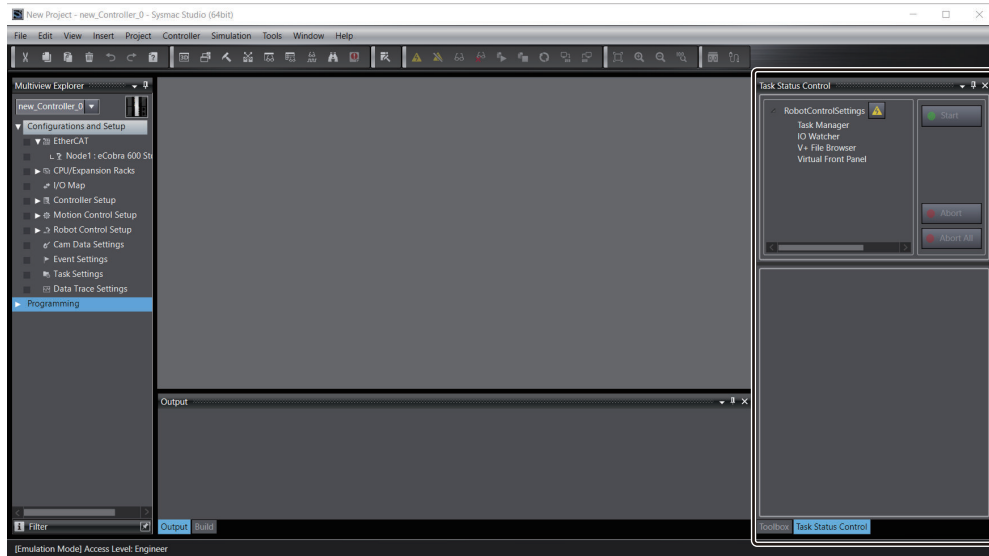

### 7-4-2 Displayed Items in Task Status Control



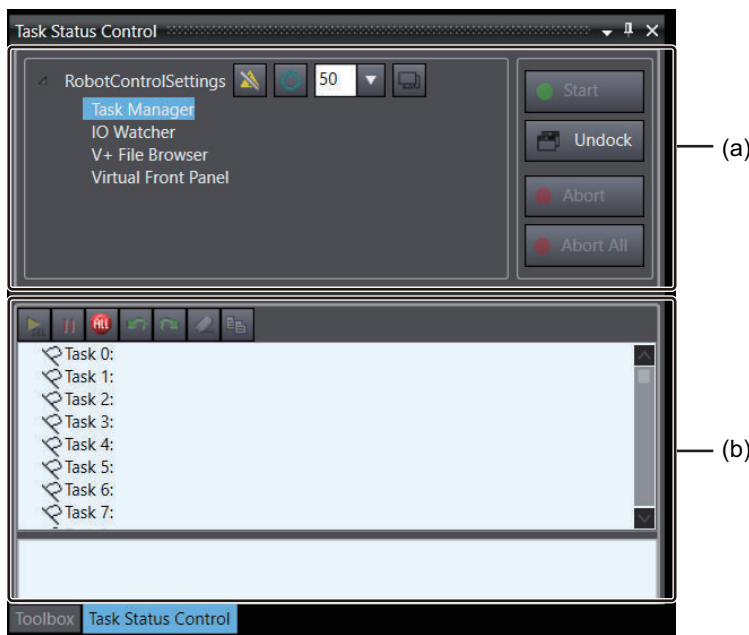



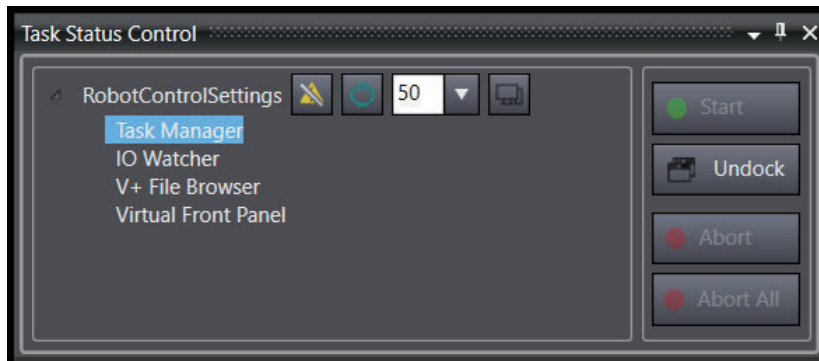

The following items are displayed in Task Status Control.

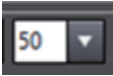

	Item	Descriptions
(a)	Item list area	Items controlled with Task Status Control Tab Page are displayed.
(b)	Description display area	Details on the Item selected in the item list area is displayed. Press the <b>Undock</b> button to show contents in this area in a different window.

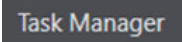
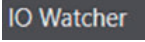
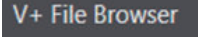
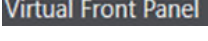
## Item List

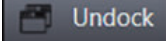
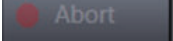

	Item	Description	Reference
	<b>Online</b> button	Control the connection status to the Robot Integrated CPU Unit.	-
	<b>Robot High Power</b> button	Toggle the robot power state This button is only available while online with the controller.	-
	Monitor speed setting drop-down	Configure robot's motion speed (min. 0, max. 100).	<i>Monitor Speed Setting</i> on page 7-31
	<b>Open the Monitor Window</b> button	Monitor Window Tab Page is displayed.	<i>Open the Monitor Window</i> on page 7-31
	Task Manager	Task Manager is displayed at the bottom	<i>7-4-4 Task Manager</i> on page 7-31
	IO Watcher	IO Watcher is displayed at the bottom.	<i>7-4-5 IO Watcher</i> on page 7-34
	V+ File Browser	V+ File Browser is displayed at the bottom.	<i>7-4-6 V+ File Browser</i> on page 7-34
	Virtual Front Panel	Virtual Front Panel is displayed at the bottom.	<i>7-4-7 Virtual Front Panel</i> on page 7-36
	Start	Execute the selected Application Manager function. Not available in systems that this manual deals.	-
	Undock	Show the currently displayed view in a different window.	-
	Abort	Abort the selected running Application Manager function. Not available in systems that this manual deals.	-
	Abort All	Abort all Application Manager functions. Not available in systems that this manual deals.	-



### 7-4-3 Robot Integrated CPU Unit Settings Items

You can establish a connection with the Robot Integrated CPU Unit or toggle ON and OFF of robot's high power.

#### Monitor Speed Setting

The monitor speed setting is used to adjust the monitor speed for the associated controller. It is a multi-robot speed scaling parameter for each controller that allows you to decrease the overall speed of the system without modifying programs. Generally, the setting is used while debugging programs.

#### Open the Monitor Window

The Monitor Window button opens the **Monitor Window** in the Edit Pane.  
Refer to 5-5-3 *Monitor Window* on page 5-22 for details.

### 7-4-4 Task Manager

The Task Manager displays and controls activities of user tasks 0 to 27. Robot Control Function Module in Robot Integrated CPU unit uses two tasks and one task per robot, counting down from 27. The remaining tasks (0 to 21, or more if fewer than four robots) are available for the execution of user-created V+ programs.



#### Additional Information

If a program is paused the task can be expanded to view the current program stack.

## WARNING

When building a robot system that includes this CPU Unit or an Omron robot, be sure to ensure compliance with the laws and regulations on the safety of industrial robots in the country or region where the robot is operating in design and operation of the system. Refer to *Robot Safety Guide (Cat. No. I590)* for details.





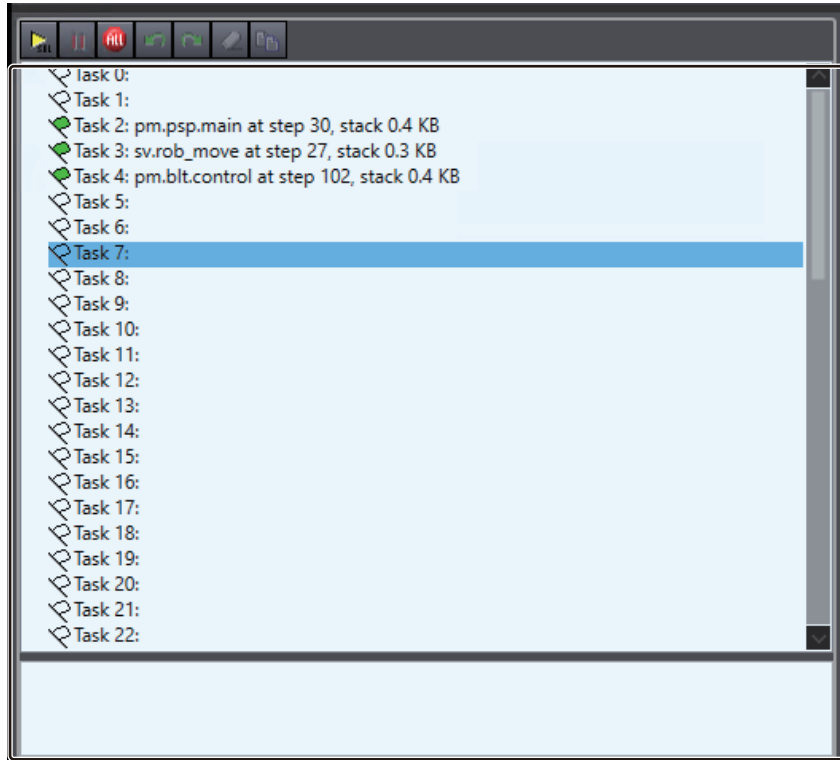





The following describes Task Manager controls.







## Task Manager Toolbar Items

The following functional icons are provided in the toolbar. You can select a function from the right-click menu of a task.

Icon	Item	Description
	Execute Task	If a stopped program is selected, this button will execute that program on the task.
		If a task is selected with no program, this button will open a dialog box for program selection. Selecting a program name and clicking <b>OK</b> will execute the program on the selected task.
	Pause Task	The selected task execution is paused at the next instruction.
	Stop All Tasks	Stops the execution of all running tasks.
	Retry Step	If the selected task was paused or stopped due to an error, this button attempts to re-execute the current step and continue execution.
	Proceed Task	If the selected task was paused or stopped due to an error, this button attempts to proceed execution of the task. This button is dimmed if there is no program for the given task or no task selected.
	Kill Task	Clears the selected task of any programs. AUTO variables or calling arguments cannot be changed while a program is in a task stack.
	Copy stack to windows clipboard	Copies the contents of the selected task stack to the Windows clipboard. If a program terminates with an error, this allows you to copy and paste the stack contents for troubleshooting. Robot IDs are also recorded in this operation.

The flag icon next to each task in the list area represents the task state.

Task Flag Icon	Description
	Task is idle or primed.
	Task is being executed.
	Task is paused or at a breakpoint. A program's task flag icon will turn yellow if you drag it onto a task to prime it.
	Task has an execution error or program execution was manually aborted.
	Task execution has completed.

## Other Functions

This section provides the information about other functions regarding to task execution. Right-click a task to select a function from the menu.

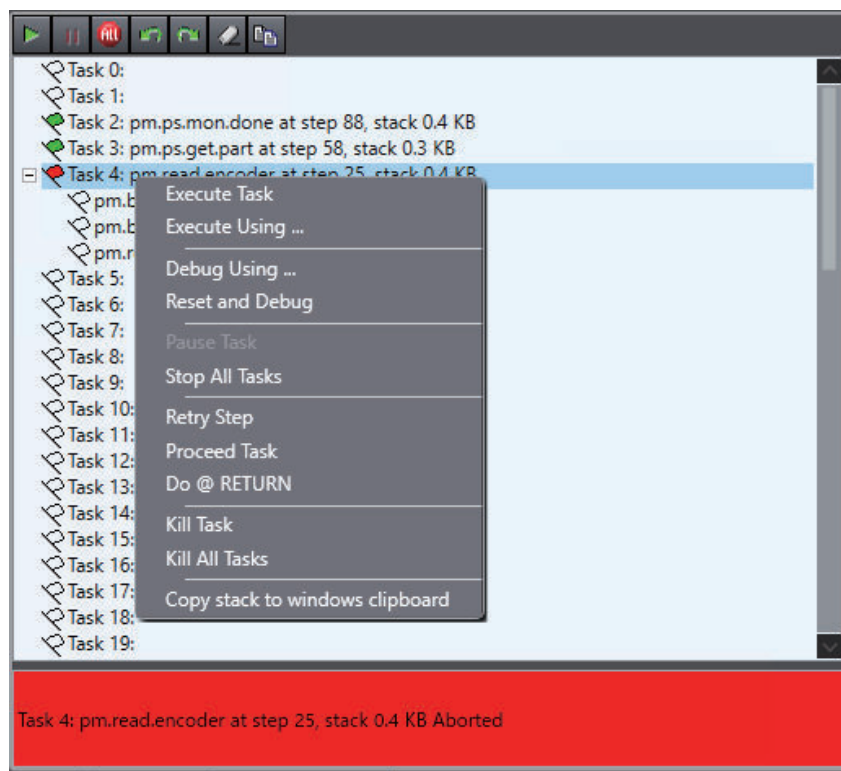

Other Function	Description
Execute Using...	Prompts for the name of the program to execute on the selected task.
Debug Using...	Prompts for the name of a program to debug, primes the specified program, and opens the V+ program in the Edit Pane.
Reset and Debug	Resets the program and open the V+ program in the Edit Pane for the selected task.
Do @ RETURN	Execute the task when the <b>Return</b> key is pressed.
Kill All Tasks	Clears all tasks.

### 7-4-5 IO Watcher

Select IO Watcher to display an interface for monitoring the state of digital I/O signals (inputs, outputs, soft signals, and robot signals) on the connected controller. Digital output signals and soft signals can be turned ON and OFF manually by clicking the signal button (■ ■).

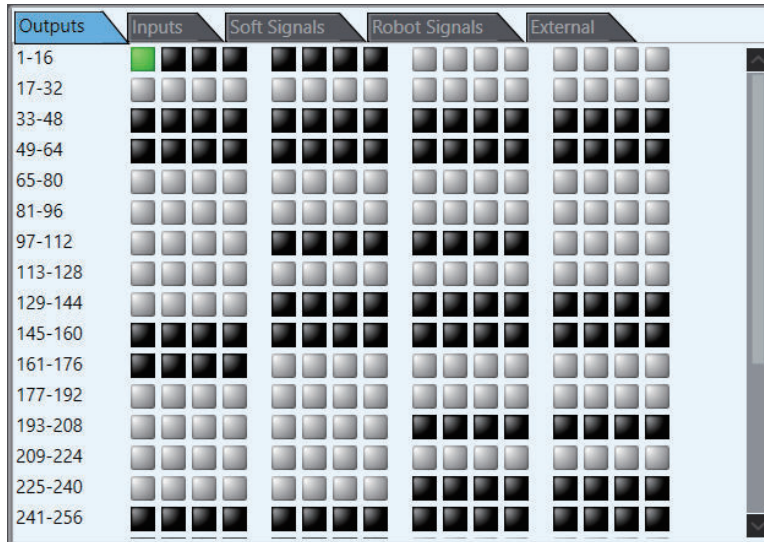

#### Additional Information

When the EMULATION mode is enabled, digital input signals can be manipulated.

### 7-4-6 V+ File Browser

The V+ File Browser allows you to browse files and folders in the SD Memory Card mounted on the Robot Integrated CPU Unit. It is only available while online with the Robot Integrated CPU Unit.

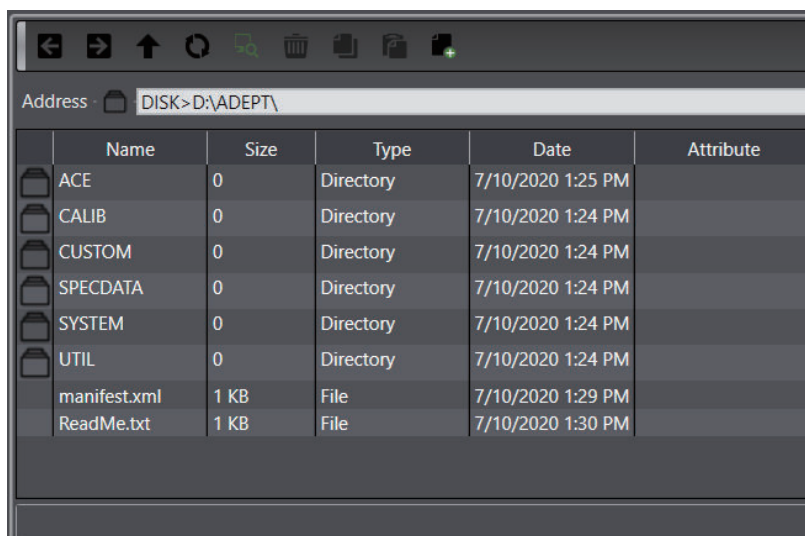

The V+ File Browser works with the Windows clipboard to enable easy transferring of files to and from the Robot Integrated CPU Unit's SD Memory Card.

Icons in the V+ File Browser toolbar enable you to perform common file browser functions such as navigation, creating new folders, rename, delete, cut, copy, and paste. Right-clicking a file or folder will also display a menu with common file browser functions and other items described below.

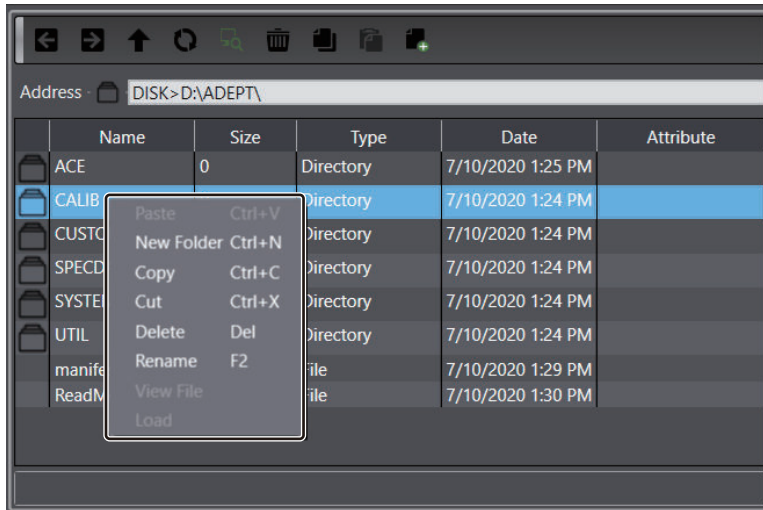

## View File

Selecting **View File** will open the file in a quick-view window without the need for transferring the file to the PC. Available for program, variable, and text files.

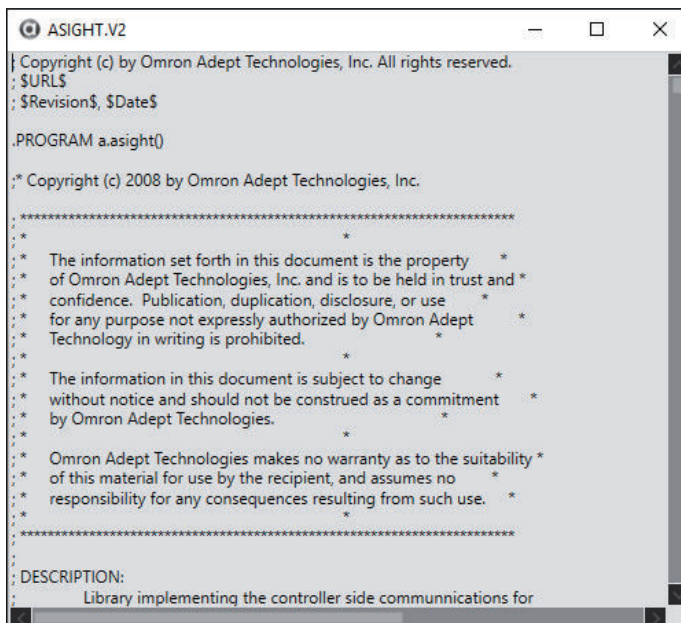

## Load

Selecting **Load** will transfer the contents of the selected file from disk to system memory.

## 7-4-7 Virtual Front Panel

The Virtual Front Panel provides a simulated front panel for testing robot behavior when mode selection, robot power, and E-stop conditions are changed.

In the Emulation mode, full use of the Virtual Front Panel is possible.

When connected to a physical controller, Virtual Front Panel functions are read-only.



### WARNING



When building a robot system that includes this CPU Unit or an Omron robot, be sure to ensure compliance with the laws and regulations on the safety of industrial robots in the country or region where the robot is operating in design and operation of the system. Refer to *Robot Safety Guide (Cat. No. 1590)* for details.



Virtual Front Panel functions are described below.



Icon	Item
	MODE SELECTION switch
	MANUAL mode
	AUTOMATIC mode

Icon	Item
	ROBOT POWER button
	E-Stop button

## Mode Selection

Switches between the MANUAL and AUTOMATIC mode. In the AUTOMATIC mode, executing programs control the robot, and the robot can run at full speed. In the MANUAL mode, the system limits robot speed and torque so that an operator can safely work in the cell. The MANUAL mode initiates software restrictions on robot speed, commanding no more than 250 mm/sec. In the MANUAL mode, no high speed mode is available. Refer to the user's manual of each robot for details.

## Robot Power

The **Robot Power** button enables power to the robot motors. This button has an indicator to show the following robot power states.

- OFF: Power is not supplied to the robot
- ON: Power is supplied to the robot
- Blinking: Power will be supplied if the **Robot Power** button is pressed within the specified Safety Timeout period.

Refer to *Configure Robots Safety Timeout* on page 5-17 for more information.

Robot power must be active to operate the robot.



### Precautions for Correct Use

Enabling power to the robot motors is not possible while in an E-Stop state.

## E-Stop

Behaviors at an emergency stop can be tested and monitored with the **E-Stop** button on the Virtual Front Panel. Use the ESTOP Channel area to simulate various E-Stop system functions.



Refer to *eV+3 Keyword Reference Manual (Cat. No. I652)* for details.



## 7-5 Overview of Robot Integrated System Simulation

You can simulate your Robot Integrated System on the PC using the Sysmac Studio's 3D Simulation function.

### 7-5-1 Schema of Robot Integrated System Simulation

This section describes the structure of Robot Integrated System simulation.

After a simulation starts, the V+ emulator boots up on Sysmac Studio, as a part of the Controller's simulator. A robot moves in the 3D visualizer by V+ programs that run on the V+ emulator. Mechanical components move on the 3D visualizer by sequence control programs that run on the Controller's simulator.

Behaviors of parts can be displayed in the 3D Visualizer by executing Shape Scripts concurrently with the simulation. You can see the parts move along with movements of the robot and mechanical components in the 3D Visualizer.

Refer to *Sysmac Studio 3D Simulation Function Operation Manual (Cat. No. W618)* for details of Shape Script.

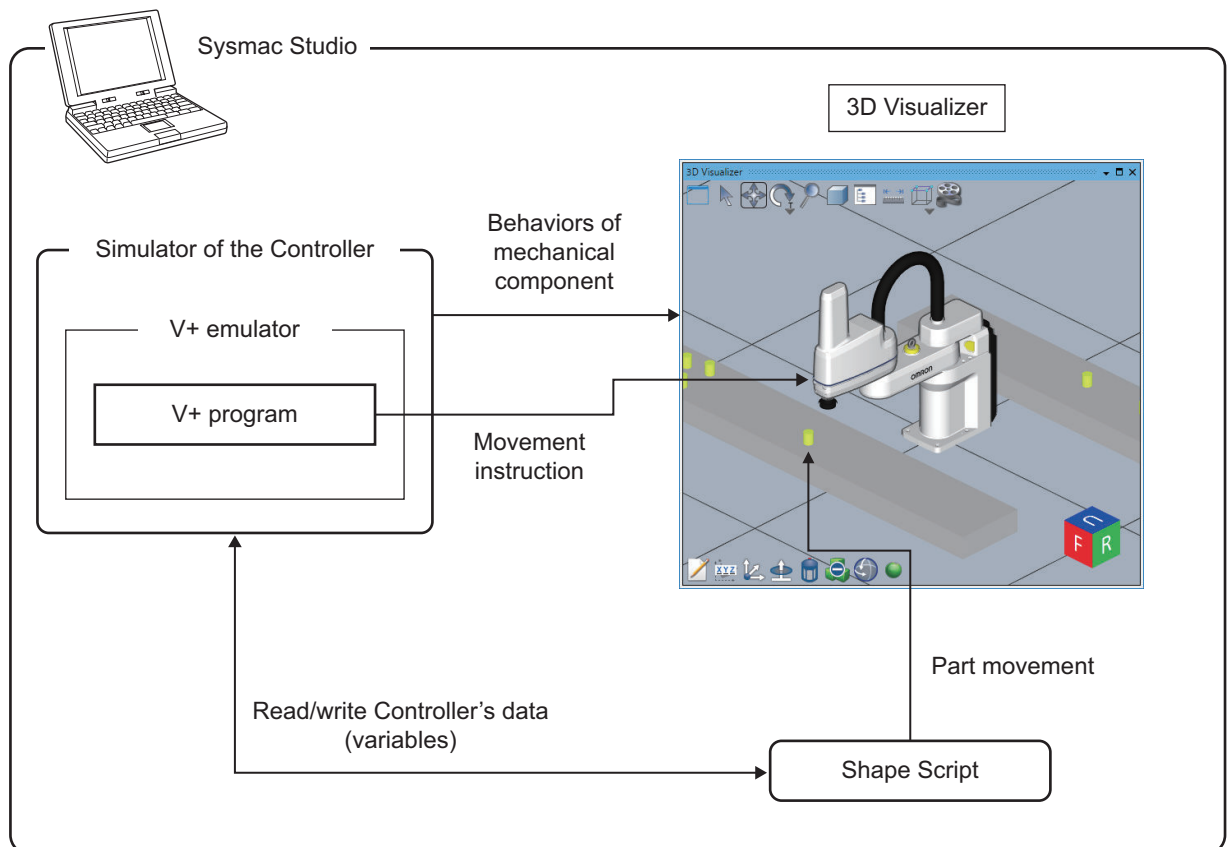



### **Additional Information**

---

A sequence control program and a V+ program or shape script can be debugged at the same time.

While data tracing and debugging the sequence control program, you can switch the device to RobotControlSettings or Application Manager to debug a V+ program or shape script.

---

## 7-6 How to Start Simulation

This section describes how to start a 3D simulation of the robot system with the Robot Integrated CPU Unit. Refer to *Sysmac Studio 3D Simulation Function Operation Manual (Cat. No. W618)* for details of descriptions and procedures common with 3D simulation function.

### CAUTION

The simulator, which uses the 3D Visualizer, simulates the operations of a PLC and a robot. There are differences in movement and timing between actual PLC and robot. In addition to debugging the program in the simulator, be sure to check the operation on the physical machine before operating it. Unexpected operation of the equipment may occur an accident.



### 7-6-1 Activating Robot Simulation Function

3D simulation of the robot system with the Robot Integrated CPU Unit must be run in the EMULATION mode.

Refer to 4-1-1 *Starting the Sysmac Studio* on page 4-2 for how to open a project in the EMULATION mode.



#### Additional Information

Follow the procedure below to enable the EMULATION mode after you have opened the project.

- 1 Select **Controller – Enable emulation mode** from the main menu.

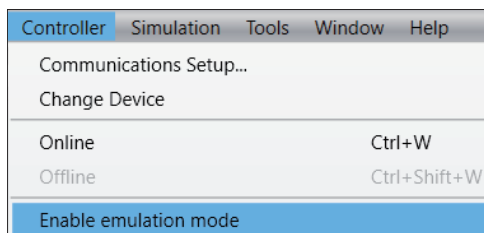

Confirmation dialog box is displayed.

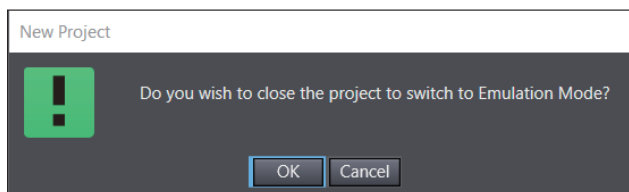

- 2 Click the **OK** button.  
The project is re-opened in the EMULATION mode.

## 7-6-2 Starting Robot Simulation

Procedure for the 3D simulation of the robot system with Robot Integrated CPU Unit is shown below.

- 1 Select the Controller from the device list in Multiview Explorer.

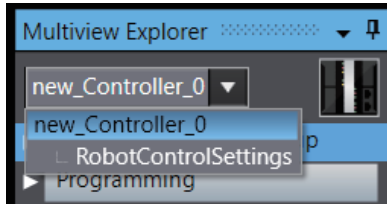

- 2 Select **Run – Simulation** from the main menu.  
Now Sysmac Studio go Online with the Controller's simulator.

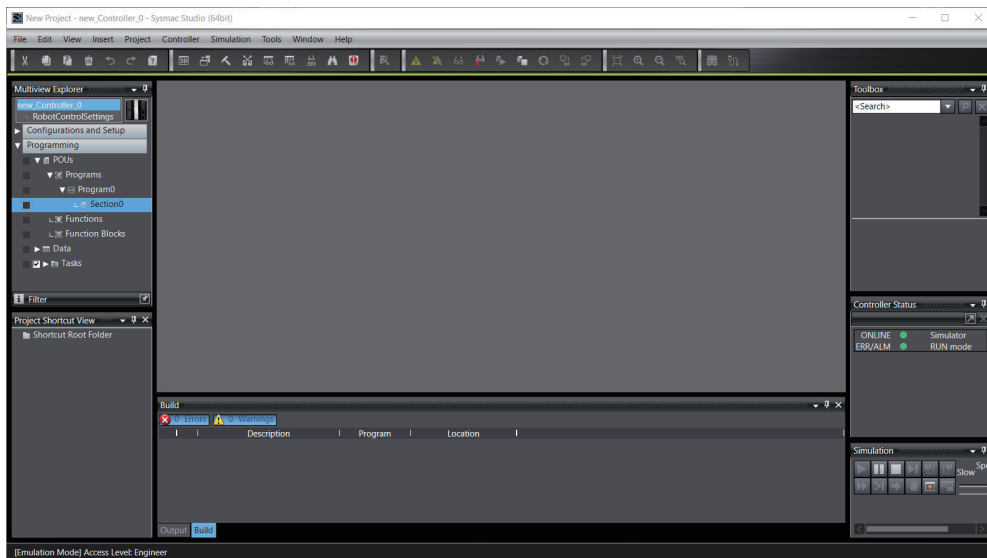

### Additional Information

Writing and reading the controller settings in the robot control function modules, V+ programs, and V+ variables require online connection to the subdevice *RobotControlSettings*. Confirm the top of the Edit pane is green when selecting **RobotControlSettings** from a Multiview Explorer's device list.

If not, the connection with *RobotControlSettings* has been offline. Select the controller in the device list, then abort and restart the simulation.

## 7-7 Teaching Robots

This section describes how to teach the robot in the simulation.

The following teaching methods are available. Select a proper method in response to movement and positioning accuracy.

Method	Description	Reference
Teaching on 3D Visualizer	Operate the tool tip in the <b>3D Visualizer</b> to set its position or path.	<i>7-7-2 Teaching on 3D Visualizer</i> on page 7-43
Teaching on V+ Jog Control Pane	Operate the tool tip in the <b>V+ Jog Control Pane</b> to set its position or path.	<i>7-7-3 Teaching on V+ Jog Control Pane</i> on page 7-47
Teaching with Robot Path Planning	Set the start point and end point of the tool tip to automatically generate waypoints to avoid obstacles.	<i>7-7-5 Teaching with Robot Path Planning</i> on page 7-52

### 7-7-1 Preparing V+ Location Variables

Location of the tool tip is saved to a location type V+ variable through a teaching operation. This variable is called as V+ Location Variable.

Register V+ location variables you use for teaching in advance.

Refer to *6-2-2 Registering V+ Variables* on page 6-3 for how to register V+ variables.

### 7-7-2 Teaching on 3D Visualizer

Operate the tool tip of the robot in the 3D Visualizer to position it. An intuitive robot operation is possible as the tool tip follows the mouse cursor. This method is suitable to determine the approximate position or orientation. It is also possible to use the snap function to specify the position where the tool tip comes in contact with 3D shape data. The operation is performed with a Simulator connection established.

- 1** Select **RobotControlSettings** from a Multiview Explorer's device list.
- 2** Select **View – 3D Visualizer** from the main menu.

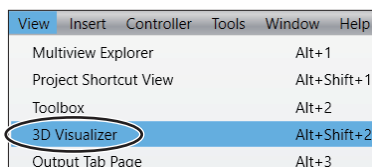

**3D Visualizer** is displayed.

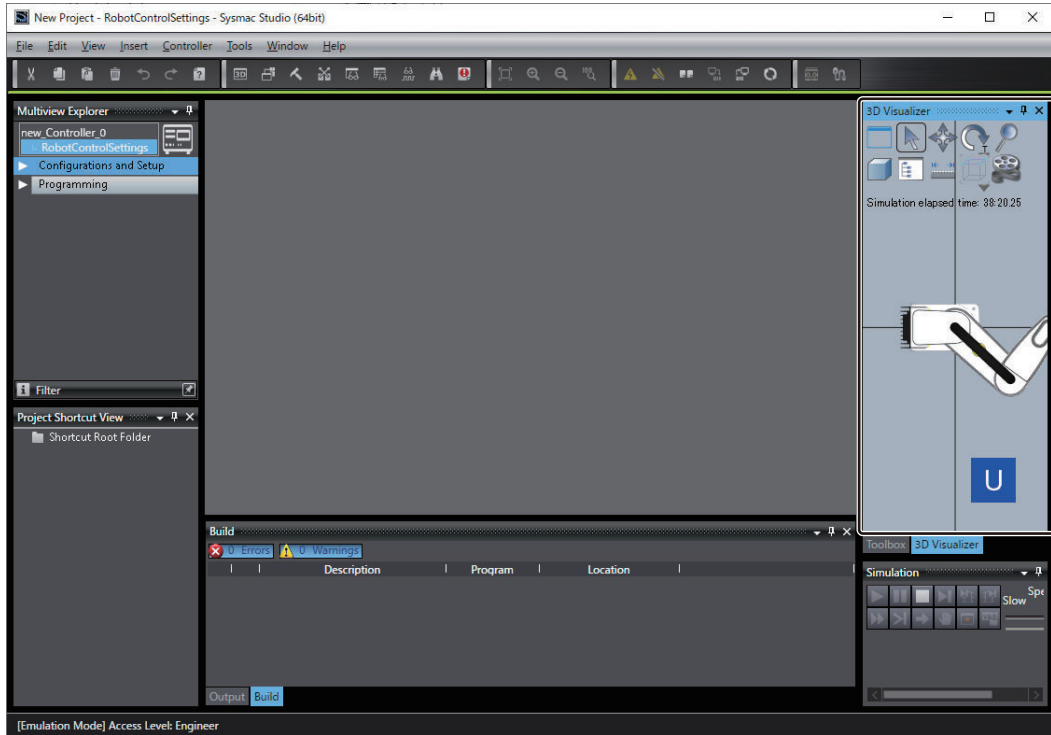

- Put the cursor on the tool tip of the robot on the 3D Visualizer. Then drag the Move icon beside of the cursor.

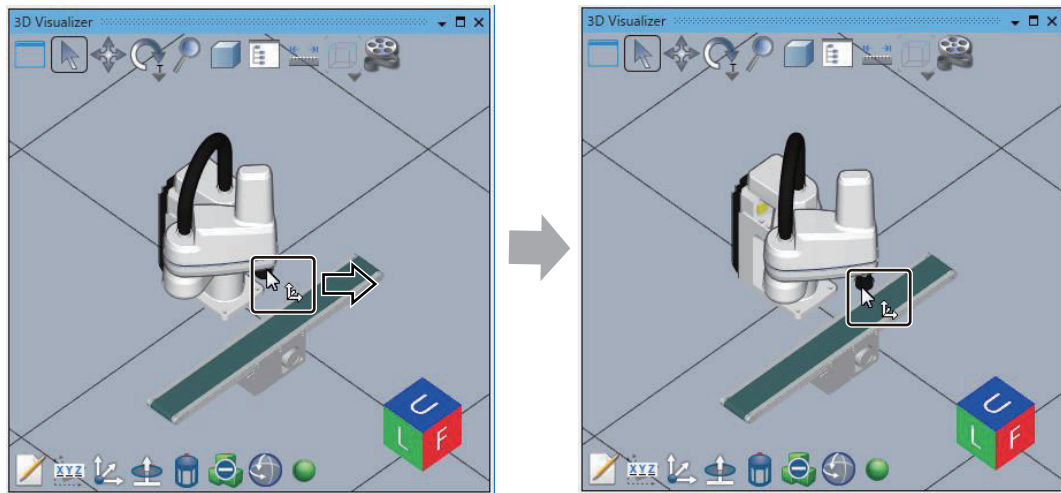

The tool tip moves following the cursor.

- Drop the cursor to where you want to move the tool tip.

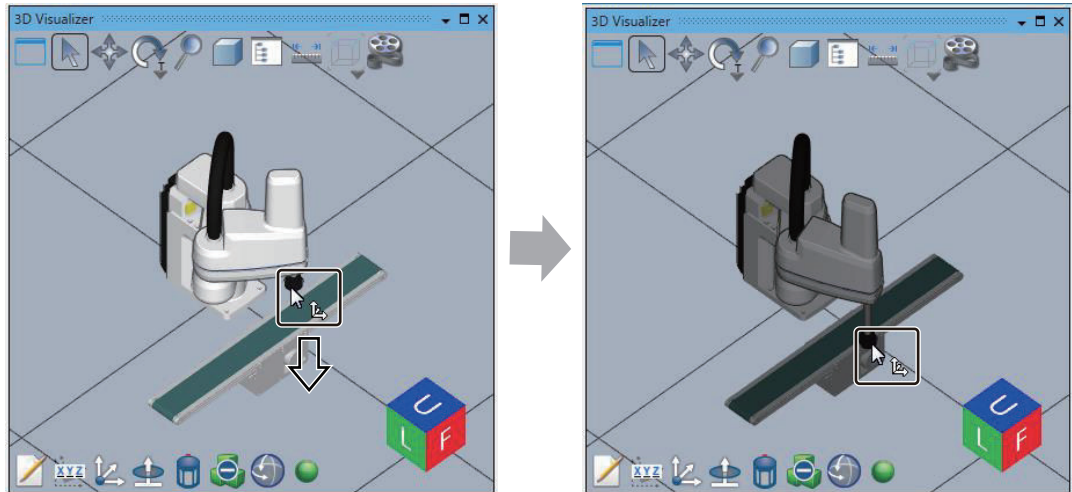

When the tool tip collides with other 3D shape data, the robot and the 3D shape data, including the tool tip, will be gray. Please use it as a reference for positioning.

You can position the tool tip by having it snap to a specific point or edge, or the center of gravity of a face, in the 3D shape data.

Refer to *Snapping Tool Tip* on page 7-45 for details on the snap function.

- 5** Save the robot's position to the V+ location variable.  
Refer to *7-7-4 Saving Current Robot Position* on page 7-50 for how to save to the V+ variable.
- 6** Repeat Step 3 to 5 to save the positions necessary for the robot's movements.

## Snapping Tool Tip

The snap function brings the robot's tool tip in contact with a specific position of 3D shape data. Use it to specify the position of the tool tip when using a robot to pick an object.

- 1** Select the robot or tool tip and then click the Snap icon or press the T key.



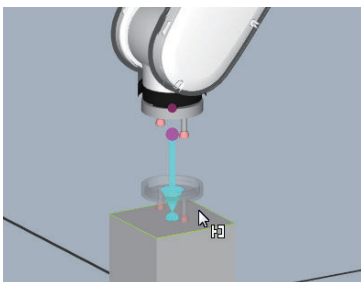

- 2** Move the cursor to where you want to snap it to display candidate points of the snap destination. Click one of the candidate points to snap it to that position.

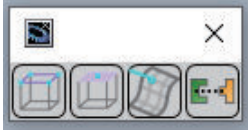

To change the mode of snapping, click the icon and select its function in the following window. Or, press the T + number keys. To close the window, click X.



The following shows the position specification methods that you can select in the window.

Icon	Name	Function	Shortcut keys
	Snap to Edge	Click the purple dot at the tool tip and move the mouse cursor close to 3D shape data. This highlights the nearest edge to the mouse cursor that the tool tip can be snapped to. The dot at either end or the center of the highlighted edge is emphasized, and placing the mouse cursor over the dot shows an arrow indicating the snapping direction. In addition, a preview of the snap position appears, which shows the 3D shape data connected to the tool tip in the snap position. Now you can click the mouse to snap the tool tip to the position.	T + 1
	Snap to Face	Click the purple dot at the tool tip and move the mouse cursor close to 3D shape data. This highlights the nearest face to the mouse cursor that the tool tip can be snapped to. The dot at the center of gravity of the highlighted face is emphasized, and placing the mouse cursor over the dot shows an arrow indicating the snapping direction. In addition, a preview of the snap position appears, which shows the 3D shape data connected to the tool tip in the snap position. Now you can click the mouse to snap the tool tip to the position.	T + 2
	Snap to Surface (nearest point)	Click the purple dot at the tool tip and move the mouse cursor close to 3D shape data. This highlights the nearest surface to the mouse cursor that the tool tip can be snapped to. The dot on the highlighted surface that is nearest to mouse cursor is emphasized, and an arrow showing the snapping direction appears. In addition, a preview of the snap position appears, which shows the 3D shape data connected to the tool tip in the snap position. Now you can click the mouse to snap the tool tip to the position.	T + 3



Icon	Name	Function	Shortcut keys
	Snap to Mount	<p>Click the purple dot at the tool tip and move the mouse cursor close to 3D shape data. This emphasizes the nearest mount point to the mouse cursor that the tool tip can be snapped to. In addition, a preview of the snap position appears, which shows the 3D shape data connected to the tool tip in the snap position. Now you can snap the tool tip to the position of the emphasized mount point.</p> <p>To use this function, you need to set mount points in the target 3D shape data in advance, in the position to snap the tool tip to. At this time, select <i>Robot</i> as the <b>Type Name</b> in the mount point settings.</p> <p>Refer to the <i>Sysmac Studio 3D Simulation Function Operation Manual (Cat. No. W618)</i> for how to set mount points.</p>	T + 4



#### Additional Information

- In addition to the tool tip, you can select the robot or end-effector as the snap target. Click the Snap icon to display the dots that you can select in purple.
- For our articulated robots Viper, the tool tip will be automatically oriented in the direction of the plane perpendicular to the point where it is snapped.
- A preview of the snap position will be displayed for the following objects.
  - a) Box
  - b) Cylinder
  - c) CAD data
  - d) Mechanical component
  - e) Custom mechanics
  - f) Parallel link model

When an end-effector mounted on a robot is snapped, a preview of the above objects a) to f) that have the end-effector set as the parent will be displayed.
- You can change the highlight color of the snap position. Change it in the option settings. Refer to *A-1 Option Settings* on page A-2 for details.

### 7-7-3 Teaching on V+ Jog Control Pane

Configure robot position in the **V+ Jog Control Pane**. This method enables movements depending on robot's coordinate system or joint axes.

Refer to *7-3 V+ Jog Control* on page 7-20 for details of the **V+ Jog Control Pane**. The operation is performed with a Simulator connection established.

- 1** Select **RobotControlSettings** from a Multiview Explorer's device list.
- 2** Select **View – 3D Visualizer** from the main menu.  
**3D Visualizer** is displayed.
- 3** Select **View – V+ Jog Control** from the main menu.

View	Insert	Controller	Tools	Window	Help
Multiview Explorer					Alt+1
Project Shortcut View					Alt+Shift+1
Toolbox					Alt+2
3D Visualizer					Alt+Shift+2
Output Tab Page					Alt+3
Watch Tab Page					Alt+4
Watch Tab Page(Table)					Alt+Shift+4
Cross Reference Tab Page					Alt+5
Build Tab Page					Alt+6
Event Log					
Search and Replace Results Tab Page					Alt+7
Simulation Pane					Alt+8
Differential Monitor					Alt+9
Smart Project Search					Ctrl+Shift+F
Recently Closed Windows					Ctrl+Shift+H
Clear Recently Closed Windows History					
<b>V+ Jog Control</b>					<b>Alt+Shift+J</b>
Task Status Control					Alt+Shift+T

**V+ Jog Control** Pane is displayed.



- 4 Select either of coordinate system, **World**, **Joint**, or **Tool**, from the **Jog Control** drop-down list in the **Jog Control** Tab Page.



**World**, **Joint**, and **Tool** specify the robot's position by robot coordinate system, joint coordinate system, and tool tip's coordinate system, respectively.

Select **World** for example.

- 5** Click a lamp in the **Jog Control** area in the **V+ Jog Control** Pane.  
The clicked lamp turns green. You can operate the robot with the axis of green lamp.



- 6** Keep pressing either of the arrow button with **+** or **-** in the **Jog Control** area in the **V+ Jog Control** Pane.  
**+** and **-** represent the positive or negative direction on the specified coordinate system respectively. For example, in the robot coordinate system, the following direction of the arrow is the positive direction.



The robot will move along with the coordinate axis of the specified coordinate system while you are pressing the arrow button.

- 7** Repeat Step 4 to 6 to make the robot in the specified position or orientation.
- 8** Save the robot's position to the V+ location variable.  
Refer to *7-7-4 Saving Current Robot Position* on page 7-50 for how to save to the V+ variable.
- 9** Repeat Step 4 to 8 to save the positions necessary for the robot's movements.

### 7-7-4 Saving Current Robot Position

You must save current robot position that you have set through teaching to a V+ location variable. Saving procedure is shown below.

- 1** Select **View – V+ Jog Control** from the main menu.  
**V+ Jog Control** Pane is displayed.
- 2** Click **Location** in the **V+ Jog Control** Pane.



An area to set location variables appears.

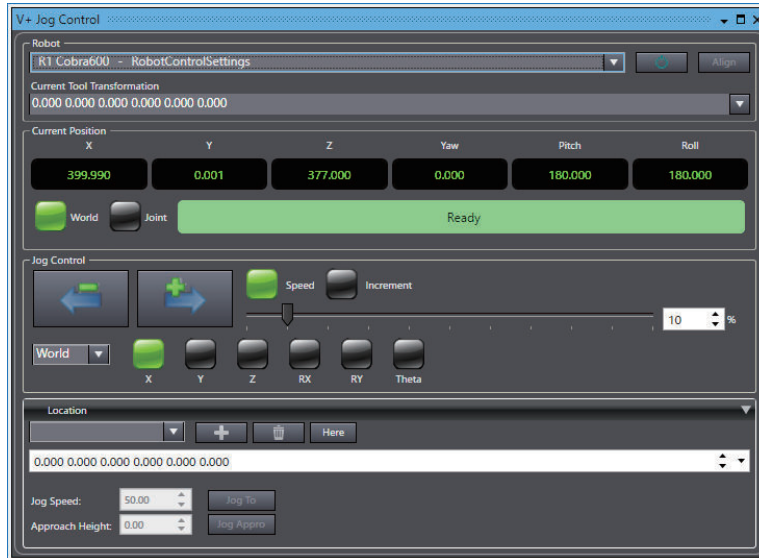

- 3** Select a variable or element of array variable to which you want to save a current position from the drop-down list.

The name of the selected variable and the variable values in the Controller that is connected online are shown.



- 4** Click the **Here** button in the **Location** area in the **V+ Jog Control** Pane.

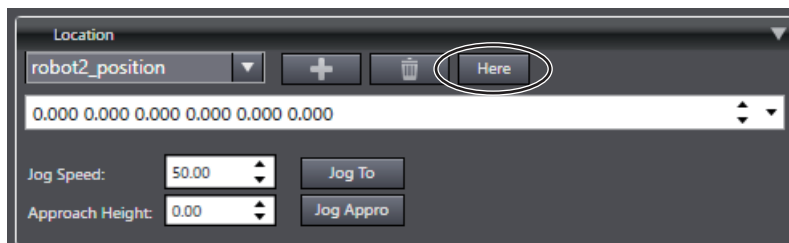

The current position value is set in the **Initial Value** and **Online Value** columns or the **Value** column for the selected variable.

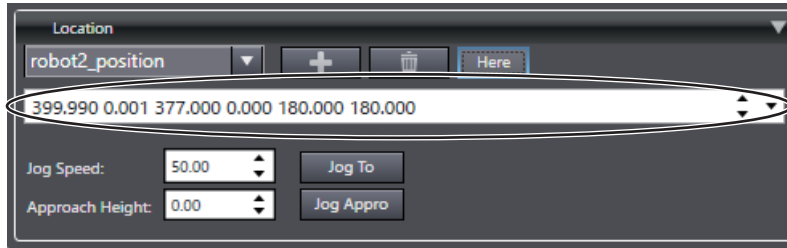

### 7-7-5 Teaching with Robot Path Planning

In the Robot Path Planning function, users set locations of the start and end points of the tool tip to generate points along the path to avoid obstacles and save the point locations to a V+ Location Variable.

This enables the robot to pick a part at the start point and place it at the endpoint avoiding contact with obstacles.

In addition, in an operation of picking a part in one box type 3D shape data such as a pallet or container and placing it in another box type 3D shape data over obstacles, it is possible to generate a path so that the IO EndEffector and robot arm do not come in contact with the box type 3D shape data.

### Robot Movements Supported by Robot Path Planning

The Robot Path Planning function supports the following movements to avoid obstacles.

Supported movement	Conceptual image
Pick the part at the start point in the positive Z direction, avoid obstacles, and place it at the end point.	
Pick the part at the start point in the negative X direction, avoid obstacles, and place it at the end point.	

## Teaching Procedure

Use the following steps to perform teaching with Robot Path Planning.

Shown here is an operation example for picking a part at the tip of an IO EndEffector attached to the tool tip.

Step	Description
1. Configuring Collision Detection Settings for Obstacles	Configure collision detection settings for obstacles to avoid and box type 3D shape data that contains the part.
2. Setting up IO EndEffector	Register the IO EndEffector and set the offset of the IO EndEffector tip. Configure also the settings to specify the start point and end point for the end-effector tip in the <b>V+ Jog Control</b> Pane.
3. Automatically Generating and Saving Waypoints	In the <b>Robot Path Planning</b> dialog box, automatically generate points along the path to avoid obstacles and save the coordinate values of the points to a V+ Location Variable.

## Configuring Collision Detection Settings for Obstacles

To detect collisions with obstacles, configure the collision detection settings in the Collision Filter Tab Page.

Specifically, register the obstacles in collision detection groups. To use box type 3D shape data, also register the box type 3D shape data in collision detection groups.

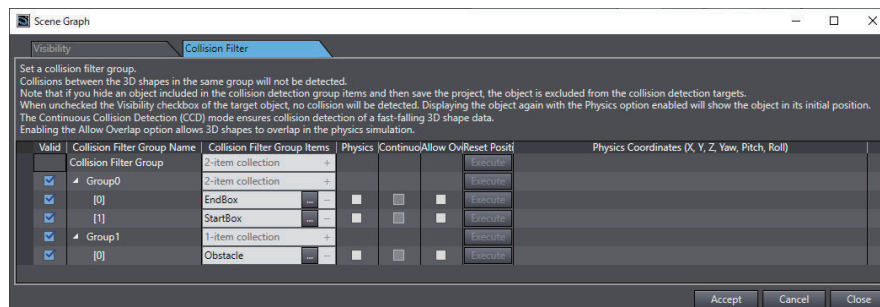

Refer to *Collision Filter Tab Page* on page 7-9 in *7-2-3 Description of Icons* on page 7-4 for how to configure the collision detection settings in the Collision Filter Tab Page.

## Setting Up IO EndEffector

Register the IO EndEffector tip to pick the part and set the offset of the IO EndEffector tip. Configure also the settings to specify the start point and end point for the end-effector tip in the **V+ Jog Control** Pane.

### ● Setting IO EndEffector Tip Offset

Register the IO EndEffector tip to use in the **IO EndEffector** Tab Page and set the offset of the IO EndEffector tip in **Tip Offset**.

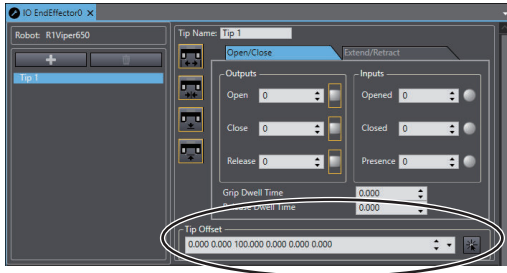

Refer to the *Sysmac Studio Robot Integrated System Building Function with IPC Application Controller Operation Manual (Cat. No. W621)* for details on the IO EndEffector settings.

### ● Setting Tool Transformation in V+ Jog Control

Configure the settings to specify the start point and end point for the IO EndEffector tip in the **V+ Jog Control** Pane.

With a Simulator connection established, select the tip name that you registered in the **IO EndEffector** Tab Page from the **Current Tool Transformation** drop-down list in the **V+ Jog Control** Pane.

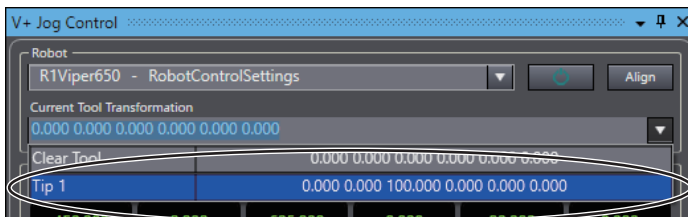

Refer to 7-3-2 *V+ Jog Control Setting Items* on page 7-21 for details on the V+ Jog Control settings items.

## Automatically Generating and Saving Waypoints

In the **Robot Path Planning** dialog box, automatically generate points on the path to avoid the obstacles and, after commissioning the robot, save the generated waypoints to a V+ Location Variable. The operation is performed with a Simulator connection established.

- 1 Select **RobotControlSettings** in the Multiview Explorer, and select **Tools – Robot Path Planning** from the main menu.

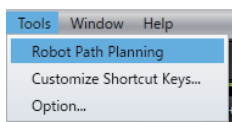

The **Robot Path Planning** dialog box is displayed.



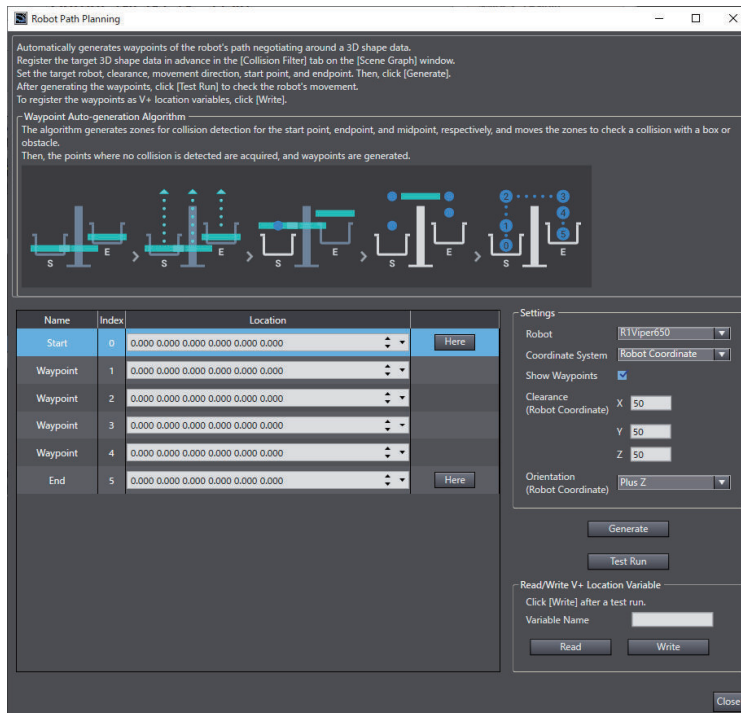

Refer to *Robot Path Planning Settings* on page 7-57 for details on the settings in the **Robot Path Planning** dialog box.

- 2 In the 3D Visualizer, move the IO EndEffector tip to the point to start operation and click the **Here** button for Start.

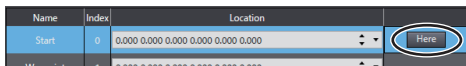

The coordinate value of the IO EndEffector tip is reflected in the **Location** of the start point.

- 3 Move the IO EndEffector tip to the point to end operation and click the **Here** button for End.

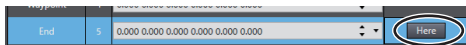

The coordinate value of the IO EndEffector tip is reflected in the **Location** of the end point.

- 4 Make the necessary settings in the **Settings** area.

- 5 Click the **Generate** button.

The coordinate values of Waypoint 1 to Waypoint 4 of the robot are automatically generated.

Name	Index	Location
Start	0	500.072 -241.067 53.883 -131.800 176.899 -129.450
Waypoint	1	500.072 -241.067 193.883 -131.800 176.899 -129.450
Waypoint	2	500.072 -241.067 403.883 -131.800 176.899 -129.450
Waypoint	3	500.072 197.053 403.883 -131.800 176.899 -129.450
Waypoint	4	500.072 197.053 193.883 -131.800 176.899 -129.450
End	5	500.072 197.053 53.883 -131.800 176.899 -129.450

At this time, the start point, waypoints, and end point are displayed in blue in the 3D Visualizer.

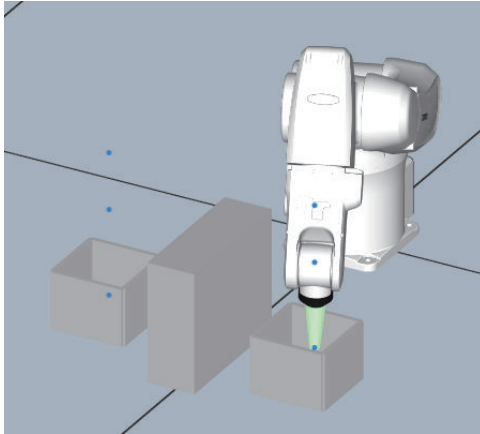

- 6 Click the **Test Run** button and check the robot's movements.
- 7 If the tool tip does not collide against the obstacles and there is no problem with the robot's movements, enter the variable name in **V+ Location Variable** and click the **Write** button. The coordinate values of the start point, waypoints, and end point are saved as a V+ Location Variable, which is an array variable.



#### Additional Information

---

- You can also directly enter the coordinate values of the start point and end point.
  - If there is no box type 3D shape data at the start point or end point, the waypoint of index 1 is at the same location as that of Index 2. Similarly, the waypoint of index 4 is at the same location as that of Index 3.
  - To pick a part from box type 3D shape data, or to place a part in box type 3D shape data, set the **Clearance** considering the size of the IO EndEffector and part so that the IO EndEffector and part do not come in contact with the box type 3D shape data at the start point and end point.
-

## Robot Path Planning Settings

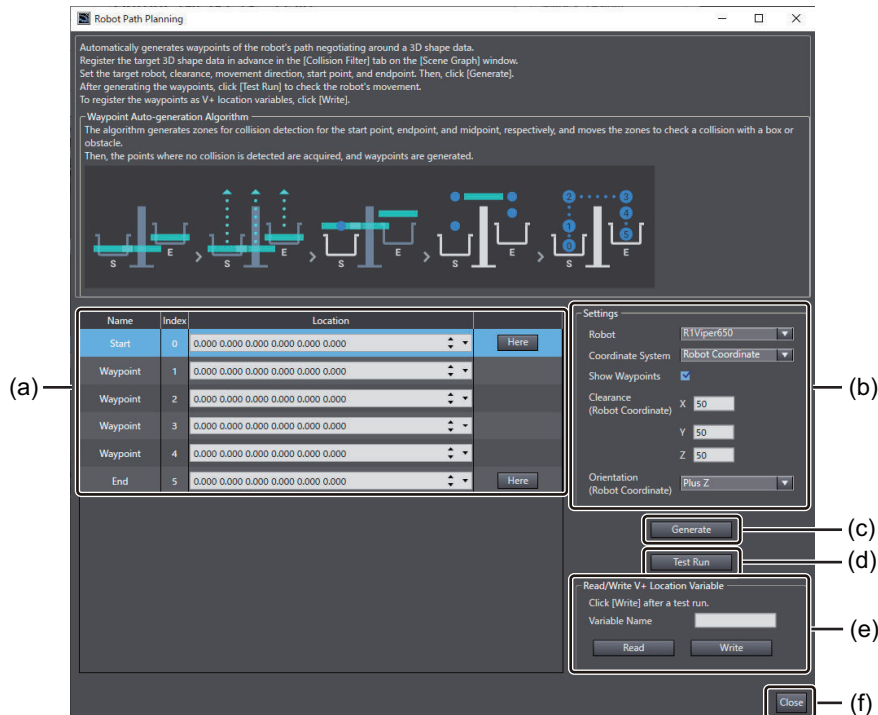

	Setting Item	Description	Set value	Initial value	
(a)	Location list	Name	The start point, waypoints, and end point are displayed. You cannot change the text strings.	---	---
		Index	The indexes of the points are displayed. You can specify the index to access the coordinate value of each point saved in the V+ Location Variable, array variable.	---	---
		Location	The location of each point is displayed.	X, Y, and Z: -1,000,000.000 to 1,000,000.000 y and r: -180.000 to 180.000 p: 0.000 to 180.000	0.000 for all
		Here button	Click this button to acquire the coordinate value of the tool tip in the 3D Visualizer.	---	---
(b)	Settings	Robot	Select the target robot from the robots registered in the project.	Robots registered in RobotControlSettings	Robot registered at the top of RobotControlSettings
		Coordinate System	Select the coordinate system. The coordinate values displayed in Location list will be updated if the coordinate system is changed.	Robot Coordinate World Coordinate	Robot Coordinate
		Show Waypoints	Select or clear this check box to show or hide the start point, waypoints, and end point displayed in the 3D Visualizer.	Checked or unchecked	Checked

	Setting Item		Description	Set value	Initial value
		Clearance	Set the clearance between the tool tip and obstacles in the robot coordinate system. To pick a part from box type 3D shape data, or to place a part in box type 3D shape data, set the clearance considering the size of the IO EndEffector and part.	X, Y, and Z: 1 to 100	50
		Orientation	Select the direction in which to avoid obstacles.	Plus Z Minus X	Plus Z
(c)	<b>Generate</b> button		Click this button to generate waypoints in order to avoid obstacles according to the settings.	---	---
(d)	<b>Test Run</b> button		Click this button to perform commissioning in which the tool tip in the 3D Visualizer moves through the generated waypoints in the path.	---	---
(e)	Read/ Write V+ Location Variable	Variable Name	Enter a variable name for the V+ Location Variable.	Text string	Blank
		<b>Read</b> button	Click this button. If the V+ Location Variable entered in <b>Variable Name</b> already exists, the variable values will be read and displayed in the Location list.	---	---
		<b>Write</b> button	Click this button to write the coordinate value of each point in the Location list to the V + Location Variable with the name entered in <b>Variable Name</b> .	---	---
(f)	<b>Close</b> button		Click this button to close the <b>Robot Path Planning</b> dialog box.	---	---

## 7-8 Debugging Robot Movement

This section describes how to debug robot movements. Robot settings and V+ programs determine the robot's movements.

### 7-8-1 Commissioning the Robot

Run V+ programs to check the robot's movements on the 3D Visualizer.  
Allocate V+ program to a task in Task Manager in Task Status Control.

- 1 Select **View – Task Status Control** from the main menu.  
Task Status Control Tab Page is displayed.

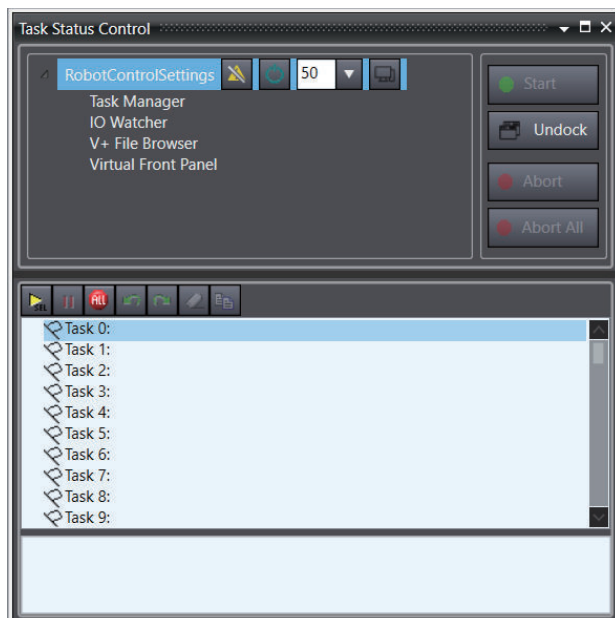

- 2 Drag V+ program on Multiview Explorer and drop it to a task shown in Task Status Control. Or, right-click V+ program on Multiview Explorer, then select a task number to which you want to allocate the program from **Execute on Task** or **Debug on Task**.  
The V+ program is allocated to the selected task and the V+ program will be executed.  
Refer to *7-4 Task Status Control* on page 7-28 for task executing function through Task Status Control.
- 3 Select **View – 3D Visualizer** from the main menu.  
3D Visualizer is displayed.  
You can see the robot move according to the V+ program.

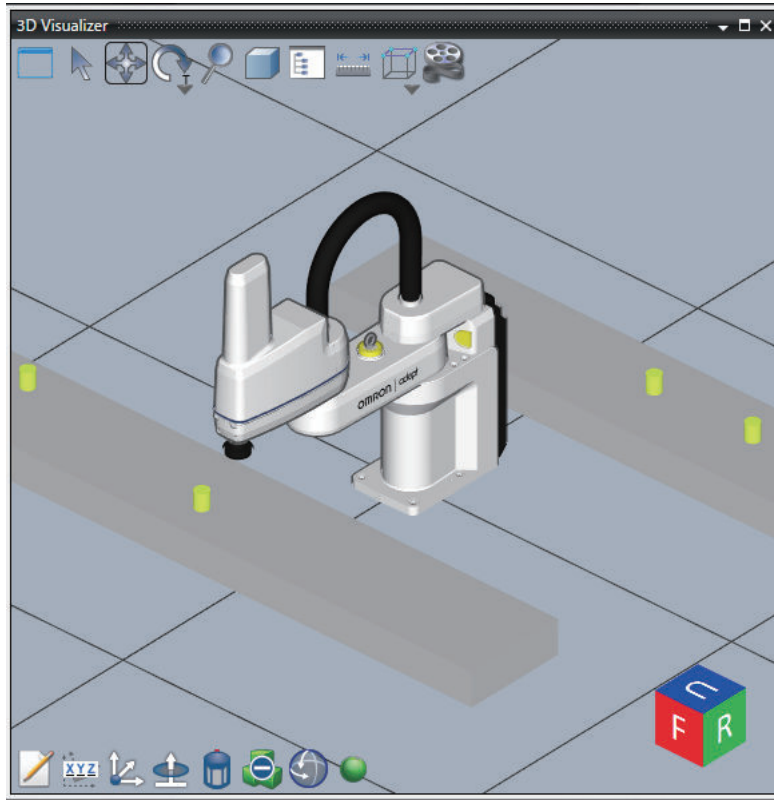

Refer to 7-2 *3D Visualizer* on page 7-4 for functions regarding robot operation on the 3D Visualizer.

- 4** If necessary, modify the V+ program.  
Refer to 7-9-2 *Program Debugging* on page 7-61 for how to debug V+ program.

## 7-9 Program Debugging

This section describes debugging of V+ programs.

Refer to *Sysmac Studio Version 1 Operation Manual (Cat. No. W504)* for the debug function of sequence control programs.

### 7-9-1 Variable Monitoring

You can use V+ Watch to monitor specific variables during developing or debugging a V+ program. Variables can be added to V+ watch Tab Page in different ways as described in the following. Contents in the Watch Tab Page will be saved together with a project. Refer to 4-3-10 V+ Watch Tab Page on page 4-9 for details.

Variable/Expression	Value	Source	Task	Program	Type
robot1_position	69.000 -79.000 -182.000 0.000 80.000 5.000	/new_Controller_0/Controller Settings			Location
robot2_position	-30.000 215.000 -42.000 0.000 2.000 75.000	/new_Controller_0/Controller Settings			Location
robot3_position	-52.000 26.000 -255.000 -180.000 24.000 -180.000	/new_Controller_0/Controller Settings			Location

### WARNING

Check operations of the created user programs, data, and setting values carefully before proceeding to normal operation.



### Adding Variables to V+ Watch Tab Page

Use one of the following methods to add variables to the V+ Watch Tab Page.

- Select one or more variables in the + Variable Editor and right-click. Selecting **Add to Watch** will place these variables in the V+ Watch Tab Page.
- Right-click in the V+ Watch Tab Page to select **New**. Enter a name of the variable to add to the V+ Watch.
- Right-click a variable name in the V+ Program Editor. Selecting **Add to Watch** will place these variables in the V+ Watch Tab Page.

### 7-9-2 Program Debugging

The V+ Program Editor provides debugging tools when a connection to the simulator in the EMULATION mode or an online connection to the Robot Integrated CPU Unit is present. It allows interactive program stepping while simultaneously displaying code variables and states. If a program in one module steps into a program in another module, the V+ Program Editor will automatically step you into that program. Breakpoints in the code can be added or removed while debugging. You can have as many active debugging sessions as there are tasks.



### Additional Information

If you want to modify a V+ program during an online connection, select the V+ Edit mode. Refer to *V+ Edit Mode* on page 8-18 for details.

Use one of the following methods to access the V+ Program Editor debugging functions for a program.

- Right-click a program in Multiview Explorer and select **Debug on Task**. Select a task and the program will run with the V+ debugging functions activated.
- Right-click a stopped task in the Task Manager and select **Reset and Debug**. The program will reset and run with the V+ debugging functions activated.

A green arrow indicates the current program line where the stepping function occurs.

## 7-9-3 System Monitor

You can graph the values of V+ variables and output those values to a log file in the System Monitor. This section provides the procedure to display V+ variables on the System Monitor during a simulation.

- 1 Select *RobotControlSettings* from a Multiview Explorer's device list.
- 2 Select **View– System Monitor** from the main menu.  
System Monitor Tab Page appears to display registered V+ variables.

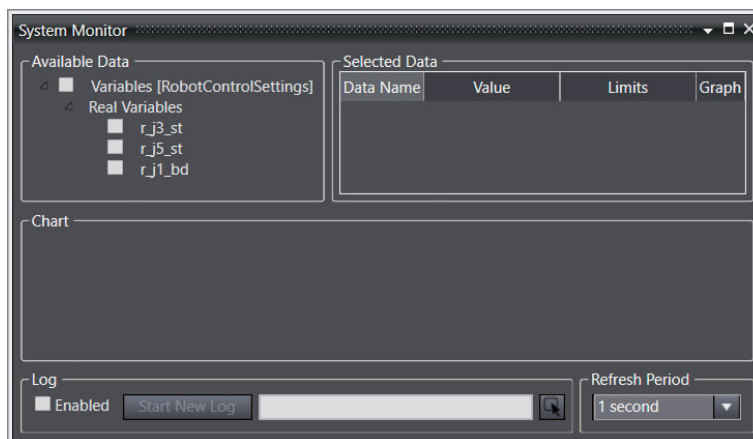

- 3 Check a variable you want to monitor in the **Available Data** area. Then, check the **Graph** box in the **Selected Data** area.  
Values of the variable are plotted on a graph.



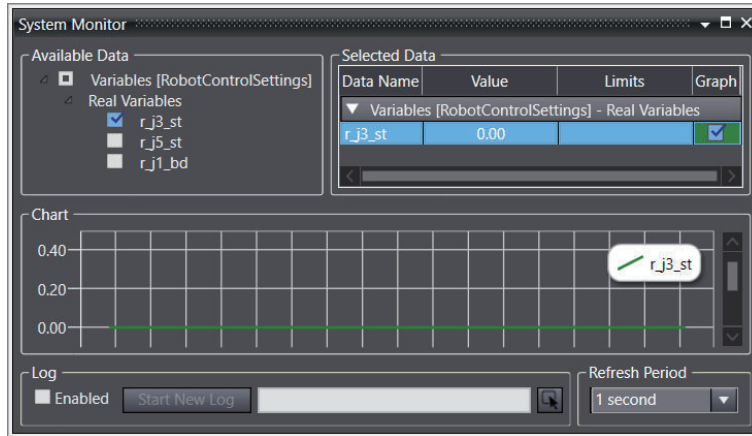

- 4** Select the folder in which to save a log in the **Log** area and check the Enabled box. Then click the **Start New Log** button.

A text file that contains variable values will be created in the designated folder.

## 7-10 Transferring V+ Programs and V+ Variables

The Sysmac Studio transfers V+ Programs and V+ Variables when a Simulator connection is established in Emulation Mode, or when the Controller performs synchronized or all-data transfer when an online connection is established with the physical Controller.

You can use the procedures for checking the V+ memory, synchronization, writing data to the V+ memory, and getting data from the V+ memory to check if the V+ Programs and V+ Variables in the project differ from those in the physical Controller or V+ emulator and then synchronize them.

### 7-10-1 Checking the V+ Memory

Use the following procedure to compare the V+ Programs and V+ Variables in the project with those in the physical Controller or V+ emulator. If there are differences, an icon that indicates the presence of differences is displayed to the left of the item in the Multiview Explorer.

- 1 Click the Check V+ Memory button in the toolbar.



If there are differences, an icon that indicates the presence of differences is displayed next to V+ Modules and V+ Variables in the Multiview Explorer.

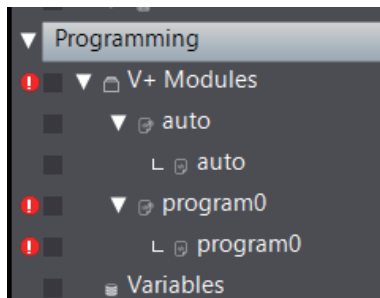

### 7-10-2 Synchronization

Use the following procedure to compare the V+ Programs and V+ Variables in the project with those in the physical Controller or V+ emulator and display in a list form whether there are differences. If there is any difference in the V+ Programs, you can check the details.

You can also specify the target and direction of transfer and write or read the V+ Programs and V+ Variables to the V+ memory all at once.

## ! WARNING

Check operations of the created user programs, data, and setting values carefully before proceeding to normal operation.



## ! WARNING

Ensure the enough safety before making any changes that may affect the operation of the robot.



- 1 Click the Synchronize button in the toolbar.

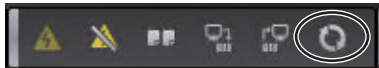

A list of V+ Programs and V+ Variables is displayed.

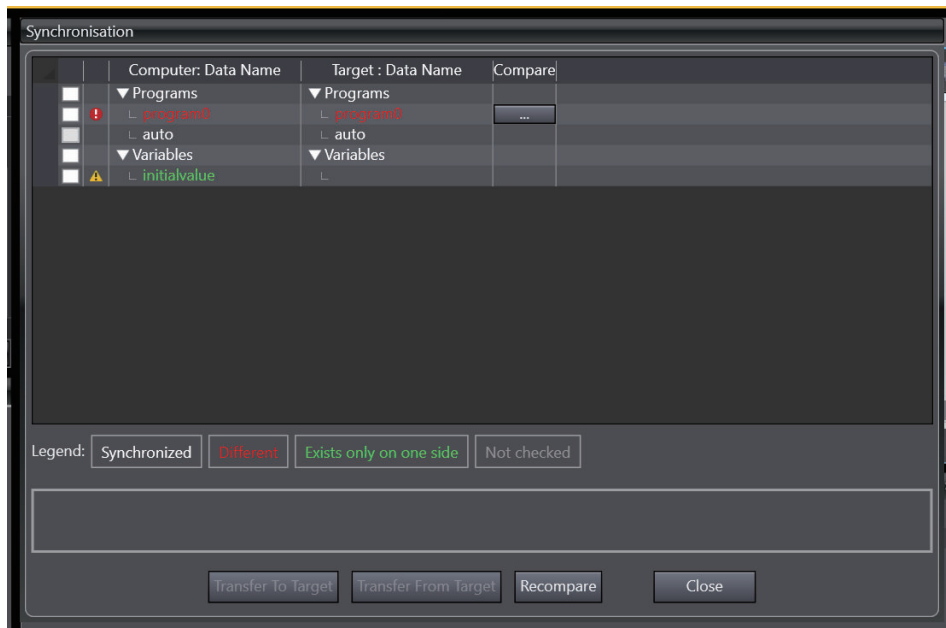

The results of the comparison are displayed as shown below. For V+ Programs, you can display the detailed comparison window.

Legend	Description	Detailed comparison
Synchronized (No differences)	The content of the project matches that of the V+ memory.	---
Different	The programs and variables in the project differ from those in the V+ memory.	For V+ Programs, you can display the detailed comparison window.
Data missing	Data is present in either the project or V+ memory.	You cannot display the detailed comparison window.

- 2 Click the  button.

The detailed comparison window for the V+ Program is displayed. The V+ Program in the project is shown on the left, while the V+ Program in the V+ memory is shown on the right.

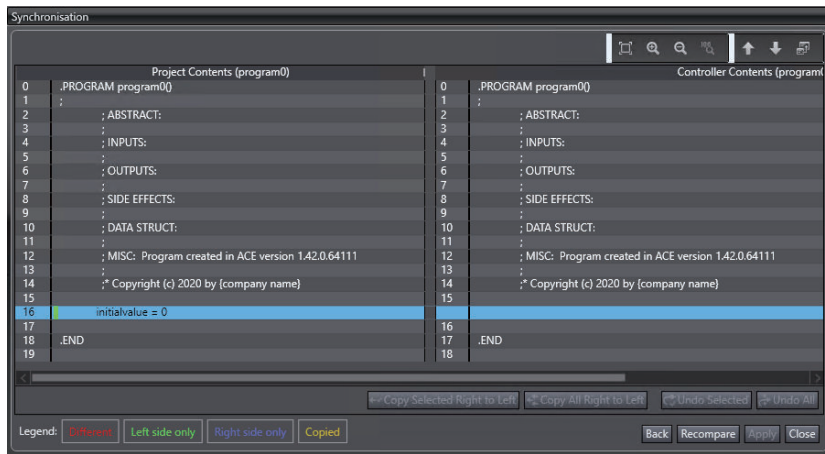

### Additional Information

You cannot copy the V+ Program from the left to the right and vice versa, or merge them.

- 3 Click the differences in the V+ Programs and click the **Close** button.
- 4 Select the data to transfer.

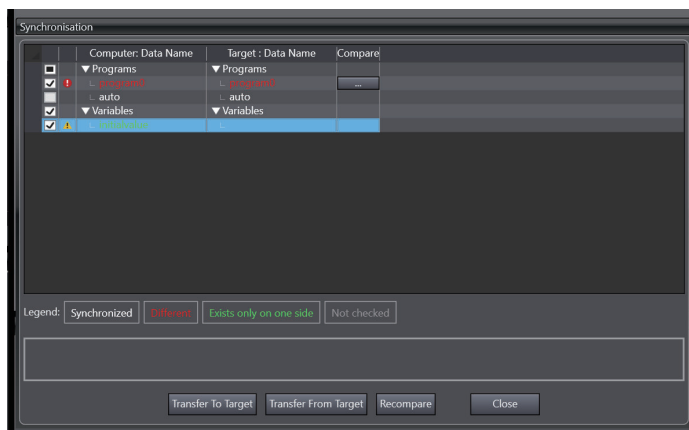

- 5 Click the **Transfer to Target** or **Transfer from Target** button. Here, click the **Transfer to Target** button.

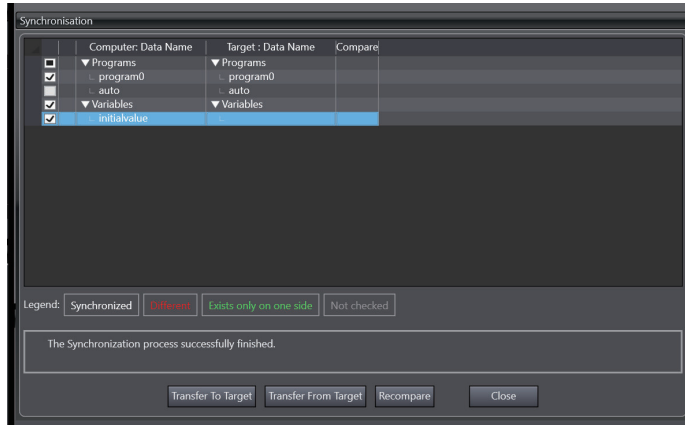

- 6** If you click the **Transfer to Target** button in Step 5, the **Push to V+ Memory** dialog box appears after the transfer of the selected project data to V+ memory is completed.

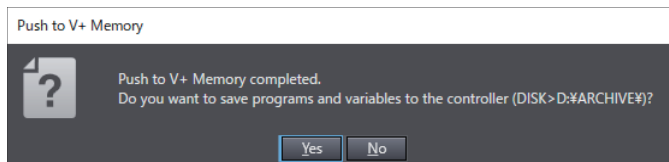

To save the programs and variables in the Controller's non-volatile memory (SD Memory Card), click the **Yes** button.

The programs and variables are saved in the Controller's non-volatile memory (SD Memory Card).

- 7** When a message that shows the completion of save processing is displayed, click the **OK** button.

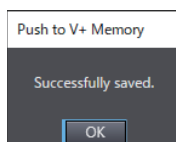

### Precautions for Correct Use





- A V+ variable that declared in a V+ program may not agree when the program synchronized. To resolve the variable discrepancy, execute *Push to V+ Memory* or *Pull from V+ Memory*. Or, define V+ variables in the V+ Variable Editor.  
When a V+ variable is declared in a V+ program, execution of the declaration line generates dynamically the variable on the memory, then updates the V+ variable list on the V+ memory. It makes a difference between the V+ variable list in the V+ Variable Editor, which defined in a Sysmac Studio project, and causes a discrepancy at a synchronization.
- If you write a value to the V+ memory but do not save it to the non-volatile memory (SD Memory Card), the robot system may operate unintentionally when the power supply is cycled because it reads the unrenewed data from the non-volatile memory. Refer to **Additional Information** below as needed to configure it so that the data is saved to the non-volatile memory (SD Memory Card).

**Additional Information**

To display the **Push to V+ Memory** dialog box in Step 6, you need to select the **Save Programs and Variables on Controller when project is saved (DISK>D:\ARCHIVE\)** check box in the **Save Configuration** tab page. This setting enables you to save the programs and variables to the Controller's non-volatile memory (SD Memory Card). Refer to *5-5-2 Save Configuration* on page 5-21 for details.

**7-10-3 Writing Data to the V+ Memory**

Use the following procedure to write V+ Programs and V+ Variables to the V+ memory. You can use the procedure only when the V+ Programs and V+ Variables in the project differ from those in the physical Controller or V+ emulator.

 <b>WARNING</b>	
Check operations of the created user programs, data, and setting values carefully before proceeding to normal operation.	
 <b>WARNING</b>	
Ensure the enough safety before making any changes that may affect the operation of the robot.	

- 1 Click the Push to V+ Memory button in the toolbar.



A progress bar is displayed. When writing is completed, the progress bar disappears. Simultaneously, the icon that indicates the presence of differences disappears.

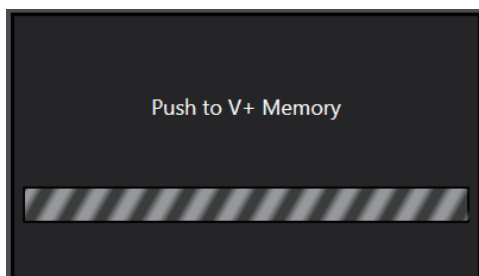

- 2 When writing to the V+ memory is completed, a message is displayed to confirm whether you save the programs and variables to the Controller's non-volatile memory (SD Memory Card).

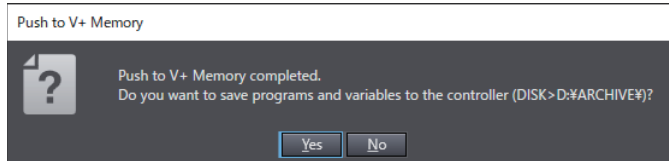

To save the programs and variables in the Controller's non-volatile memory (SD Memory Card), click the **Yes** button.

- 3** When a message that shows the completion of save processing is displayed, click the **OK** button.

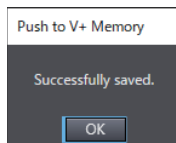

### Precautions for Correct Use

If you edit and write the data to the V+ memory but do not save it to the non-volatile memory (SD Memory Card), the Robot Integrated CPU Unit may cause unexpected behavior when the power supply is cycled since it reads the data before the edit from the non-volatile memory. Refer to **Additional Information** below as needed to configure it so that the data is saved to the non-volatile memory (SD Memory Card).



### Additional Information

To display the **Push to V+ Memory** dialog box in Step 2, you need to select the **Save Programs and Variables on Controller when project is saved (DISK>D:\ARCHIVE\)** check box in the **Save Configuration** tab page. This setting enables you to save the programs and variables to the Controller's non-volatile memory (SD Memory Card). Refer to *5-5-2 Save Configuration* on page 5-21 for details.

## 7-10-4 Getting Data from the V+ Memory

Use the following procedure to read V+ Programs and V+ Variables from the V+ memory all at once. You can use the procedure only when the V+ Programs and V+ Variables in the project differ from those in the physical Controller or V+ emulator.

- 1** Click the Pull from V+ Memory button in the toolbar.



A progress bar is displayed. When reading is completed, the progress bar disappears. Simultaneously, the icon that indicates the presence of differences disappears.

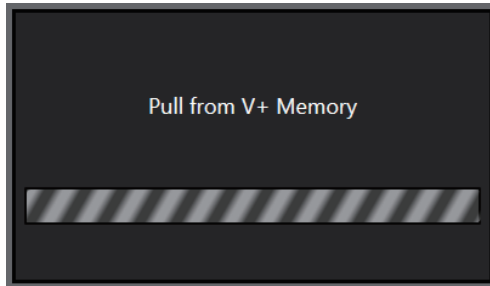

### 7-10-5 Notes on Transferring V+ Variables

When you transfer V+ variables, the behavior of the transfer function depends on the presence/absence of the variables in the Controller and PC. Before attempting a transfer, note the following points. The description below assumes that you selected **[Initial Value]** and **[Online Value]** column for **[Value]** column setting in **V+ Variables** in the Option dialog box.

#### Notes on Pushing to or Getting Data from the V+ Memory

- When You Click the Push to V+ Memory Button in the Toolbar



Presence/absence of V+ variables	Transfer behavior
Present in both the project and the Controller	The values in the <i>Initial Value</i> column are set as the Controller's variable values.
Present only in the Controller	The Controller's variables are deleted.
Present only in the project	New variables are added to the Controller and the values in the <i>Initial Value</i> column are set as the Controller's variable values.

- When You Click the Pull from V+ Memory Button in the Toolbar

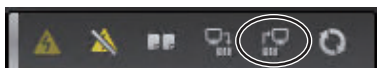

Presence/absence of V+ variables	Transfer behavior
Present in both the project and the Controller	There is no change in the variables.
Present only in the Controller	New variables are added to the project and the Controller's values are set in the <i>Initial Value</i> column.
Present only in the project	The project's variables are deleted.



## Notes on Synchronizing Data

When you execute **Transfer to Target** or **Transfer from Target** in the Synchronization Window after clicking the **Synchronize** button in the toolbar, the transfer function acts as described in the table below.

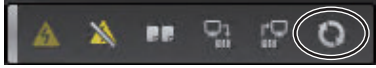

Presence/absence of V+ variables	Transfer behavior	
	During execution of Transfer to Target	During execution of Transfer from Target
Present in both the project and the Controller	The V+ variables are not transferred.	The V+ variables are not transferred.
Present only in the Controller	The Controller's variables are deleted.	New variables are added to the project and the Controller's values are set in the <i>Initial Value</i> column.
Present only in the project	New variables are added to the Controller and the values in the <i>Initial Value</i> column are set as the Controller's variable values.	The project's variables are deleted.



# 8

## Connection and Transfer to Physical Controller

This section describes the procedures for online connection to the Robot Integrated CPU Unit, data transfer, and checking the operations after the transfer.

---

<b>8-1</b>	<b>Connection and Transfer to the Robot Integrated CPU Unit.....</b>	<b>8-2</b>
8-1-1	Connection Type .....	8-2
8-1-2	Connection to the Robot Integrated CPU Unit .....	8-2
8-1-3	Transferring the Project.....	8-2
<b>8-2</b>	<b>Robot System Operation Authority Verification.....</b>	<b>8-8</b>
8-2-1	Robot Integrated CPU Unit Operation Authority.....	8-8
8-2-2	User Setting.....	8-8
8-2-3	Sign In/Sign Out .....	8-11
8-2-4	Operations when Both the Robot System Operation Authority Verification and the Controller Online Operation Authority Verification Are Set ....	8-13
<b>8-3</b>	<b>Checking Operation after Transfer .....</b>	<b>8-14</b>
8-3-1	Online Debugging.....	8-14
8-3-2	Robot Power Turned ON .....	8-17
8-3-3	Teaching .....	8-17
8-3-4	Online Editing.....	8-18

# 8-1 Connection and Transfer to the Robot Integrated CPU Unit

This section describes the procedures for connecting to the Robot Integrated CPU Unit and transferring data to it.

## 8-1-1 Connection Type

You must go online with the Controller or connect to the Simulator to communicate with them from the Sysmac Studio.

The Sysmac Studio supports the following online connections for different applications.

Connection type	Connection made to	Application
Online connection	Controller	To perform debugging, startup, or normal maintenance, the same project file as in the Controller is opened on the Sysmac Studio and then an online connection is made. An online connection is made based on the Communications Setup in the project file.
Simulator connection	Simulator	The Simulator is used to debug the program offline. The Communications Setup in the project file is not used. In addition to controller simulation debugging, you can perform the controller setting of the Robot Control Function Module, offline teaching, and V+ program offline debugging.

Refer to *7-5 Overview of Robot Integrated System Simulation* on page 7-39 for connecting to the Simulator and debugging operations.

## 8-1-2 Connection to the Robot Integrated CPU Unit

You can go online with the Robot Integrated CPU Unit in a project from the Sysmac Studio.

The connection methods, communication settings, and online connection operations are the same as for conventional Controllers. For operating method details, refer to the *Sysmac Studio Version 1 Operation Manual (Cat. No. W504)*.



### Additional Information

Writing and reading the controller settings in the robot control function modules, V+ programs, and V+ variables require online connection to the subdevice *RobotControlSettings*. Confirm the top of the Edit pane is yellow when selecting **RobotControlSettings** from a Multiview Explorer's device list.

If not, the connection with *RobotControlSettings* has been offline. Select the controller in the device list, then offline the controller and go online again.

## 8-1-3 Transferring the Project

Programs and the configuration and setup data in the Sysmac Studio are transferred to the Robot Integrated CPU Unit.

## Data stored in the Robot Integrated CPU Unit

Downloaded data from the Sysmac Studio to the Robot Integrated CPU Unit and the locations to store them are as follows.

Type of data	Storage locations	Reference
V+ programs, V+ variables, and controller settings of the Robot Control Function Module for the function to control robots	Non-volatile memory (SD Memory Card) and main memory	<i>NJ-series Robot Integrated CPU Unit User's Manual (Cat. No. O037)</i>
Settings and programs other than the above	Built-in non-volatile memory	<i>NJ/NX-series CPU Unit Software User's Manual (Cat. No. W501)</i>

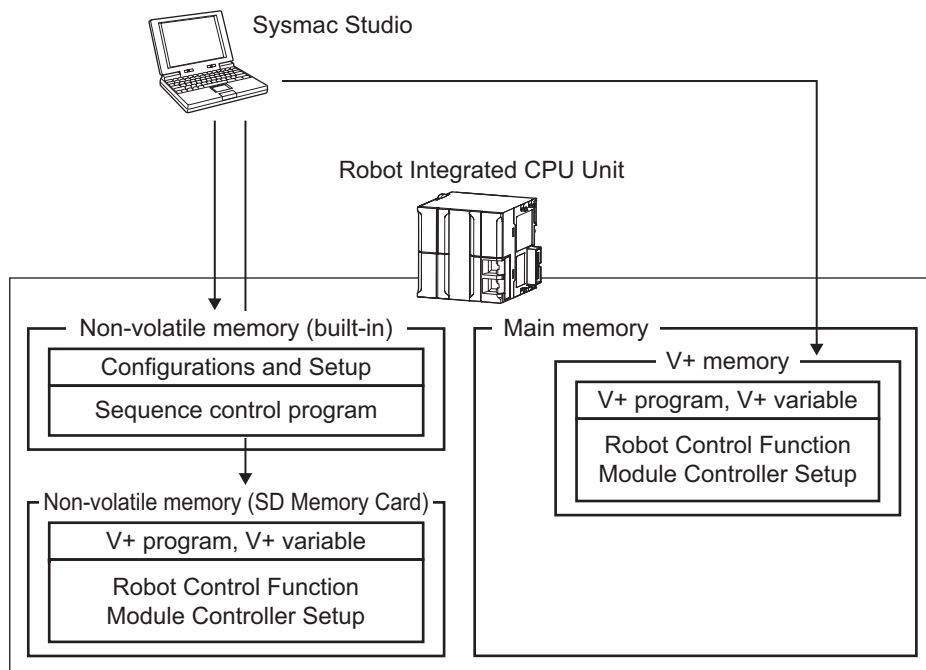

### Precautions for Correct Use

- Be sure to insert an SD Memory Card when using the Robot Control function for the Robot Integrated CPU Unit. If not, an error will occur when a synchronization is performed.
- Synchronization, Transfer to Controller, and Transfer from Controller are available only when the robot system operation authority is *Engineer*, and the controller's online operation authority is either of *Designer*, *Administrator*, or *Maintainer*. Refer to 8-2 *Robot System Operation Authority Verification* on page 8-8 for the information on verifying the robot system operation authority.

## Automatic Verification Procedure

- 1 Select the Robot Integrated CPU Unit from the device list in the Multiview Explorer.
- 2 Physically connect the computer to the Controller and then select **Online** from the **Controller** Menu.

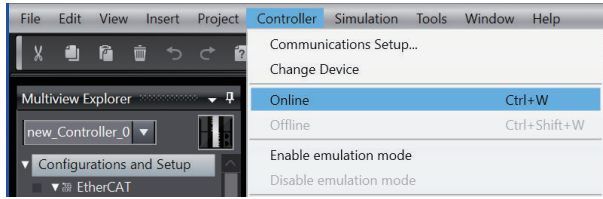

The Sysmac Studio goes online with the Controller.

### 3 Select **Synchronization** from the **Controller** Menu.

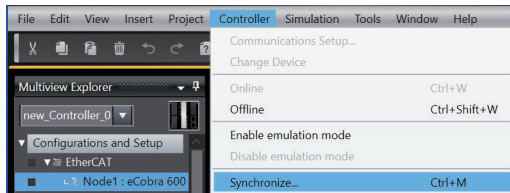

The Synchronization Window is displayed and verification of the user program and parameter settings between the Sysmac Studio and the Robot Integrated CPU Unit is started. When Synchronization is completed the Comparison Results Dialog Box is displayed.

Refer to *Sysmac Studio Version 1 Operation Manual (Cat. No. W504)* for the detailed Comparison Results Dialog Box.



#### Precautions for Correct Use

The robot specification file, V+ program, and V+ variables are exempt from comparison. Even if either of robot specification file, V+ program, or V+ variable is inconsistent, the data will not be transmitted from your PC to the Robot Integrated CPU Unit when the Comparison Results Dialog box shows *Match*. To transmit the data, execute *Push to V+ Memory* or *Pull from V+ Memory*. Refer to 7-10-3 *Writing Data to the V+ Memory* on page 7-68 and 7-10-4 *Getting Data from the V+ Memory* on page 7-69 for details. When the Comparison Results Dialog box shows *Not match*, a transfer operation sends the data from the PC to the Robot Integrated CPU Unit automatically.

## Data Transfer (from Computer to Controller)

If there are any differences in the data between the computer and the Controller, the following dialog box is displayed after the automatic verification.

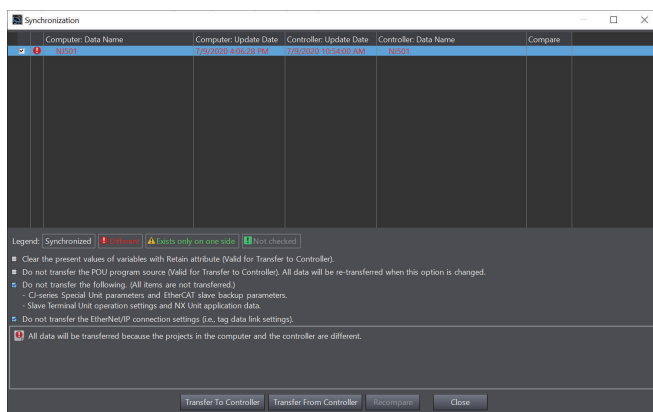

When data is transferred from the computer to the Robot Integrated CPU Unit, follow the below procedures.

- 1 Select the items to check for synchronization. The transfer process depends on which of these items are selected. Refer to *Sysmac Studio Version 1 Operation Manual (Cat. No. W504)* for details.
- 2 Select the items to transfer from the verification results in the Details Area of the Synchronization Window. And then click the **Transfer To Controller** button (download).  
If EtherCAT and Robot Control Setup are not selected in the list of the items to transfer, the following dialog box is displayed.

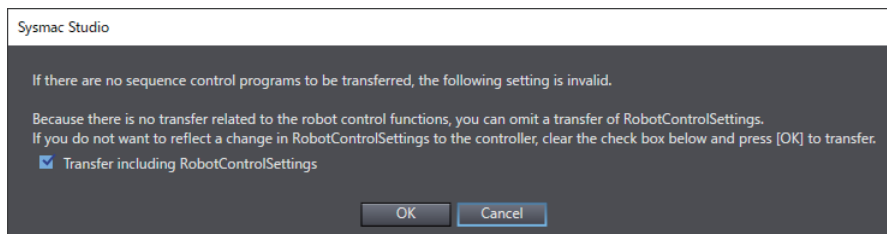

If sequence control programs are not selected as the items to transfer, this setting is invalid. To transfer RobotControlSettings only, use the synchronization function. Refer to 7-10-2 *Synchronization* on page 7-64 for synchronizing RobotControlSettings.

- 3 Select the **Transfer including RobotControlSettings** check box as needed, and then click the **OK** button.  
If you transfer the data including RobotControlSettings, the following message is displayed.

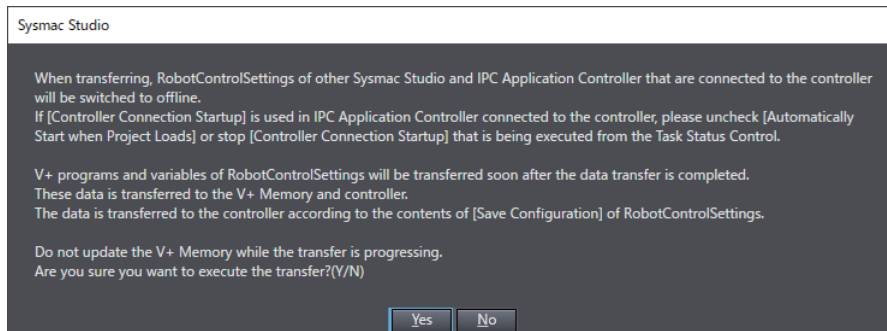

- 4 Click the **Yes** button to transfer the data.  
The following message is displayed.

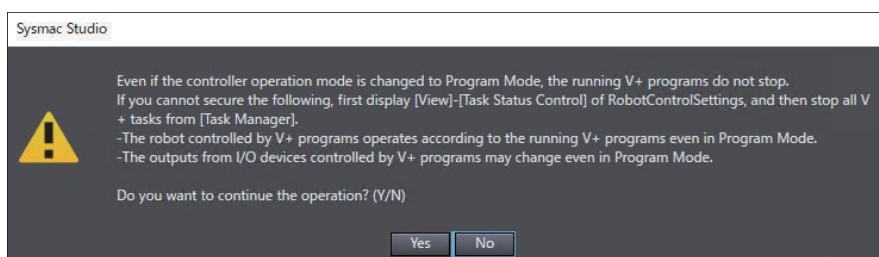

Check the current operating system status and then click the **Yes** button.

Depends on the controller status, the following message may be displayed.

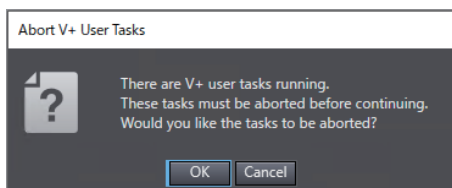

Check the operation status and then click the **OK** button.

- 5** The dialog box, that the synchronization is in progress, is displayed.

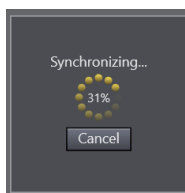

- 6** Click the **Close** button to close the Synchronization Window when the transferring is completed.



#### Precautions for Correct Use

If any of the following events occurs in the Robot Integrated CPU Unit after completion of the transfer, you must match the configured V+ versions of the Robot Integrated CPU Unit and robots. Refer to *10-6 V+ Version Configuration* on page 10-9 for details.

Event name	Event code	Description
Inconsistent Configured V+ Versions	37C30000 hex	An inconsistency was detected between the configured V+ versions of the CPU Unit and OMRON robots.
Incorrect Configured V+ Version	37C40000 hex	The CPU Unit or an OMRON robot has no configured V+ version.

## Data Transfer (from Controller to Computer)

After the automatic verification, when data is transferred from the Robot Integrated CPU Unit to the computer, follow the below procedures.

- 1** Select the items to check for synchronization.
- 2** Select the items to transfer from the verification results in the Details Area of the Synchronization Window. And then click the **Transfer From Controller** button (upload).  
The following message is displayed.



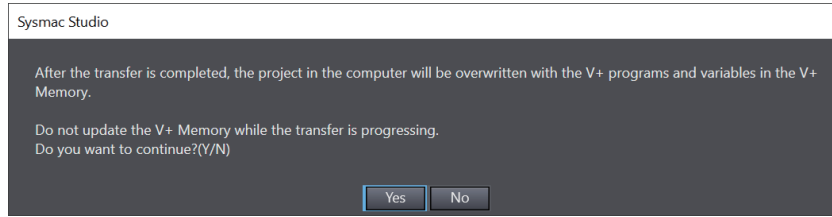

- 3 Click the **Yes** button to transfer the data.  
The dialog box, that the synchronization is in progress, is displayed.

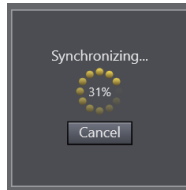

- 4 Click the **Close** button to close the Synchronization Window when the transferring is completed.

## 8-2 Robot System Operation Authority Verification

The robot system operation authority verification is a function, that restricts operations and displays, of robot settings and programs, in the Sysmac Studio, in order to protect assets and prevent incorrect operation.

### 8-2-1 Robot Integrated CPU Unit Operation Authority

The Robot Control System has functions that set the operation authority, for the settings/programs related to the robot, even when offline or during simulation debugging and prevent incorrect setting changes, in addition to the online operation authority verification function, of the conventional Sysmac Studio. The function is called the robot system operation authority verification.

By registering the user name and password in the project, it becomes possible to restrict the use of the data under the Robot Integrated CPU subdevice *RobotControlSettings* based on the set authority. The authority is classified by access levels, and there are the following types.

Access Levels	Restrictions on use
Engineer	No restrictions on use
Technician	The following functions and operations cannot be used. <ul style="list-style-type: none"> <li>• Adding or editing V+ programs</li> <li>• Robot controller setting display or change</li> <li>• Synchronization, transferring</li> <li>• Backup and restore</li> <li>• V+ Edit mode</li> <li>• Such as user management</li> </ul>
Operator	In addition to the Technician's restrictions, the following functions and operations cannot be used. <ul style="list-style-type: none"> <li>• Setting up end-effector</li> <li>• Using Monitor Window</li> <li>• Save Configuration display</li> </ul>



#### Precautions for Correct Use

The robot system operation authority verification information is not transferred to the controller. Thus, even if you upload a project from the controller, the robot system operation authority verification settings are not restored. When operating the project data of the device controller as the master, do not use the robot system operation authority verification. Use only online operation authority verification for the conventional controller data. Refer to the *Sysmac Studio Version 1 Operation Manual (Cat. No. W504)* for the online operation authority verification function of the Controller.

### 8-2-2 User Setting

Set user names and access levels in order to use the robot system operation authority verification function. And set a password for each user.



### Additional Information

User setting can be used only when a project is opened by a user whose access level is *Engineer*.

- 1 Select the *RobotControlSettings* from the device list in the Multiview Explorer.

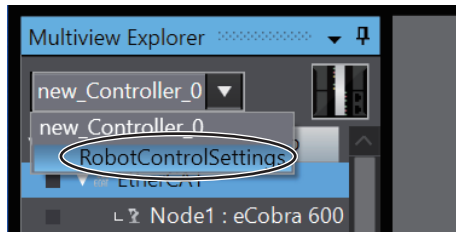

- 2 Select **File – Edit Users** from the main menu. The **User Manager** dialog box is displayed.

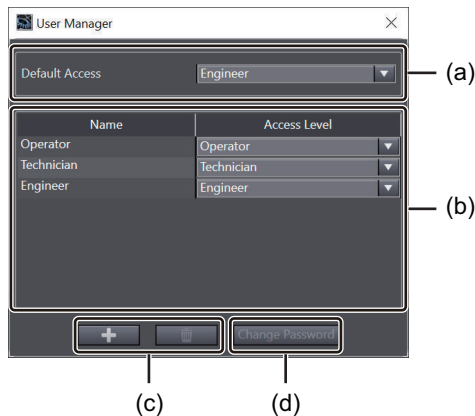

	Item	Description
(a)	Default Access	Set the access level when you are signed out.
(b)	Registered user	The registered user name and access level are displayed. By default, Operator, Technician, and Engineer are registered.
(c)	The <b>Add/Delete</b> buttons	Add/ delete a user.
(d)	The <b>Change Password</b> button	Change the password of the selected user.

- 3 Click the **Add** button.

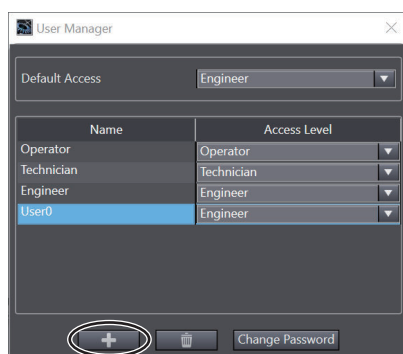

The name User0 is newly added.

- 4 Double-click the name and change it to any name.

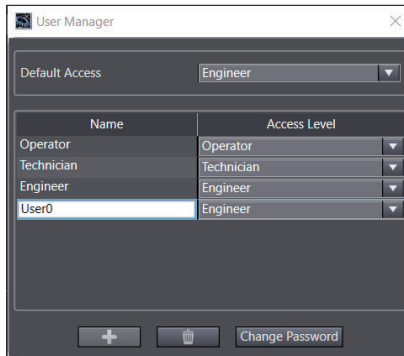

- 5 Select the authority to set in Access Level.

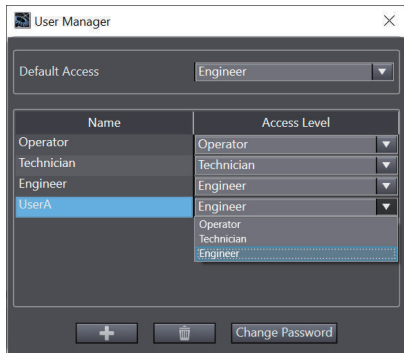

- 6 Click the **Change password** button to set the password.

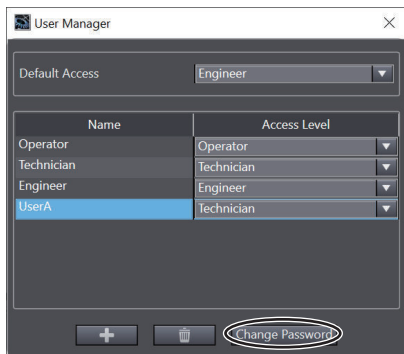

The **Change password** dialog box is displayed.

- 7 Enter the new password and click the **OK** button.

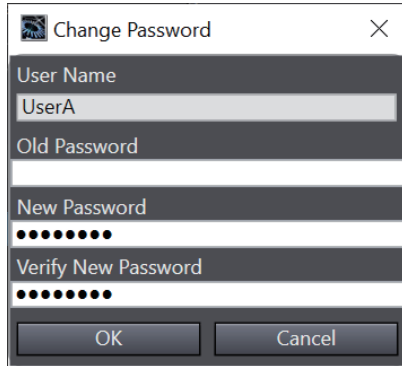

The 'Change Password' dialog box contains the following fields and buttons:

- User Name:** A text input field containing 'UserA'.
- Old Password:** An empty text input field.
- New Password:** A text input field with seven black dots representing a masked password.
- Verify New Password:** A text input field with seven black dots representing a masked password.
- Buttons:** 'OK' and 'Cancel' buttons at the bottom.

It is not necessary to fill in the **Old Password** box at a new registration.

- 8 Click the **Close** button in the upper right corner of the **User Manager** dialog box to close it.

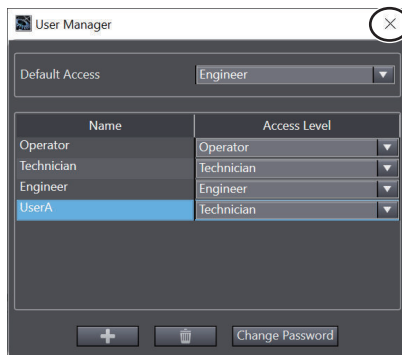

The 'User Manager' dialog box features a 'Default Access' dropdown menu set to 'Engineer'. Below it is a table with columns 'Name' and 'Access Level':

Name	Access Level
Operator	Operator
Technician	Technician
Engineer	Engineer
UserA	Technician

At the bottom of the dialog are three buttons: '+', a trash icon, and 'Change Password'. A close button (X) is circled in the top right corner.



#### Additional Information

To use the robot system operation authority verification function correctly, set each password for all names (user names). If the password is not set, a user, who do not need verification will remain. Even that user can also use functions based on the granted access level.

### 8-2-3 Sign In/Sign Out

This section describes Sign In/Sign Out to enable the robot system operation authority verification function.

#### Sign In

Select the registered user name and enter the password. When it is properly authenticated, the access level operations, which is set in the user edit function, can be performed.

- 1 Select the *RobotControl/Settings* from the device list in the Multiview Explorer.

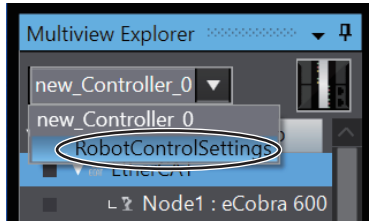

- 2 Select **File – Sign In** from the main menu.

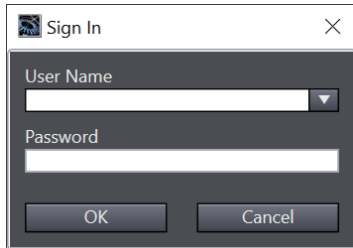

The **Sign In** dialog box is displayed.

- 3 Select the User Name, enter the Password, and click the **OK** button.

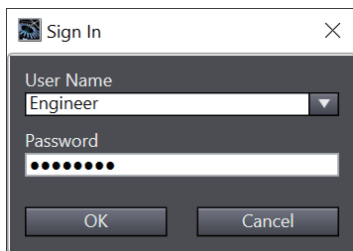

When it is properly authenticated, the dialog box is closed. And the access level operations of the selected user name can be performed.

## Sign Out

Perform transition from the sign-in state to the authorities set in the default access of the **Edit User** dialog box.

- 1 Select the *RobotControlSettings* in the device list in the Multiview Explorer.

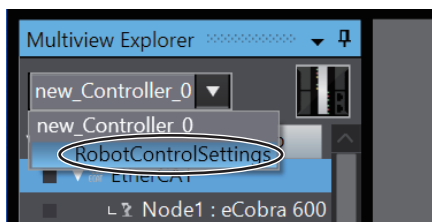

- 2 Select **File – Sign Out** from the main menu.  
The Access Level of the Status Bar becomes the level set by default access.

[Emulation Mode] Access Level: Engineer

### 8-2-4 Operations when Both the Robot System Operation Authority Verification and the Controller Online Operation Authority Verification Are Set

The robot system operation authority verification and the Controller online operation authority verification can be set and operated at the same time. Depending on functions to be operated and the online/offline status, the following two operations will be performed.

Operation target function	Online/Offline	Operation
Controller online function	Only online	Operation based on Controller online operation authority verification
Robot setting/ programming/ debugging function	Offline/Online	Operation based on robot system operation authority verification

However, the following functions will run when both Robot System Operation Authority Verification and Controller Online Operation Authority Verification are admitted.

Function	Robot System Operation Authority	Controller Online Operation Authority
V+ Edit mode	Engineer	Administrator or Designer
Synchronization	Engineer	Administrator, Designer, or Maintainer
Transfer To Controller/Transfer From Controller	Engineer	Administrator, Designer, or Maintainer
Controller Backup/Controller Restore	Engineer	Administrator, Designer, or Maintainer
Clear All Memory	Engineer	Administrator

## 8-3 Checking Operation after Transfer

After transferring the data to the Robot Integrated CPU Unit, check the robot system operations.

### 8-3-1 Online Debugging

Online debugging is performed for the Robot Integrated CPU Unit programs and robot settings.

Object	Description
Robot Integrated CPU Unit program	Debugs the V+ program and sequence control program transferred to the Robot Integrated CPU Unit.
Robot setting	Directly changes the setting data of the robot and tunes the robot operation.

Refer to *Sysmac Studio Version 1 Operation Manual (Cat. No. W504)* for the online debugging operation methods of the sequence control program.

 **WARNING**

Check operations of the created user programs, data, and setting values carefully before proceeding to normal operation.



 **WARNING**

Ensure the enough safety before making any changes that may affect the operation of the robot.





#### Precautions for Correct Use

When you change the controller's operation mode while debugging the sequence control program, the following message will be displayed.

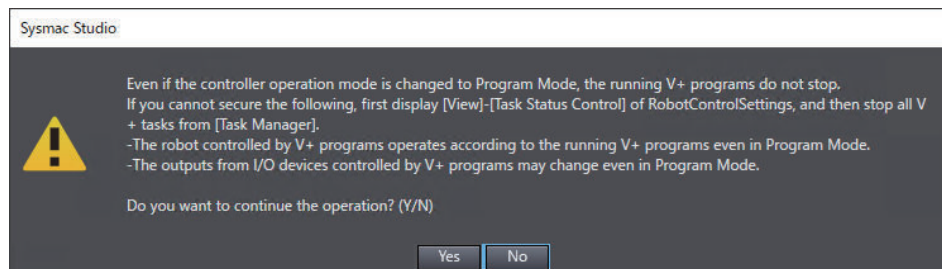

Check that the equipment is not affected before changing the operation mode of the controller.





### Additional Information

A sequence control program and a V+ program or shape script can be debugged at the same time.

While data tracing and debugging the sequence control program, you can switch the device to RobotControlSettings or Application Manager to debug a V+ program or shape script.

## V+ Program Online Debugging

The V+ program online debugging enables the following operations.

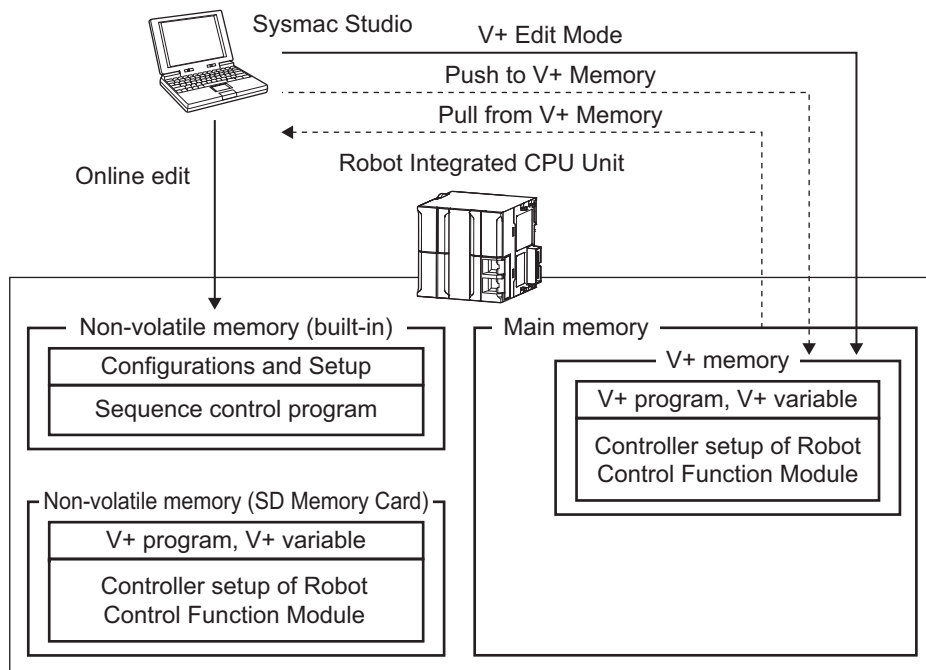

Function	Description	Reference
Online edit	Edits directly to the sequence control program in the built-in non-volatile memory.	<i>Sysmac Studio Version 1 Operation Manual (Cat. No. W504)</i>
V+ Edit Mode	Edits directly to the V+ program in the main memory.	<i>V+ Edit Mode</i> on page 8-18
Push to V+ Memory	Transfers the V+ program and V+ variables on the Sysmac Studio to the main memory.	<i>7-10-3 Writing Data to the V+ Memory</i> on page 7-68
Pull from V+ Memory	Transfers the V+ program in the main memory to the Sysmac Studio.	<i>7-10-4 Getting Data from the V+ Memory</i> on page 7-69
Check V+ Memory	Compares the V+ program and V+ variables in the main memory and the V+ program on the Sysmac Studio.	<i>7-10-1 Checking the V+ Memory</i> on page 7-64

### ● Difference in V+ Program Storage Memory

The V+ program is stored in V+ memory and non-volatile memory (SD Memory Card) in the Robot Integrated CPU Unit.

The memory to which data is written differs depending on the changes made to the V+ program and operations performed in the Sysmac Studio. Before attempting each operation, note the following points.

		Operations in the Sysmac Studio				
		<b>Robot Integrated CPU Unit</b> operation from the device list	<b>RobotControlSettings</b> operation from the device list			Executing <b>Save</b> from the <b>File</b> menu
		Executing <b>Transfer To Controller</b> from the <b>Synchronization</b> window	Executing <b>Transfer to Target</b> from the <b>Synchronization</b> window	Executing <b>Push to V+ Memory</b>	Exiting the V+ Edit mode	
<b>Changes to the V+ program</b>	Adding or renaming a V+ module* <sup>1</sup>					
	Modifying a V+ module program	<ul style="list-style-type: none"> <li>Writing the data to the V+ memory</li> <li>Writing the data to the non-volatile memory</li> </ul>	<ul style="list-style-type: none"> <li>Writing the data to the V+ memory</li> <li>Writing the data to the non-volatile memory*<sup>2</sup></li> </ul>	<ul style="list-style-type: none"> <li>Writing the data to the V+ memory</li> <li>Writing the data to the non-volatile memory*<sup>2</sup></li> </ul>	<ul style="list-style-type: none"> <li>Writing the data to the V+ memory</li> <li>Writing the data to the non-volatile memory</li> </ul>	<ul style="list-style-type: none"> <li>Writing the data to the non-volatile memory</li> </ul>
	Changing a value in the <i>Initial Value</i> column offline or in V+ Edit mode in the V+ variable table					
	Changing a value in the <i>Online Value</i> column online in the V+ variable table	Immediately writing the data to the V+ memory regardless of the operation				

\*1. To automatically load the added or changed V+ module into the V+ memory by cycling the power supply to the Robot Integrated CPU Unit, use the following procedure. The procedure should be performed before you perform *Operations in the Sysmac Studio* after making *Changes to the V+ program*, as shown in the table above.

- Under **Configurations and Setup** in the Multiview Explorer, double-click **Save Configuration**, then click the **Generate Auto Module** button in the **Save Configuration** tab page to update the Auto Module (AUTO.V2). This operation is required each time you add a new V+ module or rename a module. Refer to 5-5-2 *Save Configuration* on page 5-21 for generating an Auto Module.
- Under **Configurations and Setup** in the Multiview Explorer, double-click **Controller Settings** to open the **Controller Settings** tab page. Then, click the **Configure** button, select **Configure System Settings**, and select the **Auto Start** check box.  
Once you perform this operation online, the setting will remain effective after that time. Refer to 5-5-1 *Controller Settings* on page 5-9 for details on the Controller settings.

\*2. When writing to the V+ memory is completed, a message is displayed to confirm whether you write the data to the non-volatile memory subsequently. If you select **Yes**, the data will be written to the non-volatile memory. Refer to 7-10-2 *Synchronization* on page 7-64 for details on synchronization.

**Note 1.** *Non-volatile memory* in the table refers to the non-volatile memory (SD Memory Card).

**Note 2.** To execute writing the data to the non-volatile memory (SD Memory Card) under *RobotControlSettings operation from the device list* under *Operations in the Sysmac Studio* above, you need to select the **Save Programs and Variables on Controller when project is saved (DISK>D:\ARCHIVE)** check box in the **Save Configuration** tab page. Refer to 5-5-2 *Save Configuration* on page 5-21 for details.

## Robot Online Debugging

Each robot setting edit is performed to the robot directly through the Robot Integrated CPU Unit connected to online.

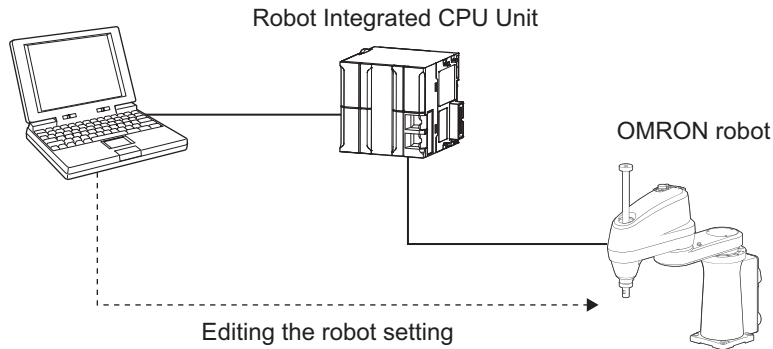

Refer to *5-6 Robot Settings* on page 5-24 for robot settings of online debugging targets.

### 8-3-2 Robot Power Turned ON

The power of a robot is turned ON and change the mode to confirm the operation.

For the robot power turned ON, operate the robot high power button connected to the robot and the teaching pendant, or V+ Jog Control function.

This section provides procedures by using V+ Jog Control function.

Refer to *Teaching Pendant T20 User's Manual (Cat. No. I601)* for procedures by using the teaching pendant.

## Robot Power Turned ON

- 1 Select **V+ Jog Control** from the **View** menu.  
The **V+ Jog Control** is displayed.
- 2 Select the target robot from the **Robot** menu, and then click the **Power** button.

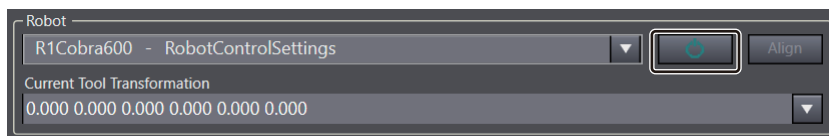

Robot high power button, connected to the robot, will flash during the time set in robot Safety Timeout. If you press the robot high power button during this time, the robot power will be supplied in an operable state.

Refer to *Configure Robots Safety Timeout* on page 5-17 for the time set of the robot Safety Timeout.

### 8-3-3 Teaching

Perform robot teaching. The position taught by an actual robot is adjusted based on the teaching data created in Emulation mode.

The V+ Jog Control function or the teaching pendant are used for the robot teaching. Refer to 7-7-3 *Teaching on V+ Jog Control Pane* on page 7-47 for operation procedures by using V+ Jog Control function. Refer to *Teaching Pendant T20 User's Manual (Cat. No. I601)* for procedures by using the teaching pendant.

### WARNING

Make sure that there are no hazards caused by robot's movements before operating the robot using the V+ Jog Control function.



### WARNING

Take a particular attention to the robot speed setting when you operate the robot using the V+ Jog Control function. Get ready to bring the robot to an emergency stop at an emergency. Make sure that there are no hazards caused by robot's movements before operating the robot.



## 8-3-4 Online Editing

Online editing allows you to edit programs, that are currently in operation. The sequence control program and the V+ program are targeted.

Here, procedures of the online editing of the V+ program are explained. Refer to the *Sysmac Studio Version 1 Operation Manual (Cat. No. W504)* for operation procedures of the online editing.

### WARNING

Check operations of the created user programs, data, and setting values carefully before proceeding to normal operation.



### WARNING

Ensure the enough safety before making any changes that may affect the operation of the robot.



## V+ Edit Mode

The V+ program online editing is performed in V+ Edit Mode. You can edit the V+ programs, V+ variables, and configurations and settings under the sub-device *RobotControl/Settings* in the V+ Edit Mode. Operation procedures of the V+ Edit Mode are explained.



### Precautions for Correct Use

- The V+ Edit Mode can be used when the robot system operation authority is *Engineer*, and the Controller online operation authority is *Designer* or *Administrator*. Refer to *8-2 Robot System Operation Authority Verification* on page 8-8 for the robot system operation authority verification.
- All V+ programs must match the Controller in order to start the V+ Edit Mode.
- In the V+ Edit mode, changes to the V+ program are immediately reflected to the controller. Secure the safety of the robot before making any changes.
- Do not connect more than one Sysmac Studio online to modify a V+ program in the V+ Edit Mode. It may result in an unintended modification.

### ● Starting the V+ Edit Mode

The operations in the V+ Program Editor are explained as an example.

- 1** Select the *RobotControl/Settings* from the device list in the Multiview Explorer.
- 2** Double-click the V+ Program in the Multiview Explorer.  
The V+ Program Editor Tab Page is displayed.

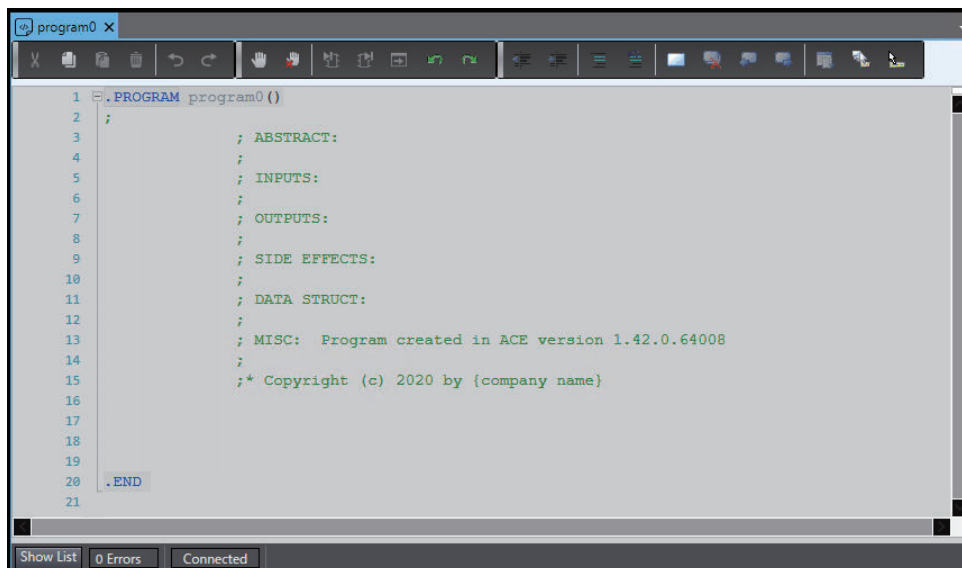

- 3** Select **V+ Edit Mode – Start** from the **Controller** Menu. Or, right-click on the V+ Program Editor Tab Page and select **V+ Edit Mode – Start**.  
The confirmation dialog box is displayed in order to start the V+ Edit Mode.

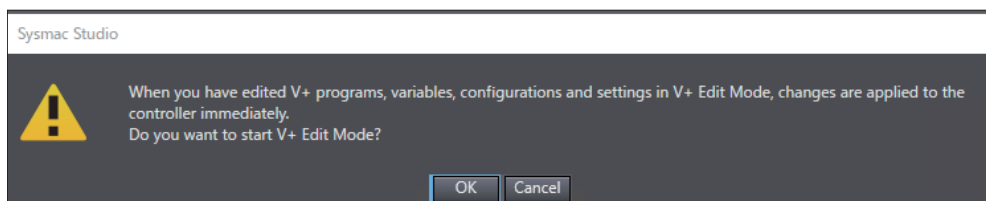

- 4** Click the **OK** button.  
The V+ Edit Mode is enabled and the V+ Program Editor Tab Page can be edited.

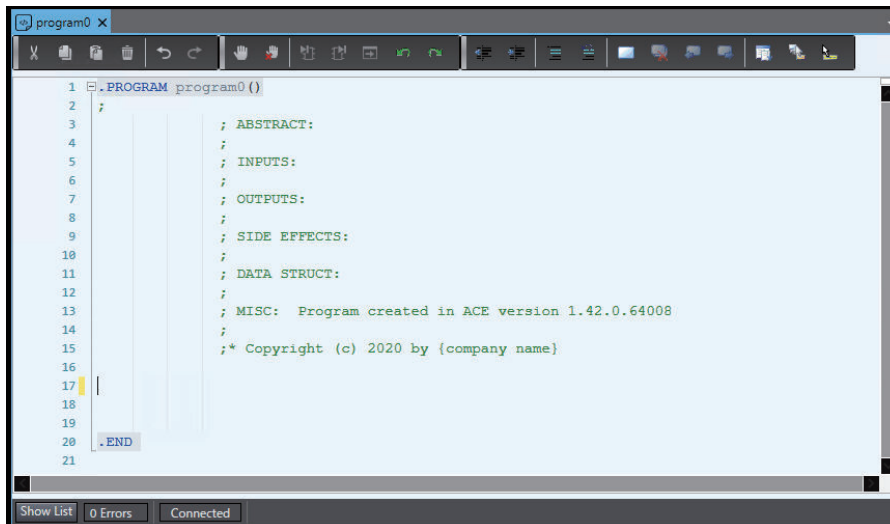

### Precautions for Correct Use

- When you have edited V+ programs, V+ variables, configurations and settings in the V+ Edit Mode, your edits are applied to the controller immediately. Confirm that the robot system operations will not be adversely affected before you perform the editing.
- Your edits are not automatically saved to the Controller's non-volatile memory (SD Memory Card). If you do not save the edit to the Controller's SD Memory Card, the robot system may operate unintentionally when the power supply is cycled because it reads the unrenewed data from the SD Memory Card. Press the Ctrl + S keys when *Save Programs and Variables on Controller* is enabled or click the **Save To Controller** button in the Save Configuration tab page to save the edited contents.

### ● Exiting the V+ Edit Mode

To exit the V+ Edit Mode, select **Controller – V+ Edit Mode – Exit** from the main menu. The robot system operations when exiting the V+ Edit Mode depend on the settings of the *Save Programs and Variables on Controller* in the Save Configuration tab page.

Refer to 5-5-2 *Save Configuration* on page 5-21 for the Save Configuration details.

- The *Save Programs and Variables on Controller* in the Save Configuration tab page is enabled. The following dialog box is displayed.

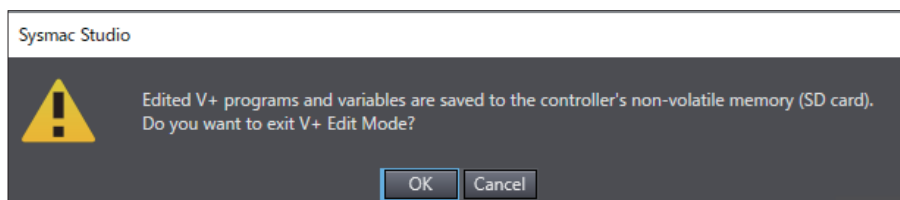

When you click the **OK** button, your edits are saved to the controller's non-volatile memory (SD card). And then the V+ Edit Mode is exited.

- The *Save Programs and Variables on Controller* in the Save Configuration tab page is disabled. The following dialog box is displayed.

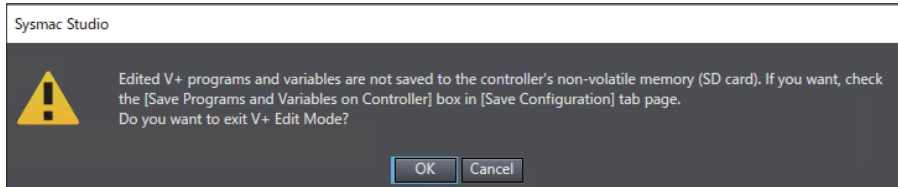

Click the **OK** button to exit the V+ Edit Mode. Your edits are not saved to the controller's non-volatile memory (SD card).



### **Precautions for Correct Use**

---

The V+ Edit Mode is automatically exited when the connection with the controller has gone off-line. Your edits are not saved to the controller's non-volatile memory (SD card) regardless of the setting of the *Save Programs and Variables on Controller* in the Save Configuration tab page.

---





# 9

## Maintenance

This section describes the confirmation methods of error and event that may occur in a robot integrated system and the data backup and restore methods for the Robot Integrated CPU Unit.

---

<b>9-1</b>	<b>Troubleshooting .....</b>	<b>9-2</b>
9-1-1	Outline of Troubleshooting and Maintenance Functions .....	9-2
9-1-2	Events in the Robot Integrated CPU Unit.....	9-2
<b>9-2</b>	<b>Backup and Restore .....</b>	<b>9-4</b>

# 9-1 Troubleshooting

This section provides an outline of the Sysmac Studio functions that can be used for troubleshooting and maintenance of a Robot Integrated System.

## 9-1-1 Outline of Troubleshooting and Maintenance Functions

The following is an outline of the troubleshooting and maintenance functions for a Robot Integrated System that consists of a Robot Integrated CPU Unit and an OMRON robot.

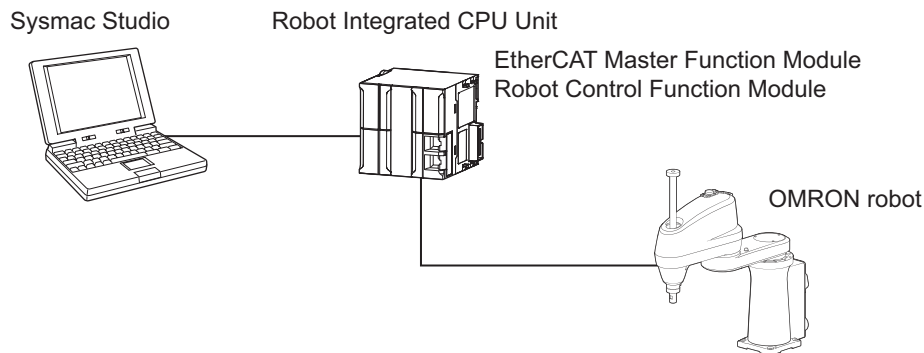

Application	Function	Target	Description	Reference
Checking for errors in troubleshooting	Troubleshooting	<ul style="list-style-type: none"> <li>EtherCAT Master Function Module</li> <li>Robot Control Function Module</li> </ul>	<p>You can use troubleshooting to check the errors that occurred in the Controller, display corrections for the errors, and clear the errors.</p> <p>You can check for errors in the EtherCAT Master Function Module and Robot Control Function Module.</p>	<i>9-1-2 Events in the Robot Integrated CPU Unit</i> on page 9-2
Finding the causes of troubles, adjustment	System Monitor	Robot Control Function Module	Monitor the parameters of the Robot Control Function Module in realtime.	<i>7-9-3 System Monitor</i> on page 7-62
	View eV+ Log	Robot Control Function Module	Display the history of processing in the Robot Control Function Module.	<i>View eV+ Log</i> on page 5-11
	Robot Hardware Diagnostics	OMRON robot	You can check the condition of the robot motor.	<i>10-2 Hardware Diagnostics</i> on page 10-3
	Robot Data Collection	OMRON robot	You can display and save the robot system data.	<i>10-3 Data Collection</i> on page 10-5
	Robot Motor Tuning	OMRON robot	You can send a square wave positioning command to a specified motor and observe the response.	<i>10-4 Motor Tuning</i> on page 10-7

## 9-1-2 Events in the Robot Integrated CPU Unit

Errors that occurred in a Robot Integrated System may be detected as events in the Robot Integrated CPU Unit. The Sysmac Studio allows you to check the events in the Robot Integrated CPU Unit.

- 1 Go online with the Robot Integrated CPU Unit and select **Troubleshooting** from the **Tools** menu.

The **Troubleshooting** dialog box is displayed.

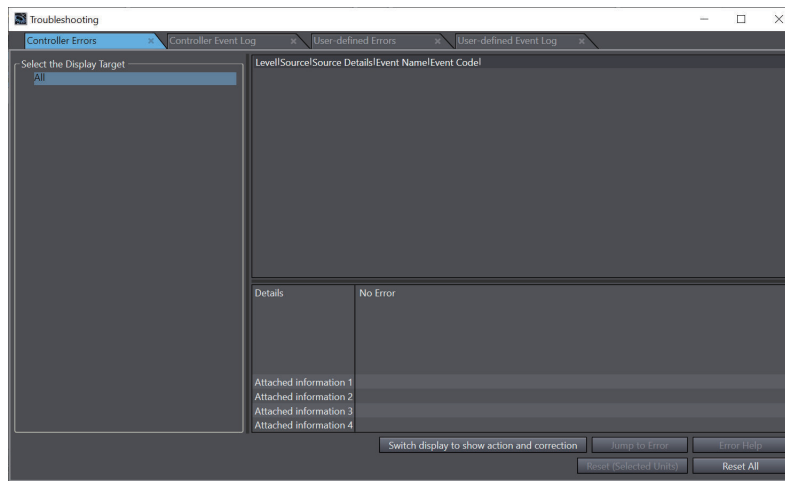

The current errors are displayed in the **Controller Errors** tab page.

- 2 Click the **Controller Event Logs** tab.

A log of the events that occurred in the past is displayed.

Check the source and cause of the errors and click the **Switch display to show action and correction** button to check the corrections.



#### Additional Information

- Refer to the *Sysmac Studio Version 1 Operation Manual (Cat. No. W504)* for details on the **Troubleshooting** dialog box.
- For events that occur in Robot Integrated CPU Units, refer to the *NJ-series Robot Integrated CPU Unit User's Manual (Cat. No. O037)* and the *NJ/NX-series Troubleshooting Manual (Cat. No. W503)*.

## 9-2 Backup and Restore

With the backup functions, you can back up, restore, and compare the user program and other data in the Robot Integrated CPU Unit to replace hardware, such as the CPU Unit, or to restore device data. The Sysmac Studio supports several backup functions as shown in the table below. This section describes the functions and restrictions that are specific to Robot Integrated CPU Units. Refer to the *Sysmac Studio Version 1 Operation Manual (Cat. No. W504)* for the basic use of each function.



### Precautions for Correct Use

- The equipment may perform an unexpected operation if an improper backup data is set when the backup data is restored to the unit. Check that the equipment is not affected before executing a transfer.
- Controller Backup and Controller Restore are available when the robot system operation authority is *Engineer*, and the controller's online operation authority is either of *Designer*, *Administrator*, or *Maintainer*. Refer to 8-2 *Robot System Operation Authority Verification* on page 8-8 for the information on verifying the robot system operation authority.

Function	Description	Functions and restrictions that are specific to Robot Integrated CPU Units
Controller Backup Functions	You can back up, restore, or compare all of the data in the Controller.	You can back up/restore V+ Programs and V+ Variables to/from an SD Memory Card. However, V+ Programs and V+ Variables in memory are not the target of backup and restore. Configured V+ versions are the target of backup and restore. After executing a restore, you must reset or restart the Controller to reflect the configured V+ version in the Controller.
SD Memory Card back-up	You can back up the data in the Controller to an SD Memory Card mounted in the Robot Integrated CPU Unit or compare the data in the Controller to the data in the SD Memory Card.	You can back up V+ Programs and V+ Variables to an SD Memory Card. However, V+ Programs and V+ Variables in memory are not the target of backup and restore. Configured V+ versions are the target of backup and restore. After executing a restore, you must reset or restart the Controller to reflect the configured V+ version in the Controller.
Variable and memory backup	You can back up and restore the contents of retained memory locations in the Controller.	There are no specific functions or restrictions.
Importing and exporting backup files	You can import backup files from <i>Controller backups</i> or <i>SD Memory Card backups</i> to projects on the Sysmac Studio or export data from projects on the Sysmac Studio to backup files.	Backup files can be imported, but cannot be exported.

# Other Functions

This section describes other functions as printing and hardware diagnostics.

---

<b>10-1 Printing</b> .....	<b>10-2</b>
10-1-1 Items You Can Print.....	10-2
<b>10-2 Hardware Diagnostics</b> .....	<b>10-3</b>
<b>10-3 Data Collection</b> .....	<b>10-5</b>
<b>10-4 Motor Tuning</b> .....	<b>10-7</b>
<b>10-5 Searching and Replacing</b> .....	<b>10-8</b>
10-5-1 Scope of Searching and Replacing and Setting Items .....	10-8
<b>10-6 V+ Version Configuration</b> .....	<b>10-9</b>
10-6-1 Checking V+ Versions .....	10-9
10-6-2 Renewing V+ Versions .....	10-11

# 10-1 Printing

---

This section describes the printing functions of the sub-device *RobotControlSetting*, which represents the settings for the Robot Control Function Module.

Refer to the *Sysmac Studio Version 1 Operation Manual (Cat. No. W504)* for the basic functions and specific procedures for printing.

## 10-1-1 Items You Can Print

You can print the following items. You can select the items to print.

- Controller Settings
- Save Configuration
- Robot Settings
- End-Effector
- V+ Program
- V+ Variables

## 10-2 Hardware Diagnostics

Hardware Diagnostics is used to check robot motor status when the Sysmac Studio goes online with the Robot Integrated CPU Unit. For example, when a robot's segmented display shows encoder error E2, it means encoder error on Motor 2. Hardware Diagnostics can be used to determine what Encoder Alarm Bit on Motor 2 is triggering the encoder error.

Select **Control – Hardware Diagnostics** in the **Robot Settings**. The **Hardware Diagnostics** dialog box is displayed.

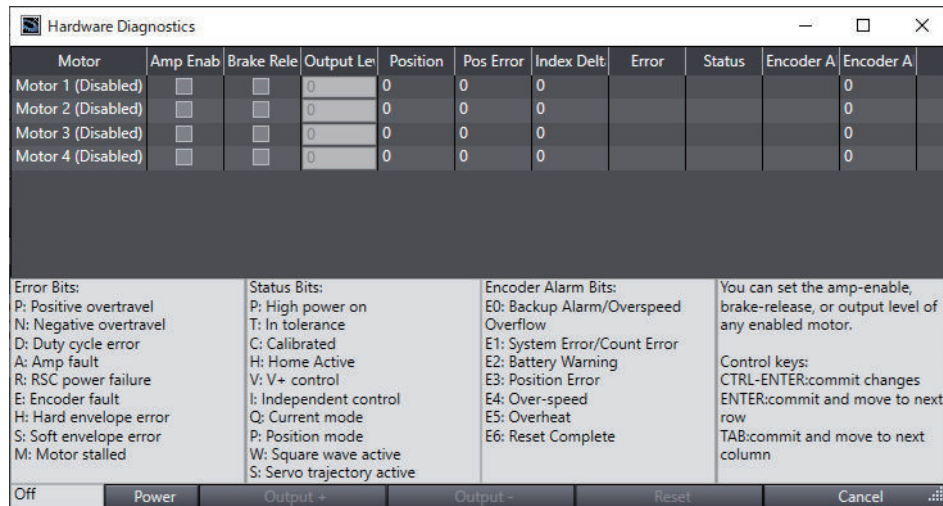

Item	Description
Amp Enable	Enables/disables an amplifier for the selected motor.
Brake Release	Enables/disables a brake release for the selected motor.
Output Level	Specifies a commanded torque, which is used to test the operation of the selected motor. The range is from -32767 to 32767.
Position	Displays the current position of the selected motor by encoder counts.
Pos Error	Displays the position error of the selected motor by encoder counts.
Index Delta	Displays a change from the previous latched zero index and the most recent latched zero index of the selected motor by encoder counts. Note that it is only useful with incremental encoders to verify zero index spacing and proper encoder readings.
Error	Displays the following error codes for the selected motor. P: Positive over-travel N: Negative over-travel D: Duty cycle error A: Amp fault R: RSC (Robot Signature Card) power failure E: Encoder fault H: Hard envelope error S: Soft envelope error M: Motor stalled

Item	Description
Status	Displays the following status codes for the selected motor. P: High power on T: In tolerance C: Calibrated H: Home sensor active V: V+ control I: Independent control Q: Current mode P: Position mode W: Square wave active S: Servo trajectory active
Reset	Resets any encoder errors for the selected motor.
Power	Toggles the high power. The current power state is shown in the status field.
Output + Output -	DAC output controls. Click the <b>Output +</b> button to increase the DAC output to the selected motor. Click the <b>Output -</b> button to decrease the DAC output to the selected motor.



## 10-3 Data Collection

You can log the robot system data by using the data collection function.

Data Collection can be used to view, store, and plot various robot system data while online with the Robot Integrated CPU Unit. You can acquire up to 8 data items to the memory limit of the controller's data buffer, at the maximum of 8 kHz sampling rate.

Select **Control – Data Collection** in the **Robot Settings**. The window shown below is displayed. The Data Collection function is not available in the EMULATION mode.

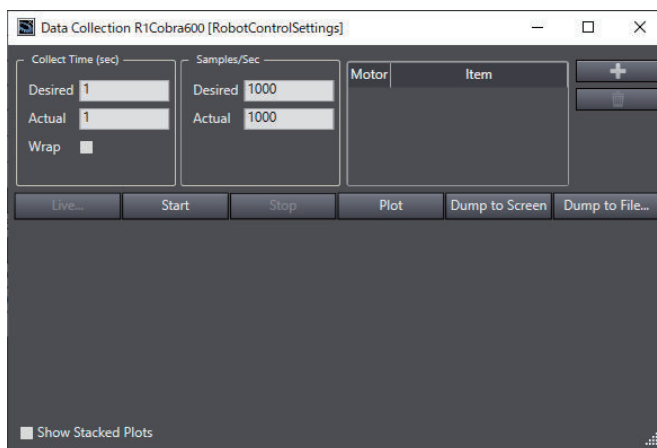

Item	Description
Collect Time (sec)	Specifies the data collection time in seconds. The default value is 1.
Samples/sec	Specifies the data collection frequency (samples/sec). The default value is 1000.
Add.../Remove	Add or remove motor items to examine with these buttons. Clicking the <b>Add</b> button will display the <b>Add Items to Collect</b> dialog box. <div data-bbox="464 1384 911 1688" data-label="Image"> </div>
Live	Displays a window that shows the real-time data being collected.
Start	Click this button to start a data collection. The data collection will continue until either the <b>Stop</b> button is clicked, or the specified data collecting time is up.
Stop	Click this button to stop a data collection. If the specified data collecting time has already passed, this button is disabled.
Plot	Click this button to plot the collected data. The progress bar appears while the data is being processed. After the processing has completed, the data is plotted on the graph located at the lower part of the <b>Data Collection</b> dialog box.

Item	Description
Dump to Screen	Displays the collected data in the Data Dump window in text-file format.
Dump to File...	Displays the <b>Save As</b> dialog box used for saving the collected data to a text file. You can display or edit the text file later.

## 10-4 Motor Tuning

Motor Tuning is used to send a square wave positioning command to the specified motor and observe the response for servo motor tuning purposes. Observing responses works same as Data Collection. Refer to *10-3 Data Collection* on page 10-5 for details.

Selecting **Motor Tuning** will display the following window. The Motor Tuning function is not available in the EMULATION mode.

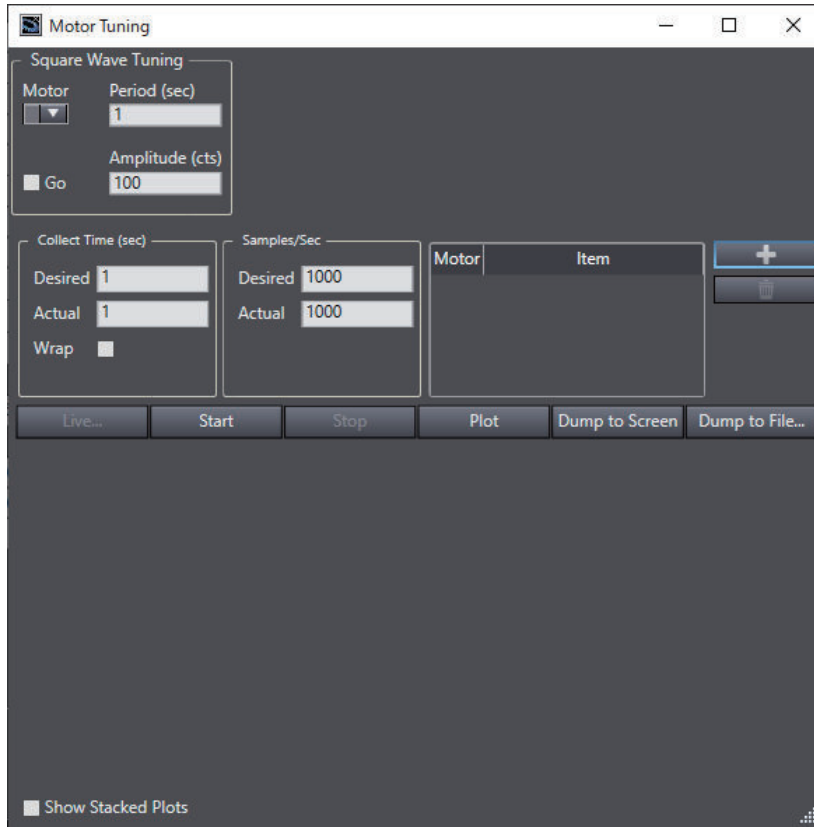

Item	Description
Motor	Specifies the motor that will receive the square wave positioning command.
Period (sec)	Specifies the length of square wave in seconds.
Amplitude (cts)	Specifies the amplitude of square wave in servo counts.
Go	Turns ON/OFF the square wave positioning command to the specified motor.

# 10-5 Searching and Replacing

This section describes the search and replace functions of the sub-device *RobotControlSettings*, which represents the settings for the Robot Control Function Module.

Refer to the *Sysmac Studio Version 1 Operation Manual (Cat. No. W504)* for the basic functions and specific procedures for searching and replacing.

## 10-5-1 Scope of Searching and Replacing and Setting Items

### Scope of Searching and Replacing

You can search and replace text strings that are displayed in the V+ program editor.

### Setting Items

The settings in the Search and Replace pane are explained below.

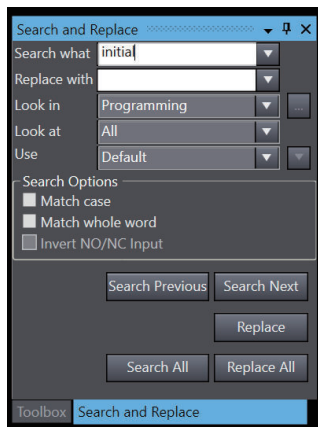

Setting item	Setting description
Search what	<ul style="list-style-type: none"> <li>Enter a search string.</li> <li>You can select from previous search strings in the list.</li> </ul>
Replace with	<ul style="list-style-type: none"> <li>Enter the string to replace the search string with.</li> <li>You can select from previous search strings in the list. You cannot use wildcard characters. (If you try to use them, they are treated as normal text strings.)</li> </ul>
Look in	<p>Specify the range to search. You can select from the following.</p> <p><b>Programming:</b> The entire <b>V+ Modules</b> of <i>RobotControlSettings</i> is searched.</p> <p><b>Checked elements:</b> The item that is selected in the <b>Select search and replace scope</b> dialog box is searched.</p> <p><b>Current view:</b> The current view is searched.</p>
Look at	<p>Specify the items to search. For the sub-device <i>RobotControlSetting</i>, only <b>All</b> can be searched.</p> <p><b>All:</b> Searches all text strings.</p>
Use	<p>Specify if you want to use wildcard characters.</p> <p><b>Default:</b> Do not use wildcard characters.</p> <p><b>Wildcard:</b> Use wildcard characters.</p>

## 10-6 V+ Version Configuration

This function sets the configured V+ versions of the Robot Integrated CPU Unit and OMRON robots to the same version. Even if the V+ versions of the Robot Integrated CPU Unit and robots do not match, you can use this function to set them to the same V+ version number in order to use the functions supported by that version.

You can check the current V+ versions and set the configured V+ versions in the **V+ Version Configuration** dialog box.



### Precautions for Correct Use

- Before you execute this function, use the synchronization function to match the program and configured data between the Sysmac Studio and the Robot Integrated CPU Unit.
- If this function changes a configured V+ version to a version number that is lower than the configured V+ version, you will not be able to use functions that are dependent on the V+ version.
- If you perform Clear All Memory operation on the Robot Integrated CPU Unit, the configured V+ versions set by this function will be cleared. After you perform Clear All Memory operation, reset or restart the Controller. If this function is used to set the configured V+ version, set the configured V+ versions again.

### 10-6-1 Checking V+ Versions

The following describes procedure for checking the V+ versions and configured V+ versions of the Robot Integrated CPU Unit and robots.

**Configure V+ version** will be enabled under the following conditions.

- The Sysmac Studio is not in Emulation mode.
- The project unit version of the Robot Integrated CPU Unit is 1.48 or later.
- The Sysmac Studio is online with the Controller.
- The Sysmac Studio's operation authority and the robot system operation authority verification meet one of the following. \*1

Sysmac Studio's operation authority	Robot system operation authority verification
Higher than Designer (Designer or Administrator)	Engineer
Higher than Designer (Designer or Administrator)	Not set
Not set	Engineer
Not set	Not set

\*1. Refer to 8-2 Robot System Operation Authority Verification on page 8-8.

- 1 In the Multiview Explorer, select **RobotControlSettings** from the device list. Then, click **Configure V+ version** in the **Controller** menu.

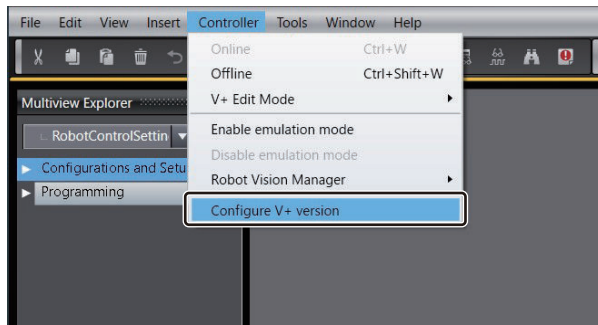

The **V+ Version Configuration** dialog box is displayed.

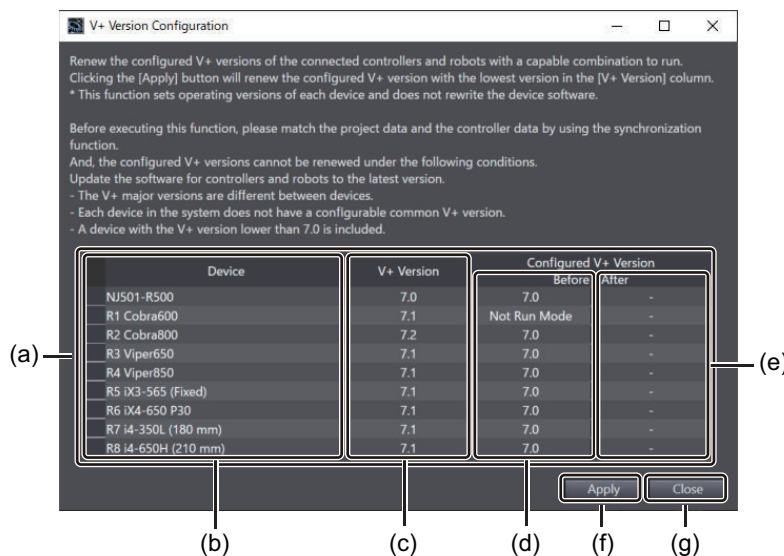

	Item	Description
(a)	List	The V+ versions of devices (Robot Integrated CPU Unit and robots) are listed.
(b)	Device	Each device is indicated in the following format. Robot Integrated CPU Unit: Model name Robot: "R" + "Robot number" + "Model name"*1
(c)	V+ Version	The V+ version of each <b>Device</b> is indicated in the following format. *2 Major version + "." + Minor version
(d)	Configured V+ Version Before	The current configured V+ version of each <b>Device</b> is listed. *3
(e)	Configured V+ Version After	The configured V+ versions of <b>Device</b> renewed by clicking the <b>Apply</b> button are listed.
(f)	<b>Apply</b> button	Click this button to set the configured V+ versions of the Robot Integrated CPU Unit and OMRON robots to the same version. *4
(g)	<b>Close</b> button	Click this button to close the <b>V+ Version Configuration</b> dialog box.

\*1. Robots that are not registered in the Sysmac Studio project will be indicated as "R" + "Robot number" + "Unknown Device".

\*2. Devices that do not support this function will be indicated as "Less than 7.0".  
Devices that cannot obtain the V+ version will be indicated as "Error".  
Robots that are not connected to the Controller will be indicated as "Not connected".

- \*3. The configured V+ version of any robot will be indicated as "Not Run Mode" if it is different from the configured V+ version of the Robot Integrated CPU Unit.
- \*4. This button will be disabled under the following conditions.
  - The renewal processing is already completed by clicking the **Apply** button.
  - The difference between the V+ versions of devices is out of the range.
    - a) The major version number is different.
    - b) There is no common configurable V+ version among the devices.
  - There is a device that does not support the configured V+ version number to be applied.
  - "Less than 7.0", "Error", or "Not connected" is indicated in **V+ Version**.
  - "Unknown Device" is indicated in **Device**.

## 10-6-2 Renewing V+ Versions

The following describes the procedure for renewing the configured V+ versions of the Robot Integrated CPU Unit and robots with the same version.

- 1 Click the **Apply** button in the **V+ Version Configuration** dialog box.

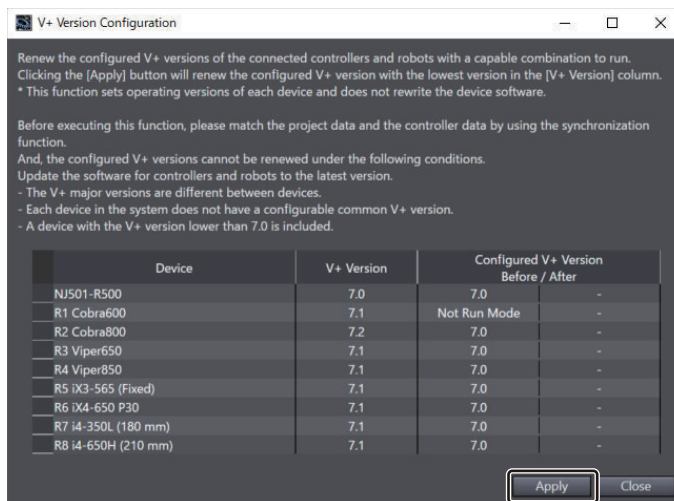

The following dialog box is displayed.

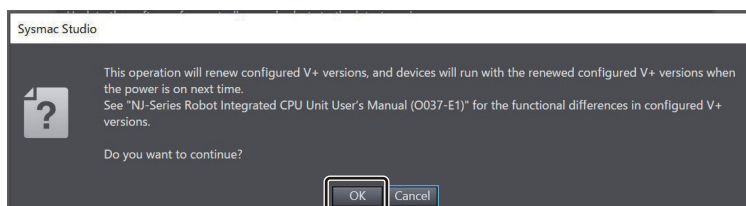

- 2 Click the **OK** button.  
The following dialog box is displayed.

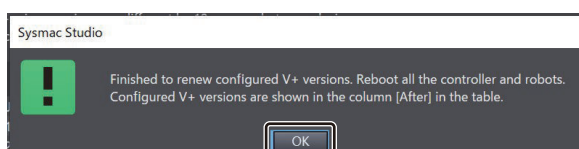

- 3 Click the **OK** button.

This applies the configured V+ versions and displays them in the **Configured V+ Version After** column in the **V+ Version Configuration** dialog box.

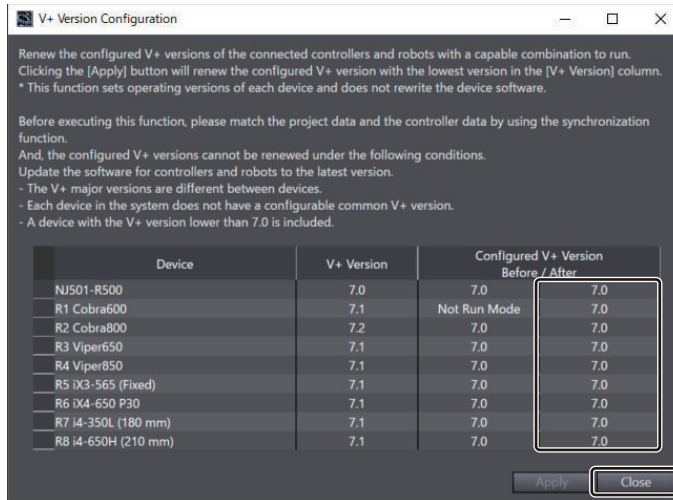

**4** Click the **Close** button.

**5** Cycle the power supplies to the Controller and robots.





# Appendices

The appendices provide the option settings, error messages lists, and other supplemental information for the body of this manual.

---

<b>A-1</b>	<b>Option Settings</b> .....	<b>A-2</b>
A-1-1	Display the Option Settings .....	A-2
A-1-2	Option Setting Items .....	A-2
<b>A-2</b>	<b>Version Control Function</b> .....	<b>A-4</b>
A-2-1	Precautions Common to All Devices .....	A-4
A-2-2	Robot Integrated CPU Unit.....	A-4
A-2-3	Application Manager .....	A-5

# A-1 Option Settings

Option settings are used to change the display and editor settings of the Sysmac Studio.

This appendix describes the option settings associated with the functions that you use to build a Robot Integrated System.

Refer to the *Sysmac Studio Version 1 Operation Manual (Cat. No. W504)* for option settings that are common to the Sysmac Studio.

## A-1-1 Display the Option Settings

- 1 Select **Option** from the **Tools** menu.  
The **Option** dialog box is displayed.

## A-1-2 Option Setting Items

Category	Setting item	Set value	Description
V+ Programs	Header for New V+ Programs	Enabled	You can specify header text for all new V+ Programs that you create. Unless you specify this text, new V+ Programs will contain only PROGRAM and END statements.
	Other Parameters	Allow automatic intelli-prompt pop-ups in the V+ editor	Set this value to display text candidates that match the entered characters when you enter a command in the V+ Program Editor.
		Editor Font	Selecting <b>Use Custom Font</b> allows you to specify the system font that is used in the V+ program editor. Click the <b>Select</b> button and, in the <b>Font Setting</b> dialog box, select a font and click the <b>OK</b> button. Then, the new font setting is used in the V+ program editor.
V+ Variables	V+ Variable Editor	<b>Value</b> column setting	Choose either of the following options to show in the <b>Value</b> column in V+ Variable Editor.
		Only <b>Value</b> column	The variable values in the Controller that is connected online are monitored and shown in <b>Value</b> . For variables that exist in only the project and do not exist in the Controller, the input values in the <b>Value</b> column will be set during transfer.
		<b>Initial Value</b> and <b>Online Value</b> column (default)	The variable values in the Controller that is connected online are monitored and shown in the <b>Online Value</b> column. For variables that exist in only the project and do not exist in the Controller, the input values in the <b>Initial Value</b> column will be set during transfer.

Category	Setting item	Set value	Description
3D Visualizer	Color Selection	Link Point	Change the display color of the items listed on the left in the 3D Visualizer.
		Mount Point	
		Snap Origin - Selected	
		Snap Origin - Unselected	
		Snap Point - Selected	
		Snap Point - Unselected	
		Snap Point - Line	
		Collision Hull	

## A-2 Version Control Function

This section describes the device-common and device-specific precautions and the displays for the safe use of project version control of Robot Integrated CPU Units and Application Managers. Refer to the *Sysmac Studio Project Version Control Function Operation Manual (Cat. No. W589)* for precautions and specifications of other devices.

### A-2-1 Precautions Common to All Devices

Precautions that are common to all devices are given below.

- You cannot import password-protected projects to the version control system. Disable the password protection before you import the project.
- If you develop a project with multiple developers, all involved should use the Sysmac Studio with the same language settings.
- You can merge changes in the following Multiview Explorer items to the data.
  - a) Controller's data in **Programming** and lower-level folders
  - b) HMI's data in Page and lower-level folders
  - c) Programs and variables of V+ modules of RobotControlSettings
  - d) The data of **User Functions** and **Shape Script** under **Configurations and Setup – 3D**

**Visualization** and the data of **Programming – Programs** in the Application Manager

However, you cannot merge changes in other than those items: the data will always be overwritten with the contents of either the source or target of the merge.

- User names and access levels and passwords and default user information of the robot system operation authority verifications are not version controlled. To use the Robot System Operation Authority Verification, set the user names, access levels, passwords and default user information.

### A-2-2 Robot Integrated CPU Unit

Observe the following precautions when you control the versions of projects that include the Robot Integrated CPU Unit.

#### Use

You cannot merge changes to the **Configurations and Setup** items of the sub-device of the Robot Integrated CPU Unit, **RobotControlSettings**. This data will always be overwritten with the contents of either the source or target of the merge.

If you develop Robot Integrated CPU Unit programs with multiple developers, allow one supervisor of the project development to edit the **Configurations and Setup** items.

If you edit the **Configurations and Setup** items with multiple developers, the changes in the **Configurations and Setup** items may not be merged as intended.

#### Sysmac Diff Dialog Box

This section describes displays specific to the RobotControlSettings.

### ● Project Comparison Window

The items of the RobotControlSettings on the project comparison window are as follows.

Item	Availability of Detailed Comparison	Details
Configurations and Setup		When you select <b>Configurations and Setup</b> of the Robot Integrated CPU Unit and click the <b>Select this to overwrite with left</b> button, the items under that <b>Configurations and Setup</b> will be candidates for overwriting.
Controller Settings		
Save Configuration		
Monitor Window		
Robots		
Programming		
V+ Modules		
Module name		The registered program items are displayed under <b>V+ Module</b> .
Program name	○	When you select an item and click the <b>Select this to overwrite with left</b> button, the item will be candidates for overwriting.
Variables	○	

Refer to the *Sysmac Studio Project Version Control Function Operation Manual (Cat. No. W589)* for usage of project comparison window.

### ● Detailed Comparison Window

The RobotControlSettings-specific comparison items on the **Detailed Comparison** window are as follows.

Item	Description	Detailed Comparison window
V+ Module Programs	Compares V+ module programs. You can overwrite the contents of the source of comparison with the target of comparison for each line.	Refer to the <i>Sysmac Studio Project Version Control Function Operation Manual (Cat. No. W589)</i> for usage of Detailed Comparison window.
V+ Module Variables	Compares V+ module variables. You can overwrite the contents of the source of comparison with the target of comparison for each variable.	

## A-2-3 Application Manager

Observe the following precautions when you control the versions of projects that include the application manager.

### Use

You can merge the following items of the Application Manager. The other data will be always overwritten with the contents of either the source or target of merge.

- **Configurations and Setup – 3D Visualization – Shape Script Functions – User Functions**
- **Shape Scripts** under **3D Visualization** in **Configurations and Setup**
- **C# program** under **Programs** in **Programming**

If you develop Controller programs with multiple developers, allow one supervisor of the project development to edit anything other than the items that can be merged. Otherwise, the changes may not be merged as intended.

## Sysmac Diff Dialog Box

This section describes displays specific to the Application Manager.

### ● Project Comparison Window

The items of the Application Manager device on the project comparison window are as follows.

Item	Availability of Detailed Comparison	Details
Configurations and Setup		
Settings		
3D Visualization		
Shape Script Functions		<ul style="list-style-type: none"> <li>The registered function items are displayed under <b>Shape Script Functions</b>.</li> <li>When you select an item and click the <b>Select this to overwrite with left</b> button, the item will be candidates for overwriting.</li> </ul>
User Functions name	○	
Default Functions name		
Box name		
Cylinder name		
CAD Data name		
Virtual Part Detection Sensor name		
Mechanical Component name		
Custom Mechanics name		
Parallel Link Model name		
Shape Script name	○	
Shape Script Sequence name		
Robot Vision Manager		
Robot Vision Manager setting items		
Cameras		The registered camera names are displayed under <b>Cameras</b> .
Camera name		
Configuration		The registered setting items that the Application Manager has are displayed under <b>Configuration</b> .
Application Manager setting items		
Feeders		The registered feeder names are displayed under <b>Feeders</b> .
Feeder name		

Item	Availability of Detailed Comparison	Details
Process		The registered process-related setting items are displayed under <b>Processes</b> .
Process-related setting items		
Vision Tools		The registered tool names for image processing used in the Robot Vision Manager are displayed under <b>Vision Tools</b> .
Image processing tool names in the Robot Vision Manager		
Programming		
Programs		The registered C# program names are displayed under <b>Programs</b> .
C# Program name	○	
Variables		When you select an item and click the <b>Select this to overwrite with left</b> button, the item will be candidates for overwriting.
Numeric Variable name		
String Variable name		

Refer to the *Sysmac Studio Project Version Control Function Operation Manual (Cat. No. W589)* for usage of project comparison window.

### ● Detailed Comparison Window

The Application Manager-specific comparison items on the **Detailed Comparison** window are as follows.

Item	Description	Detailed Comparison window
User Functions	Compares User Functions. You can overwrite the contents of the source of comparison with the target of comparison for each line.	Refer to the <i>Sysmac Studio Project Version Control Function Operation Manual (Cat. No. W589)</i> for usage of Detailed Comparison window.
Shape Scripts	Compares Shape Scripts. You can overwrite the contents of the source of comparison with the target of comparison for each line.	
C# Programs	Compares C# programs. You can overwrite the contents of the source of comparison with the target of comparison for each line.	







# Index



# Index

---

## S

---

Sysmac Studio Option License..... 1-6



**OMRON Corporation Industrial Automation Company**

**Kyoto, JAPAN**

**Contact : [www.ia.omron.com](http://www.ia.omron.com)**

**Regional Headquarters**

**OMRON EUROPE B.V.**

Wegalaan 67-69, 2132 JD Hoofddorp  
The Netherlands  
Tel: (31) 2356-81-300 Fax: (31) 2356-81-388

**OMRON ELECTRONICS LLC**

2895 Greenspoint Parkway, Suite 200  
Hoffman Estates, IL 60169 U.S.A.  
Tel: (1) 847-843-7900 Fax: (1) 847-843-7787

**OMRON ASIA PACIFIC PTE. LTD.**

438B Alexandra Road, #08-01/02 Alexandra  
Technopark, Singapore 119968  
Tel: (65) 6835-3011 Fax: (65) 6835-2711

**OMRON (CHINA) CO., LTD.**

Room 2211, Bank of China Tower,  
200 Yin Cheng Zhong Road,  
PuDong New Area, Shanghai, 200120, China  
Tel: (86) 21-5037-2222 Fax: (86) 21-5037-2200

**Authorized Distributor:**

©OMRON Corporation 2020-2023 All Rights Reserved.  
In the interest of product improvement,  
specifications are subject to change without notice.

**Cat. No. W595-E1-08 0423**