



Sensor Network Server

EQ100-E

User's Manual



Note

- (1) It is forbidden to duplicate, copy or reprint this manual in part or in whole without permission.
- (2) Please understand beforehand that the specifications in this manual may change without prior notice for the purpose of product improvement.
- (3) Best efforts have been applied to make sure that the details in this manual are correct; however, if there are any points which are incorrect or seem to be incorrect, please contact a branch office of Omron or one of its sales offices given at the end of this manual.

In doing so, please also state the catalog number given at the end of the manual.

Copyright and trademarks

- Windows is a trademark of **Microsoft Corporation USA**, registered in the USA and other countries.
- The SD, SDHC and SDXC logos are trademarks of SD-3C, LLC.
- Other system names and product names given in this manual are trademarks or registered trademarks of the respective companies.

Introduction

Thank you for purchasing the Sensor Network Server EQ100 (hereinafter called EQ100).

The EQ100 provides you with a method of visualizing energy amounts by collecting and accumulating measured data on a regular basis using devices such as power monitor, particle sensor, temperature controller and PLC.

Who this Manual is for

This manual is targeted at the following people.

- (1) Those with knowledge of electricity (electricians or those with equivalent knowledge),
and:
 - Those who have been responsible for installing FA devices
 - Those who have managed FA sites
- (2) Those who have LAN usage skills.

Request

This manual has information necessary for using the EQ100. Before using this software, please read this manual carefully and fully understand it. Also, even after reading this manual, please store it carefully in an easy-to-access place.

Terms and Conditions Agreement

Read and understand this catalog.

Please read and understand this catalog before purchasing the products. Please consult your OMRON representative if you have any questions or comments.

Warranties.

(a) Exclusive Warranty. Omron's exclusive warranty is that the Products will be free from defects in materials and workmanship for a period of twelve months from the date of sale by Omron (or such other period expressed in writing by Omron). Omron disclaims all other warranties, express or implied.

(b) Limitations. OMRON MAKES NO WARRANTY OR REPRESENTATION, EXPRESS OR IMPLIED, ABOUT NON-INFRINGEMENT, MERCHANTABILITY OR FITNESS FOR A PARTICULAR PURPOSE OF THE PRODUCTS. BUYER ACKNOWLEDGES THAT IT ALONE HAS DETERMINED THAT THE PRODUCTS WILL SUITABLY MEET THE REQUIREMENTS OF THEIR INTENDED USE.

Omron further disclaims all warranties and responsibility of any type for claims or expenses based on infringement by the Products or otherwise of any intellectual property right. (c) Buyer Remedy. Omron's sole obligation hereunder shall be, at Omron's election, to (i) replace (in the form originally shipped with Buyer responsible for labor charges for removal or replacement thereof) the non-complying Product, (ii) repair the non-complying Product, or (iii) repay or credit Buyer an amount equal to the purchase price of the non-complying Product; provided that in no event shall Omron be responsible for warranty, repair, indemnity or any other claims or expenses regarding the Products unless Omron's analysis confirms that the Products were properly handled, stored, installed and maintained and not subject to contamination, abuse, misuse or inappropriate modification. Return of any Products by Buyer must be approved in writing by Omron before shipment. Omron Companies shall not be liable for the suitability or unsuitability or the results from the use of Products in combination with any electrical or electronic components, circuits, system assemblies or any other materials or substances or environments. Any advice, recommendations or information given orally or in writing, are not to be construed as an amendment or addition to the above warranty.

See <http://www.omron.com/global/> or contact your Omron representative for published information.

Limitation on Liability; Etc.

OMRON COMPANIES SHALL NOT BE LIABLE FOR SPECIAL, INDIRECT, INCIDENTAL, OR CONSEQUENTIAL DAMAGES, LOSS OF PROFITS OR PRODUCTION OR COMMERCIAL LOSS IN ANY WAY CONNECTED WITH THE PRODUCTS, WHETHER SUCH CLAIM IS BASED IN CONTRACT, WARRANTY, NEGLIGENCE OR STRICT LIABILITY. Further, in no event shall liability of Omron Companies exceed the individual price of the Product on which liability is asserted.

Suitability of Use.

Omron Companies shall not be responsible for conformity with any standards, codes or regulations which apply to the combination of the Product in the Buyer's application or use of the Product. At Buyer's request, Omron will provide applicable third party certification documents identifying ratings and limitations of use which apply to the Product. This information by itself is not sufficient for a complete determination of the suitability of the Product in combination with the end product, machine, system, or other application or use. Buyer shall be solely responsible for determining appropriateness of the particular Product with respect to Buyer's application, product or system. Buyer shall take application responsibility in all cases.

NEVER USE THE PRODUCT FOR AN APPLICATION INVOLVING SERIOUS RISK TO LIFE OR PROPERTY WITHOUT ENSURING THAT THE SYSTEM AS A WHOLE HAS BEEN DESIGNED TO ADDRESS THE RISKS, AND THAT THE OMRON PRODUCT(S) IS PROPERLY RATED AND INSTALLED FOR THE INTENDED USE WITHIN THE OVERALL EQUIPMENT OR SYSTEM.

Programmable Products.

Omron Companies shall not be responsible for the user's programming of a programmable Product, or any consequence thereof.

Performance Data.

Data presented in Omron Company websites, catalogs and other materials is provided as a guide for the user in determining suitability and does not constitute a warranty. It may represent the result of Omron's test conditions, and the user must correlate it to actual application requirements. Actual performance is subject to the Omron's Warranty and Limitations of Liability.

Change in Specifications.

Product specifications and accessories may be changed at any time based on improvements and other reasons. It is our practice to change part numbers when published ratings or features are changed, or when significant construction changes are made. However, some specifications of the Product may be changed without any notice. When in doubt, special part numbers may be assigned to fix or establish key specifications for your application. Please consult with your Omron's representative at any time to confirm actual specifications of purchased Product.

Errors and Omissions.

Information presented by Omron Companies has been checked and is believed to be accurate; however, no responsibility is assumed for clerical, typographical or proofreading errors or omissions.

Meanings of Signal Words

To ensure the safe use of the EQ100, we use several safety icons to alert the reader to certain safety issues in this manual. The warning messages listed here indicate extremely important safety issues. Be sure to follow these guidelines. The icons and their meanings are as follows:

The following signal words are used in this manual.

 WARNING	Indicates a potentially hazardous situation which, if not avoided, will result in minor or moderate injury, or may result in serious injury or death. Additionally there may be significant property damage.
--	--

 CAUTION	Indicates a potentially hazardous situation which, if not avoided, may result in minor or moderate injury or in property damage.
--	--

Meanings of Alert Symbols



This triangle symbol indicates a caution (including a warning). Specific details are shown in the images in the triangles and in sentences.

The symbol on the left indicates “Warning: Explosive”.



This triangle symbol indicates a caution (including a warning). Specific details are shown in the images in the triangles and in sentences. The symbol on the left indicates “Caution: Electric Shock”.



This symbol indicates a prohibition. (including a warning). Specific details are shown in the images in the symbol and in sentences. The symbol on the left indicates “Prohibition on disassembling”.



This symbol indicates enforcement. Specific details are given in the image in the symbol and in sentences. The symbol on the left indicates “General items to comply”.

WARNING

A lithium battery is used for memory backup. Do not disassemble, apply pressure to deformation, overheat to more than 100°C, and/or burn it. Otherwise serious injury may occasionally occur due to fire and/or explosion.



Injury and damage to objects may occur due to electrocution, fire and faults. Do not place pieces of metal and wire debris into the product.



CAUTION

Electric shock may occur. Always make sure that the power is turned OFF before wiring the terminal unit or replacing the battery.



Breakdown or explosion may occur.
Use a power supply of the specified voltage.



Electrocution, fire, or a fault may occur.
Do not disassemble, repair or modify the product.



Precautions for Safe Use

Observe the following precautions to ensure safe operation.

- 1) Do not store and manage, install, or use the product in any of the following ways.
 - In a place with large vibrations or which is greatly influenced by shocks
 - Outdoors or in a place directly exposed to sunlight, or exposed to wind and rain
 - In a place at a temperature and humidity outside the specification range
 - In a place with great changes in temperature and humidity, or where there is a possibility of condensation
 - In a place affected by static electricity or noise
 - In a place with corrosive gas (particularly sulfide gas or ammonia gas)
 - In a place with a lot of dust or iron powder
 - In a place which is flooded or covered in oil
 - In a place with splashing salt water
- 2) Before using the device, you must check the wiring before connecting it to the power. Not doing so may result in electrocution, faults, accidents, injury, or incorrect operation due to incorrect wiring.
- 3) Use an appropriate electrical power source and wiring to connect the product to an electrical power source and in/output. Not doing so may result in electrocution, faults, accidents, injury, or incorrect operation due to incorrect wiring.
- 4) Do not use voltage greater than the standard one for generic input terminals.
- 5) Do not use voltage and do not connect a load greater than the standard for generic input terminals.
- 6) Carry out wiring by using a solderless terminal which appropriate fits the size of the terminal screw size.
- 7) Do not block the air ventilation holes of this product and the area surrounding them, in order to allow heat to be emitted.
- 8) Do not install this product near to machines which emit large amounts of heat (heaters, transformer, large capacity resistors, etc.)
- 9) In installation work, Type D earthing (Type 3 earthing) must be used.
- 10) Be sure to firmly secure the product with DIN rail or screw mounting before use.

Precautions for Correct Use

- 1) Be sure to mount screws and terminal screws to the main unit with the specified torque.
- 2) When connecting to a power source, make the power reach the rated voltage within 2 seconds. Not doing so may result in this product not functioning correctly.
- 3) The battery has a finite life. (Indicated life of 5 years: This may vary greatly depending on the usage conditions.) You must use batteries specific for this product.
- 4) The memory backup battery is a consumable item. When the battery's remaining capacity becomes low, the device alarm indicator (ERR) turns on and the battery must be replaced to new one.
- 5) Attach a new battery within five minutes from turning off the power. Otherwise the data cannot be retained.
- 6) If you do not use the product for a long period of time, remove the battery. This should prevent battery consumption and a failure due to leak.
- 7) Do not use thinner-type products when cleaning. Please use a commercially-available alcohol.
- 8) Dispose of this product in accordance with local and national disposal regulations.

Definition of Terms

Shown below are terms related to EQ100.

Term	Description
Measured Value	A measured value itself. One that is not handled as data by a collecting device or a computer yet.
Integrated Value	A measured value that is integrated, such as electric energy and gas flow rate.
Instantaneous Value	A measured value that is not integrated, as such as temperature and humidity.
Measured Data	Data that is collected and saved by a measurement device or software (EQ-ServerService).
Energy Data	Data that can be converted into energy value, such as electric energy. It applies to some measured data that can be integrated.
Data Type	A category of data that defines a unit of data, summary method, or discrimination of integral and instantaneous values.
Summary	To summarize data based on a time unit defined as a summary interval. For an integrated value, the sum is used. For an instantaneous value, either of an average, maximum, or minimum value is used as a representative value.
Summary Data	Data summarized by a summary process.
Summary Interval	A unit of time to view a graph of the summarized data.
Energy consumption	Energy consumption is the amount of energy of production necessary to produce fixed quantities.
Channel	An item of data to collect from a measurement device or a collecting device. EQ100 has following two channels: - Measurement Channel - Operation Channel
Measurement Channel	A channel that is measured and collected by a measurement device. Included are electric energy, pulse, temperature, and foreign object amount.
Operation Channel	A channel created through operation of the measurement channel inside EQ100. There are two types of channels based on a difference of operation; a free operation channel and a basic unit operation channel.
Channel Group	A grouping to manage channels together in a production line, on a floor, and/or a building.
Device	Either of a measurement device or a collecting device that has a channel. A connection device is not included.
Measurement Device	Measurement devices include a sensor that measures a physical value such as electric energy, temperature, and humidity, and that and sends the measured value, as well as a device that keeps measured data from a sensor connected to the device and that provides the data for EQ100 (e.g. PLC and ZN-KMX21), having a measurement channel.
Connection Device	A device that does not have a measurement channel and that relays and provides measured data from a measurement device connected to the connection device for the EQ100 (e.g. WZ-MLAN01).

Term	Description
Collecting Device	A device that collects, stores, and sends data from a measurement device to the upper level system. It applies to EQ100.
Control Value	A threshold value to manage a range of values for each channel, defined as an upper and/or lower limit. When a value is out of the control value, the monitoring alarm detects and reports it.
Monitoring Alarm	A function that detects and reports a value exceeding a control value.
Monitoring Alarm Email	An email automatically sent upon a monitoring alarm event.
Device Alarm	A function that reports an instrument failure, setup/status, device, communications, and/or monitoring process of EQ100.
Device Alarm Email	An email automatically sent upon a device alarm event.
Logging	To store data with the time of saving for each measurement interval.
Log Data	Collected data.
Event Log	A generic name for monitoring alarm, device alarm, and internal event.
Event Log File	A file that saves an event log.
Summary DB	A DB (database) that stores collected and summarized data and that is managed by the EQ server.
Collecting Interval	An interval for EQ100 to collect data from a measurement device.
Collected Data	Data that is collected and saved by a collecting device or software (EQ-ServerService) in a certain interval.
Collected Data File	A file in a CSV format containing collected data output.
Communication Test	A status to check communications by continuous execution of data collecting from a measurement/collecting device. This does not perform logging of collected data.
Periodic Report	A function to send an email with content configured by a user beforehand on a specified time for alive monitoring.
General-Purpose Input	A contact input to assign a function. In case of EQ100, it is assigned to the pulse input function.
General-Purpose Output	A contact output to assign a function. In case of EQ100, it is used for the monitoring alarm contact output.
Differential Processing	A process that stores a measured value collected from a measurement device and calculates a difference with the previous measured value. It is a process for integrated values such as electric energy and integrated flow rate.
CompoWay/F	OMRON's dedicated serial communications protocol supported by OMRON's component devices.
Web UI Function	A function to view data incorporated into EQ100. It allows a user to view EQ100 status and collected data graph and perform maintenance through a Web browser on a computer.
EQ-Viewer	Software to configure EQ100 settings and view collected data graph. It consists of EQ-Manager, EQ-ServerService, and EQ-GraphViewer.
EQ-Manager	Software to configure EQ100 and EQ server settings and perform operation management.
EQ-GraphViewer	Software to view and analyze a graph of collected data.

Term	Description
EQ-ServerService	Software to collect and provide data in the background as a Windows service.
Project	A file created by EQ-Manager to store configuration information required for operation of EQ100 and EQ server.
EQ Project	A project that describes operation settings of EQ100. It is created using EQ-Manager.
EQ Server Project	A project that describes operation settings of EQ server. It is created using EQ-Manager. It must be created if EQ-GraphViewer is used.
EQ Server	A computer that collects data from EQ100 using EQ-ServerService. It acts as a server under a server-client configuration.
EQ-Watcher	Paid software to view realtime measured data such as energy usage.

Manual Revision History

A manual revision symbol is added to the end of the catalog number on the front and back covers.

Catalog No. N196-E1-01

↑
Revision code

Revision code	Date	Revised contents
01	December 2017	First edition
02	September 2019	Changes <ul style="list-style-type: none"> - Added support for the following function codes of Modbus RTU. Coil read (01), input status read (02), input register read (04) - Modified operation so that data collection should not stop when a PLC operation continuation failure occurred. - Fixed the bug that some symbols are unavailable for email password. - Improved alarm output operation. - Supported 1 minute of CSV output.
03	October 2021	Changes <ul style="list-style-type: none"> - The number of operation channel inputs has been expanded to 32 channels.

Related Manual

Catalog No.	Manual Title	Details
N198-E1-01	EQ-Viewer User's Manual	Describes functions and usage of the graph display tool EQ-Viewer.

Table of Contents

Introduction	1
Meanings of Signal Words	3
Meanings of Alert Symbols	3
Precautions for Safe Use.....	5
Precautions for Correct Use.....	6
Definition of Terms.....	7
Manual Revision History	10
Related Manual	11
Table of Contents.....	12
1. Overview of EQ100.....	1-1
1.1. Overview	1-1
1.2. Features	1-1
1.3. Overview of Graph Display Tool.....	1-2
1.4. Functional Overview of EQ100	1-5
1.4.1. Energy Data Collecting Function	1-6
1.4.2. External Interface Function	1-9
1.4.3. Maintenance Function	1-10
1.5. System Configuration Example	1-11
1.5.1. Standalone Configuration.....	1-11
1.5.2. Network Configuration	1-12
1.5.3. Configuration with FTP	1-13
1.6. EQ100 Input/Output and Internal Configuration.....	1-14
2. Specifications.....	2-1
2.1. Part Name.....	2-1
2.1.1. EQ100 Front End.....	2-1
2.1.2. EQ100 Top View.....	2-3
2.1.3. Button.....	2-4
2.1.4. Indicator	2-5
2.1.5. Connector/Terminal Name.....	2-7
2.1.6. DIP Switch	2-10
2.1.7. SD Card Slot	2-11
2.1.8. Memory Backup Battery.....	2-12
2.2. Ratings and Performance	2-14
2.2.1. Hardware Specifications	2-14
2.2.2. Software Specifications	2-17
2.3. Supported Devices.....	2-22
2.4. Network.....	2-25
2.5. Dimensions	2-26

3.	Operation Mode and Status	3-1
3.1.	Operation Mode	3-1
3.2.	Setup Status and Collecting Status	3-2
3.3.	Specifications of Operation Mode and Status	3-4
4.	Basic Operation Steps	4-1
4.1.	[STEP 1] Standalone Configuration	4-1
4.2.	[STEP 2] Network Configuration with EQ Server	4-5
4.3.	[Reference] Taking Out Collected Data Using SD Card	4-7
5.	Installation and Wiring	5-1
5.1.	Precautions on Installation	5-1
5.2.	Battery Connection	5-2
5.3.	Mounting Inside the Cabinet	5-4
5.4.	Screw-Mounting	5-5
5.5.	Wiring Description	5-6
5.5.1.	Power and Grounding Wires	5-6
5.5.2.	RS-485 Communication Port	5-7
5.5.3.	General-Purpose Output Terminal	5-9
5.5.4.	LAN Connection Port	5-10
5.5.5.	SD Card	5-11
6.	Measurement Device Setup and Connection	6-1
6.1.	Measurement Device Main Body Setup and Measurement Setup	6-1
6.1.1.	Preparation	6-1
6.1.2.	Measurement Device Setup	6-3
6.2.	Connection between EQ100 and Measurement Device	6-7
6.2.1.	Wiring for LAN-Connected Measurement Device	6-9
6.2.2.	Wiring of RS-485-Connected Measurement Device	6-11
6.2.3.	Connection to Pulse Output Measurement Device	6-12
7.	EQ100 Settings	7-1
7.1.	Overview of EQ100 Settings	7-1
7.2.	Creating New EQ Project	7-2
7.3.	Editing EQ100 IP Address/Device Name	7-4
7.4.	Collecting Setting	7-5
7.4.1.	Overview	7-5
7.4.2.	Connection Device Registration	7-7
7.4.3.	Measurement Device Registration	7-10
7.4.4.	Channel Registration	7-23
7.4.5.	Operation Channel Setting	7-31
7.4.6.	Creating/Editing Data Type	7-37
7.4.7.	Group Registration	7-40
7.5.	EQ100 Monitoring Setting	7-45

7.5.1	Overview.....	7-45
7.5.2	Monitoring Alarm	7-45
7.5.3	Device Alarm.....	7-46
7.5.4	Periodic Report	7-46
7.5.5	Control Value Setting.....	7-47
7.5.6	Notification Setting	7-48
7.5.7	Periodic Report Setting.....	7-50
7.5.8	Destination Setting	7-51
7.5.9	Output Terminal Setting.....	7-54
7.5.10	Email Transmission Setting	7-56
7.5.11	Checking Email Transmission.....	7-57
7.6	EQ100 Settings.....	7-58
7.6.1	Overview.....	7-58
7.6.2	Language/Time Zone Setting.....	7-58
7.6.3	EQ100 Time Synchronization.....	7-59
7.6.4	Configuring EQ100 LAN Connection Port/Sub-LAN Connection Port	7-60
7.6.5	Configuring RS-485 Communications Port	7-62
7.6.6	Changing Password for Access from Web UI Function.....	7-64
7.7	Output Setting of Collected Data/Event Log File.....	7-66
7.7.1	Overview.....	7-66
7.7.2	User-Specified File	7-66
7.7.3	SD Card Output Setting.....	7-68
7.7.4	FTP Server Setting.....	7-69
7.7.5	FTP Transfer of Collected Data	7-71
7.8	Saving EQ Project	7-74
7.9	Writing EQ Project File to EQ100.....	7-75
7.9.1	Overview.....	7-75
7.9.2	Writing EQ Project File through SD Card.....	7-76
7.9.3	Writing EQ Project by EQ-Manager.....	7-78
7.9.4	Writing EQ Project by Web UI Function.....	7-81
8.	Communication Test and Collecting Start	8-1
8.1.	Preparation for Communication Test	8-1
8.2.	Communication Test Operation by EQ-Manager	8-2
8.2.1.	Starting Communication Test.....	8-2
8.2.2.	Ending Communication Test	8-4
8.3.	Communication Test Operation by Web UI screen.....	8-5
8.4.	Start Collecting	8-6
8.4.1.	Starting Collecting by EQ100 Operation	8-6
8.4.2.	Starting Collecting by EQ-Manager Operation.....	8-7
8.4.3.	Starting Collecting by Web UI Screen Operation	8-7

8.5.	Checking Collected Data.....	8-8
8.5.1.	Data in EQ100 after Collecting	8-8
8.5.2.	Internal Folder Structure of EQ100.....	8-9
9.	Web UI Function	9-1
9.1.	Overview of Web UI Function	9-1
9.1.1.	Operating Environment	9-2
9.2.	Connecting from Web Browser	9-4
9.3.	Top Screen.....	9-7
9.4.	Monitoring Screen	9-8
9.5.	Simple Graph View > Current Value Monitor	9-10
9.6.	Simple Graph View > Graph View	9-13
9.7.	Simple Graph View > Basic Unit View	9-15
9.8.	Maintenance > Setting View	9-17
9.9.	Maintenance > System.....	9-20
9.10.	Maintenance > Operation Check	9-22
9.11.	Maintenance > Data Acquisition.....	9-23
9.12.	Maintenance > File Download.....	9-24
9.13.	Maintenance > Update.....	9-26
9.14.	Help Screen.....	9-27
10.	Viewing/Analyzing Graph on EQ-GraphViewer.....	10-1
10.1.	Basic Operation Steps.....	10-1
10.2.	Connecting to EQ Server	10-2
10.3.	Selecting a Channel Group to Display.....	10-3
10.4.	Configuring Graph View	10-5
10.5.	Other Operations.....	10-11
10.5.1.	Displaying Past Data Comparison Screen.....	10-11
10.5.2.	Displayed Graph Output.....	10-11
10.5.3.	Displayed Data Output	10-11
10.5.4.	Exporting CSV File.....	10-11
11.	Safe Mode	11-1
11.1.	Startup in Safe Mode	11-1
11.2.	Safe Mode Web UI Screen.....	11-3
11.3.	Setting/Stored Information Clear	11-5
11.4.	Updating the Firmware	11-6
11.5.	Log Clear.....	11-8
11.6.	Recovering to Factory Shipment Status.....	11-9
11.7.	Exiting Safe Mode	11-10
12.	Appendix	12-1
12.1.	Troubleshooting	12-1
12.1.1.	Overview of Error Status Types and Actions.....	12-5

12.1.2.	Event Log Code List	12-6
12.2.	Subjective Operation Guide.....	12-12
12.2.1.	Setting for EQ100	12-12
12.2.2.	Taking Out EQ100 Collected Data	12-14
12.2.3.	EQ100 Operation	12-14
12.2.4.	Taking Out EQ100 Collected Data	12-15
12.3.	FAQ (Frequently Asked Questions)	12-17
12.4.	Adding/Deleting Measurement Device	12-19
12.4.1.	Failure and Replacement of Measurement Device	12-20
12.4.2.	Support for New Measurement Device	12-20
12.5.	Impact of Time Synchronization on Collected Data	12-21
12.6.	Web UI Screen on Internet Explorer 8 (IE8).....	12-22
12.7.	Communications Protocol.....	12-23
12.8.	SD Card Folder Configuration	12-24
12.9.	Output File Format.....	12-25
12.9.1.	Internal System File (e.g. SD Card Output, FTP Download)	12-25
12.9.2.	User-specified file (data acquisition with Web UI, user-specified file)	12-27
12.9.3.	Event Log File.....	12-29
12.10.	Software License	12-30

1. Overview of EQ100

1.1. Overview

EQ100 is energy data collecting equipment that periodically collects measured data from measurement devices connected to RS-485 communications port and LAN port and stores the data in its internal memory.

EQ100 can connect a variety of measurement devices to collect a large amount of measured data. It can also register an operation channel the operated the measured data and monitor measured data for alarm output. The incorporated Web UI function allows a user to operate EQ100 and view a simple graph on a Web browser. Attached graph display tool EQ-Viewer allows advanced graph display and data analysis.

1.2. Features

EQ100 has following features:

Features	Details
A variety of measurement devices can be connected	EQ100 can connect various devices such as RS-485-connected KM series, power monitor/temperature controller/analog value input digital panel meter, as well as LAN-connected particle/air flow device/PLC, in addition to wireless devices such as thermo-humidity/illuminance/CO2 sensor.
A large amount of measured data can be collected	Up to 500 channels can be registered to EQ100. Configurable intervals to collect data from measurement devices are 1 minute/5 minutes/10 minutes/30 minutes/60 minutes (the number of channels that can be registered is limited based on the measurement devices and data collecting interval).
Measurement channel can be operated	An operation channel can be created as a new channel through operation of measurement channels. There are two types of operation channels; a free operation channel that can specify any operation expression and a basic unit operation channel calculated based on basic units of two measured data.
Monitoring Alarm Function	For each collected measured data, configuration is available on monitoring conditions based on control value and count, email notification output upon the conditions, and monitoring alarm output to general-purpose output terminal.
Sub-LAN connection port available	In addition to the standard LAN port, a sub-LAN port is available for network configuration dedicated to LAN-connected measurement device. Connecting a LAN-connected measurement device to the sub-LAN port enables stable measured data collecting through the dedicated network.
Communication test function with measurement devices	The communication test function allows checking availability of communications between EQ100 and a measurement device as well as stable communications with a measurement device beforehand. In addition, it can be used to investigate a cause of a communication failure/error during data collecting.
Simple operation through Web UI function	The Web UI function of EQ100 allows a user to operate EQ100, view a simple graph of measured data, and check an operation status on a Web browser.
Advanced view/analysis by graph display tool	Attached graph display tool EQ-Viewer allows automatic summary of collected data of EQ100 to the EQ server and detailed graph display and analysis by the analysis tool EQ-GraphViewer.

1.3. Overview of Graph Display Tool

EQ-Viewer, included in the attached CD-ROM, is an integrated software package to materialize configuration for EQ100 to collect measurement device data, graph display and analysis of the collected data, and information sharing in an organization.

It contributes to materialization of "visualization at the site level" of energy and other environmental data.

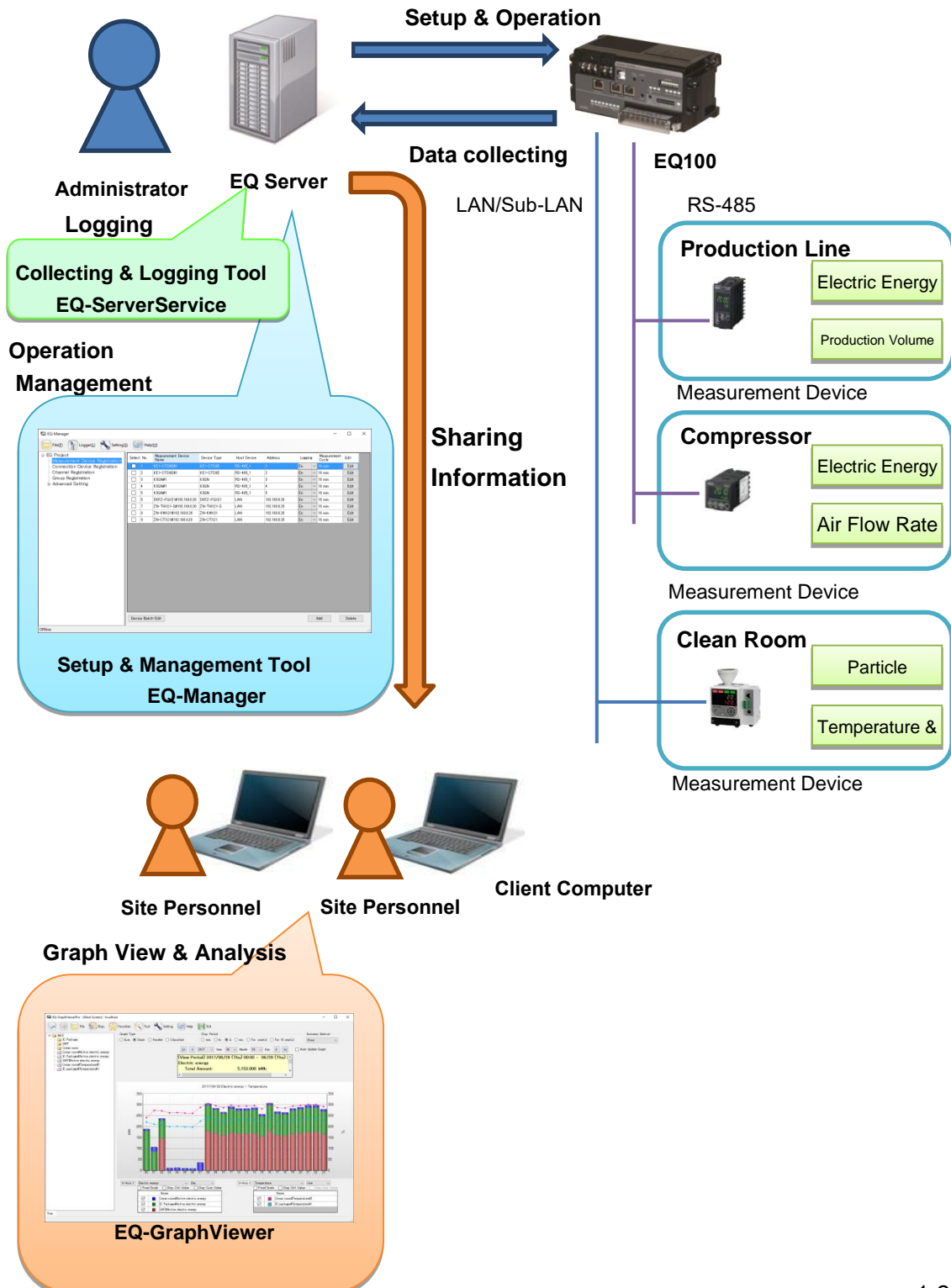

EQ-Viewer contains the following software components:

Name	Description
EQ-Manager	EQ-Manager is software to configure settings and manage operation of EQ100 itself as well as the EQ server. Major functions include: - Setup: EQ100 setting, measured data collecting setting, monitoring setting - Operation/display: EQ100 operation, status display
EQ-GraphViewer	EQ-GraphViewer is software to make access to the EQ server and to view and analyze log data collected and summarized by the EQ server from EQ100. Major functions include: - Graph display: Bar graph, line graph, summary view, comparison view - Summarized data file output
EQ-ServerService	This software performs data collecting, logging, and monitoring in a computer, running as a Windows service in the background. It connects to EQ100 to collect and log collected data in EQ100 in the specified cycle and saves the data as summarized data DB. EQ-GraphViewer and EQ-Manager connect to EQ-ServerService to perform various operations. Major functions include: - Automatic collecting of summarized data in EQ100 - Creation and management of summarized data DB, and publication to EQ-GraphViewer

Precautions for Correct Use

- The software described above cannot perform initial setting of measurement devices connected to EQ100. Before configuring EQ100, use the measurement device itself or the device's setup tool to configure initial setting.

■EQ-ServerService/EQ Server

When EQ-Viewer is installed, EQ-ServerService is automatically installed as well. EQ-ServerService is an application running as a Windows service in the background. A computer that runs EQ-ServerService is called EQ server.

Major functions of EQ-ServerService include:

Function	Description
Acquisition of Setting Value	Acquires project data from EQ-Manager.
Collecting Function	Acquires collected data from EQ100 through the network in a specified period.
Logging/Summary Database Management	Summarizes the acquired collected data and saves in the summary data DB on the EQ server. The data is published to EQ-GraphViewer.

■Project to be Created by EQ-Manager

To run EQ100 and EQ server, a project must be created by EQ-Manager and written to EQ100 and EQ server respectively.

There are following two types of projects:

Project Name	Description
EQ Project	<p>A project that describes operation settings of EQ100.</p> <p>An EQ project performs measured data collecting setting from a measurement device to EQ100 and EQ100 monitoring setting (the measurement device and its channel are registered in the collecting setting).</p> <p>If there are more than one EQ100, a project must be created for each EQ100.</p>
EQ Server Project	<p>A project that describes operation settings of EQ server. An EQ server project performs setting of collecting from EQ100 to EQ server and monitoring setting on EQ server. In the collecting setting, EQ100 must be registered. A channel must be loaded by the corresponding EQ project or actual EQ100.</p> <p>If there are more than one EQ100, settings of multiple EQ100s are done in one EQ server project.</p>

Reference

- For details of EQ-Viewer, see "EQ-Viewer User's Manual"(catalog No. : N198-E1-01).

1.4. Functional Overview of EQ100

EQ100 provides various functions including energy data collecting that collects and stores measured data from measurement devices, communications with an upper level system, external interface such as Web UI, maintenance function such as saving and loading of settings and updating of the firmware.

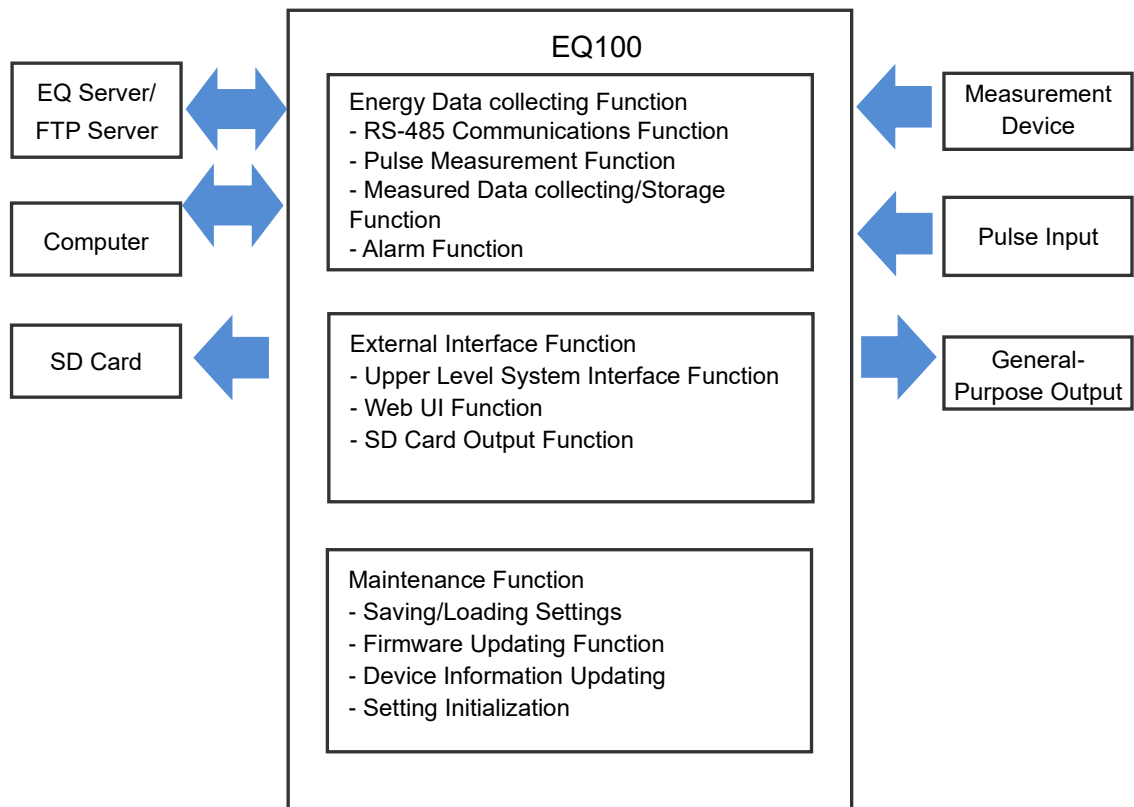

1.4.1. Energy Data Collecting Function

The energy data collecting function of EQ100 stores measured data from measurement devices connected to a network connection port and/or RS-485 communications ports as well as measured pulse data from the general-purpose input terminal of the EQ100 into the internal memory.

The function includes monitoring that operates general-purpose output terminals and/or sends email notification when collected measured data meets the configured monitoring condition.

1.4.1.1. LAN Communications Function

This function allows collecting of measured data from measurement devices connected to a LAN port, PLC, and/or wireless devices.

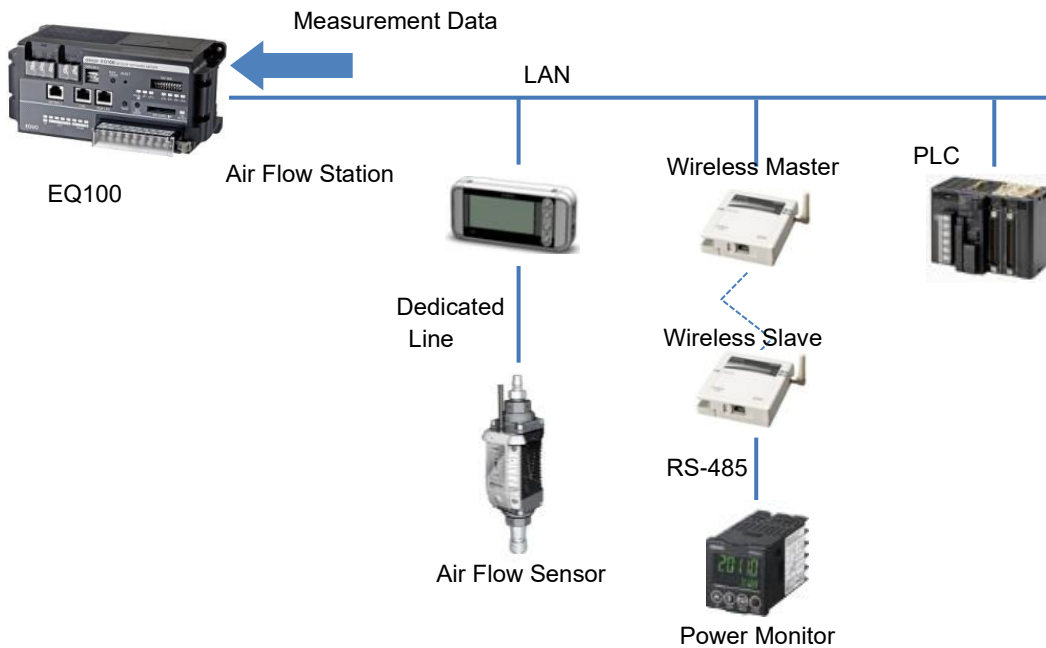

1.4.1.2. RS-485 Communications Function

This function allows collecting of measured data from measurement devices that support CompoWay/F communications protocol.

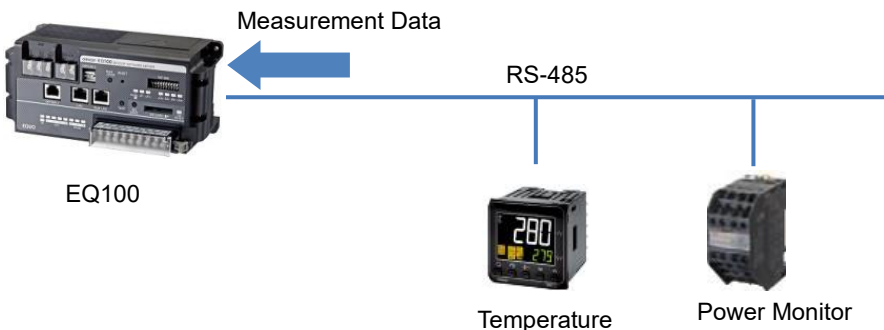

Reference

- EQ100 has four RS-485 communications ports. Up to 31 measurement devices can be connected to one port (31 x 4 ports= Total 124 devices).

1.4.1.3. Pulse Measurement Function

This function allows measurement of pulse count from a pulse-output measurement device connected to the general-purpose input terminal of EQ100.

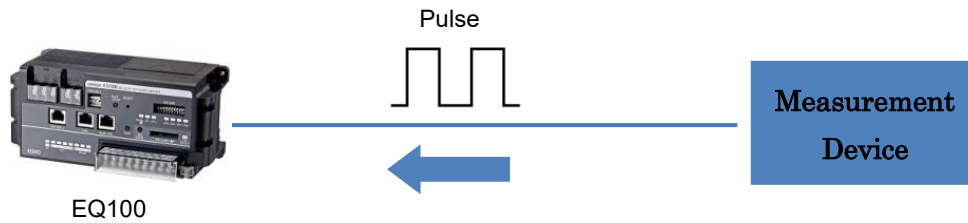

Reference

- EQ100 has a conversion function from pulse count to actual measured value, which allows converted measured value to save instead of the pulse count.

1.4.1.4. Measured Data Collecting/Storage Function

This function allows collecting and temporary storage of measured data from devices into internal memory.

The internal memory is nonvolatile and can keep data upon blackout. Old measured data are sequentially overwritten when the internal memory is full.



Precautions for Correct Use

- The retention period of data convergence in the EQ100's internal memory is one week (collected data older than one week are overwritten by newly collected data from the oldest one).
- To keep collected data older than one week in EQ100, use an SD card to save.
- Data output will get unavailable when the SD card has no free space. In such a case, you occasionally need to move the output files on the SD card to other places such as a computer or use a new SD card.

1.4.1.5. Monitoring Function

The monitoring function operates external output terminals and/or sends email notification when collected measured data meets the configured condition.

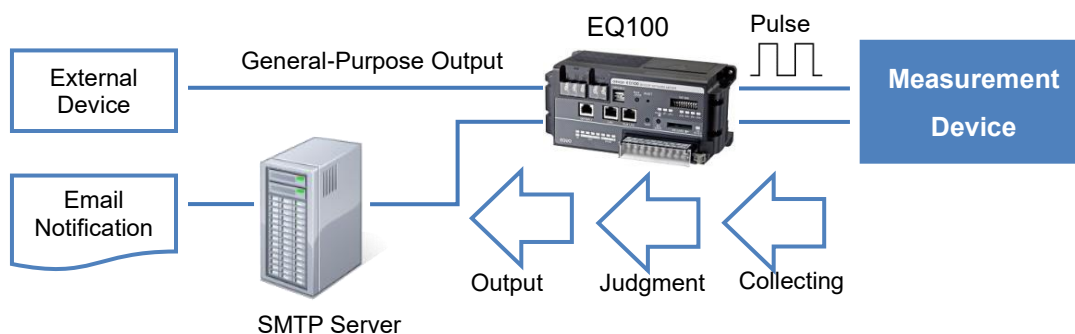

An alarm is judged by specified measured data getting over or under the configured control values. Up to 500 judgment conditions can be configured.

The monitoring alarm output function turns on and off the general-purpose output terminal contacts based on the alarm judgment result. There are four monitoring alarm outputs, for each of which independent conditions can be configured.

The notification function reports an occurrence of a monitoring alarm using an Email.

1.4.2. External Interface Function

The external interface function includes the upper level system interface for communications with an upper level system such as the EQ server, Web UI function for simple graph view and maintenance, and measured data output to an SD card.

1.4.2.1. Upper Level System Interface Function

This function allows connection with an upper level system via LAN. The following functions are available by collaborating with the attached software.

■ EQ-Manager

EQ-Manager is software to configure settings and manage operation of EQ100 and EQ server.

■ EQ-GraphViewer

EQ-GraphViewer is software to view and analyze data collected from measurement devices.

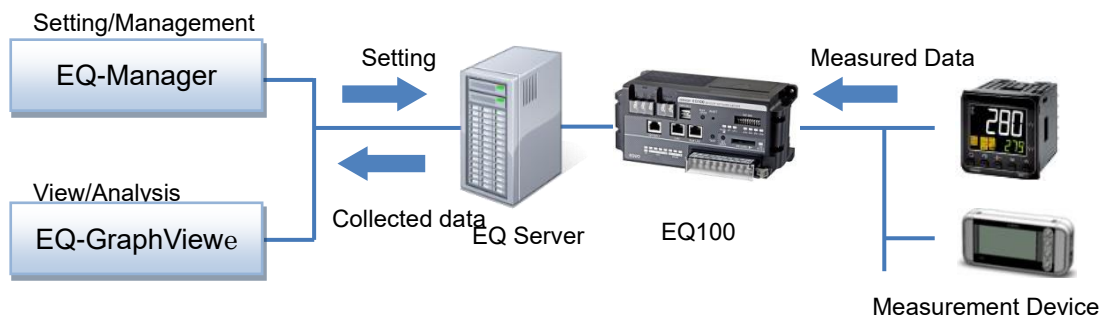

1.4.2.2. Web UI Function

This function allows a user to view EQ100 status and simple graph of collected data and perform maintenance through a Web browser on a computer.

■ Web UI Screen Top Page

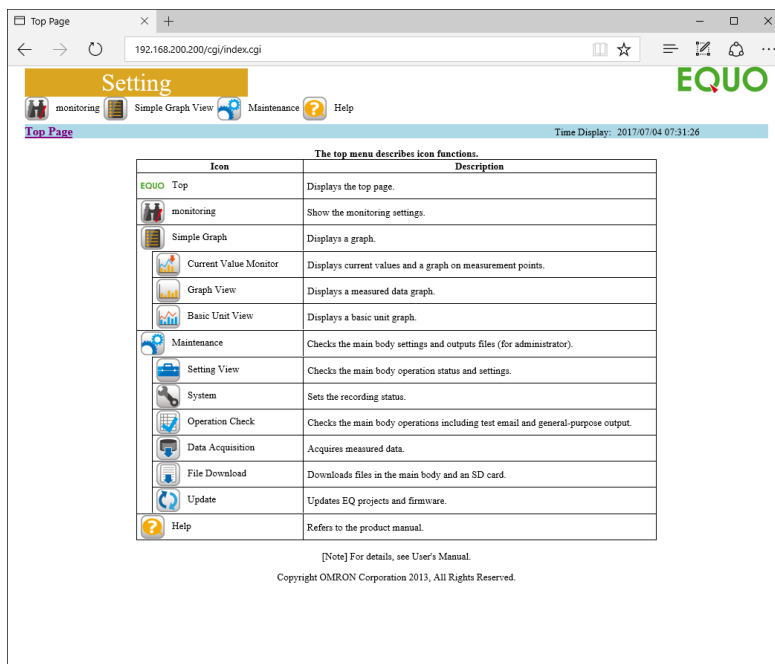

1.4.2.3. SD Card Output Function

This function outputs collected data to an SD card. The collected data is outputted to an SD card once a day.

In addition, operating on the Web UI screen or pressing the SD card save button outputs stored data at the time of the operation without waiting for periodical output.

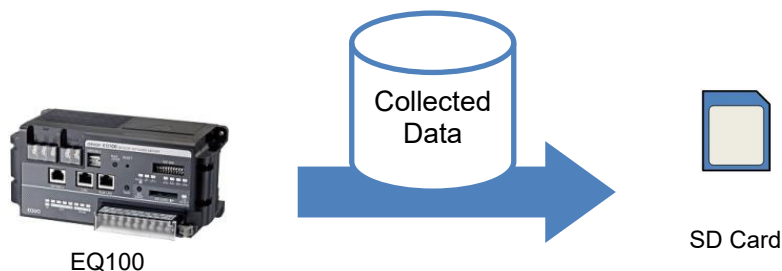

Reference

- The SD card output may take a long time from the operation to output to finish, depending on the amount of data to save. Before ejecting the SD card, check the Web UI screen message and/or buzzer sound for the completion of output.
- Upon the 1st SD card output after the setup, all data stored before then are outputted. If the amounts of data that are not saved for a long time exist, output will take a long time to finish.

1.4.3. Maintenance Function

■ Saving/Loading Settings

An EQ project created by EQ-Manager can be saved as a file in a computer. Loading the saved EQ project to EQ100 can restore the settings.

■ Firmware Update Function

The EQ100 firmware can be updated by starting under the safe mode and using the Web UI function. To reflect the change, the system must be restarted.

■ Setup Initialization

This function initializes all the settings back to the ones for factory shipment.

1.5. System Configuration Example

Shown below are typical system configurations of EQ100.

1.5.1. Standalone Configuration

EQ100 is operated without connecting to an upper level system, and collected data are taken out when necessary. A user can view EQ100 status and collected data graph and perform maintenance through a Web browser on a computer directly connected to EQ100.

Collected data are saved in the EQ100 internal memory or an SD card in a CSV file.

Collected data are taken out by:

- Connecting EQ100 and a computer via a LAN cable, making access to EQ100 via a Web browser, and downloading the data when necessary.
- Outputting measured data from the internal memory to an SD/SDHC card when necessary (measured data output from the internal memory to SD/SDHC card is done in a specified period or by pressing the SD card save button on the front end).

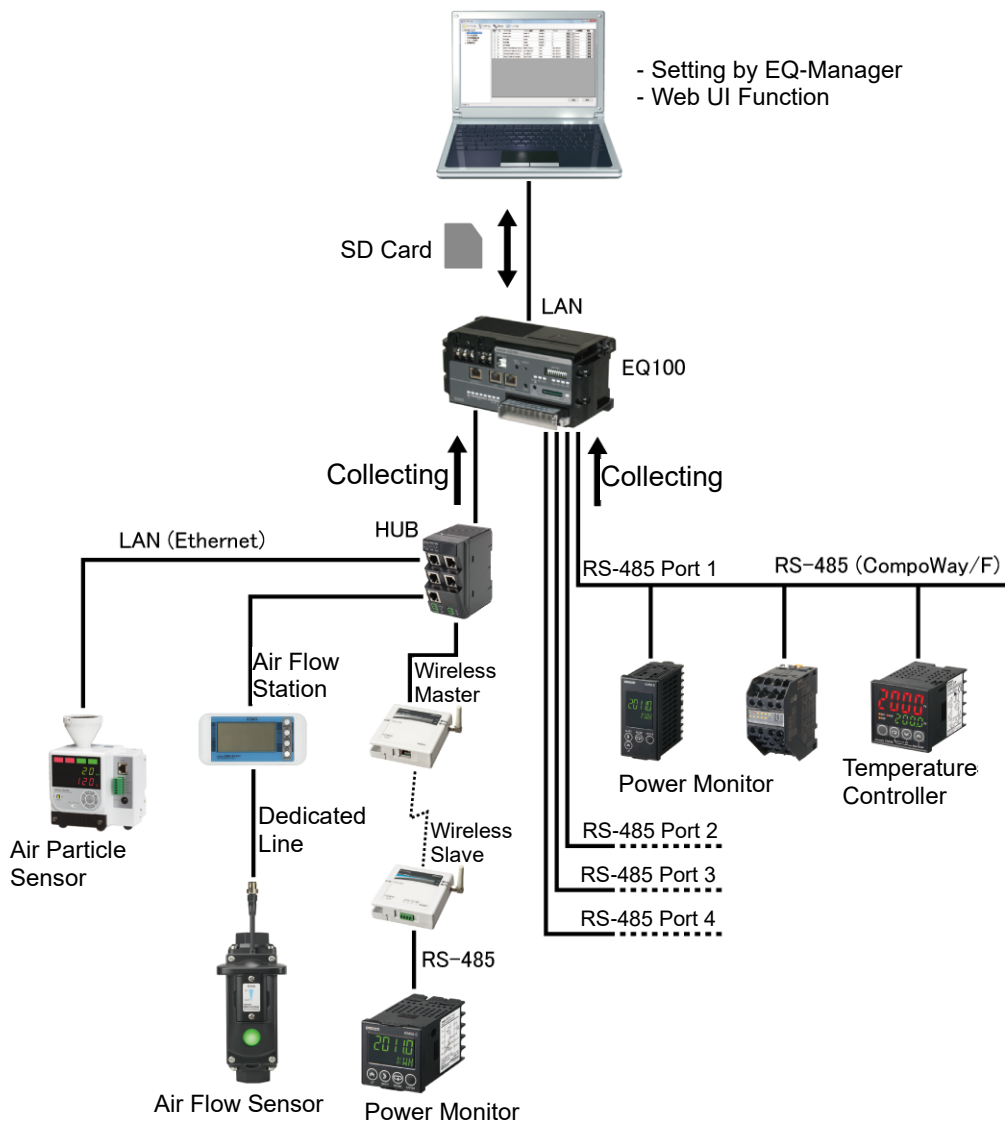

1.5.2. Network Configuration

One EQ server can manage multiple EQ100s that are connected via LAN.

The EQ server performs logging of collected data file stored in EQ100s in a specified period and saves into the summary DB.

EQ-GraphViewer allows graph view and analysis of summary data in the EQ server to share information in an organization.

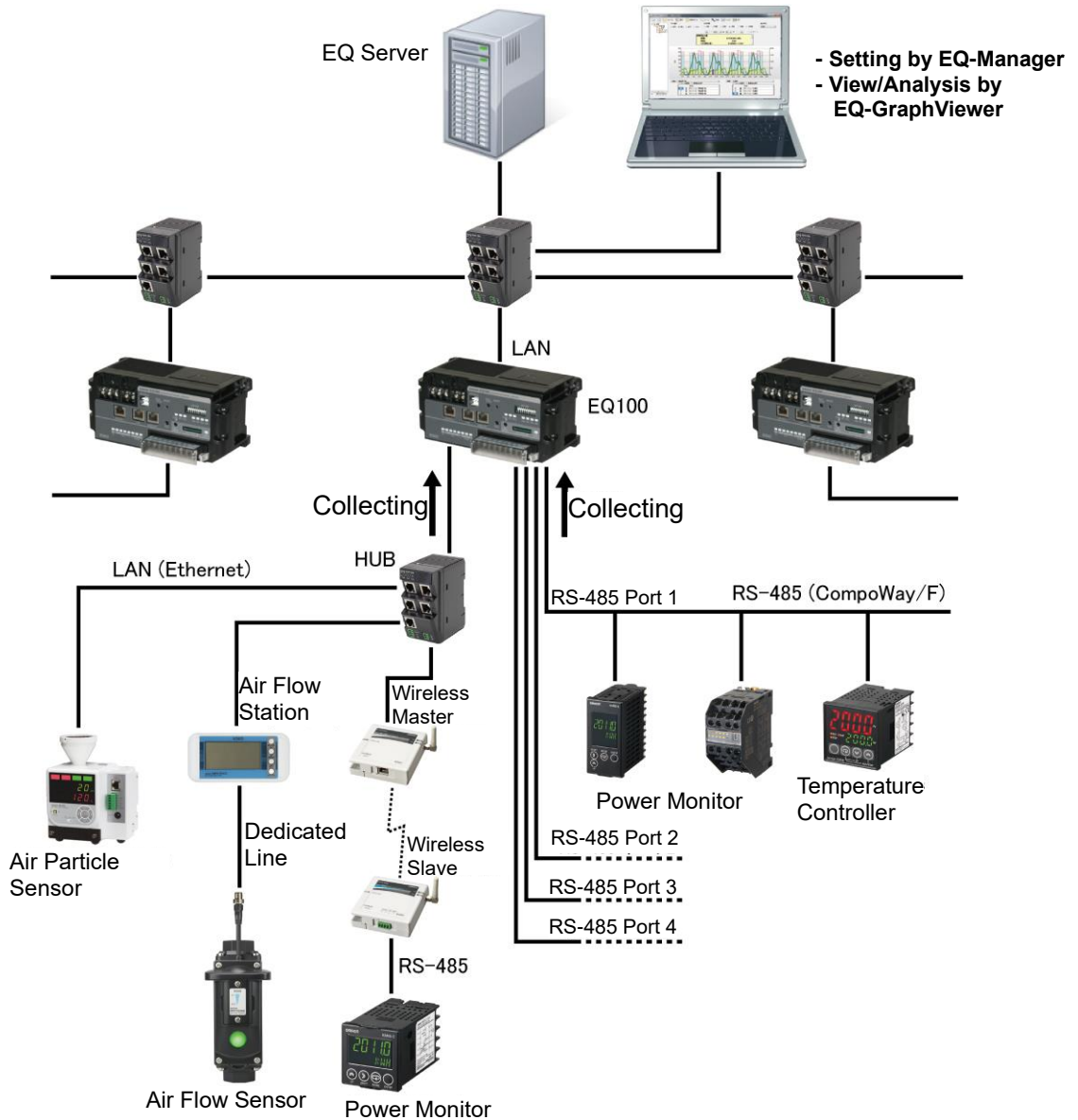

1.5.3. Configuration with FTP

Collected data saved in EQ100 is transferred using the FTP protocol based on a request from an upper level system. Collected data can be taken out in a specified period.

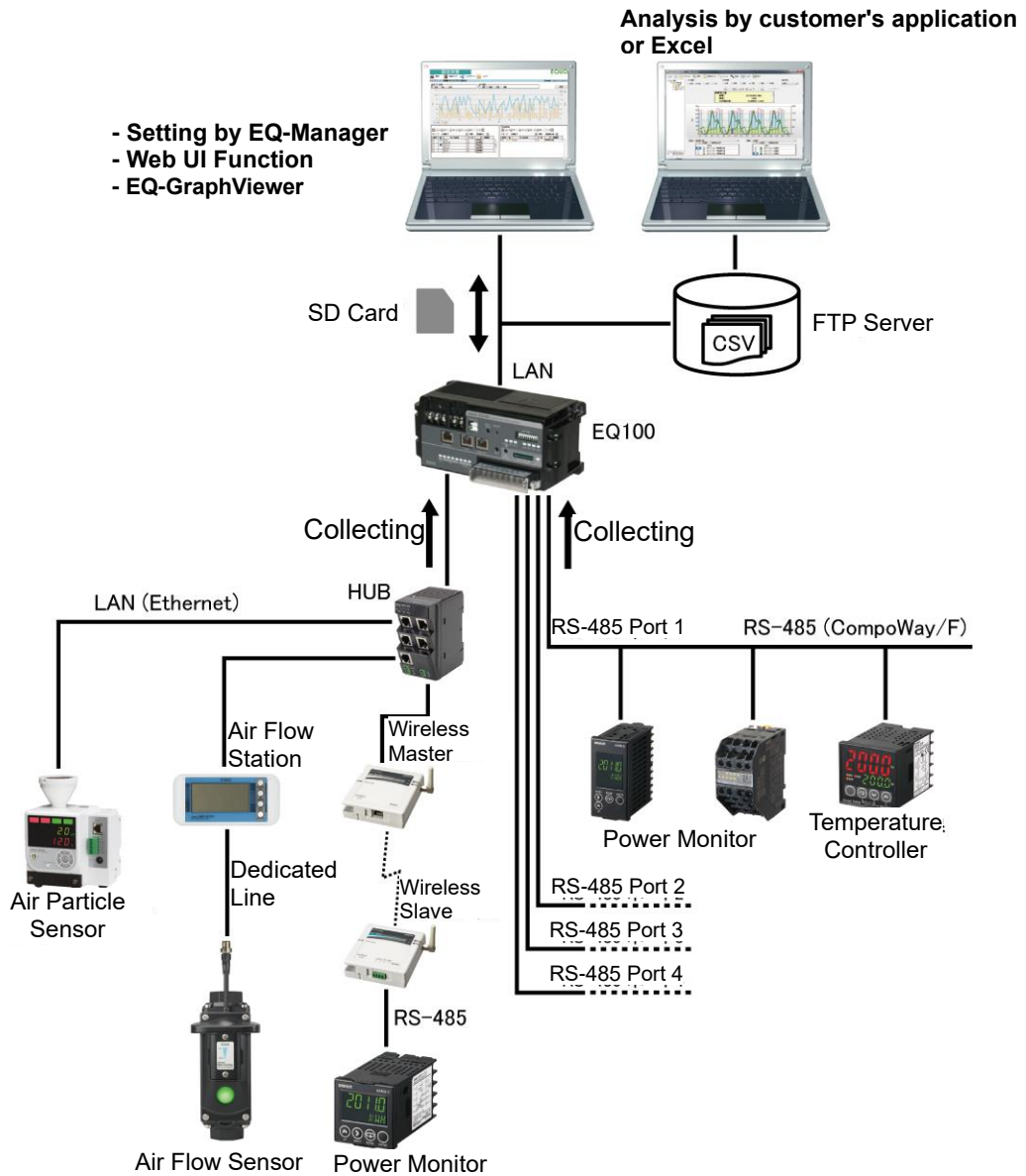

1.6. EQ100 Input/Output and Internal Configuration

There are two types of data collecting for EQ100: communications with measurement devices and pulse input from the general-purpose input terminal.

- Measured data can be collected from measurement devices connected through an RS-485 communications port and LAN connection port. (EQ100 internal input/output diagram, "a" part)
- Pulses from a device connected to the general-purpose input terminal of the EQ100 can be counted. (EQ100 internal input/output diagram, "b" part)

If an operation channel is configured, the measurement channel for operation is collected, operated, and stored. (EQ100 internal input/output diagram, "c" part)

The data are saved in the volatile memory with battery backup.

The Web UI function enables graph view and acquisition of collected data saved in EQ100. (EQ100 internal input/output diagram, "d" part)

EQ100 saves collected data once an hour into the internal memory. (EQ100 internal input/output diagram, "e" part)

The collected data are saved in the internal memory for one week. Collected data older than one week are overwritten by newly collected data from the oldest one. If none of the summary to EQ server, output to an SD card, and transfer to an FTP server is performed, collected data older than one week will be lost.

When enabled, the SD card output function outputs collected data to an SD card once a day. Or, you can output the data to an SD card any time by operating the SD card save button or Web UI screen. (EQ100 internal input/output diagram, "f" part)

Operation of the general-purpose output terminals and transmission of a monitoring alarm email is available when collected data meet the configured monitoring condition. (EQ100 internal input/output diagram, "g" and "h" parts)

A collected data file/event log file in the internal memory can be fetched by an FTP client (a collected data file in the SD card, if attached, can be fetched as well). (EQ100 internal input/output diagram, "i" part)

Enabling the FTP server transmission function allows transmission of collected data file in the internal memory to an FTP server. (EQ100 internal input/output diagram, "j" part)

■ EQ100 Internal Input/Output Diagram

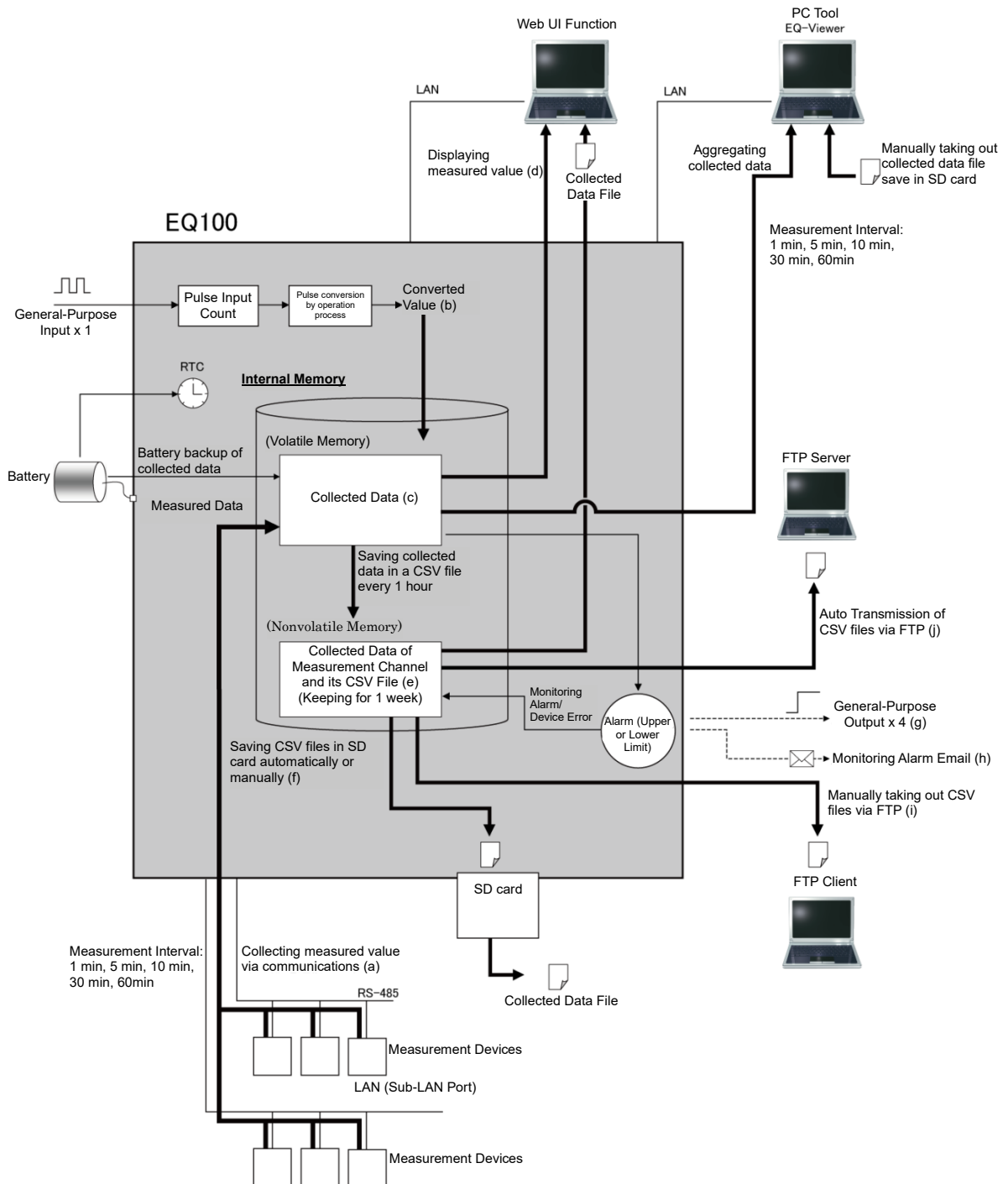

2. Specifications

2.1. Part Name

2.1.1. EQ100 Front End

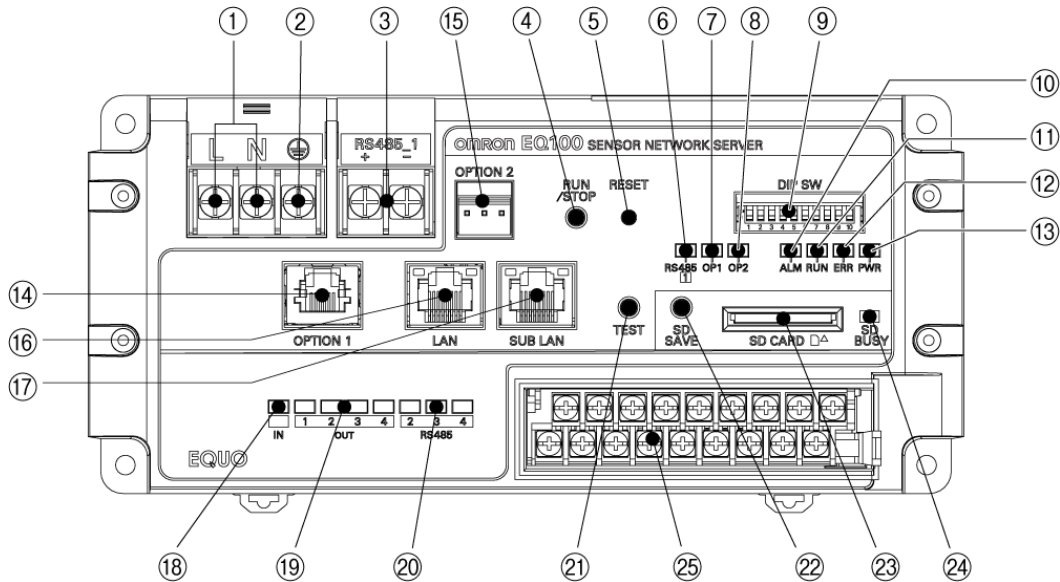

No.	Indication	Name	Function
1	L,N	Supply Terminal (M3.5 screw)	To connect to 100 to 240 VAC power source.
2	⊕	Grounding Terminal (M3.5 screw)	To connect to ground wire.
3	RS485_1	RS-485 Communications Port #1 Terminal (M3.5 screw)	To connect to RS-485-connected measurement device.
4	RUN/STOP	RUN/STOP Button	To switch between the setup and collecting statuses.
5	RESET	Reset Button	To restart after changing the setup.
6	RS485 ¹	RS485 Communications Port #1 Operation Indicator	To indicate an operation status of the RS-485 communications port #1.
7	OP1	OPTION1 Operation Indicator	(for future expansion)
8	OP2	OPTION2 Operation Indicator	(for future expansion)
9	DIP SW	Setup DIP Switch	To configure EQ100 operation.
10	ALM	Monitoring Alarm Indicator	To indicate a monitoring alarm status.
11	RUN	Collecting Status Indicator	To indicate an operation status of the EQ100 such as setup and collecting statuses.
12	ERR	Device Alarm Indicator	To indicate a device alarm status.
13	PWR	Operation Status Indicator	To indicate a power supply status and an operation mode.
14	OPTION1	OPTION1 Connection Port	(for future expansion)
15	OPTION2	OPTION2 Connection Port	(for future expansion)
16	LAN	LAN Connection Port (RJ-45)	To connect a LAN cable for the upper level system, a Web UI computer, or a LAN-connected measurement device.(*1)

2 Specifications

No.	Indication	Name	Function
17	SUB LAN	Sub-LAN Connection Port (RJ-45)	To connect a LAN cable for a LAN-connected measurement device or a Web UI computer. (*1)(*2)
18	IN	Input Status Indicator	Turns on when the general-purpose input is on.
19	OUT ¹ to ₄	Output Status Indicators	The indicators turn on when the general-purpose outputs 1 to 4 are on, respectively.
20	RS485 ² to ₄	RS-485 Communications Port #2 to 4 Operation Indicators	To indicate an operation status of the RS-485 communications ports #2 to 4.
21	TEST	Test Button	(for future expansion)
22	SD SAVE	SD Card Save Button	To output the collected data file to the SD card after the previous auto-save.
23	SD CARD	SD Card Slot	To attach the SD card available for EQ100.
24	SD BUSY	SD Card Access Indicator	This indicator turns on when a writable SD card is attached.
25	IN	General-Purpose Input Terminal (M3 screw)	To connect to an input device.
	OUT1 to 4	General-Purpose Output #1 to 4 Terminal (M3 screw)	To connect to an output device.
	RS485_2 to 4	RS-485 Communications Port #2 to 4 Terminal (M3 screw)	Terminals for RS-485 communications ports #2 to 4. To connect to RS-485-connected measurement device.
	FG	FG Terminal (M3 screw)	Terminal to connect the shield wire for RS-485 communications cable connected to RS-485 communications ports #2 to 4.

*1: Straight/crossover cable can be automatically identified. A shielded cable of category 5 or higher is recommended.

*2: For stable communications, it is recommended that a LAN-connected measurement device should be connected to the sub-LAN connection port.

2.1.2. EQ100 Top View

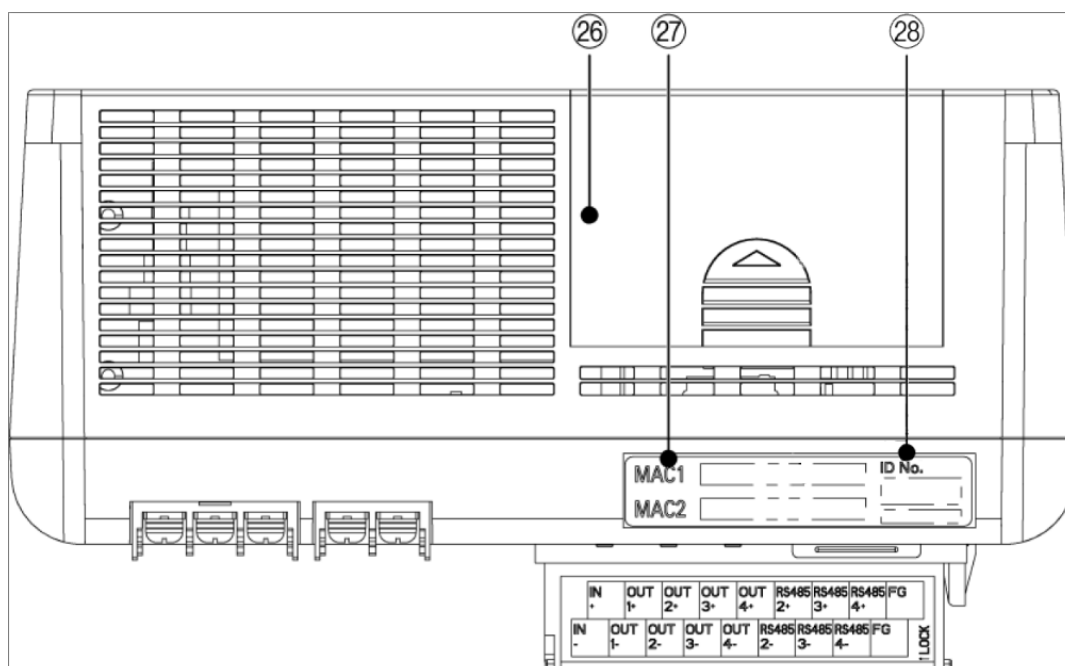

No.	Name	Function
26	Battery Compartment Cover	Inside this cover the memory backup battery is placed. The cover can be removed by sliding it backward while pressing its center.
27	MAC Address Label	On the label the MAC addresses of LAN connection port (MAC1) and sub-LAN connection port (MAC2) are printed (12-digit hexadecimal number).
28	SNC ID Label	SNC ID (6-digit number) is printed here. The described alphanumerical characters as ID No. are the one.

2.1.3. Button

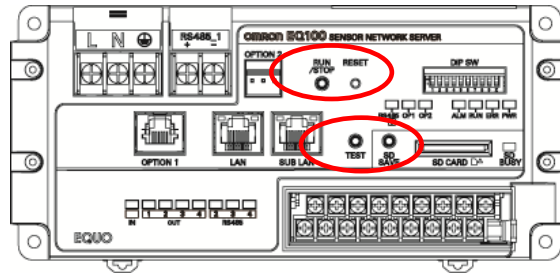

Indication	Execution Condition	Application	Response		
			Accept	Result	Others
RUN/STOP	Pressing the button (1 second or longer)	<ul style="list-style-type: none"> - Under setup status Press to proceed to the collecting status. - Under collecting status Press to proceed to the setup status. <p>* If the setup DIP switch SW9=ON, the RUN/STOP button is disabled.</p>	Yes	Yes	N/A
RESET	Pressing the button (1 second or longer)	<p>Press to restart EQ100.</p> <p>This is same as turning the power off and on again.</p>	Yes	Yes	N/A
SD SAVE	Pressing the button (1 second or longer, less than 5 seconds)	<p>Press the button to save the collected data file in the EQ100 internal memory to an SD card. Files that are not yet saved are outputted.</p> <p>At the same time the data not saved in the internal memory are saved into the internal memory.</p>	Yes	Yes	N/A
	Pressing and holding the button (5 second or longer)	<p>Press the button before ejecting the SD card from EQ100.</p> <p>When this operation is done, the function by pressing the button does not work. If you wish to save data to the SD card and eject the card, press the button (1 second or longer, less than 5 seconds) before performing this operation.</p>	Yes	Yes	SD card access indicator turns off
TEST		Not used			

* Accept: Buzzer sound (for 0.2 sec)

Result: Buzzer sound (for normal end for 4 sec, for abnormal end four times in 0.5 sec interval)

2.1.4. Indicator

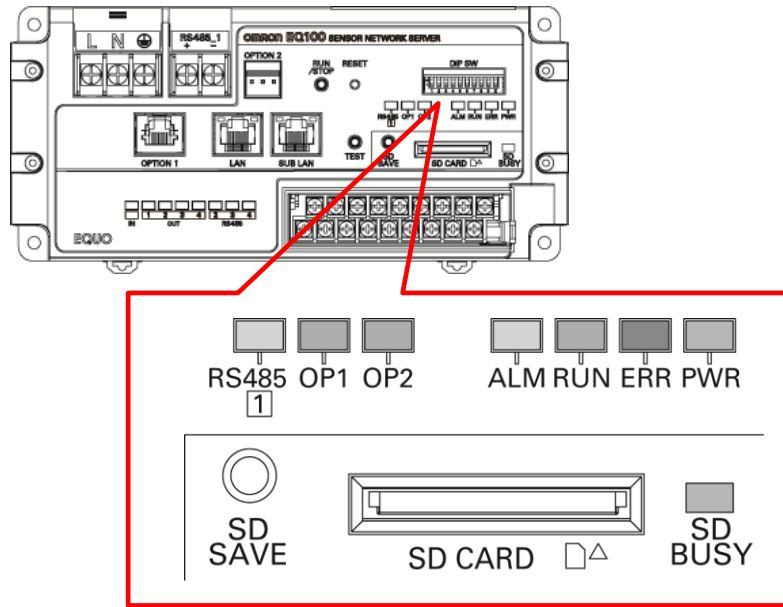

Indication	Name	Color	Status	Meaning
PWR	Operation Status Indicator	Green	ON	Operating under normal mode
			Flashing	Processing activation
			Special flashing	Operating under safe mode
			OFF	No power supply
ERR	Device Alarm Indicator	Red	ON	Instrument Failure: An error occurred and the device cannot be activated.
			Flashing	An error occurred upon installation/setup/connection and the device cannot work properly.
			Temporary ON	Communication Failure: A continuously processed error is detected.
			OFF	No error occurred
RUN	Collecting Status Indicator	Green	ON	Collecting
			Long flashing	Preparing for collecting
			OFF	Under setup, communication testing
ALM	Monitoring Alarm Indication	Yellow	ON	Monitoring alarm occurred
			OFF	No monitoring alarm occurred
RS485 ^①	RS-485 Communications Port #1 Operation Indicator	Yellow	ON	RS-485 communications port #1 is under operation.
SD BUSY	SD Card Access	Green	ON	A writable SD card is attached to the SD card slot.
			OFF	No SD card is attached to the SD card slot or the SD card is detached
OP1	Option 1	-	-	(for future expansion)
OP2	Option 2	-	-	(for future expansion)

* Indication status

- Flashing : Cycle of 0.25 seconds
- Long flashing : Cycle of 3 seconds
- Special flashing : Repeating flashing and on periodically

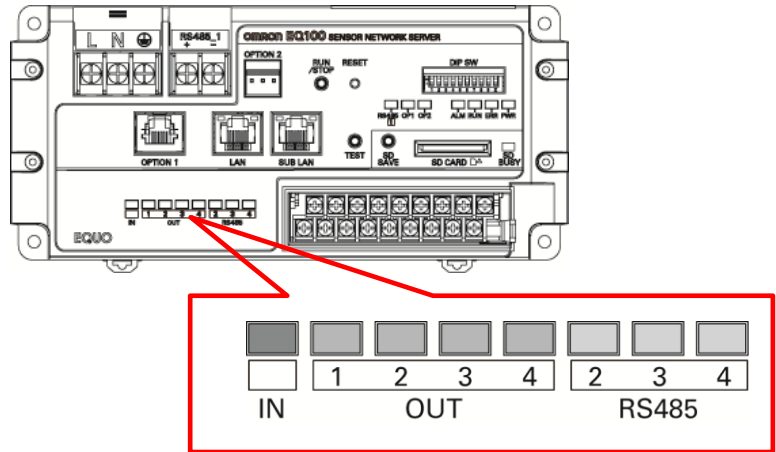

Indication	Name	Color	Status	Meaning
IN	General-Purpose Input Status Indicator	Orange	ON	The general-purpose input is on.
OUT ^①	General-Purpose Output 1 Status Indicator	Green	ON	The general-purpose output 1 is on.
OUT ^②	General-Purpose Output 2 Status Indicator	Green	ON	The general-purpose output 2 is on.
OUT ^③	General-Purpose Output 3 Status Indicator	Green	ON	The general-purpose output 3 is on.
OUT ^④	General-Purpose Output 4 Status Indicator	Green	ON	The general-purpose output 4 is on.
RS485 ^②	RS-485 Communications Port #2 Operation Indicator	Yellow	ON	RS-485 communications port #2 is under operation.
RS485 ^③	RS-485 Communications Port #3 Operation Indicator	Yellow	ON	RS-485 communications port #3 is under operation.
RS485 ^④	RS-485 Communications Port #4 Operation Indicator	Yellow	ON	RS-485 communications port #4 is under operation.

2.1.5. Connector/Terminal Name

● Power Supply Terminal

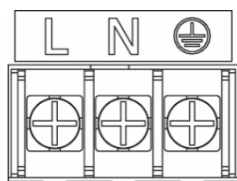

Terminal Block Screw Size: M3.5

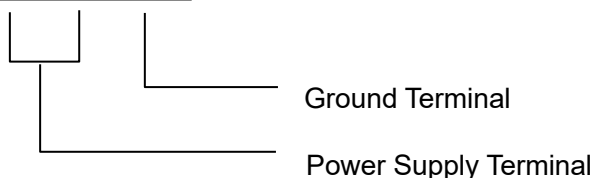

Name	Indication	Details
Power Supply Terminal	L	Supplies 100 to 240VAC.
	N	
Ground Terminal	⊕	For higher noise resistance and electric shock prevention, apply class D grounding (class 3 grounding). Connect the shield wire for RS-485 communications cable connected to RS-485 communications port #1 to this terminal.

● RS-485 Communications Port #1 Terminal

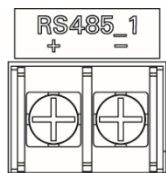

Terminal Block Screw Size: M3.5

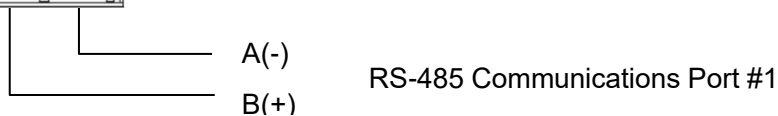

Name	Indication	Details	
RS-485 Communications Port #1 Terminal	RS485_1	+	Terminal to connect the communications cable between RS-485 communications ports #1 and an RS-485-connected measurement device.
		-	

- General-purpose input, general purpose outputs #1 to 4, RS-485 communications ports #2 to 4, FG terminals (terminal block)

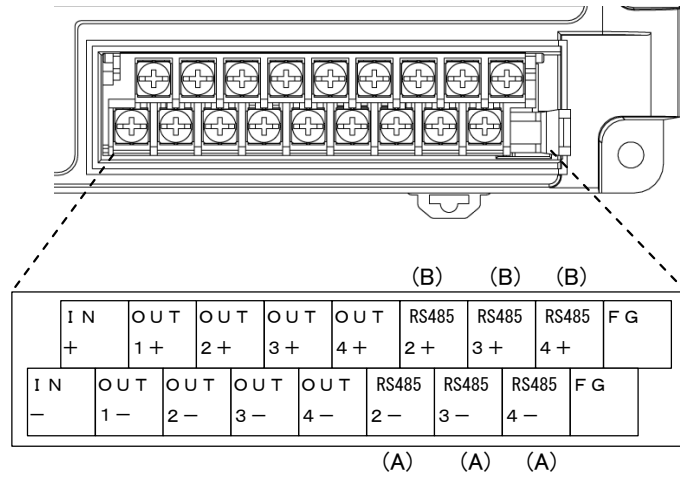

Name	Indication	Details
General-Purpose Input Terminal	IN+	Terminal for general-purpose input. To connect to pulse output of a measurement device.
	IN-	
General-Purpose Output 1 Terminal	OUT1+	Terminal for general-purpose output 1.
	OUT1-	
General-Purpose Output 2 Terminal	OUT2+	Terminal for general-purpose output 2.
	OUT2-	
General-Purpose Output 3 Terminal	OUT3+	Terminal for general-purpose output 3.
	OUT3-	
General-Purpose Output 4 Terminal	OUT4+	Terminal for general-purpose output 4.
	OUT4-	
RS-485 Communications Port #2 Terminal	RS485_2+	Terminal to connect the communications cable between RS-485 communications ports #2 and an RS-485-connected measurement device.
	RS485_2-	
RS-485 Communications Port #3 Terminal	RS485_3+	Terminal to connect the communications cable between RS-485 communications ports #3 and an RS-485-connected measurement device.
	RS485_3-	
RS-485 Communications Port #4 Terminal	RS485_4+	Terminal to connect the communications cable between RS-485 communications ports #4 and an RS-485-connected measurement device.
	RS485_4-	
FG Terminal	FG	Terminal to connect the shield wire for RS-485 communications cable connected to RS-485 communications ports #2 to 4. The FG terminal is electrically connected to the grounding terminal.

● LAN Connection Port

A port to connect a LAN cable for the upper level system (EQ server, EQ-Manager, SMTP server, SNTP server, FTP client) or a Web UI computer. A measurement device can be connected as well.

A commercial LAN cable for 10BASE-T/100BASE-T can be used (shielded cable of category 5 or higher is recommended).

A straight or crossover cable can be identified automatically when connected.

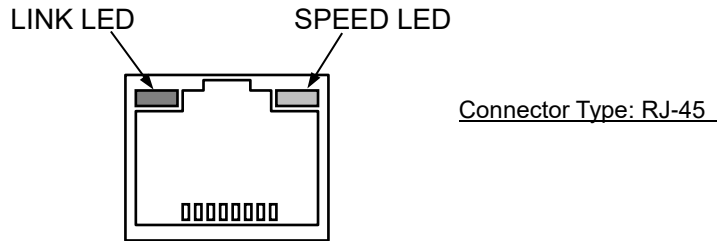

LED Name	Color	Status	Description
LINK	Green	ON	(Normal) link established
		Flashing	Communicating
SPEED	Orange	ON	Connected at 100 Mbps
		OFF	Connected at 100 Mbps, or not connected

● Sub-LAN Connection Port

A port to connect a LAN cable for a LAN-connected measurement device or a Web UI computer.

A commercial LAN cable for 10BASE-T/100BASE-T can be used (shielded cable of category 5 or higher is recommended).

A straight or crossover cable can be identified automatically when connected.

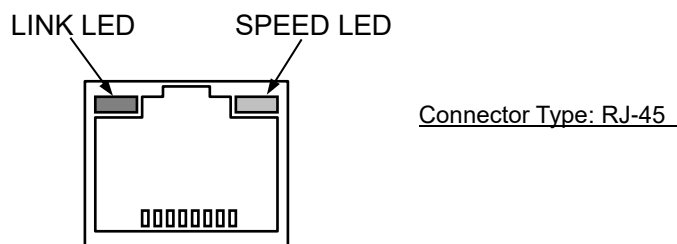

LED Name	Color	Status	Description
LINK	Green	ON	(Normal) link established
		Flashing	Communicating
SPEED	Orange	ON	Connected at 100 Mbps
		OFF	Connected at 100 Mbps, or not connected

Precautions for Correct Use

- To the sub-LAN port, an upper level system (EQ server, SMTP server, SNTP server, and FTP server) cannot be connected.

2.1.6. DIP Switch

DIP SW

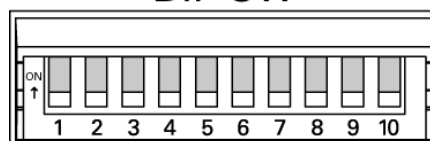

No.	Item	Setting	Priority	Remarks
1	(Not used)	Set to Always OFF.	-	-
2	(Not used)			
3	(Not used)			
4	(Not used)			
5	(Not used)			
6	(Not used)			
7	Write an EQ project	ON(*)	3	Set before turning on the power or resetting.
		OFF		
8	Update firmware	ON(*)	2	Set before turning on the power or resetting.
		OFF		
9	Limit RUN/STOP button	ON	-	Can be set any time.
		OFF		
10	Startup Mode	ON(*)	1	Set before turning on the power or resetting.
		OFF		

* Always set to ON only one of the setup DIP switches SW7, SW8, and SW10. Do not set two or more switches ON.

* When either of the setup DIP switches SW7, SW8, or SW10 is ON, EQ100 cannot collect data. To collect data, set all of SW7, SW8, and SW10 to OFF, then reset or restart the device.

Reference

- For configuration of the setup DIP switches, see "3. Operation Mode and Status".

2.1.7. SD Card Slot

The SD card access indicator turns on when a writable SD card is attached to the SD card slot while EQ100 is operating. If the SD card access indicator does not turn on when the SD card is attached, the card may be write-protected or not supported by EQ100.

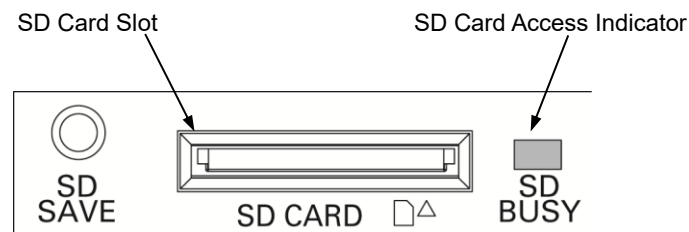

Precautions for Correct Use

- The retention period of data convergence in the EQ100's internal memory is one week (collected data older than one week are overwritten by newly collected data from the oldest one).
- To keep collected data older than one week in EQ100, use an SD card to save.
- The SD card output may take a long time from the operation to output to finish, depending on the amount of data to save. Before ejecting the SD card, check the Web UI screen message and/or buzzer sound for the completion of output.

2.1.8. Memory Backup Battery

This product has a battery for memory backup to keep collected data and built-in clock upon blackout.

The battery is attached inside the top cover, while the battery connector is not attached upon factory shipment. Before using the product, attach the battery connector and place the cable as shown in the figure (see "5.2. Battery Connection"). After connecting the battery, remove the memory backup battery caution label on the top of the EQ100.

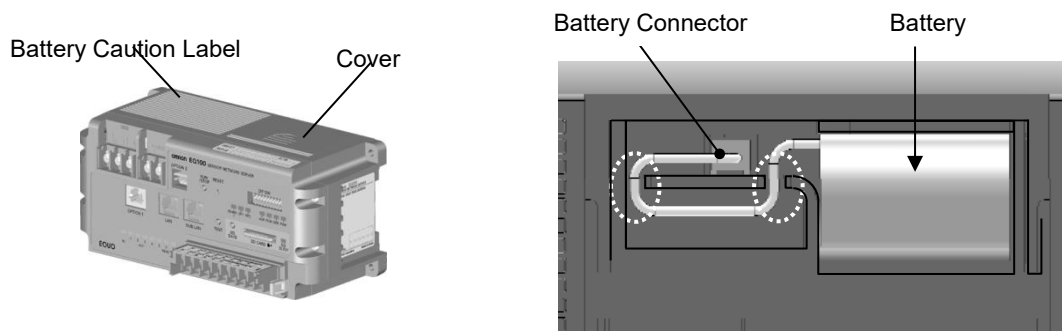

Precautions

- Before installing the EQ100, always attach the memory back up battery. Otherwise proper data collecting may not be available upon blackout or power off, due to reset of the built-in clock, loss of totalized information, and/or loss of collected data of the latest 1 hour.

 **WARNING**

A lithium battery is used for memory backup. Do not disassemble, apply pressure to deformation, overheat to more than 100°C, and/or burn it.

Otherwise serious injury may occasionally occur due to fire and/or explosion.



* Battery Life

- The battery life is around 5 years (at ambient temperature of 23°C), largely depending on the operating conditions. This life value is only a reference one and is not guaranteed.
- When a low battery is detected, the device alarm indicator on the EQ100 front end flashes. Replace the battery within two weeks from the low battery detection.

* Purchase of New Battery

- For purchase of a new memory backup battery, contact our sales representative.

Product Name : Memory backup battery
Model : CP1W-BAT01
Product Code : CP1W-0101E

Precautions for Correct Use

- The memory backup battery is a consumable item. When the battery's remaining capacity becomes low, the device alarm indicator on the product's front end turns on and the battery must be replaced to new one.
- Turn off the power before replacing the battery. Attach a new battery within five minutes from turning off the power. Otherwise the stored data may become indefinite.
- If you do not use the product for a long period of time, remove the battery. This should prevent battery consumption and a failure due to leak.

2.2. Ratings and Performance

2.2.1. Hardware Specifications

Item		Details
Supply Voltage		100 to 240 VAC 50/60 Hz
Allowable Power Supply Voltage Range		85 to 264 VAC 50/60 Hz
Power Consumption		15VA or less
LAN and sub-LAN	Ports	2 ports
	Interface	10BASE-T/100BASE-TX
	Connector	RJ-45
	Transmission Rate	10 M/100 Mbps
	Type	CSMA/CD
	Cascaded Stages	10BASE-T: Up to 4 stages, 100BASE-TX: Up to 2 stages (for a repeater hub in both)
	Transmission Distance	100 m
	Other Functions	Automatic crossover/straight identification, AutoNegotiation
RS-485	Ports	4 ports
	Communications Protocol	CompoWay/F, Modbus RTU
	Maximum Connections	31 devices for 1 port (total for the device: 31 devices × 4 ports = 124 devices)
	Terminal Resistor	Built-in (120 Ω)
	Communication Speed	9.6 k/19.2 k/38.4 kbps (factory shipment: 9.6 kbps)
	Data Length	7/8 bits (factory shipment: 7 bits)
	Stop Bits	1/2 bits (factory shipment: 2 bits)
	Vertical Parity	None/Even/Odd (factory shipment: Even)
General-Purpose Input	Inputs	1 input
	Function	Pulse input
	Input Voltage	10.2 to 26.4 VDC
	Input Impedance	Approx. 2.2 kΩ
	Input Current	12 VDC/5 mA (TYP), 24 VDC/10 mA (TYP)
	ON Voltage	10.2 VDC or higher
	OFF Voltage	5.0 VDC or less
	Input Pulse Width	5 ms or longer
General-Purpose Output	Count	4 outputs
	Function	Monitoring alarm output
	Maximum Load Voltage	30 VDC
	Maximum Load Current	50 mA/output
	ON Resistance	5 Ω or less
Insulation Resistance (*)		Between power terminals and FG terminal: 20 MΩ or higher (500 VDC) Between power terminals and general-purpose input, general purpose outputs #1 to 4, RS-485 communications ports #1 to 4, LAN, sub-LAN, OPTION1, and OPTION2: 20 MΩ or higher (500 VDC) Between ground, FG terminal and OPTION1, OPTION2: 20 MΩ or higher (500 VDC)

2 Specifications

Item	Details
Withstand Voltage (*)	Between power terminals and FG terminal: 1500 VAC for 1 minute Between power terminals and general-purpose input, general purpose outputs #1 to 4, RS-485 communications ports #1 to 4, LAN, sub-LAN, OPTION1, OPTION2: 1500 VAC for 1 minute Between ground, FG terminal and OPTION1, OPTION2: 500 VAC for 1 minute
Vibration Resistance (*)	10 to 150Hz: Half amplitude of 0.1mm, acceleration of 15 m/s ² , for each of 3 axes of 8 minutes x10 sweeps
Shock Resistance (*)	150 m/s ² 6 directions of up, down, right, left, forward, and back, 3 times each
Operation Ambient Temperature (*)	-10 to +55°C
Operation Ambient Humidity (*)	25 to 85% RH (no freezing and no condensation)
Storage Ambient Temperature (*)	-25 to +65°C (excluding batteries)
Storage Humidity	25 to 85% RH
Degree of Protection	IP20
Supported Memory Card	SD card (optional, up to 2GB) SDHC card (optional, up to 32GB) (SDXC card is not supported and cannot be used) Supported Format: FAT 16 for SD card, FAT32 for SDHC card Recommended product: HMC-SD491 (4GB), HMC-SD291 (2GB) If you are using a third-party card, SD card for industrial use is recommended.
Data Protection of Internal Volatile Memory	Lithium battery, life: 5 years (reference value, at ambient temperature of 23°C)
Built-In Clock	Supporting leap years from 2010 to 2099 Precision: ±40 sec/month (at ambient temperature of 23°C)
Size	W200 × H91 × D88 (mm) (except for terminal blocks and protrusions) (W200 × H95.35 × D109 (mm) including terminal blocks and protrusions)
Weight	Approx. 0.7 kg
Accessories	Operation Manual Startup Guide Memory backup battery (installed inside the top panel of the EQ100) Memory backup battery caution label (attached on top of the EQ100) LAN connector dustproof cover (attached) Sub-LAN connector dustproof cover (attached) OPTION1 connector dustproof cover (attached) Dummy SD card for dustproof (attached to the SD card slot) CD-ROM (containing graph display tool and related documentation)
Others	Unused interface - OPTION1 connector - OPTION2 connector

*: When an SD card is not attached

2.2.2. Software Specifications

Item		Details	
Operation Mode	Normal Mode	There are following three modes when operated normally:	
		Setup Status	A status to configure the EQ100, register a measurement device, and perform communication test.
		Collecting Status	A status to collect and monitor energy data. Under the collecting status, the setup cannot be changed.
	System Error Status	A status under which an instrument failure occurred and no operation is available for the setup and collecting statuses.	
	Safe Mode	A mode to recover from disaster or perform device maintenance.	
Data Collecting Function	Target Device	See "2.3. Supported Devices".	
	Communications Path for Collecting	There are following two communications path for data collecting: - RS-485 communications × 4 (communications protocol: CompoWay/F, Modbus RTU) - LAN communications × 2	
	Maximum Measurement Channels	Up to 500 channels (with limitations based on measurement device type and collecting interval)	
	Collecting Interval	1 min/5 min/10 min/30 min/60 min	
Pulse Input	Function	The number of pulses inputted during the collecting interval is counted and saved to the pulse (input) channel. Based on the pulse input count channel, its unit is converted to an engineering unit (mainly energy unit) by created operation expression.	
Logging Function	Target data, logging interval, stored memory	The following two data types are logged: - Collected Data Data collected from a measurement device is saved into the internal memory. - Event Log Logs of EQ100 monitoring alarm, device alarm, and internal events are saved into the internal memory as an event log.	
	How to Start Saving into Internal Memory	Any of the following operations starts collecting and saving of the log when the status transfers from the setup to collecting: - Operation of collecting start on the Web UI screen - Operation of logging start on EQ-Manager - Pressing RUN/STOP button on the EQ100 front end	
Setup Function	EQ100 Setting	An EQ project is loaded that is created by EQ-Manager. An EQ project is loaded by any of the following operations: - Setup write function of EQ-Manager to write the EQ project from a computer to EQ100. - To attach an SD card containing an EQ project file to EQ100 and write the EQ project. - Web UI operation to write the EQ project from a computer to EQ100.	
Time Synchronization	Synchronization with EQ Server	Synchronizes the time with EQ server.	
	Synchronization with SNTP Server	Synchronizes the time with SNTP server.	
Internal Event	Function	A normal event occurrence other than monitoring alarm and device alarm is collected into the internal memory.	
	Log to Internal	An occurred event is saved into the internal memory. The	

2 Specifications

Item		Details
	Memory	event log can be checked on the Web UI screen and outputted as an event log file.
	File Output	An event is outputted as an event log file.
Network Connection	Connection Function	LAN connection port: Upper level system (EQ server, EQ-Manager, SMTP server, SNTP server, FTP server, FTP client), a computer (Web browser), measurement device Sub-LAN connection port: Measurement device, computer (Web browser)
Web UI Function		A user can view a status, operate the EQ100, view simple graph, and perform maintenance through a Web browser on a computer connected to the LAN or sub-LAN connection port.
Taking Out Internal Data File		The following four operations are available:
	(1) Collecting by EQ Server	The EQ server collects data and event logs saved in the EQ100 internal memory via network.
	(2) Operation on Web UI Screen	Collected data or event log saved in the EQ100 internal memory is downloaded by operation on the Web UI screen.
	(3) SD Card Output	Any of the following operations outputs collected data and log files saved in the EQ100 internal memory to an SD card. - Pressing SD card save button on the EQ100 front end - Web UI operation: SD card data output operation If the SD card output setting is configured as "Yes", collected data saved in the EQ100 internal memory is saved on an SD card once a day.
	(4) FTP transfer	FTP server and FTP client functions are available. - FTP server function: Acquires collected data files saved in the EQ100 internal memory via an FTP client and collected data on an SD card attached to EQ100 or an event log. - FTP client function: Sends collected data files saved in the EQ100 internal memory to the FTP server from EQ100.
Monitoring Alarm	Function	Alarm when collected data exceeds upper or lower limit. Output to a general-purpose output terminal is available as well.
	Email Notification	Function: Monitoring Alarm Email
	Log to Internal Memory	An occurred monitoring alarm is saved into the internal memory. The event log can be checked on the Web UI screen and outputted as an event log file.
	Status Indication	Monitoring alarm indicator is turned on
Device Alarm Detection	Function	Detects an instrument failure of EQ100, setup/status, device, communications, and/or monitoring process.
	Email Notification	Function: Device alarm email
	Status Indication	Turns on, flashes, long-flashes, or turns temporarily on the device alarm indicator
	Log to Internal Memory	An occurred device alarm is saved into the internal memory. An event can be outputted as an event log file.
Contact Output	Function	An alarm can be outputted to a general-purpose output terminal when a monitoring condition is met.
Email Notification	Function	- Monitoring alarm notification email: Sent upon a monitoring alarm occurrence.

2 Specifications

Item		Details
		<ul style="list-style-type: none"> - Device alarm notification email: Sent upon an occurrence of an instrument failure, setup/status, device, communications, and/or monitoring process of EQ100. - Periodic alarm: Sent at a specified hour with a body configured by a user. - Test email: Sent by a Web UI operation to check the configured email notification of the communications status with the SMTP server. <p>* The SMTP function with email transmission authentication supports:</p> <ul style="list-style-type: none"> • POP before SMTP • POP before SMTP (APOP) • SMTP AUTH PLAIN
Maintenance Function	Communication Test	Communications with connected measurement devices are continuously performed to check stability of the communications with measurement devices. Collected data are not saved.
	Clock Setup	The time is configured for the built-in clock of the EQ100.
	General-Purpose Output	The general-purpose output terminals are operated between on and off.
	FTP Test Transfer	FTP transfer from the EQ100 to the FTP server is tested.
	Firmware Update	<p>The firmware of the EQ100 is updated. The firmware can be updated by any of the following operations:</p> <ul style="list-style-type: none"> - Web UI operation to transfer the firmware from a computer to EQ100 to update. - Attaching an SD card containing the firmware to update. - Safe mode function to transfer the firmware from a computer to EQ100 to update.

■ EQ100 Output File

The following data are saved in the internal memory as EQ100 output files.
Some files are created by collecting and EQ project files are created by EQ-Manager.

● Files created by EQ100

Yes: Available, N/A: Not available

File	Details	Save Timing	How to Take Out			
			SD Card	Web UI Operation	FTP Server Transfer	FTP Client Fetching
Collected Data File	A measurement data file collected from measurement devices	To the internal memory, once an hour (*1)	Yes (*2)	Yes	Yes	Yes
	User-specified measurement data file	Saved in the internal RAM in a user-specified interval	N/A	Yes	Yes	Yes
Event Log File	A log file of internal events such as monitoring alarm, device alarm, and status changes	Saved in the internal memory upon an occurrence of monitoring alarm, device alarm, or an internal event	N/A	Yes	N/A	Yes

*1: Manual saving of collected data to an SD card saves collected data including the latest one right before the operation.

*2: Automatic save is available as well as manual saving by SD card output button or Web UI operation.

● EQ Project File

Yes: Available, N/A: Not available

File	Details	Save Timing	Write		Load	
			EQ-Manager	SD Card	EQ-Manager	SD Card
EQ Project File	Configuration information and operation settings of measurement devices connected to EQ100	Write from EQ-Manager or an SD card	Yes	Yes	Yes	Yes

■ Relation between Internal Data, Internal Storage, and External Output

Internal data of EQ100 are saved or outputted in the following forms:

Yes: Available, N/A: Not available

Input/Output	Internal Save	External Output		
EQ100 Internal Data	Log to Internal Memory	Contact Output	Email Notification	Save to Event Log
Monitoring Alarm	Yes	Yes	Yes	Yes
Internal Event	Yes	N/A	N/A	Yes
Device Alarm Information	Yes	N/A	Yes	Yes
Periodic Report	N/A	N/A	Yes	-

■ Available SD Card Memory Capacity

Available memory capacity of an SD card depends on a collecting interval, measurement channels, and storage duration.

e.g.) In case of a collecting interval of 1 minute and 500 measurement channels, based on storage durations the memory capacities to save on an SD card are shown below.

> For an SDHC card of 32GB, the capacity is for 3.5 years.

File Type	Measurement Condition			Memory Capacity to Save
	Collecting Interval	Measurement Channels	Storage Duration	
Collected Data File	1 minute	500 channels	1 hour	0.4 Mbytes
			6 hours	2.2 Mbytes
			12 hours	4.5 Mbytes
Collected Data File and Binary Log (*)			1 day	20.1 Mbytes (For collected data file: 8.9 Mbytes)
			1 week	140.7 Mbytes (For collected data file: 62.5 Mbytes)
			1 month	623 Mbytes (For collected data file: 276.7 Mbytes)
	1 year	7.2 GB		

*: A binary log is data for graph view used in the system. It is automatically saved if the storage duration is 1 day or longer.

2.3. Supported Devices

EQ100 collects various energy data from pulse input, RS-485-connected measurement devices, LAN-connected measurement devices, wireless device units, or PLC. Supported collecting intervals are 1, 5, 10, 30, and 60 minutes. Available measurement devices for EQ100 are:

Device Type	Connection Method	Model	Name
Pulse Input (*1)	IN (General-Purpose Input Terminal)	-	-
RS-485-Connected Measurement Device	RS-485	KM-N1-FLK	Smart Power Monitor
		KM-N2-FLK	Power Monitor
		KM-N3-FLK	Power Monitor
		KM20-B40-FLK	Smart Power Monitor
		KM100-T□-FLK(*2)	Power Monitor
		KM50-□-FLK(*6)	Smart Power Monitor
		KM1-PMU1A-FLK	Power Measurement Unit
		KM1-PMU2A-FLK	Dual Power System Measurement Unit
		KM1-EMU8A-FLK	Pulse/Temperature Input Unit
		KE1-CTD8E	CT Expansion Unit
		K3GN-□□□-FLK	1/32 DIN Digital Panel Meter
		K3HB-□□□-FLK3	Digital Panel Meter
		E5□C(*3)	Digital Temperature Controller
Modbus RTU Device	RS-485	-	-
LAN-Connected Measurement Device	LAN	ZN-PD□□-S□	Air Particle Sensor
		ZN-THX21-S□(*2)	Air Thermo Station
		ZN-CTX21(*2)	Portable Power Monitor
		ZN-KMX21(*2)	Power Sensor Station
		ZN-DPX21-S□(*2)	Differential Pressure Station
		D6FZ-FGX21(*2)	Air Flow Station
PLC(*4)(*7)	LAN	-	-
Wireless Device Unit	LAN	WZ-MLAN01	Wireless Unit Master
	None (*5)	WZ-SRS01	Wireless Unit Slave (CompoWay/F)
		WZ-STH01	Wireless Device Thermo-Humidity Sensor
		WZ-SL01	Wireless Device Light Intensity Sensor
		WZ-STHL01	Wireless Device Thermo-Humidity Light Intensity Sensor
		WZ-SCD01	Wireless Device CO ₂ Sensor
		WZ-SP01	Wireless Unit Slave (Pulse Count)

- *1: Pulse input can accept a pulse of 5ms ON/OFF as the shortest one. A power supply of 12 or 24VDC is separately required.
- *2: A measured value of a measurement device with the data logging function and a measured value of EQ100 may not be the same.
- *3: E5CC and E5EC with RS-485 communications function are supported.
- *4: OMRON's CPU unit with CJ series EtherNet/IP port and EtherNet/IP unit are supported.
- *5: No connection interface with EQ100 as EQ100 collects data via WZ-MLAN01.
- *6: KM50-□-FLK has limitations on measurable parameters depending on the sensor software version. For details, see EQ-Viewer manual "Appendix/Measurement Device Channel List".
- *7: OMRON's NJ series and NX1P Series.

Described above are supported devices as of the time of the creation of this manual.

For the latest information of supported devices, see the latest EQ100 user's manual.

<http://www.fa.omron.co.jp/>

Precautions for Correct Use

Caution on PLC Connection

- The 4th octet of the PLC's IP address and that of EQ100's LAN connection port must not be matched. This also applies even if the PLC is connected to the sub-LAN connection port.
- Make sure that the 4th octets of IP addresses are unique when multiple PLCs are connected.
- If either "Operation Stop Error" or "Operation Continuation Error" occurred in PLC's CPU unit, EQ100 does not perform logging from the PLC.
If "Low Battery" error occurred in a CPU unit, for example, "Operation Continuation Error" occurs and the EQ100 does not record data from the PLC. Replace the CPU unit's battery before "Low Battery" occurs.
- * The 4th octet of an IP address is, for example, xxx of 192.168.250.xxx.
- * An error due to operation continuation failure does not occur for EQ100 of the firmware version 1.160 or later.

Reference

- A measurement device that can log measured data by itself, e.g. KM100 and ZN-KMX21, logs measured data with its internal clock. EQ100 collects measurement data using its internal clock from measurement devices.

Collecting of measured data by a measurement device itself and EQ100 are separately performed. The measured data of them may not be the same due to a difference between the measurement timings.

■ Device Type and Maximum Measurement Channels

The maximum number of measurement channels of EQ100 is 500, including all measurement devices and operation channels.

Under the limitation, shown below is a list of the maximum numbers of measurement channels for measurement devices:

Connection Method	Device Type	Device Name	Maximum Connections	Maximum Measurement Channels	
				Collecting Interval: 1 minute	Collecting Interval: 5 minutes or longer
RS-485	RS-485-Connected Device	- Power Monitor - Digital Panel Meter - Temperature Controller	124 devices (31 devices/port x 4 ports)	160 channels (40 channels/port)	500 channels (200 channels/port)
LAN	LAN-Connected Device	- Portable Power Monitor - Air Thermo Station - Differential Pressure Station - Air Particle Sensor - Power Station - Air Flow Station	100 devices	500 channels	500 channels
	Wireless Device Unit	- Wireless Unit Slave (CompoWay/F)	30 devices (*1) (14 devices/slave)	40 channels	120 channels
		- Air Thermo Sensor - Illumination Sensor - Air Thermo Illumination Sensor - CO ₂ Sensor - Wireless Unit Slave (Pulse Count)	30 devices (*1)	Limitless in the channel number (only the number of devices to be connected is limited)	
	PLC	- CJ Series - NJ Series - NX1P Series	10 devices (*2)	500 channels	500 channels
Pulse Input		-	1 input	1 channel	1 channel
Operation Channel		(A channel obtained by a process operating a measurement channel)	-	100 channels	100 channels

*1: The number of wireless device units is counted as the number of the slave units, regardless of the number of LAN-connected master units and relay units.

*2: Make sure that the 4th octets of IP addresses are unique when multiple PLCs are connected, including EQ100's LAN connection port.

* The 4th octet of an IP address is, for example, xxx of 192.168.250.xxx.

2.4. Network

■ Network Specifications

Shown below are EQ100 network specifications:

Item	Specifications		
Interface	Ethernet		
Ports	2		
Connector	RJ-45		
Type	CSMA/CD		
Modulation	Baseband		
Standards	10BASE-T/100BASE-TX		
		10BASE-T	100BASE-TX
	Transmission Rate	10Mbps	100Mbps
	Transmission Media	Twisted-pair cable (unshielded: UTP): Category 3, 4, 5, or 5e Twisted-pair cable (shielded: STP): Category 3, 4, 5, or 5e, 100 Ω	Twisted-pair cable (unshielded: UTP): Category 5 or 5e Twisted-pair cable (shielded: STP): Category 5, or 5e, 100 Ω
	Cascaded Stages (*)	Up to 4 stages	Up to 2 stages
Transmission Distance	100 m		
Others	Automatic crossover/straight cable identification AutoNegotiation		

*: In case of a repeater hub

■ LAN and Sub-LAN Connection Port

Differences of LAN and sub-LAN connection ports are shown below:

R: Recommended, Yes: Available, N/A: Not available

Specifications		LAN	Sub-LAN
Setting Item	Default Gateway	Yes	N/A
	DNS	Yes	N/A
Connection Device	Upper Level System (*1)	Yes	N/A
	Computer (Web Browser)	Yes	Yes
	Measurement Device (*2)	Yes	R

*1: Upper level systems include EQ server, EQ-Manager, mail (SMTP) server, SNTP server, FTP server, and FTP client.

*2: It is recommended that a LAN-connected measurement device should be connected to the sub-LAN connection port to configure a network dedicated to measurement devices. Shown below are advantages to construct a dedicated measurement device network:

- Influence of high network load on measured data collecting can be avoided
- Influence of an instrument failure on other devices can be avoided
- Influence of power cut of a network device on measured data collecting can be avoided

2.5. Dimensions

■ Top View

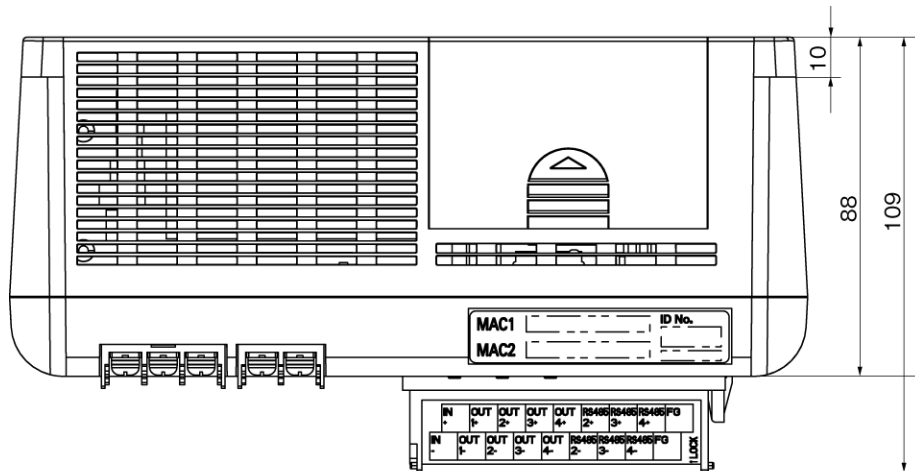

■ Front View

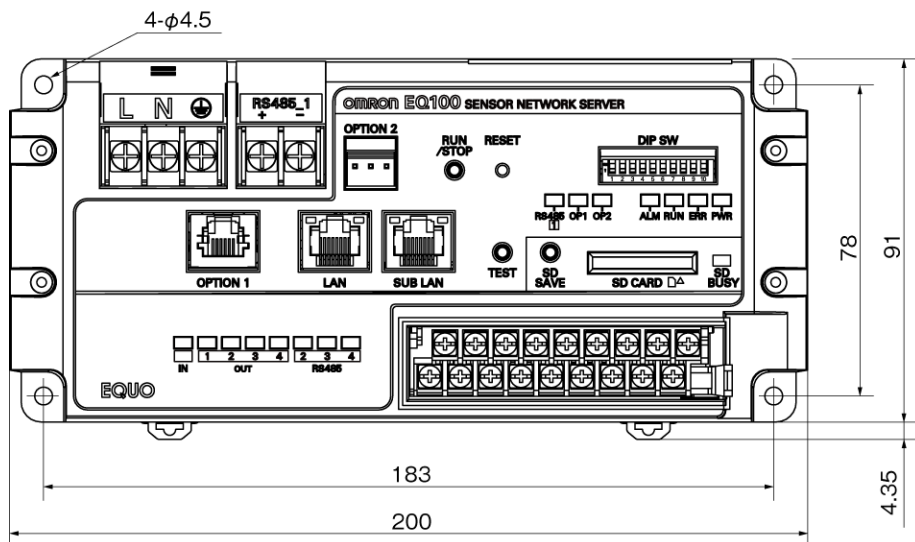

(Unit: mm)

3. Operation Mode and Status

3.1. Operation Mode

EQ100 has normal mode and safe mode as its operation mode.

The normal mode is a status under which the system is properly running as a sensor network server. The safe mode is for maintenance to recover from a disaster.

EQ100 is activated under the safe mode if the setup DIP switch SW10 is ON. Under the safe mode, a user can perform maintenance such as operation status check on the Web UI screen, setup initialization, and firmware update.

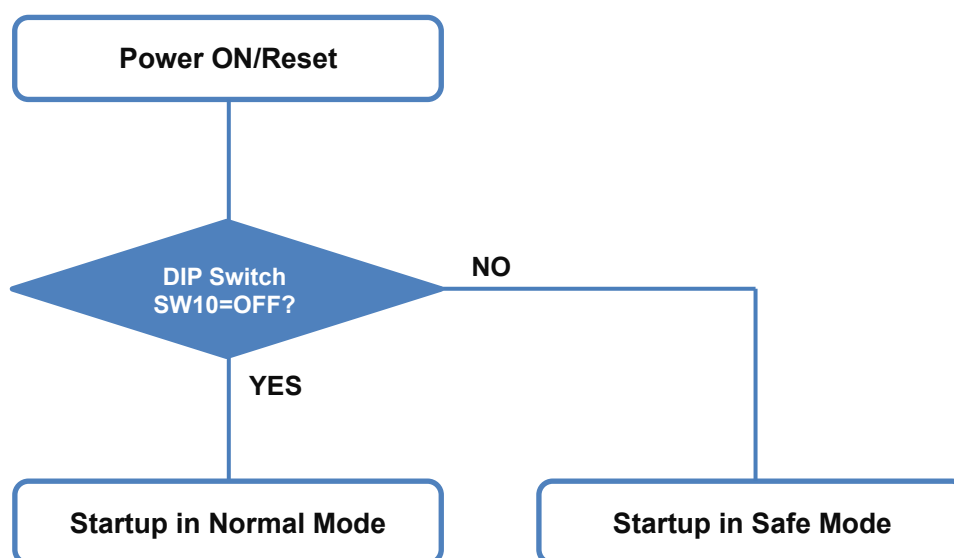

3.2. Setup Status and Collecting Status

Under the normal mode, there are a "setup status" to configure settings and a "collecting status" to collect and save measured data. Statuses transition as shown below:

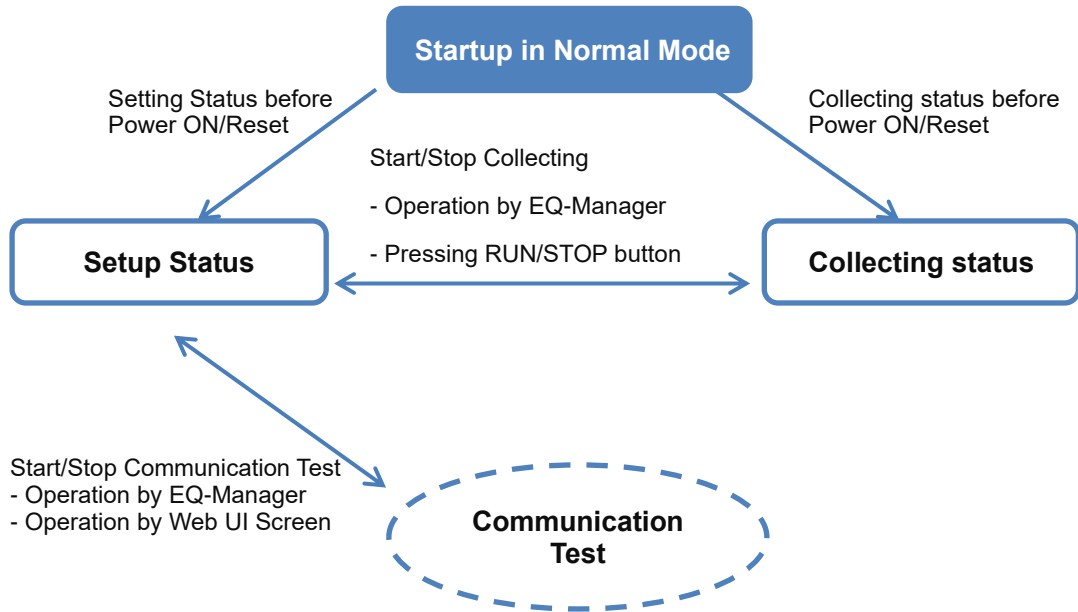

Reference

- The communication test checks stable data collecting by EQ100 from measurement devices. Before starting measured data collecting, always perform the communication test.
- The operation status can be checked by collecting status indicator on the EQ100 front end.
- The product is shipped with the setup status.
- If the power is turned off or blackout occurred under the collecting status, the system is activated under the collecting status when the power is turned on again.
- When a status transitions from collecting to setup, unsaved collected data are saved in the EQ100 internal memory.
- When a status transitions from collecting to setup, all of the device alarms being occurred are cleared.

■ Status Change after Power On or Reset

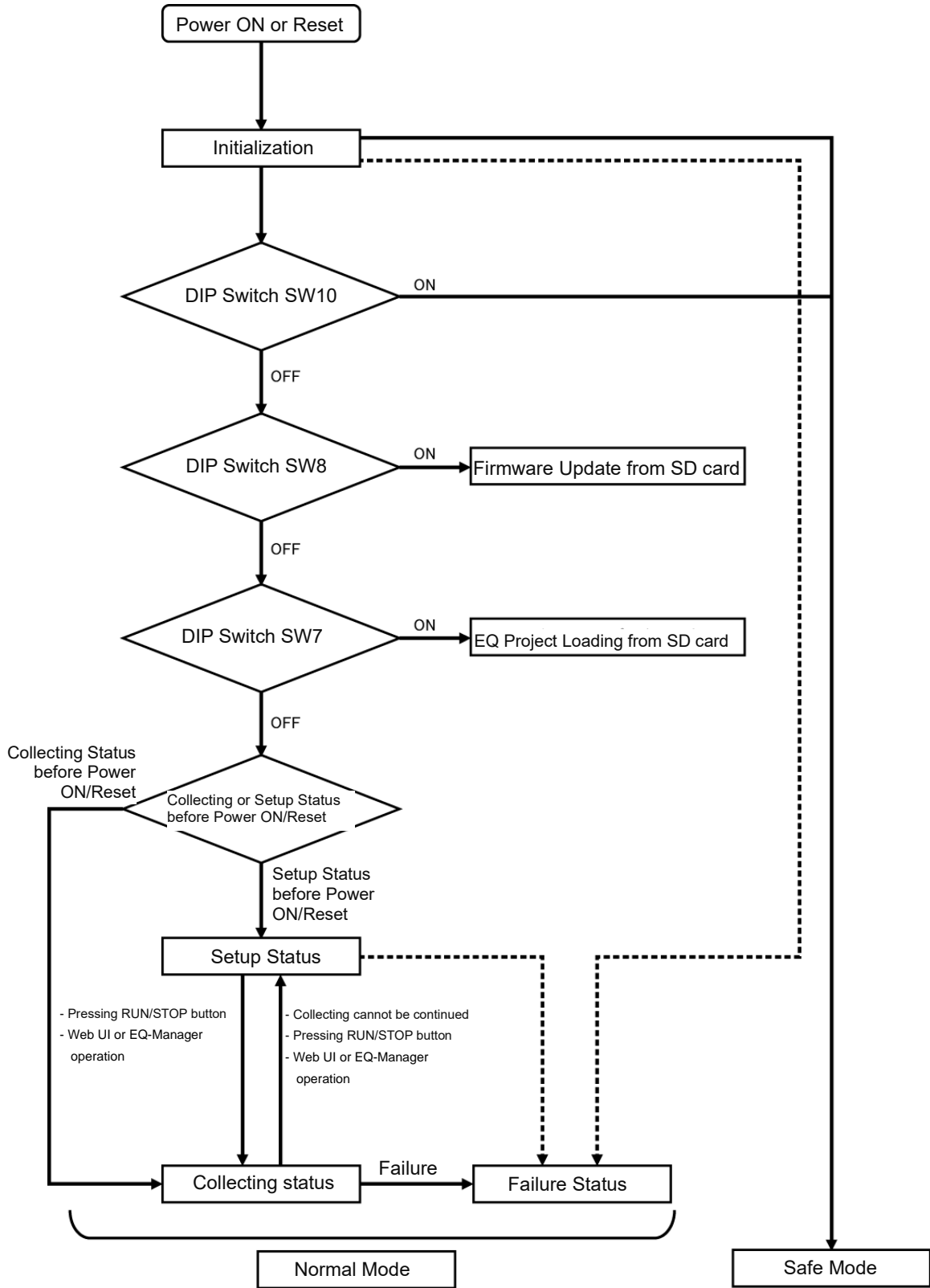

3.3. Specifications of Operation Mode and Status

Operation Mode/Status		Definition	Transition to Other Status
Startup Process		The system is under startup processing in normal mode or safe mode after turning on the power or reset (pressing the button or Web UI operation).	When an instrument failure occurs, the status transitions to "system error status". For other cases, see below: <ul style="list-style-type: none"> - If the setup DIP switch SW10=OFF, the status transitions to one right before turning on the power or reset. - If the setup DIP switch SW10=ON, the status transitions to "safe mode".
Normal Mode	Setup Status	A status in which setup by EQ-Manager is available. If the system is started up under normal mode, the status becomes the setup status.	<ul style="list-style-type: none"> - The status transitions to "communication testing status" by Web UI operation or by the operation of EQ-Manager. - The status transitions to "preparing for collecting" then "collecting status" by pressing the RUN/STOP button(*), Web UI screen, or EQ-Manager operations. - When an instrument failure or a setup/status failure occurs, the status transitions to "system error status".
	Communication Test	Only data collecting from measurement devices is continuously performed.	<ul style="list-style-type: none"> - The status transitions to "setup status" by Web UI or EQ-Manager operation. - When an instrument failure or a setup/status failure occurs, the status transitions to "system error status".
	Collecting status	A status in which measured data are collected from a measurement device and logged (in the internal memory). Collecting is continued even after an occurrence of a communications error or monitoring process error.	<ul style="list-style-type: none"> - The status transitions to "setup status" by pressing and holding the RUN/STOP button(*), or Web UI or EQ-Manager operation. - When an instrument failure or a setup/status failure occurs, the status transitions to "system error status".
	System Error Status	A status in which an instrument failure of the EQ100 occurred.	No transition occurs to other statuses.
Safe Mode		A status in which the system cannot be properly started up due to a hardware failure or a firmware update failure. Or a status transitioned from other status after turning on the power with the setup DIP switch SW10=ON or reset (pressing the button or Web UI operation). In this mode, operations of setup initialization and firmware update is available from the Web UI screen.	It does not transition to normal mode.

*: If the setup DIP switch SW9=OFF, the RUN/STOP button can be operated. If SW9=ON, the RUN/STOP button is disabled.

4. Basic Operation Steps

This chapter describes basic operation steps of EQ100. For detail setup and operations, see reference for each step.

4.1. [STEP 1] Standalone Configuration

Described below are basic operation steps for a standalone configuration operated by the Web UI function only.

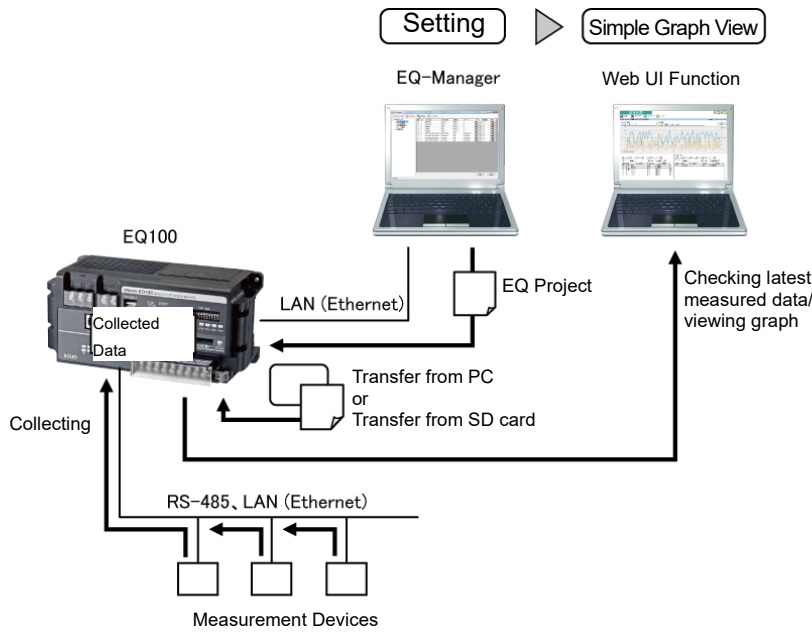

[Step 1] Measurement Device Setting (including Communications Setting)/Measurement Setting

Operate the measurement device itself or use the setup software for the measurement device to configure the device main setting (including communications setting) and measurement setting.

Precautions for Correct Use

- EQ-Manager cannot configure measurement device setting (including communications setting)/measurement setting. Operate the measurement device itself or use the setup tool for the measurement device to configure the required settings.

Refer to

"6. Measurement Device Setup and Connection", "Measurement Device Manuals"



[Step 2] Connecting Memory Backup Battery

Connect a memory backup lithium battery to EQ100, and remove the caution label attached on the top of the EQ100.

Precautions for Correct Use

- If EQ100 power is turned off without connecting a memory backup battery, proper data collecting may not be available due to loss of collected data of the latest 1 hour and/or reset of the built-in clock. Always connect a battery.

Refer to

"5. Installation and Wiring"



[Step 3] EQ100 Time Setting by Web UI Operation					
Configure the time for the built-in clock of EQ100 by Web UI operation. 1) Configure the computer's IP address as "192.168.200.***"(*** is a value different from EQ100's IP address) and the subnet mask as "255.255.255.0". 2) Connect a LAN cable between the computer and the LAN connection port of EQ100. 3) On the Web UI screen, select [Maintenance] - [System] - [Clock Setting], enter the time to set and click [Execute].					
<table border="1"> <thead> <tr> <th colspan="2">Reference</th> </tr> </thead> <tbody> <tr> <td colspan="2">- To adjust the built-in clock of EQ100 to a LAN-connected external SNTP server or EQ server, use EQ-Manager to select [Advanced Setting] - [System Setting] - [Time Synchronization Setting], change "Method" from "None"(initial value) to "SNTP server" or "EQ server", and write an EQ project.</td> </tr> </tbody> </table>		Reference		- To adjust the built-in clock of EQ100 to a LAN-connected external SNTP server or EQ server, use EQ-Manager to select [Advanced Setting] - [System Setting] - [Time Synchronization Setting], change "Method" from "None"(initial value) to "SNTP server" or "EQ server", and write an EQ project.	
Reference					
- To adjust the built-in clock of EQ100 to a LAN-connected external SNTP server or EQ server, use EQ-Manager to select [Advanced Setting] - [System Setting] - [Time Synchronization Setting], change "Method" from "None"(initial value) to "SNTP server" or "EQ server", and write an EQ project.					
Refer to	"9. Web UI Function"				



[Step 4] Installation					
Install measurement devices and EQ100. 1) Installing Measurement Devices 2) Installing EQ100					
<table border="1"> <thead> <tr> <th colspan="2">Reference</th> </tr> </thead> <tbody> <tr> <td colspan="2">- It is recommended that EQ100 should be configured before installation in [Step 7] described later. Configuring the settings beforehand can make checking tasks easier and reduce redo man-hours if there are any limitations on the installation task (e.g. dark place, high place, electric shock hazard, and schedule).</td> </tr> </tbody> </table>		Reference		- It is recommended that EQ100 should be configured before installation in [Step 7] described later. Configuring the settings beforehand can make checking tasks easier and reduce redo man-hours if there are any limitations on the installation task (e.g. dark place, high place, electric shock hazard, and schedule).	
Reference					
- It is recommended that EQ100 should be configured before installation in [Step 7] described later. Configuring the settings beforehand can make checking tasks easier and reduce redo man-hours if there are any limitations on the installation task (e.g. dark place, high place, electric shock hazard, and schedule).					
Refer to	"5. Installation and Wiring", "6. Measurement Device Setup and Connection", "Measurement Device Manuals"				



[Step 5] Hard Wiring	
Connect the power, LAN port, RS-485 communications ports, general-purpose input, and general-purpose outputs.	
Refer to	"5. Installation and Wiring"



[Step 6] Preparing Setup	
Install EQ-Viewer to a computer for setup to prepare EQ100 settings. 1) Install EQ-Viewer to a computer for setup 2) Start up EQ-Manager	
Refer to	"EQ-Viewer User's Manual"



[Step 7] Creating/Configuring EQ Project	
For EQ100 settings, use EQ-Manager to create an EQ project. Follow the steps described below:	
1) Create a new EQ project 2) Register a measurement device (To use the general-purpose input, register pulses as a device and configure an operation channel) 3) Register a channel	

4) Register a channel group if necessary 5) Configure EQ100 settings 6) Configure monitoring settings if necessary 7) Configure settings for collected data file/event log file output if necessary 8) Save the EQ project	
Refer to	"7. EQ100 Settings", "EQ-Viewer User's Manual"



[Step 8] Writing EQ Project	
<p>●Writing through SD Card</p> <ol style="list-style-type: none"> 1) Save an EQ project on an SD card 2) Insert the SD card to EQ100 (Do not write protect the SD card) 3) Configure the setup DIP switch SW7 of EQ100 as ON 4) Turn on the power again 5) Check the completion of EQ project write 6) Configure the setup DIP switch SW7 of EQ100 as OFF 7) Turn on the power again <p>Reference</p> <ul style="list-style-type: none"> - Reset can be done by clicking [Maintenance] menu - [System] - [Main Body Operation] and selecting [Restart] on the Web UI screen. 	<p>●Writing through LAN from EQ-Manager</p> <ol style="list-style-type: none"> 1) Connect a computer for setup to EQ100 via LAN 2) Connect online from EQ-Manager to EQ100 3) Write an EQ project from EQ-Manager to EQ100
Refer to	"7. EQ100 Settings", "EQ-Viewer User's Manual"



[Step 9] Communication Test between EQ100 and Measurement Device	
Perform communication test between EQ100 and measurement devices using either of the following operations: - In the EQ-Manager [Logger] menu, select [Online] - [Start Test] - On the Web UI screen, click [Operation] - [Communication Test]	
Refer to	"8. Communication Test and Collecting Start", "9. Web UI Function", "EQ-Viewer User's Manual"



[Step 10] Starting Data collecting from Measurement Device to EQ100	
Start data collecting from a measurement device to EQ100 using either of the following operations: - Press the RUN/STOP button on the EQ100 front end - In the EQ-Manager [Logger] menu, click [Start Logging] - On the Web UI screen, click [Operation] - [Collecting]	
<p>Reference</p> <ul style="list-style-type: none"> - The collecting status is indicated by the following indicator of the EQ100 front end: Collecting status Indicator: On 	
Refer to	"8. Communication Test and Collecting Start", "EQ-Viewer User's Manual"



[Step 11] Checking EQ100 Status on Web UI Screen

A graph or current value of data collected by EQ100 can be viewed using the following operations:

- | |
|--|
| <ul style="list-style-type: none">- On the Web UI screen, select [Current Value Monitor]- On the Web UI screen, select [Graph View] |
|--|

Refer to	"9. Web UI Function"
-----------------	----------------------

Reference

- It is recommended that collected data should be saved on an SD card every day on a specified hour even if the collected data are referred to by the Web UI function only.

4.2. [STEP 2] Network Configuration with EQ Server

In case of a network configuration using an EQ server, the following steps are required in addition to the [STEP 1].

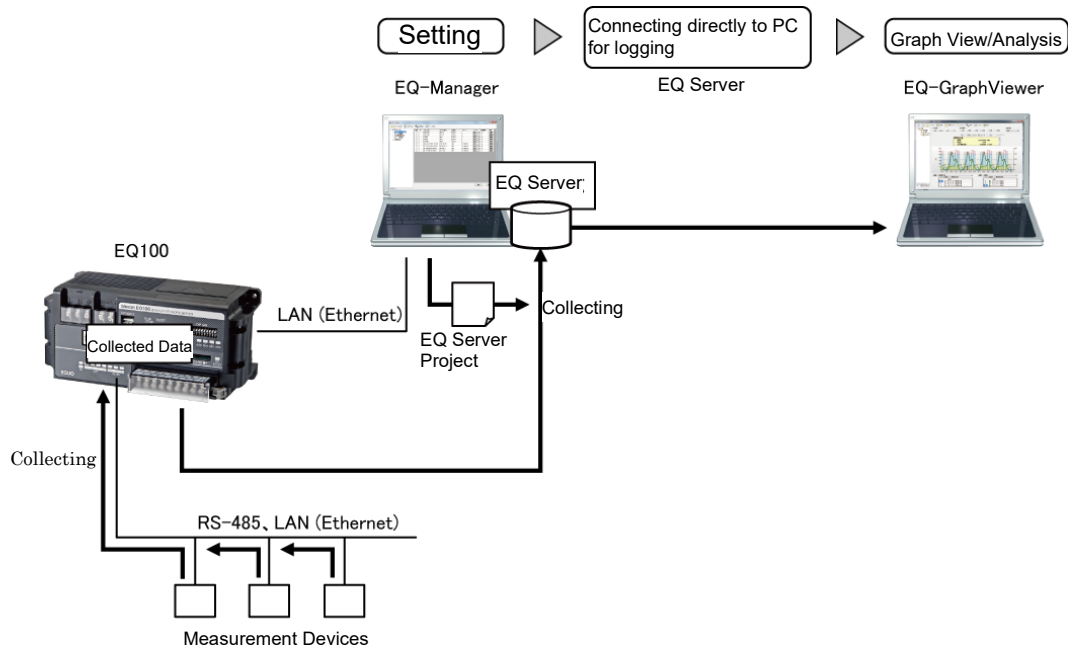

Reference

- To connect EQ100 to an existing LAN, ask the network administrator for available IP addresses and other settings.

[Step 1] Creating/Configuring EQ Server Project

To collect data online from EQ100 using an EQ server, EQ-Manager is required to create an EQ server project.

Follow the steps described below to create an EQ server project:

- 1) Create a new EQ server project
- 2) Register a collecting device
Register one or more EQ100 for collecting by the EQ server.
- 3) Register a channel
Reuse registered data of an EQ project to register a channel for the EQ server project.
Select a channel as a collecting target for the EQ server to read.
- 4) Register a group if necessary
Register it if you need to view/summarize collected data on a group basis such as an area.
Group registration is required for graph view by EQ-GraphViewer.
- 5) Configure advanced settings if necessary
Configure control value, data type, and system settings if necessary.
- 6) Save the EQ server project

Refer to "EQ-Viewer User's Manual"



[Step 2] Writing EQ Server Project	
1) If EQ-Manager and EQ-ServerService are not on the same computer, connect a computer for setup and the EQ server (a computer with EQ-ServerService installed) via LAN. 2) Connect online from EQ-Manager to the EQ server: In the [Logger] menu, select [Online] 3) Write the EQ server project from EQ-Manager to EQ server: In the [Logger] menu, select [Write Settings]	
Refer to	"7. EQ100 Settings", "EQ-Viewer User's Manual"



[Step 3] Communication Test between EQ Server and EQ100	
1) Connect a computer (EQ server) to EQ100 via LAN. 2) Perform communication test between the EQ server and EQ100 using the following operation: In the EQ-Manager [Logger] menu, select [Online] - [Start Test]	
Refer to	"8. Communication Test and Collecting Start", "EQ-Viewer User's Manual"



[Step 4] Starting Collecting from EQ100 to EQ Server	
Start data collecting from EQ100 to the EQ server using the following operation: - Use EQ-Manager to open the EQ server project, and in the [Logger] menu select [Online] - [Start Logging]	
Refer to	"EQ-Viewer User's Manual"



[Step 5] Viewing/Analyzing Graph on EQ-GraphViewer	
(1) Start up EQ-GraphViewer (2) Connect EQ-GraphViewer to the EQ server In the [Connect Server] dialog box, specify the EQ server (3) Select a channel group to view a graph (4) Configure settings such as a graph type, view duration, and summary interval based on the purpose	
Refer to	"EQ-Viewer User's Manual"

4.3. [Reference] Taking Out Collected Data Using SD Card

Data files collected by EQ100 can be taken out using an SD card. Described below are basic steps to take out and handle collected data using an SD card.

● Viewing/Analyzing Graph with Commercial Software such as Excel

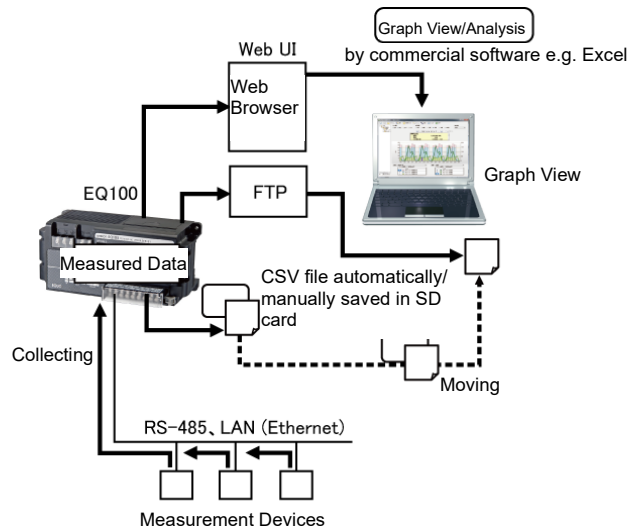

● Viewing/Analyzing Graph with EQ-Viewer

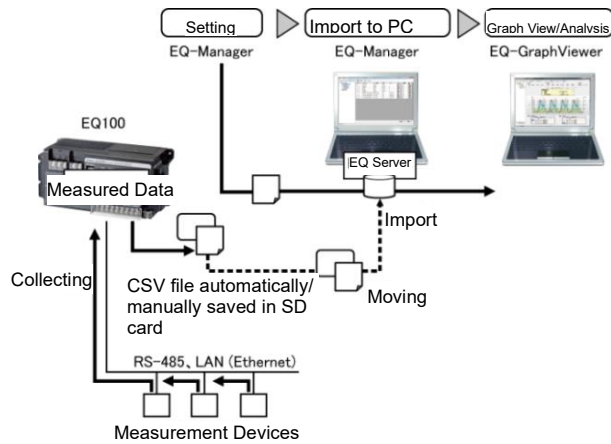

【Step1】 Perform [Step 1] adding to the setting to be performed in the standalone configuration.

[Step 1] Configuring Conditions to Save on SD Card	
To automatically output collected data files from the EQ100 internal memory to an SD card, follow the steps below: - Use EQ-Manager to select [Advanced Setting] - [SD Card Output Setting]	
Refer to	"8. Communication Test and Collecting Start", "EQ-Viewer User's Manual"



[Step 2] Outputting Collected Data Files to SD Card		
<ul style="list-style-type: none"> - For autosave: Once a day, at a specified hour - For manual save: Press the SD card save button for 1 second on the EQ100 front end, or on the Web UI screen select [Maintenance] - [System] - [SD Card Data Output] 		
<table border="1" style="margin: auto;"> <tr> <td style="padding: 5px;">Reference</td> </tr> </table>		Reference
Reference		
<ul style="list-style-type: none"> - The following indicator of the EQ100 front end indicates that the collected data are being written on the SD card: SD Card Access Indicator: On while writing 		

Refer to	"7. EQ100 Settings", "EQ-Viewer User's Manual"
-----------------	--



[Step 3] Viewing/Analyzing Graph on Commercial Software e.g. Excel or EQ-GraphViewer	
<ul style="list-style-type: none"> ● Viewing/Analyzing Graph with Excel or Other Software 1) Eject the SD card from EQ100 and attach it to a computer 2) Use commercial software such as Excel to open the collected data files on the SD card 	<ul style="list-style-type: none"> ● Viewing/Analyzing Graph with EQ-GraphViewer 1) Eject the SD card from EQ100 and attach it to a computer 2) Open the EQ server project and connect online to the EQ server 3) Select [Advanced Setting] - [Maintenance] - [CSV Import] Select and import a CSV file and channel to read from the collected data files on the SD card 4) Use EQ-GraphViewer to view the graph
Refer to	"10. Viewing/Analyzing Graph on EQ-GraphViewer", "EQ-Viewer User's Manual"

5. Installation and Wiring

5.1. Precautions on Installation

Installation must take into the following items into account for higher authenticity and performance of EQ100.

■ Installation Location

For installation, avoid the locations:

- subject to large vibration or shock impact
- subject to direct sunlight, wind, or rain, or outdoors
- where temperature or humidity is out of the specified range
- subject to large changes of temperature or humidity, or potential dew condensation or freezing
- subject to static electricity or noise
- subject to corrosive gases (especially sulfide or ammonia gas)
- subject to heavy dust or iron powder
- subject to water splashing or oil contact
- subject to salt water splashing

■ Mounting

For main body heat radiation, only the following installation is allowed.



Do not install in a way as shown below.

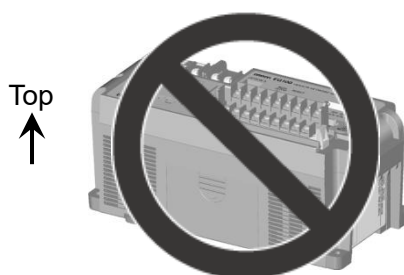

- Do not block the ventilations holes and the peripheral areas. It may obstruct heat radiation.
- For heat radiation, keep spaces of 30mm or more for the top and bottom of this product.
- Do not place the product close to heat radiating equipment (e.g. heater, transformer, high-capacity resistor).

5.2. Battery Connection

This product has a battery for memory backup to keep collected data upon blackout.

Precautions for Correct Use

- The memory backup battery is a consumable item. When the battery's remaining capacity becomes low, the device alarm indicator on the product's front end turns on and the battery must be replaced to new one.

Precautions

- Before installing the EQ100, always attach the memory back up battery. Otherwise proper data collecting may not be available upon blackout or power off, due to reset of the built-in clock, loss of totalized information, and/or loss of collected data of the latest 1 hour.

The battery is attached inside the EQ100 top cover, while the battery connector is not attached upon factory shipment. Before using the product, attach the battery connector using the following steps.

- 1) Remove the top cover.

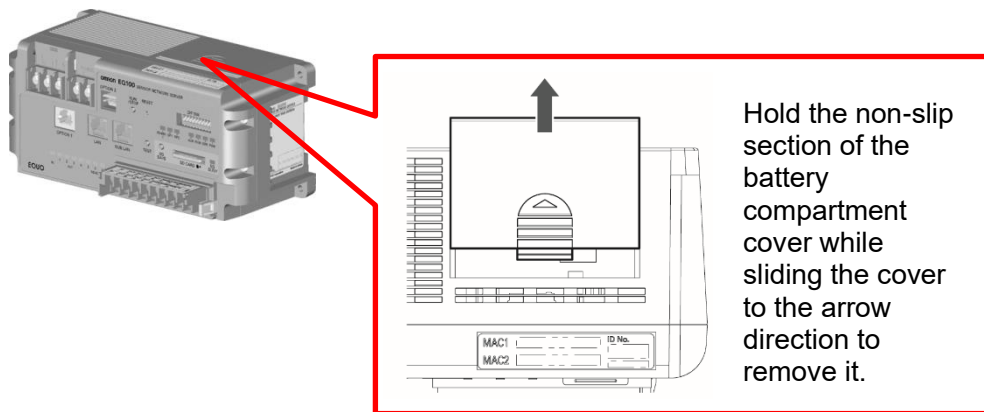

- 2) Attach the battery to the connector and place it inside the EQ100.

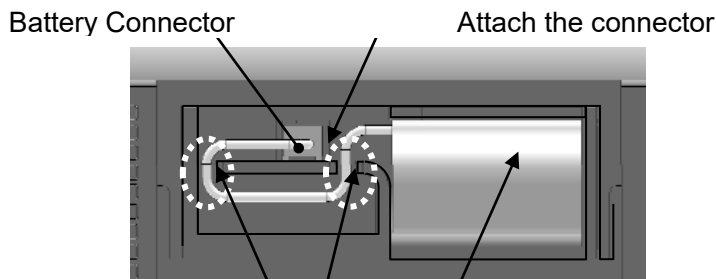

The battery and the cable must be placed in the position shown in the figure.

- 3) Close the cover.

- 4) Remove the caution label for the memory backup battery attached on the top of the EQ100.

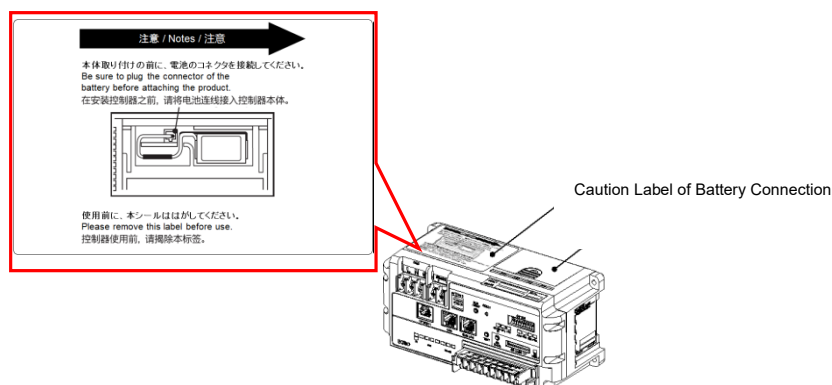

Precautions for Correct Use

- Before using the product, always remove the caution label for the memory backup battery attached on the top of the EQ100.
- * Battery Life
 - The battery life is around 5 years (at ambient temperature of 23°C), largely depending on the operating conditions. This life value is only a reference one and is not guaranteed.
 - When a low battery is detected, the device alarm indicator on the EQ100 front end flashes. Replace the battery within two weeks from the low battery detection.
 - Turn off the power before replacing the battery. Attach a new battery within five minutes from turning off the power. Otherwise the stored data may become indefinite.
- * Purchase of New Battery
 - For purchase of a new memory backup battery, contact our sales representative.

Product Name	: Memory backup battery
Model	: CP1W-BAT01
Product Code	: CP1W-0101E

Precautions for Correct Use

- After mounting on a DIN rail or attaching with screws, the EQ100 top cover cannot be opened. Always attach the battery before mounting.

Precautions

- If you do not use the product for a long period of time, remove the battery. This should prevent battery consumption and a failure due to leak.



WARNING



A lithium battery is used for memory backup. Do not disassemble, apply pressure to deformation, overheat to more than 100°C, and/or burn it. Otherwise serious injury may occasionally occur due to fire and/or explosion.

5.3. Mounting Inside the Cabinet

Typically the product is mounted to the cabinet using a DIN rail.

Before mounting the product on a DIN rail, always attach the memory backup battery. For attaching, refer to the steps described in "5.2. Battery Connection".

Use the following steps to mount the product to a DIN rail.

- 1) Unlock the DIN rail mounting pins on the back of the EQ100 (see below, (1)).
- 2) Hook the product from the top side of the DIN rail (see below, (2)).

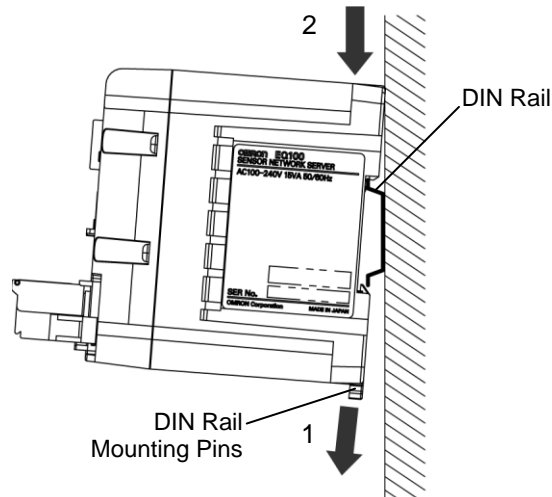

- 3) Press in the product to mount (see below, (3)).
- 4) Lock the entire DIN rail mounting pins (see below, (4)).

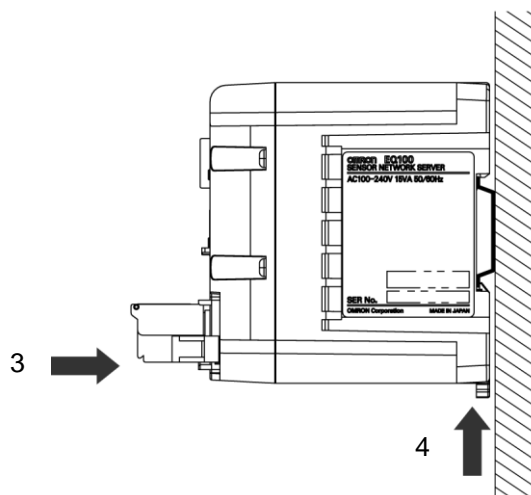

Precautions

- Use three or more screws to mount the DIN rail.

Reference

- Recommended DIN rail: PFP-50N (500mm)/PFP-100N (1000mm)

5.4. Screw-Mounting

To mount the product using screws, make mounting holes with the following sizes, attach the specified screws, and apply the appropriate tightening torque to mount the product.

- Screw to Use : M4
- Specified Torque : 1.2 N · m

This product does not include the mounting screws. The screws must be acquired by the user. Depending on the mounting conditions such as material and thickness of the place to mount, screw type and length may differ. Use proper screws based on the mounting conditions.

Before mounting the product, always attach the memory backup battery. For attaching, refer to the steps described in "5.2. Battery Connection".

■ Mounting Hole Dimensions

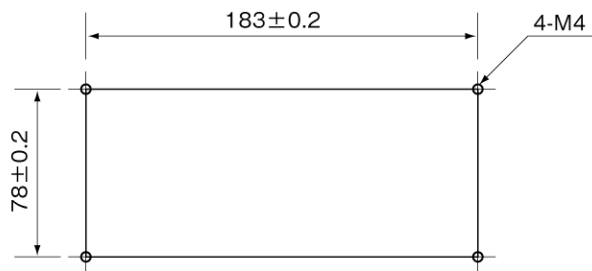
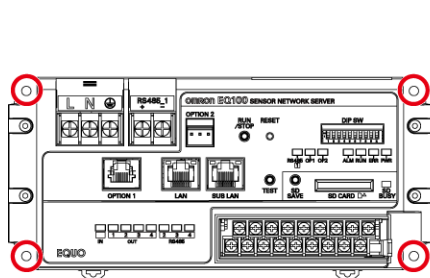

(Unit: : mm)

5.5. Wiring Description

5.5.1. Power and Grounding Wires

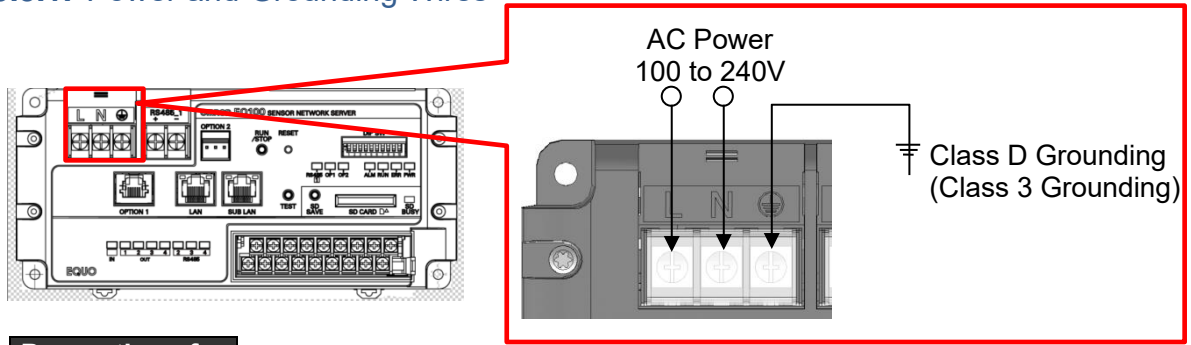

Precautions for Correct Use

- Connect the power to the power terminals (L-terminal, N-terminal). Be sure to connect to the correct terminal board.

■ AC Power

100 to 240 VAC power source must be supplied.

If one phase of the power source is grounded, the grounded phase must be connected to the N terminal.

The power source must be within the following allowable power supply voltage range.

Supply Voltage	Allowable Power Supply Voltage Range
100 to 240 VAC	85 to 264 VAC

■ Grounding Wire

The grounding terminal must be class-D earthed (class-3 earthed in the older standards in Japan).

■ Terminal Screw and Crimping Terminal

Terminal Screw	M3.5 captive screw
Recommended Tightening Torque	0.8 N·m

Recommended Crimping Terminal

(Unit: mm)

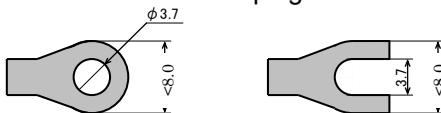

Precautions

- Use proper crimping terminals to the terminal block for wiring.
- Keep a little room upon wiring of power and grounding terminals. It should make easier the dismounting task of EQ100 for battery replacement.

CAUTION

Electric shock may occur.
Before wiring on the terminal block and/or battery replacement, turn off the power.

Otherwise the product may be damaged and/or disrupted.
The supply voltage must be within the specified range.

5.5.2. RS-485 Communication Port

■ RS-485 Communications Port Wiring

This product has four RS-485 communications ports for RS-485-connected measurement devices. Up to 31 devices can be connected to one port.

Maximum transmission distance is 500 m for RS-485 communications.

For an RS-485 communications port cable, a shielded twisted-pair cable of AWG24 to14 (0.205 to 2.081 mm²) or higher must be used. To prevent malfunction, a shielded wire for the RS-485 communications cable must be connected to the ground or FG terminal.

This product has a built-in terminal resistor on each RS-485 communications port terminal. The RS-485 cables must be wired so that this product should be on one end of the terminal. For a device that is connected to the terminal end opposite to this product, a terminal resistor of 120 Ω (1/2 W) must be attached.

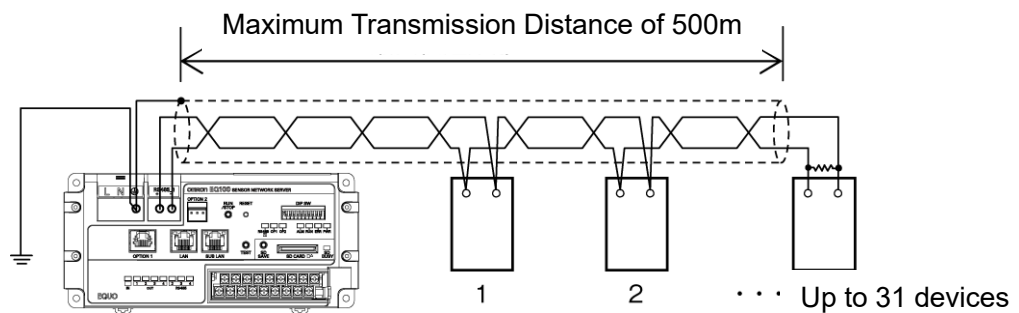

Precautions for Correct Use

- The RS-485 cables must be wired through measurement devices in one loop. Branching and/or star wiring is not available.

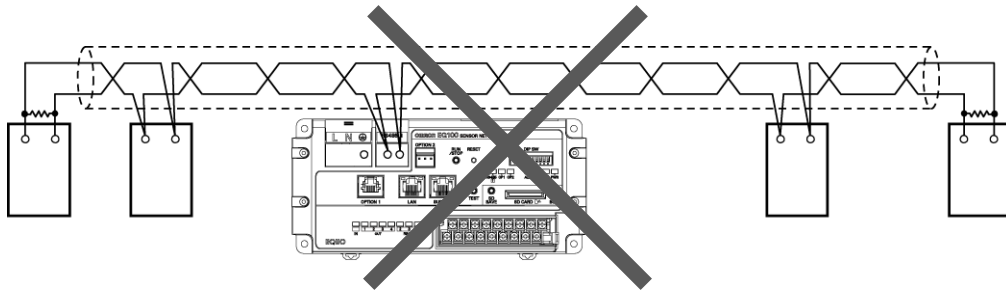

Precautions

- Keep a little room upon wiring of RS-485 communications port terminal and a communications cable.
- It should make easier the dismounting task of EQ100 for battery replacement.

■ Terminal Screw and Crimping Terminal

RS-485 Communications Port #1

Terminal Screw	M3.5 captive screw
Recommended Wire Size	AWG24 to 14 (0.205 to 2.081 mm ²)
Recommended Tightening Torque	0.8 N·m

Recommended Crimping Terminal

(Unit: mm)

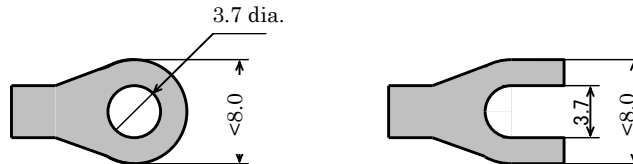

RS-485 Communications Ports #2 to 4

Terminal Screw	M3 captive screw
Recommended Wire Size	AWG24 to 14(0.205 to 2.081mm ²)
Recommended Tightening Torque	0.5 N·m

Recommended Crimping Terminal

(Unit: mm)

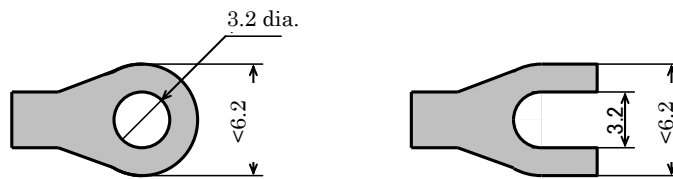

Precautions

- Note that the terminal screw sizes differ between the RS-485 communications port #1 and the ports #2 to 4.
- Make sure to apply torque of 0.8 N·m to the terminal screws of the RS-485 communications port #1.
- Make sure to apply torque of 0.5 N·m to the terminal screws of the RS-485 communications ports #2 to 4.
- Use proper crimping terminals to the terminal block for wiring.

5.5.3. General-Purpose Output Terminal

■ Checking Input/Output Specifications

Check the input/output specifications of the general-purpose input/output terminals. Applying a voltage over the rated one to the input terminal, or a voltage over the maximum load voltage to an output terminal, may result in a failure, disruption, or fire.

Be careful not to connect positive and negative terminals oppositely, if specified.

■ Terminal Screw and Crimping Terminal

Terminal Screw	M3 captive screw
Recommended Wire Size	AWG22 to 18 (0.326 to 0.823 mm ²)
Recommended Tightening Torque	0.5 N·m

Recommended Crimping Terminal

(Unit: mm)

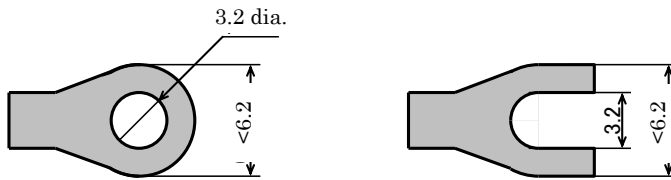

Precautions

- Use proper crimping terminals to the terminal block for wiring.
- Make sure to apply torque of 0.5 N·m to the terminal screws.

■ Input/Output Devices

For selection and connection of devices to the general-purpose input/output terminals, refer to the followings:

● Example of Input Device and EQ100 Internal Circuit

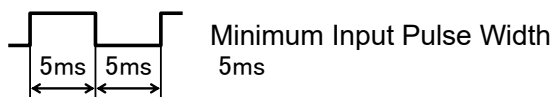
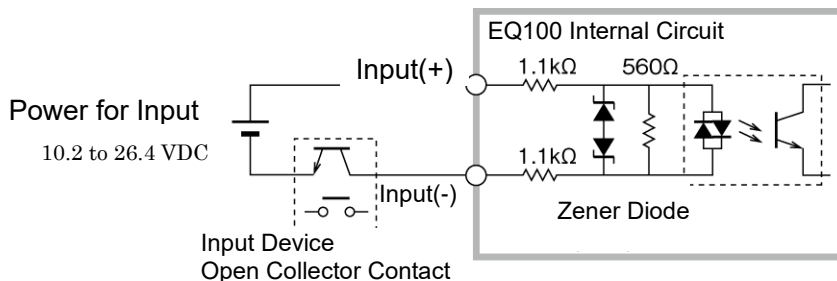

● Example of Output Device and EQ100 Internal Circuit

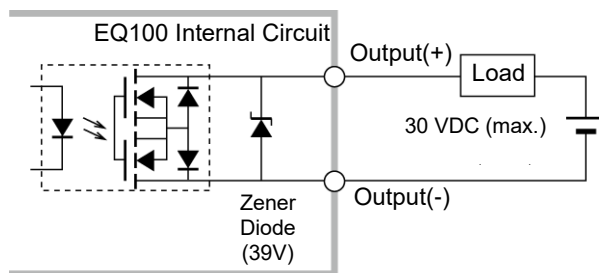

5.5.4. LAN Connection Port

To connect EQ100 to a computer, connect a LAN cable to the following LAN connection port.

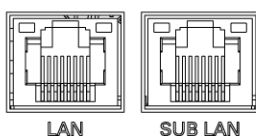

Precautions for Correct Use

- To the sub-LAN port of EQ100, an upper level system cannot be connected, such as the EQ server, SMTP server, Sntp server, and FTP server.
- If you wish to perform maintenance of a sensor that is connected to the sub-LAN port of EQ100 using the software attached to the sensor, use a computer connected to the network on the sub-LAN.

Precautions

- Keep a little room upon wiring of a LAN cable to the LAN port.
- It should make easier the dismounting task of EQ100 for battery replacement.

5.5.5. SD Card

■ SD Card Available on EQ100

Card Form Factor	Full size (an adapter must be used for miniSD and microSD)
File System	FAT 16 for SD card, FAT32 for SDHC card
Speed Class	Class 2 or higher (SDHC card)



Precautions

- The recommended SD card is OMRON's HMC-SD491 (4GB), HMC-SD291 (2GB).
- If you are using a third-party card, SD card for industrial use is recommended.

Reference

- SD Card Available on EQ100

Yes: Available, N/A: Not available

Standards	SD	SDHC	SDXC
Mark			
Maximum Capacity	2 GB	32 GB	2 TB
File System	FAT16	FAT32	exFAT
Use on EQ100	Yes	Yes	N/A

- Use the formatting software to format an SD/SDHC card.
- For the SD card formatting software distribution site, refer to the following URL.
<https://www.sdcard.org/jp/downloads/>

■ Inserting an SD Card

- ① Make sure the proper direction of the SD card (the notch of the SD card must be on the right back).
- ② Slowly insert the SD card to the SD card slot until you hear a click sound, then release the card.

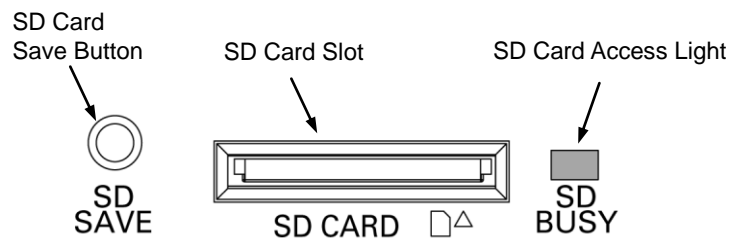

■Ejecting an SD Card

To eject an SD card from the SD card slot, always use the following steps.

- (1) Press and hold the SD card save button for 5 seconds or longer.
- (2) After the buzzer sound stopped and the SD card access indicator turned off, release the SD card save button.
- (3) Insert the SD card in the back until you hear a click sound, then release the card.
- (4) Pick an end of the SD card and draw it out from the SD card slot.

Precautions

- Before inserting/ejecting an SD card, discharge static electricity by touching a grounded metal object, etc.

■Dummy SD Card

A dummy SD card is attached to the SD card slot upon factory shipment.

To use an SD card, remove the dummy SD card before.

If you do not use any SD card, keep the dummy SD card in the SD card slot to protect the slot.

Reference

- Upon the 1st SD card output after EQ100 setup, all data stored before then are outputted. If the amount of data that are not saved for a long time exist, output will take a long time to finish.
- A restarting operation through Web UI or the reset button automatically unmounts the SD card, turns off the SD BUSY LED indicator, and restarts the product.

6. Measurement Device Setup and Connection

6.1. Measurement Device Main Body Setup and Measurement Setup

Before connecting a measurement device to EQ100, main body setting including communications setting and measurement setting must be configured for each measurement device.

Operations may differ for each measurement device type. Refer to user's manual or instruction manual of each measurement device for configuration.

Precautions for Correct Use

- Some measurement devices need a computer to configure the main body setting with dedicated software.
 - > KM1/KE1 series, WZ series
- Some measurement devices need EQ100 or a computer to check measured values due to a lack of display function.
 - > KM20-B40-FLK, KM1/KE1 series, WZ series

Reference

- Configuring measurement devices beforehand can make checking tasks easier and reduce redo man-hours if there are any limitations on the installation task (e.g. dark place, high place, electric shock hazard, and schedule).

6.1.1. Preparation

The description below is for reference of measurement device preparation to connect to EQ100. Actual system construction must be planned, designed, and performed by the customer.

■ Preparation

● Measurement Device

Yes: Required, No: Not required

Device Type		Method		
Name	Model	Main Body Setting Function (*3)	Setup Software	
			Name	Connection to PC
Smart Power Monitor	KM-N1-FLK	Yes		
Power Monitor	KM-N2-FLK	Yes		
Power Monitor	KM-N3-FLK	Yes		
Smart Power Monitor	KM20-B40-FLK	Yes	EasyKM-Manager	Converter (*1)
Smart Power Monitor	KM100-T□-FLK	Yes	EasyKM-Manager	
Smart Power Monitor	KM50-□-FLK	Yes	EasyKM-Manager	
Power Measurement Unit	KM1-PMU1A-FLK	No	KM1/KE1 Setting	USB Converter (*1)
Dual Power System Measurement Unit	KM1-PMU2A-FLK	No	KM1/KE1 Setting	
Pulse/Temperature Input Unit	KM1-EMU8A-FLK	No	KM1/KE1 Setting	
CT Expansion Unit	KE1-CTD8E	No	KM1/KE1 Setting	
1/32 DIN Digital Panel Meter	K3GN-□□□-FLK	Yes		
Digital Panel Meter	K3HB-□□□-FLK3	Yes		
Digital Temperature Controller	E5□C	Yes	CX-Thermo	Converter (*2)
Air Particle Sensor	ZN-PD□□-S	Yes		
Air Thermo Station	ZN-THX21-S□	Yes	Station Utility	LAN
Portable Power Monitor	ZN-CTX21	Yes	Station Utility	
Power Sensor Station	ZN-KMX21	Yes	Station Utility	
Differential Pressure Station	ZN-DPX21-S□	Yes	Station Utility	
Air Flow Station	D6FZ-FGX21	Yes	Multi Data Viewer Light	LAN
Wireless Unit Master	WZ-MLAN01	No	WZ Manager	USB
Wireless Unit Slave (CompoWay/F)	WZ-SRS01	No	WZ Manager	
Wireless Device Thermo-Humidity Sensor	WZ-STH01	No	WZ Manager	
Wireless Device Light Intensity Sensor	WZ-SL01	No	WZ Manager	
Wireless Device Thermo-Humidity Light Intensity Sensor	WZ-STHL01	No	WZ Manager	
Wireless Device CO ₂ Sensor	WZ-SCD01	No	WZ Manager	
Wireless Unit Slave (Pulse Count)	WZ-SP01	No	WZ Manager	
Programmable Controller	CJ Series	No	CX-Programmer	LAN
	NJ Series NX1P Series	No	Sysmac Studio	LAN
Modbus RTU Device	-	-	-	-

*1: USB, RS-232C/RS-485 converter (K3SC), LAN/RS-485 converter

*2: USB, RS-232C/RS-485 converter (K3SC), USB-serial conversion cable (E58-CIFQ2)

*3: Device that can be directly configured by measurement device operation

●Wire & Connection Device

Power cable (100 VAC), RS-485 communications port cable, LAN cable, switching hub
USB cable (for KM1/KE1, A-miniB)
USB cable (for WZ series, accessory of WZ-MLAN01)

●Computer for Setup Software

Install the setup software for each measurement device.

●Documentation of Measurement Devices

User's Manual/Communications Manual for Measurement Devices

- The operation manual attached to a measurement device may not include necessary information. Always refer to user's manual.
- For KM100 or KM20, see general catalog for energy-saving support devices (SGTE-616□).
- Refer to memory map on communications manual. It will help understanding of measurement channels.

6.1.2. Measurement Device Setup

This setup is required for a measurement device to connect to EQ100 and collect measured data. As a result, measurement devices must be separately identified and configured. For details of measurement device settings, see respective user's manual.

■RS-485-Connected Measurement Device Settings

Select communications protocol and configure the unit number and communications conditions.

Before doing so, define combinations of RS-485-connection measurement devices and four RS-485 communications ports of EQ100. Configuration must be made so that the following conditions for the RS-485 measurement devices to connect should be met for each RS-485 communications port.

- Communications settings (communications protocol, communication speed, data length, stop bits, vertical parity, and protocol) must be the same
- Unit number of the measurement device to connect to one RS-485 communications port must be unique (the number must not be used for other measurement device)

In addition, collect the configured setting details for each measurement device (e.g. unit number, measurement type) to collect measured data from EQ100.

■LAN-Connected Measurement Device Settings

Before configuration, define network setup for LAN and sub-LAN connection ports of EQ100. Then define the following settings:

- Connection of LAN-connected measurement device and the LAN/sub-LAN connection port of EQ100.
- Network setup of each measurement device (IP address, subnet mask)

The network setup for the LAN connection measurement device must be configured so as to meet the following conditions:

- The host address must be unique (the same value must not be used for other LAN-connected measurement device)
- The subnet mask value must correspond to the network address

In addition, collect the configured setting details for each measurement device (e.g. IP address, measurement type) to collect measured data from EQ100.

- The 4th octet of the PLC's IP address and that of EQ100's LAN connection port must not be matched. This also applies even if the PLC is connected to the sub-LAN connection port.
- Make sure that the 4th octets of IP addresses are unique when multiple PLCs are connected.
- * The 4th octet of an IP address is, for example, xxx of 192.168.250.xxx.

■ Wireless Device Setup

A wireless device collects measured data via the wireless unit master (WZ-MLAN01). Configuration of the wireless unit master is required. In case of a wireless device unit of unidirectional communication, a combination of its group ID and the wireless unit ID is its identifier.

To a wireless slave unit of command-response communications (CompoWay/F)(WZ-SRS01), an RS-485-connected measurement device is connected. In such a case, a combination of its group ID, wireless unit ID, and the unit number of the RS-485-connected measurement device (CompoWay/F) is its identifier.

When the setting of wireless device unit is finished, make sure to connect a computer and the wireless unit master and use the setup software WZ Manager (included in accessory CD-ROM of WZ-MLAN01) for check the connection before connecting EQ100 and the wireless unit master. This should make problem isolation easier between the wireless device unit and EQ100 when a problem occurs.

Precautions for Correct Use

- Before using a wireless device, perform a wireless connection test at the site to install to check normal communications.

■ Required Setup Items of Measurement Devices

Shown below are setup items of measurement devices required to connect to EQ100.

Shown below are setup items for communications with EQ100 and measurement operation of measurement devices.

For details of configuration, refer to measurement devices' manuals.

Type	Name (Model)	Setup for EQ100 Connection	Basic Measurement Setup for Measurement Devices
RS-485-Connected Measurement Device	Smart Power Monitor (KM-N1-FLK)	- CompoWay/F Unit Number - Communication Speed - Others (data length, stop bits, vertical parity, transmission wait time)	Applied circuit, special CT, VT ratio, rated primary current value, communication protocol
	Power Monitor (KM-N2-FLK)		Applied circuit, special CT, VT ratio, rated primary current value, communication protocol
	Power Monitor (KM-N3-FLK)		Applied circuit, special CT, VT ratio, rated primary current value, communication protocol
	Smart Power Monitor (KM20-B40-FLK)		Special CT, VT ratio, rated primary current value
	Smart Power Monitor (KM100-T□-FLK)		Applied circuit, voltage range, current range, VT primary voltage, CT ratio
	Smart Power Monitor (KM50-□-FLK)		Applied circuit, voltage range, current range, VT primary voltage, CT ratio, dedicated CT type, communications protocol, measurement start time, measurement end time

6 Measurement Device Setup and Connection

Type	Name (Model)	Setup for EQ100 Connection	Basic Measurement Setup for Measurement Devices
	Power Measurement Unit (KM1-PMU1A-FLK)		Electrical system 1 applicable phase wire, measurement block, special CT, electrical system 1 VT ratio, measurement block 1 CT ratio, measurement start time, measurement end time, active input setting
	Dual Power System Measurement Unit (KM1-PMU2A-FLK)		Electrical system 1/2 applicable phase wire, measurement block 1/2 special CT, electrical system 1/2 VT ratio, measurement block 1/2 CT ratio, measurement start time, measurement end time, active input setting
	Pulse/Temperature Input Unit (KM1-EMU8A-FLK)		Event input 1-7 NPN/PNP input mode settings, event input settings 1-7, event input 1-7 input mode setting, temperature unit, temperature compensation 1, pulse conversion coefficient settings 1-7, active input setting
	CT Expansion Unit (KE1-CTD8E)		Electrical system 1/2 applicable phase wire, measurement block 1/2 special CT, electrical system 1/2 VT ratio, measurement block 1/2 CT ratio, measurement start time, measurement end time, active input setting
	1/32 DIN Digital Panel Meter (K3GN-□□□-FLK)		Input type, analog range, pulse frequency
	Digital Panel Meter (K3HB-□□□-FLK3)		Input type, analog range, pulse frequency
	Temperature Controller (E5□C)		Input type, scaling upper limit, scaling lower limit, decimal point position, temperature unit, transmission output type, transmission output upper limit, transmission output lower limit, protocol
LAN-Connected Measurement Device	Air Particle Sensor (ZN-PD□□-S□)	- IP address - Subnet mask	Particle selection 1, particle selection 2, display unit, measurement mode
	Air Thermo Station (ZN-THX21-S□)		Operation mode, measurement mode, collecting mode, measurement frequency
	Portable Power Monitor (ZN-CTX21)		Operation mode, measurement mode, collecting mode, measurement cycle, electric energy reset interval, applied circuit, special CT, used channels, measurement target voltage, measurement range, begin time, end time, start trigger, end trigger, REC recovery upon startup
	Power Sensor Station (ZN-KMX21)		Collecting mode, measurement cycle, Power Sensor /connected monitors, electric energy reset interval, REC recovery upon startup

6 Measurement Device Setup and Connection

Type	Name (Model)	Setup for EQ100 Connection	Basic Measurement Setup for Measurement Devices
	Differential Pressure Station (ZN-DPX21-S□)		Operation mode, measurement mode, collecting mode, measurement frequency
	Air Flow Station (D6FZ-FGX21)		Collecting mode, measurement cycle, conversion coefficient, conversion unit setting, display unit, communication conversion port number
Wireless Device Unit	Wireless Unit Master (WZ-MLAN01)	- IP address - Subnet mask - Others (default gateway, port number) - Group ID - Others (wireless channel, broadcast communications, HTTP port number)	-
	Wireless Unit Slave (CompoWay/F) (WZ-SRS01)	- Wireless Unit ID - Group ID - Others (wireless channel, broadcast communications) - RS-485 (communication speed, data length, stop bits, parity, time-out period)	-
	Wireless Device Thermo-Humidity Sensor (WZ-STH01)	- Wireless Unit ID - Group ID - Others (wireless channel, broadcast communications)	-
	Wireless Device Light Intensity Sensor (WZ-SL01)	- Transmission interval	
	Wireless Device Thermo-Humidity Light Intensity Sensor (WZ-STHL01)		
	Wireless Device CO ₂ Sensor (WZ-SCD01)	- Wireless Unit ID - Group ID - Others (wireless channel, broadcast communications) - Unidirectional communication cycle	-
Wireless Unit Slave (Pulse Count) (WZ-SP01)	- Wireless Unit ID - Group ID - Others (wireless channel, broadcast communications) - Transmission interval	-	

6.2. Connection between EQ100 and Measurement Device

EQ100 and measurement devices can be connected via LAN or RS-485.

Shown below are connection types for measurement devices:

Device Type		Direct Connection		Wireless Master Unit Connection (LAN)	
Name	Model	RS-485 Connection	LAN Connection	Wireless Connection	RS-485 Connection
Smart Power Monitor	KM-N1-FLK	Yes	N/A	N/A	Yes
Power Monitor	KM-N2-FLK	Yes	N/A	N/A	Yes
Power Monitor	KM-N3-FLK	Yes	N/A	N/A	Yes
Smart Power Monitor	KM20-B40-FLK	Yes	N/A	N/A	Yes
Smart Power Monitor	KM100-T□-FLK	Yes	N/A	N/A	Yes
Smart Power Monitor	KM50-□-FLK	Yes	N/A	N/A	Yes
Power Measurement Unit	KM1-PMU1A-FLK	Yes		N/A	Yes
Dual Power System Measurement Unit	KM1-PMU2A-FLK	Yes		N/A	Yes
Pulse/Temperature Input Unit	KM1-EMU8A-FLK	Yes	N/A	N/A	Yes
CT Expansion Unit	KE1-CTD8E	Yes	N/A	N/A	Yes
1/32 DIN Digital Panel Meter	K3GN-□□□-FLK(*1)	Yes	N/A	N/A	Yes
Digital Panel Meter	K3HB-□□□-FLK3(*1)	Yes	N/A	N/A	Yes
Digital Temperature Controller	E5□C(*2)	Yes	N/A	N/A	Yes
Air Particle Sensor	ZN-PD□□-S	N/A	Yes	N/A	Yes (*3)
Air Thermo Station	ZN-THX21-S□	N/A	Yes	N/A	
Portable Power Monitor	ZN-CTX21(*4)	N/A	Yes	N/A	
Power Sensor Station	ZN-KMX21	N/A	Yes	N/A	
Differential Pressure Station	ZN-DPX21-S□	N/A	Yes	N/A	
Air Flow Station	D6FZ-FGX21	N/A	Yes	N/A	
Wireless Unit Master	WZ-MLAN01	N/A	Yes	N/A	
Wireless Unit Slave (CompoWay/F)	WZ-SRS01	N/A	N/A	Yes	N/A
Wireless Device Thermo-Humidity Sensor	WZ-STH01	N/A	N/A	Yes	N/A
Wireless Device Light Intensity Sensor	WZ-SL01	N/A	N/A	Yes	
Wireless Device Thermo-Humidity Light Intensity Sensor	WZ-STHL01	N/A	N/A	Yes	
Wireless Device CO ₂ Sensor	WZ-SCD01	N/A	N/A	Yes	
Wireless Unit Slave (Pulse Count)	WZ-SP01	N/A	N/A	Yes	
Programmable Controller	CJ Series (*5) NJ / NX1P Series	N/A	Yes	N/A	
Modbus RTU Device	-	Yes	N/A	N/A	N/A

- *1: Communication speed is 9.6k/19.2kbps.
- *2: RS-485 communications optional function is required.
- *3: Only one device can be connected to a wireless unit slave (CompoWay/F).
- *4: If the ZN-CTX21 firmware is Ver1.03.00 or later, electric energy can be measured.
- *5: A CPU unit with EtherNet/IP port or an EtherNet/IP unit is required.

For the latest information of supported devices, see the latest EQ100 user's manual.

<http://www.fa.omron.co.jp/>

Precautions for Correct Use

Caution on PLC Connection

- The 4th octet of the PLC's IP address and that of EQ100's LAN connection port must not be matched. This also applies even if the PLC is connected to the sub-LAN connection port.
- Make sure that the 4th octets of IP addresses are unique when multiple PLCs are connected.
- If either "Operation Stop Error" or "Operation Continuation Error" occurred in PLC's CPU unit, EQ100 does not perform logging from the PLC.
If "Low Battery" error occurred in a CPU unit, for example, "Operation Continuation Error" occurs and the EQ100 does not record data from the PLC. Replace the CPU unit's battery before "Low Battery" occurs.
- * The 4th octet of an IP address is, for example, xxx of 192.168.250.xxx.
- * An error due to operation continuation failure does not occur for EQ100 of the firmware version 1.160 or later.

6.2.1. Wiring for LAN-Connected Measurement Device

Connect LAN cables to the following LAN ports for measurement devices.

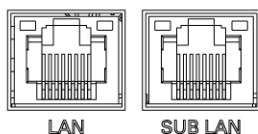

Device	LAN Connection Port	Sub-LAN Connection Port
LAN-Connected Measurement Device	Available	Available

Reference

- Up to 100 measurement devices can be connected.
- Connecting a measurement device to the sub-LAN port of EQ100 as the LAN dedicated to measurement devices enables stable measurement.

Precautions for Correct Use

- An upper level system such as EQ server, SMTP server, SNMP server, and FTP server must be connected to the LAN port.

Connection Example

- Connection Example between EQ100 and LAN-Connected Measurement Device

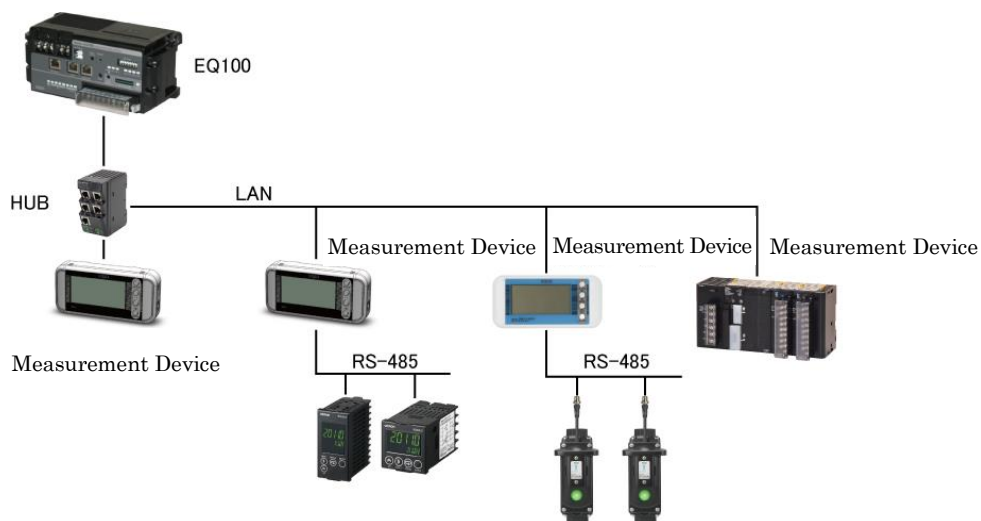

● Connection Example between EQ100 and Wireless Device 1

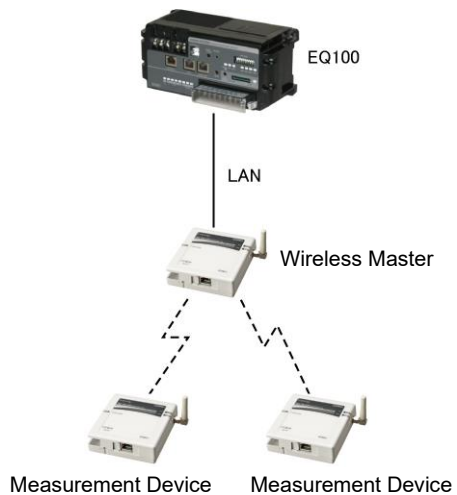

● Connection Example between EQ100 and Wireless Device 2

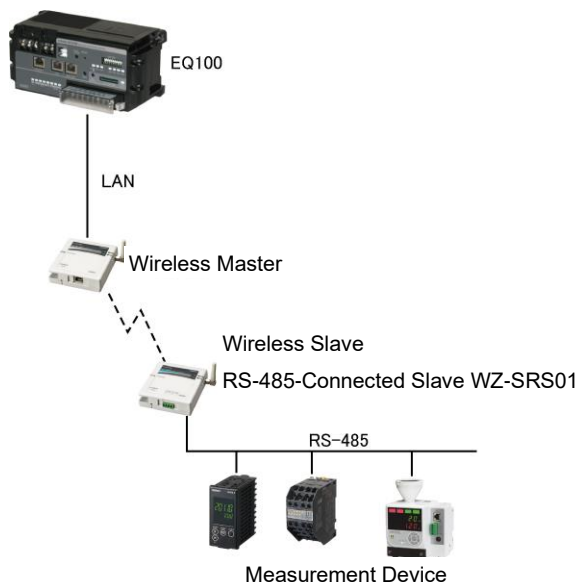

6.2.2. Wiring of RS-485-Connected Measurement Device

EQ100 has four RS-485 communications ports for RS-485-connected measurement devices. Up to 31 measurement devices can be connected to one port (31 x 4 ports= Total 124 devices).

Reference

- Maximum transmission distance is 500m for RS-485 communications.
- For an RS-485 communications port cable, a shielded twisted-pair cable of AWG24 to 14 (0.205 to 2.081 mm²) must be used.
- To prevent malfunction, a shielded wire must be connected to the ground or FG terminal.
- For a device that is connected to the circuit end opposite to this product, a terminal resistor of 120 Ω (1/2W) must be attached (or the built-in terminal resistor, if any, must be enabled).
- The RS-485 communications port terminal has the built-in terminal resistor. The RS-485 communications port cable must be attached so that this product should be on one end of the terminal as shown below.

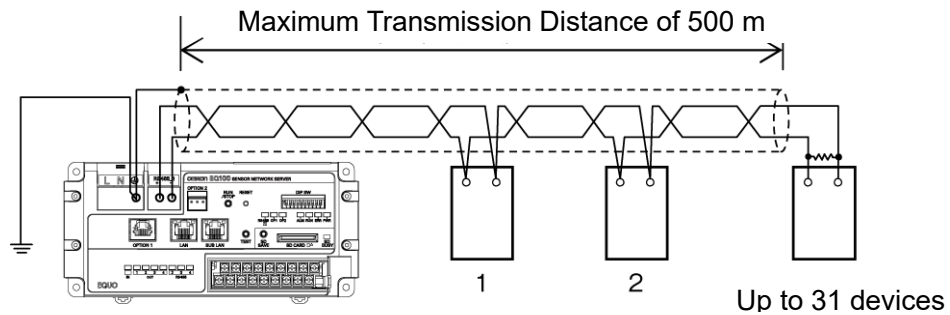

Precautions for Correct Use

- The RS-485 cables must be wired through measurement devices in one loop. Branching and/or star wiring is not available.

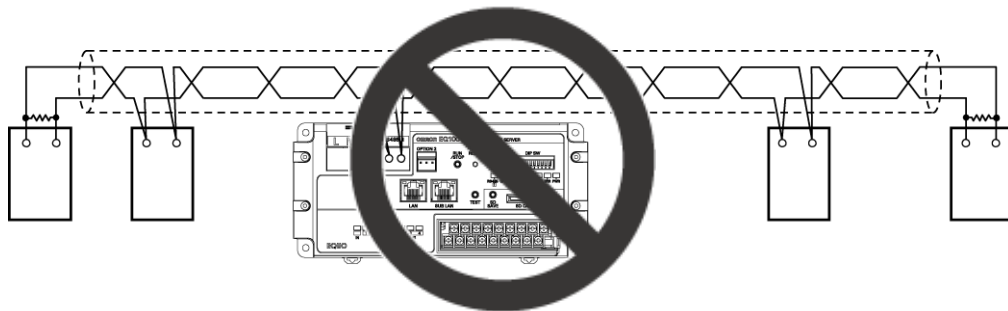

■ Connection Example

● Connection Example between EQ100 and RS-485-Connected Measurement Device

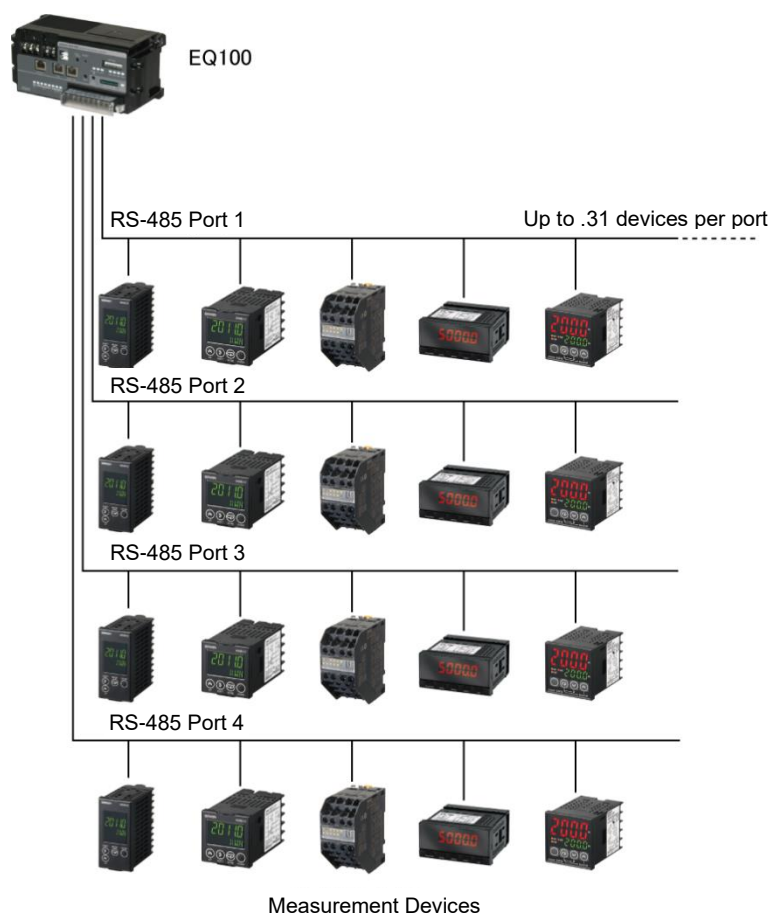

6.2.3. Connection to Pulse Output Measurement Device

A pulse output electric energy meter or flow rate meter can be connected to the general-purpose input terminal of EQ100.

■ Connection Example of EQ100 General-Purpose Input Terminal

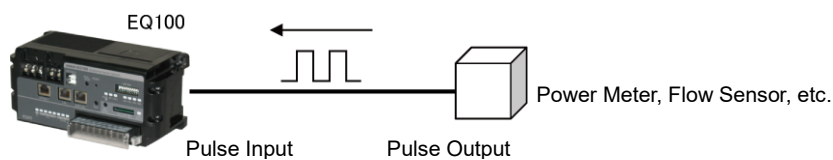

● To Clear Pulse Input Count

To clear the count of the pulse input count channel, in the [Update] menu on the Web UI screen select [Clear Previous Integrated Data] and click [Clear].

7. EQ100 Settings

7.1. Overview of EQ100 Settings

To configure the EQ100 settings, an EQ project is required. An EQ project is a file containing configuration information to operate EQ100. An EQ project is created by EQ-Manager and written to EQ100 to configure EQ100. EQ-Manager is automatically installed upon installation of EQ-Viewer. If there are more than one EQ100, an EQ project must be created for each EQ100.

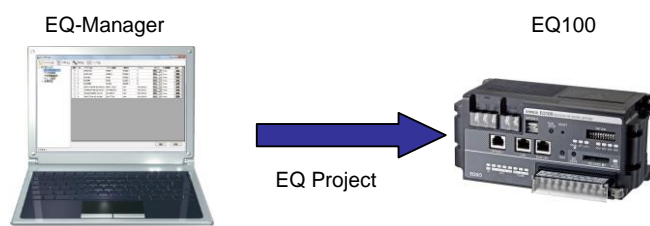

Precautions for Correct Use

- EQ-Manager cannot configure measurement device settings (including communications setting)/measurement settings to be connected to EQ100.
- Measurement devices must be configured before connecting to EQ100.
- For how to configure measurement device settings, refer to user's manual of measurement devices or setup software.

7.2. Creating New EQ Project

Before creating a new EQ project, install EQ-Viewer on a computer.

For how to install EQ-Viewer, see "EQ-Viewer User's Manual".

■ Creation Steps

1) Start up EQ-Manager.

Press the Windows Start button, and click [All Programs] - [OMRON] - [EQ-Viewer] - [EQ-Manager]. Or, double-click the EQ-Manager icon on the desktop.



EQ-Manager is activated.

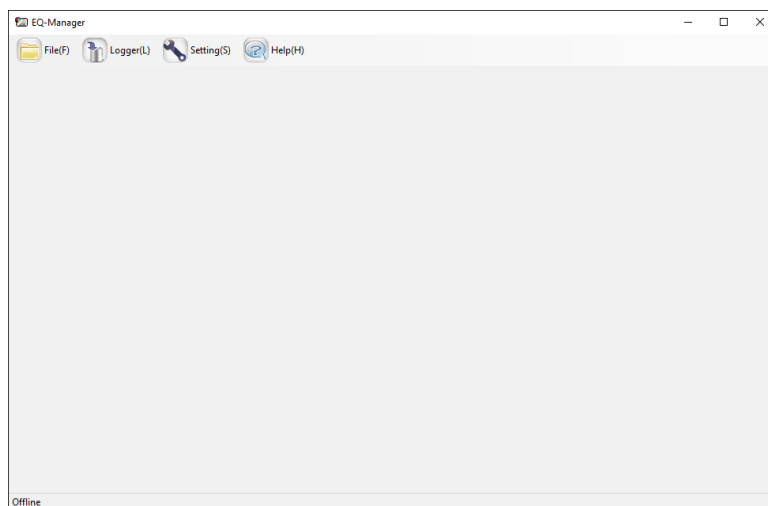

2) Create a new EQ project.

Click [File] - [Create New File] - [EQ Project].

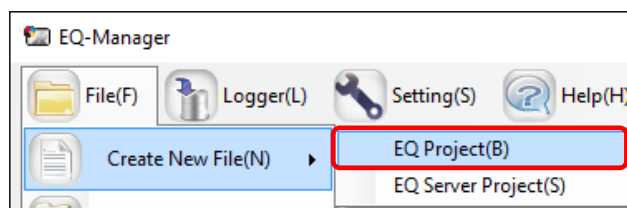

- 3) Input the EQ project name in the [Collecting Device Setting] dialog, and set the time zone.

Note that the time zone can be only set in creating a project.

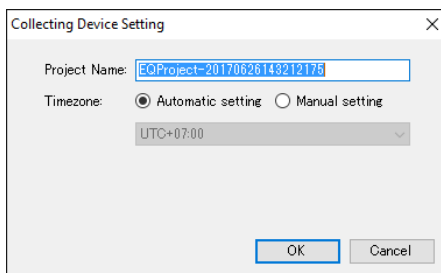

Item	Description
Project name	<Input range> 63 letters
Time zone	Automatic setting: The PC time zone is automatically set. Manual setting: Select the time zone from the following lists: UTC-8, UTC-7, UTC-6, UTC-5, UTC+7, UTC+8, UTC+9

- 4) Click [OK] to view the EQ project setup menu.

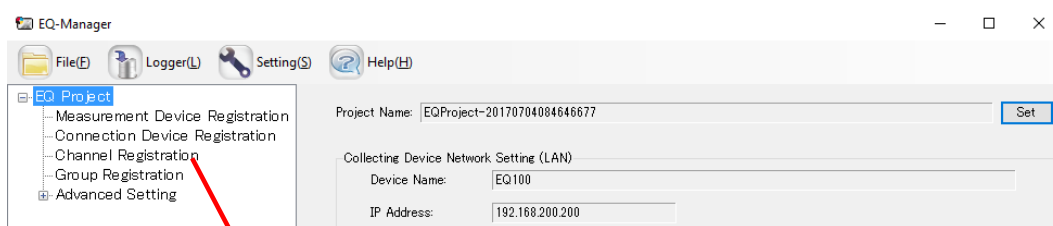

Setting

7.3. Editing EQ100 IP Address/Device Name

This section describes how to edit an EQ project name, device name, and a LAN connection port IP address.

■ Viewing/Editing Setup Screen

Clicking [EQ Project] in the setup menu displays the following screen.

To edit an item, click the respective [Set] button to display the setup dialog box. Edit the item and click [OK].

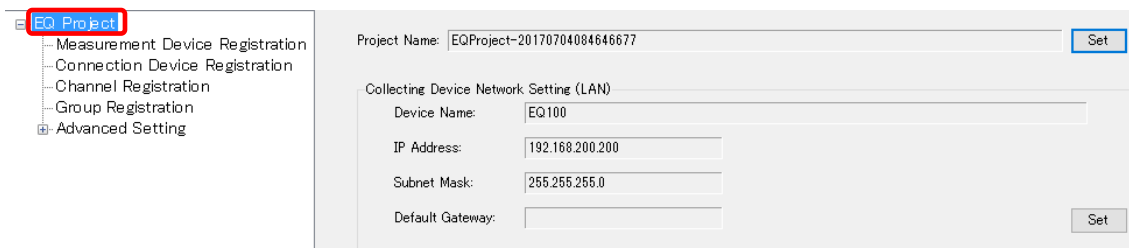

Item Name		Details
Project Name		Edit an EQ project name. When a new EQ project is created, a name entered in the [EQ100 Setting] dialog box appears. <Input range> Half-width 63 characters (Full-width 20 characters, more or less)
Collecting Device Network Setting	Device Name	Set an EQ100 device name. This name is used for EQ-Viewer to identify EQ100. <Input range> Half-width 63 characters (Full-width 20 characters, more or less)
	IP Address	Configure an IP address of EQ100 LAN connection port.(*1) Initial value: 192.168.200.200
	Subnet Mask	Specify the value based on the network environment. Initial value: 255.255.255.0
	Default Gateway	Specify the value based on the network environment. Initial value: None

*1: Be careful not to overlap the sub-LAN segment value when you change the value.

The IP address, subnet mask, and default gateway edited in the screen are synchronized with the LAN connection port configuration in the network setup. Editing either one reflects the settings to the other.

Reference

To configure the sub-LAN connection port, see "8.1.7.6.4. Configuring EQ100 LAN Connection Port/Sub-LAN Connection Port".

7.4. Collecting Setting

7.4.1 Overview

The collecting setting registers measurement devices to connect to EQ100, and registers a channel of the measurement device for collecting.

If necessary, register a connection device, create an operation channel, and/or configure a data type.

Item	Description
Connection Device Registration	Register this item for a wireless device to connect to EQ100.
Measurement Device Registration	Register a measurement device to connect to EQ100. If a measurement device is a wireless one, first Connection Device Registration is required for a connection device that relays EQ100 and the measurement device.
Channel Registration	Select a channel to collect data among channels retained by a measurement device.
Group Registration	Classify channels registered in the Channel Registration. This registration is used to summarize and manage the Web UI screen view by classifying based on areas etc.
Operation Channel Setting	Register an operation result between registered channels as a new channel. e.g.: Sum of electric energy measured for each facility
Data Type Setting	Register and edit a data type. Basic data types are provided by the system. For system-defined data types, see "8.1.7.4.6. Creating/Editing Data Type

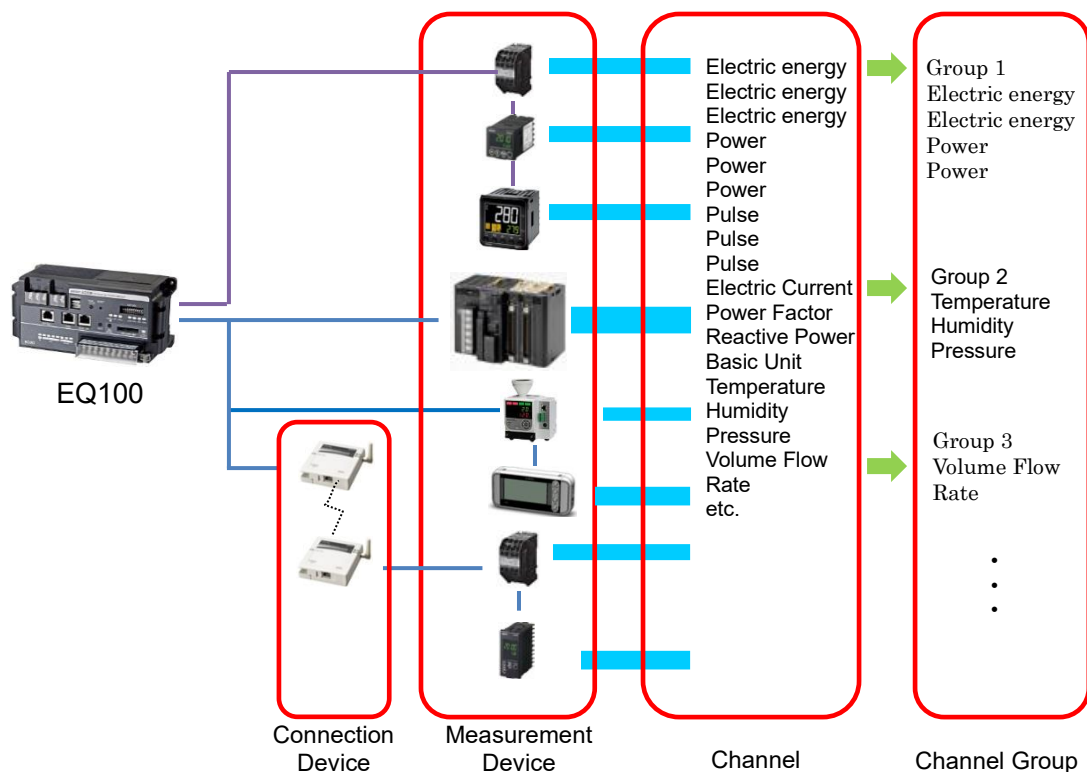

EQ100

Total Power Consumption
 Total Power Consumption
 Total Power Consumption
 Total Power Consumption
 Electric Energy
 Electric Energy
 Electric Energy
 Pulse
 Pulse
 Electric Current
 Power Factor
 Reactive Power
 Base Unit
 Temperature
 Humidity
 Pressure

Group 1
 Total Power Consumption
 Total Power Consumption
 Total Power Consumption
 Electric Energy

 Group 2
 Temperature
 Humidity
 Pressure

 Group 3
 Volume Flow Rate

7.4.2 Connection Device Registration

■Function

This registration is not required if no wireless unit is to be connected.

To connect a measurement device through the wireless master unit, first register the wireless master unit and the wireless/RS-485 converter as a connection device.

A wireless sensor or a RS-485-connected connection device must be registered as a measurement device connected to the wireless master unit or wireless/RS-485 converter registered as its connection device.

Whether a device should be registered as a connection device or a measurement device depends on the measurement function.

See below for registration.

Wireless Unit Type	Function	Registration
Wireless Unit Master WZ-MLAN01	Wireless Master Unit (No measurement function, relaying only)	Register as a connection device
Wireless Unit Slave (CompoWay/F) WZ-SRS01	Wireless RS-485 converter (No measurement function, relaying only)	
Wireless Device Unit	Wireless Slave Unit (with measurement function)	Register as a measurement device with a connection device as its destination
An RS-485-connected device to be connected to a wireless/RS-485 converter	Wireless Device (with measurement function)	

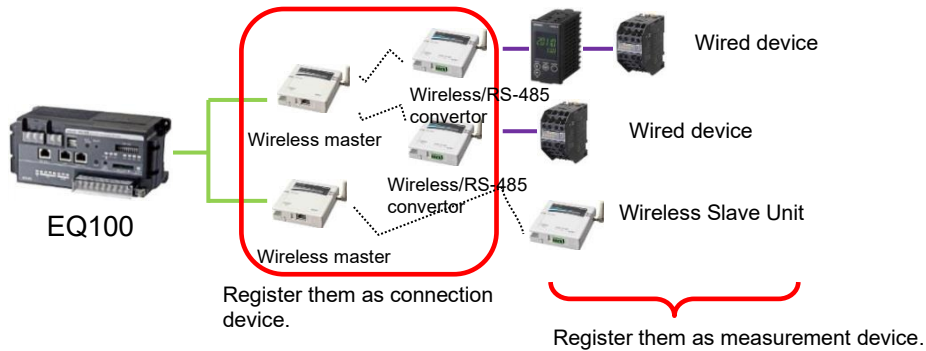

Shown below are connection devices that must be registered before registration of measurement devices.

Measurement Device	Required Connection Device	Remarks
Wireless Device Thermo-Humidity Sensor (WZ-STH01) Wireless Device Light Intensity Sensor (WZ-SL01) Wireless Device Thermo-Humidity Light Intensity Sensor (WZ-STHL01) Wireless Device CO ₂ Sensor (WZ-SCD01) Wireless Unit Slave (Pulse Count)(WZ-SP01)	Wireless Unit Master (WZ-MLAN01)	RS-485 connection of the air particle sensor (ZN-PD□□-S□) is available only through a wireless slave unit (CompoWay/F) (WZ-SRS01). Note that a daisy chain connection with other RS-485-connected measurement device is not available. For details, refer to the user's manual of the air particle sensor.
RS-485-Connected Measurement Device (KM-N□-FLK) (KM20-B40-FLK) (KM100-T□-FLK) (KM50-□-FLK) (KM1-PMU1A-FLK) (KM1-PMU2A-FLK) (KM1-EMU8A-FLK) (KE1-CTD8E-FLK) (ZN-PD□□-S□) (K3GN-□□□-FLK) (K3HB-□□□-FLK3) (E5□C)	Wireless Unit Master (WZ-MLAN01) Wireless Unit Slave (CompoWay/F) (WZ-SRS01)	

■ Setup Steps

1) In the setting menu, click [Connection Device Registration].



Precautions

- To register a wireless unit slave (CompoWay/F) (WZ-SRS01), first add the wireless master unit as a destination. If a wireless master device is not registered, the wireless master device cannot be configured in a selection of destination to connect even if you try to register a wireless/RS-485 converter (WZ-SRS01).

2) Click [Add].

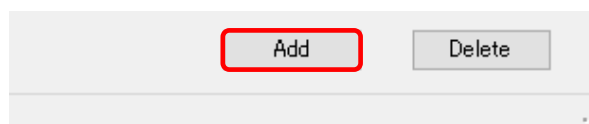

3) In the [Add Connection Device] dialog box, enter registration items for the connection device.

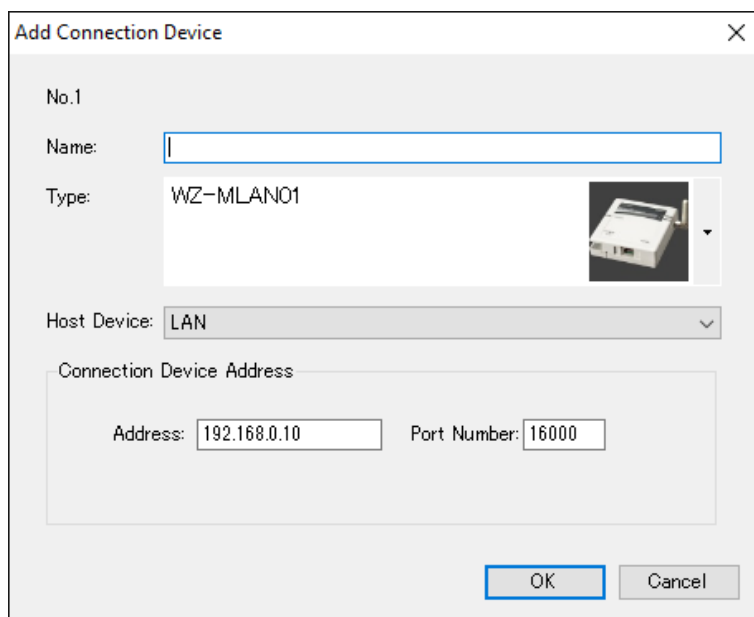

Item	Description
Name	Enter a name of the connection device. If not entered, "model"+"#"+"connection device address" is automatically set. <Input range> Half-width63 characters (Full-width 20 characters, more or less)
Type	A list of connection device types appears. Select a connection device type. - For a wireless unit master, select [WZ-MLAN01]. - For a wireless unit slave (CompoWay/F), select [WZ-SRS01].
Host Unit	Select an upstream destination for the connection device. - For a wireless unit master, select [LAN]. - For a wireless unit slave (CompoWay/F), select a device name of the wireless unit master to connect.

Item	Description
Connection Device Address	Enter an address of the connection device selected in the connection device type. Details depend on a selected connection device type. - For a wireless unit master, enter an IP address and a port number. - For a wireless unit slave (CompoWay/F), enter a wireless unit ID.

4) Clicking [OK] adds the connection device to the list.

■ Editing Connection Device

To change registration details of a connection device:

1) Click the [Edit] button of the connection device you want to change.

<input type="checkbox"/>	1	WZ-MLAN01#192.168.0.10	WZ-MLAN01	LAN	192.168.0.10	16000	Edit
--------------------------	---	------------------------	-----------	-----	--------------	-------	-------------

2) In the [Edit Connection Device] dialog box, change the registration details.

3) Clicking [OK] changes the registration of the connection device.

■ Deleting Connection Device

1) In the [Connection Device Registration] screen, select the [Select] check box.

2) Click [Delete].

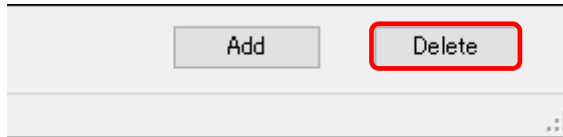

Precautions for Correct Use

- A connection device cannot be deleted if a measurement device or a wireless slave device is being registered downstream of the connection device. First delete the measurement device or the wireless slave device before deleting the connection device.

7.4.3 Measurement Device Registration

■ Function

Register a measurement device to connect to EQ100.

To use a wireless device, first register a connection device before registering a measurement device.

To use the general-purpose input, register pulse input as a measurement device.

■ Adding Measurement Device

1) In the setting menu, click [Measurement Device Registration].

EQ Project	Measurement Device Registration	Select	No.	Measurement Device Name	Device Type	Host Device	Address	Logging	Measurement Cycle	Edit
	Connection Device Registration									

2) Click [Add].

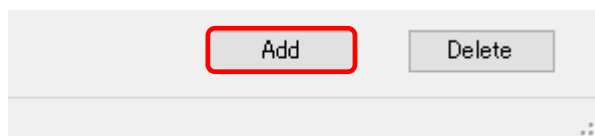

3) In the [Add Measurement Device] dialog box, enter the registration details.
Details depend on a measurement device type to register.

<LAN-Connected Measurement Device>

The screenshot shows a dialog box titled "Add Measurement Device" with a close button (X) in the top right corner. The dialog is divided into several sections:

- No.1**: A label for the device number.
- Device Name**: A text input field.
- Device Type**: A dropdown menu showing "ZN-KMX21" with a small device icon to its right.
- Setting Items**: A section containing five settings:
 - Host Device**: A dropdown menu set to "LAN".
 - IP Address**: A text input field containing "192.168.0.20".
 - Connection Count**: A text input field containing "1".
 - Measurement Cycle**: A dropdown menu set to "10 min".
 - Timeout**: A dropdown menu set to "500 ms".
- Registration Options**: Two checked checkboxes:
 - Default Channel Registration
 - Destination Group to Add
- Group**: A dropdown menu.
- Buttons**: Three buttons at the bottom: "Batch Registration", "OK" (highlighted with a blue border), and "Cancel".

Item	Description
Device Name	Enter a name of the measurement device. If not entered, "model"+"#"+"IP address" is automatically set. <Input range> Half-width63 characters (Full-width 20 characters, more or less)
Device Type	A list of measurement device types appears. Select a measurement device type to add.
Setting Items	Details depend on a selected measurement device type. [Host Device]: Select [LAN]. [IP Address]: Enter an IP address of the measurement device. [Connection count]: For only collecting devices such as Power Sensor Station and Air Flow Station, enter the number of connections of the downstream measurement devices. <Input range> 1 to 31 devices [Measurement Cycle]: Select a collecting interval for the measurement device. <Selection> 1min/5min/10min/30min/60min [Port No.]: Enter a port number to use. [Timeout]: Select a time period to evaluate no communication response from the measurement device. <Selection: LAN> 500ms/1s/2s/5s/10s <Selection: Connection Device> 1s/2s/5s/10s/20s/30s
Default Channel Registration	This function saves operations to channel registration and group registration described later. If the [Default Channel Registration] check box is selected, channel registration and group registration can be done at the same time by measurement device registration. <Default Channel Registration> Major channels of the measurement device are automatically registered. Channels that are automatically registered are defined upon factory shipment, including the channel names. Note that the channel names can be changed later. Note that simultaneous registration is not available for PLC. You must register the channels later. <Destination Group to Add> If the [Destination Group to Add] check box is selected, measurement device channels can be registered to a specified group at the same time. To use this function, first register a group. For registration, see "8.1.7.4.7. Group Registration". Note that performing the default registration without performing group registration registers to a default "group".
Batch Registration	Use this function to register multiple measurement devices of the same type together. For how to register, see "■ Batch Registration".

Precautions for Correct Use

Caution on PLC Connection

- The 4th octet of the PLC's IP address and that of EQ100's LAN connection port must not be matched. This also applies even if the PLC is connected to the sub-LAN connection port.
- Make sure that the 4th octets of IP addresses are unique when multiple PLCs are connected.
- If either "Operation Stop Error" or "Operation Continuation Error" occurred in PLC's CPU unit, EQ100 does not perform logging from the PLC.
If "Low Battery" error occurred in a CPU unit, for example, "Operation Continuation Error" occurs and the EQ100 does not record data from the PLC. Replace the CPU unit's battery before "Low Battery" occurs.

* The 4th octet of an IP address is, for example, xxx of 192.168.250.xxx.

* An error due to operation continuation failure does not occur for EQ100 of the firmware version 1.160 or later.

<Wireless Measurement Device>

Add Measurement Device [X]

No.1

Device Name:

Device Type:
WZ-STH01 

Setting Items

Host Device:

Wireless Unit ID:

Measurement Cycle:

Default Channel Registration

Destination Group to Add:

Batch Registration OK Cancel

Setting Item	Description
Device Name	Enter a name of the measurement device. If not entered, "model"+"#"+"wireless unit ID" is automatically set. <Input range> Half-width63 characters (Full-width 20 characters, more or less)
Device Type	A list of measurement device types appears. Select a measurement device type to add.
Setting Items	Details depend on a selected measurement device type. [Host Device]: Select the wireless master unit. [Wireless Unit ID]: Enter the wireless unit ID. [Measurement Cycle]: Select a collecting interval for the measurement device. <Selection> 1min/5min/10min/30min/60min

Setting Item	Description
Default Channel Registration	<p>This function saves operations to channel registration and group registration described later. If the [Default Channel Registration] check box is selected, channel registration and group registration can be done at the same time by measurement device registration.</p> <p><Default Channel Registration></p> <p>Major channels of the measurement device are automatically registered. Channels that are automatically registered are defined upon factory shipment, including the channel names.</p> <p>Note that the channel names can be changed later.</p> <p><Destination Group to Add></p> <p>If the [Destination Group to Add] check box is selected, measurement device channels can be registered to a specified group at the same time. To use this function, first register a group.</p> <p>For registration, see "8.1.7.4.7. Group Registration".</p> <p>Note that performing the default registration without performing group registration registers to a default "group".</p>
Batch Reg.	<p>Use this function to register multiple measurement devices of the same type together. For how to register, see "■ Batch Registration".</p>

Precautions for Correct Use

- Before configuring "Details/Destination", the wireless master device must be registered. For registration, see "7.4.2. Connection Device Registration".

<RS-485-Connected Measurement Device>

CompoWay/F

Setting Item	Description
Device Name	Enter a name of the measurement device. If not entered, "model"+"#"+"CompoWay/F unit number" is automatically set. <Input range> Half-width63 characters (Full-width 20 characters, more or less)
Device Type	A list of measurement device types appears. Select a measurement device type to add.
Setting Items	Details depend on a selected measurement device type. [Host Device]: Select an RS-485 port number, from [RS-485_1] to [RS-485_4]. Or select [SRS01]. [CompoWay/F Unit No]: Enter a CompoWay/F unit number of the measurement device. <Input range> 1 to 31 [Measurement Cycle]: Select a collecting interval for the measurement device. <Selection> 1min/5min/10min/30min/60min [Timeout]: Select a time period to evaluate no communication response from the measurement device. <Selection> 100ms/200ms/500ms/1s/2s/5s/10s/20s/30s

Setting Item	Description
Default Channel Registration	<p>This function saves operations to channel registration and group registration described later. If the [Default Channel Registration] check box is selected, channel registration and group registration can be done at the same time by measurement device registration.</p> <p><Default Channel Registration></p> <p>Major channels of the measurement device are automatically registered. Channels that are automatically registered are defined upon factory shipment, including the channel names.</p> <p>Note that the channel names can be changed later.</p> <p>Selecting Default Channel Registration for K3GN-□□□-FLK, E5CC, or E5EC results in definition on factory shipment other than channel names. If you need to change the settings, unselect the Default Channel Registration check box.</p> <p><Destination Group to Add></p> <p>If the [Destination Group to Add] check box is selected, measurement device channels can be registered to a specified group at the same time. To use this function, first register a group. For registration, see "8.1.7.4.7. Group Registration".</p> <p>Note that performing the default registration without performing group registration registers to a default "group".</p>
Batch Registration	<p>Use this function to register multiple measurement devices of the same type together. For how to register, see "■ Batch Registration".</p>

<RS-485-Connected Measurement Device>

Modbus RTU

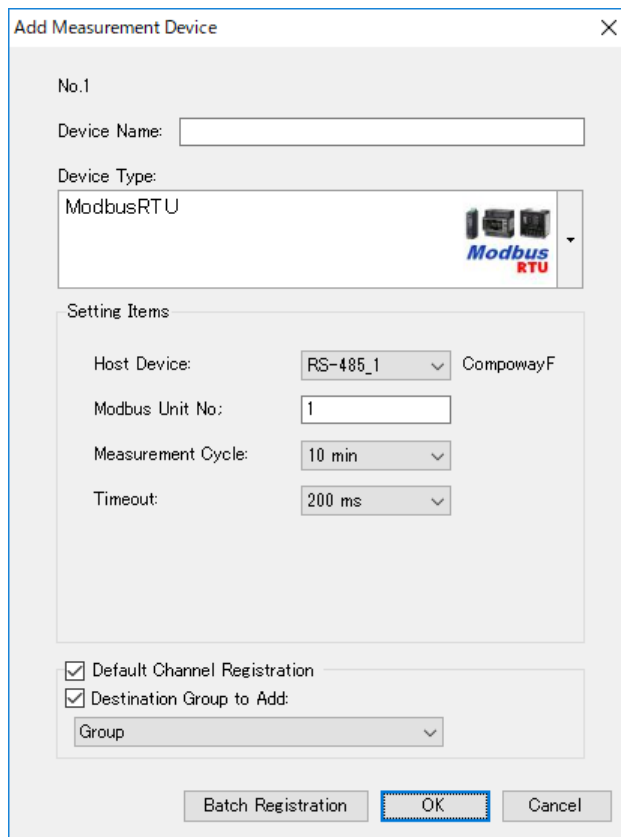

Setting Item	Description
Device Name	Enter a name of the measurement device. If not entered, "model"+"#"+"Modbus RTU unit number" is automatically set. <Input range> Half-width63 characters (Full-width 20 characters, more or less)
Device Type	A list of measurement device types appears. Select a Modbus RTU device type.
Setting Items	Details depend on a selected measurement device type. [Host Device]: Select an RS-485 port number, from [RS-485_1] to [RS-485_4]. [CompoWay/F Unit No]: Enter a Modbus RTU unit number of the measurement device. <Input range> 1 to 31 [Measurement Cycle]: Select a collecting interval for the measurement device. <Selection> 1min/5min/10min/30min/60min [Timeout]: Select a time period to evaluate no communication response from the measurement device. <Selection> 100ms/200ms/500ms/1s/2s/5s/10s/20s/30s
Batch Registration	Use this function to register multiple measurement devices of the same type together. For how to register, see "■ Batch Registration".

<EQ100 General-Purpose Input Terminal (Pulse Input) Measurement Device>

Setting Item	Description
Device Name	Enter a name of the measurement device. If not entered, "EQ100 PULSE"+"#" is automatically set. <Input range> Half-width63 characters (Full-width 20 characters, more or less)
Device Type	Select [EQ100 PULSE].
Setting Items	Details depend on a selected measurement device type. [Measurement Cycle]: Select a collecting interval for the measurement device. <Selection> 1min/5min/10min/30min/60min

Setting Item	Description
Default Channel Registration	<p data-bbox="483 230 863 259"><Default Channel Registration></p> <p data-bbox="483 271 1385 378">One channel of [EQ100 PULSE] can be registered to channel registration and group registration. Channels that are automatically registered are defined upon factory shipment, including the channel names.</p> <p data-bbox="483 389 1123 418">Note that the channel names can be changed later.</p> <p data-bbox="483 430 820 459"><Destination Group to Add></p> <p data-bbox="483 470 1350 539">If the [Destination group to Add] check box is selected, measurement device channels can be registered to a specified group at the same time.</p> <p data-bbox="483 551 979 580">To use this function, first register a group.</p> <p data-bbox="483 591 1102 620">For registration, see "8.1.7.4.7. Group Registration".</p> <p data-bbox="483 631 1339 701">Note that performing the default registration without performing group registration registers to a default "group".</p>

3) Clicking [OK] registers the measurement device.

■ Batch Registration

Multiple measurement devices can be registered together in the [Add Measurement Device] dialog box.

This function, however, configures the same settings for device address and others. You need to edit the settings after the batch registration.

In this section, assume batch registration of KM100 as an example.

- 1) In the [Add Measurement Device] dialog box, click the [Batch Registration] button.

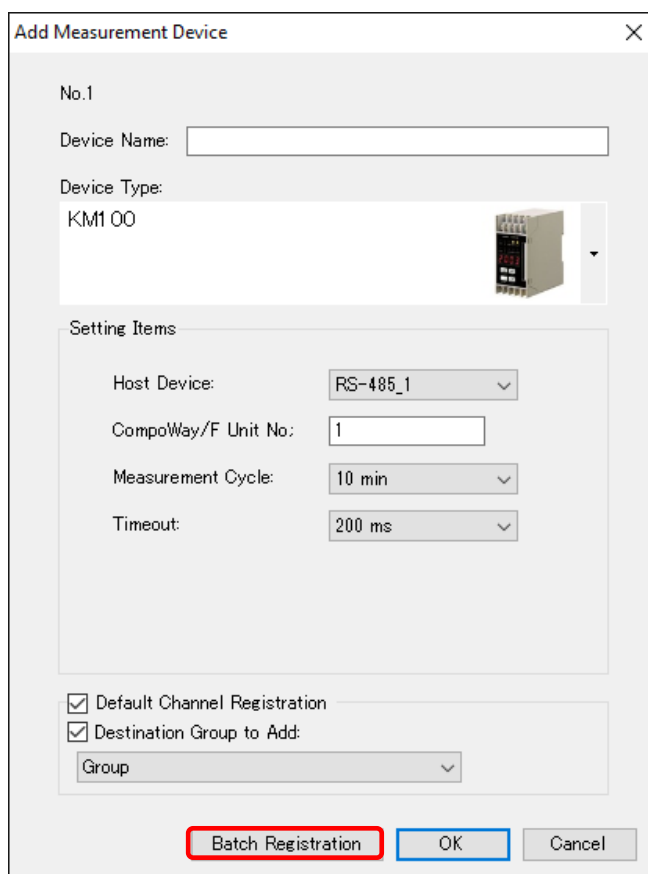

The screenshot shows the 'Add Measurement Device' dialog box. It has a title bar with a close button (X). The main area is divided into several sections:

- No.1**: A label for the device number.
- Device Name**: An empty text input field.
- Device Type**: A dropdown menu showing 'KM100' with a small image of the device to its right.
- Setting Items**: A section containing four settings, each with a dropdown menu:
 - Host Device: RS-485_1
 - CompoWay/F Unit No.: 1
 - Measurement Cycle: 10 min
 - Timeout: 200 ms
- Registration Options**: Two checked checkboxes:
 - Default Channel Registration
 - Destination Group to Add:
- Group**: A dropdown menu showing 'Group'.
- Buttons**: Three buttons at the bottom: 'Batch Registration' (highlighted with a red box), 'OK', and 'Cancel'.

- 2) In the [Batch Registration] dialog box, enter the details.

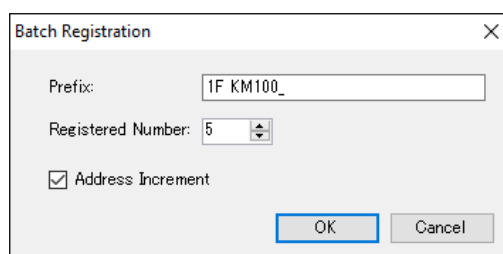

The screenshot shows the 'Batch Registration' dialog box. It has a title bar with a close button (X). The main area contains:

- Prefix**: A text input field containing '1F KM100_'.
- Registered Number**: A spin box set to '5'.
- Address Increment**: A checked checkbox.
- Buttons**: Two buttons at the bottom: 'OK' and 'Cancel'.

Setting Item	Description
Prefix	In the Prefix field, a device name entered in the [Add Device] dialog box appears. If not entered, enter a prefix here. For example, if you enter a prefix name as "1st floor KM100_" and 5 devices as the number of devices to register, the devices are registered as names with a serial number added to the end, as "1st floor KM100_1", "1st floor KM100_2", ... "1st floor KM100_5". <Input range> Half-width 63 characters (Full-width 20 characters, more or less)
Registered Number	Enter the number of measurement devices to register.
Address Increment	If you select this check box, you can register IP addresses or unit numbers increased step-by-step by one from the one entered in the [Add Measurement Device] screen. If cleared, the same values are entered as the address.

3) Clicking [OK] registers KM100 together.

Select	No.	Measurement Device Name	Device Type	Host Device	Address	Logging	Measurement Cycle	Edit
<input type="checkbox"/>	1	1F KM100_1	KM100	RS-485_1	1	En	10 min	Edit
<input type="checkbox"/>	2	1F KM100_2	KM100	RS-485_1	2	En	10 min	Edit
<input type="checkbox"/>	3	1F KM100_3	KM100	RS-485_1	3	En	10 min	Edit
<input type="checkbox"/>	4	1F KM100_4	KM100	RS-485_1	4	En	10 min	Edit
<input type="checkbox"/>	5	1F KM100_5	KM100	RS-485_1	5	En	10 min	Edit

A number is added to the tail sequentially.

Selecting the [Address Increment] check box increments addresses by one.

4) If the batch-registered address and/or measurement cycle are not desirable, modify the value.

To modify, click the [Edit] button of the device name you want to modify. For operations, see " ■ Editing Measurement Device" in the later section.

■ Editing Measurement Device

To change registration details of a measurement device:

1) Click the [Edit] button of the measurement device you want to change.

<input type="checkbox"/>	6	ZN-KMX21#192.168.0.20	ZN-KMX21	LAN	192.168.0.20	En	10 min	Edit
--------------------------	---	-----------------------	----------	-----	--------------	----	--------	------

2) In the [Edit Measurement Device] dialog box, change the registration details.

Note that you cannot edit the default channel registration and group to add. You must edit on the channel registration and group registration.

3) Clicking [OK] changes the registration of the measurement device.

Precautions for Correct Use

- If a measurement cycle of a measurement device is changed to a longer value during the system operations, total values for one cycle including the changed hour cannot be properly collected.

■Deleting Measurement Device

1) In the [Measurement Device Registration] screen, select the [Select] check box.

2) Click [Delete].

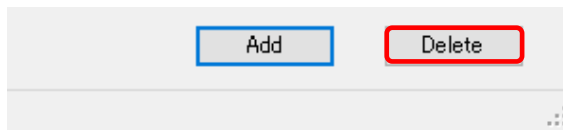

3) In the confirmation dialog box, click [Yes] if you are sure.

Precautions for Correct Use

- Deleting a measurement device deletes its channels that are registered as well.

■Enabling/Disabling Logging

You can stop logging from a measurement device while keeping the measurement device registration as it is.

1) In the [Measurement Device Registration] screen, change the setting of enabling/disabling [Logging].

Select	No.	Measurement Device Name	Device Type	Host Device	Address	Logging	Measurement Cycle	Edit
<input checked="" type="checkbox"/>	1	1F KM100_1	KM100	RS-485_1	1	En	10 min	Edit
<input type="checkbox"/>	2	1F KM100_2	KM100	RS-485_1	2	En (Dis)	10 min	Edit
<input type="checkbox"/>	3	1F KM100_3	KM100	RS-485_1	3	En	10 min	Edit

Setting Item	Description
Logging	En (Enable): Collecting from the measurement device is available. Dis (Disable): Collecting is not done from the measurement device even if the logging is started.

7.4.4 Channel Registration

■Function

Required channels of those retained by a measurement device can be registered as EQ100 collecting target.

Depending on a registered measurement device and default channel registration, number of channels to register and registration steps differ.

Condition	Registration Availability/Method
Default channel registration has been done on device registration	Major channels have been registered already. If necessary, change the channel registration.
Default channel registration has not been done on device registration	Manually register the channels.
Measurement device is PLC	

■Adding Channels

1) In the setting menu, click [Channel Registration].



2) Click [Add].

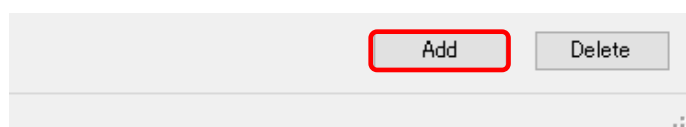

3) In the [Add Channel] dialog box, register the channels you want.

Select a measurement device of the channels you want to register.

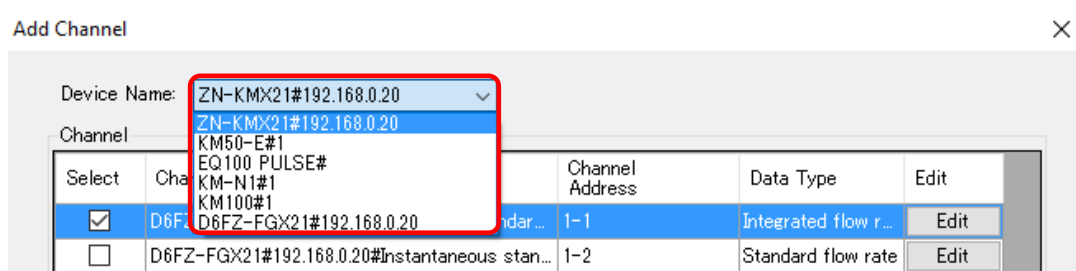

Depending on the selected device, the screen switches. The settings differ depending on PLC, Modbus RTU, general-purpose input, or others. Configure as shown below.

<PLC>

The screenshot shows the 'Add Channel' dialog box with the following settings:

- Device Name: CJ1#192.168.250.1
- Channel Name: CJ1#192.168.250.1#CIO-0001-0
- Data Type: Electric energy
- Type: Boolean
- Variable Area: CIO
- Start Address: 1
- Start Bit: 0
- Differential Processing: No
- Preprocess: Coefficient: 1, Constant Value: 0
- Range of Values: Max. Value: , Min. Value:
- Destination Group to Add: Group

Setting Item	Description
Device Name	Enter a name of the PLC measurement device.
Channel Name	Enter a channel name. If not entered, "Measurement Device Name"+"#"+"channel address" is automatically set. <Input range> Half-width63 characters (Full-width 20 characters, more or less)
Data Type	Select a data type.
Type	Select a data type.
Variable Area	Select an area type of I/O memory.
Start Address	Enter the start address.
Start Bit	Select the start bit.
Differential Processing	Select Yes or No for differential processing. No: A channel is handled as an instantaneous value. Yes: A channel is handled as an integrated value.
Preprocess	Click [Edit] and enter a coefficient and a constant value.
Range of Values	Specify a maximum value for a target to read if the differential processing is required. Configuring this allows proper differential processing even if a value is reset to 0 after reaching the maximum value. The minimum value is fixed to 0.
Destination Group to Add	If the [Destination Group to Add] check box is selected, channels can be registered to a specified group at the same time. To use this function, first register a group. For registration, see "8.1.7.4.7. Group Registration". Note that performing the registration without performing group registration registers to a default "group".

<Modbus RTU>

The screenshot shows the 'Add Channel' dialog box with the following settings:

- Device Name: ModbusRTU#1
- Channel Name: (empty)
- Data Type: Electric energy
- Function code: 03
- Starting Address: 1
- Quantity of Registers: 1
- Type: Integer
- Byte order: Big Endian
- Differential Processing: No
- Preprocess: Coefficient: 1, Constant Value: 0
- Range of Values: (unchecked)
- Destination Group to Add: (checked) Group

Setting Item	Description
Device Name	Enter a name of the Modbus RTU measurement device.
Channel Name	Enter a channel name. If not entered, "Measurement Device Name"+"#"+"channel address" is automatically set. <Input range> Half-width63 characters (Full-width 20 characters, more or less)
Data Type	Select the data type.
Function code	Select a function code from 01, 02, 03, or 04.
Start Address	Enter the start address.
No. of Registers	Automatically set from the model.
Type	Select the data type.
Byte order	Select the byte order of data.
Differential Processing	Select Yes or No for differential processing. No: A channel is handled as an instantaneous value. Yes: A channel is handled as an integrated value.
Preprocess	Click [Edit] and enter a coefficient and a constant value.
Range of Values	Specify a maximum value for a target to read if the differential processing is required. Configuring this allows proper differential processing even if a value is reset to 0 after reaching the maximum value. The minimum value is fixed to 0.
Destination Group to Add	If the [Destination Group to Add] check box is selected, channels can be registered to a specified group at the same time. To use this function, first register a group. For registration, see "8.1.7.4.7. Group Registration". Note that performing the registration without performing group registration registers to a default "group".

<General-Purpose Input>

Setting Item	Description
Device Name	Enter a name of a device connected to the EQ100 general-purpose input terminal.
Channel Name	Enter a channel name. If not entered, "device name"+"#"+"PULSE" is automatically set.
Destination Group to Add	If the [Destination Group to Add] check box is selected, channels can be registered to a specified group at the same time. To use this function, first register a group. For registration, see "8.1.7.4.7. Group Registration". Note that performing the registration without performing group registration registers to a default "group".

* Setup values displayed in the [Add Channel] dialog box but not listed in the table above are handled as fixed values. They cannot be operated.

Precautions for Correct Use

- To convert a value measured in the general-purpose input terminal, create a free operation channel in the operation channel setting. For details, see "8.1.7.4.5. Operation Channel Setting".

<Others (other than PLC/EQ-100 connected to General-Purpose Input terminals)>
 Select the [Select] check box of the channel you want to register. The channels that have been registered already are shaded with their check boxes being selected.

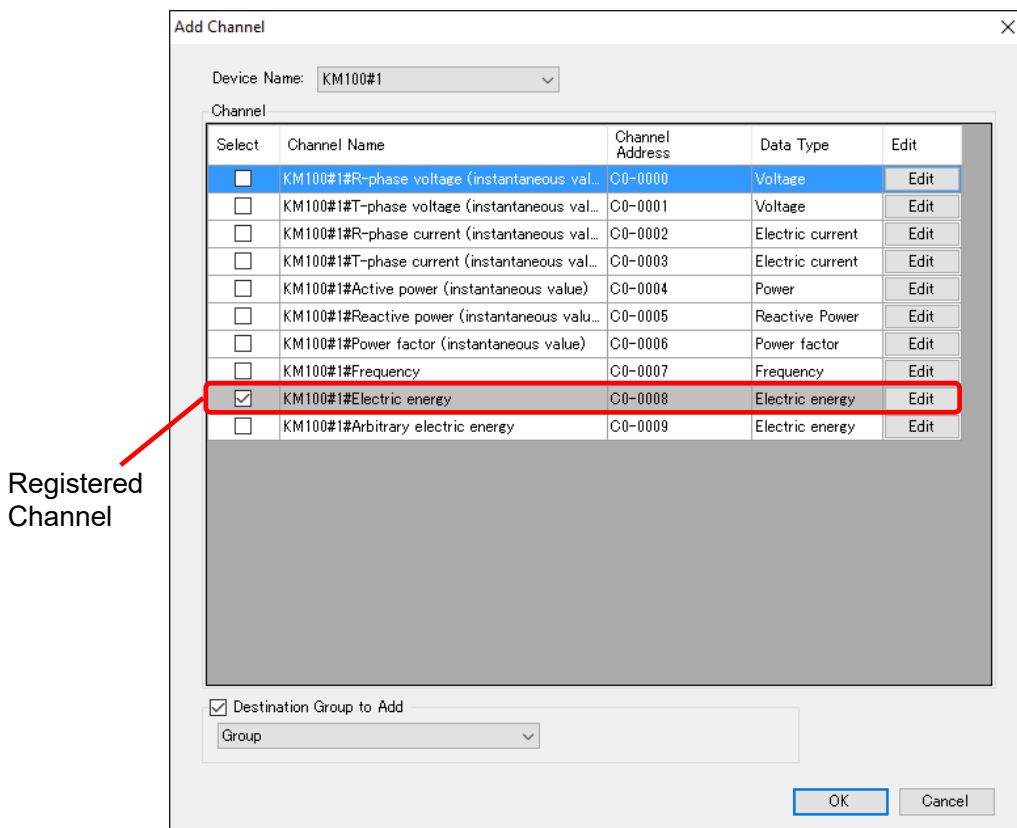

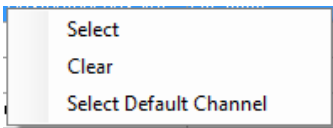
Setting Item	Description
Select	Select a channel you want to register for collecting. Right-clicking shows the following menu, in which [Select], [Cancel], and [Select the default channel] are available. 
Channel Name	A channel name appears. To change, press the [Edit] button.
Channel Address	A channel address appears.
Data Type	A channel type appears.
Edit	Clicking this displays a dialog box to change the channel name and input parameter (only those available).
Destination Group to Add	If the [Destination Group to Add] check box is selected, channels can be registered to a specified group at the same time. To use this function, first register a group. For registration, see "8.1.7.4.7. Group Registration". Note that performing the registration without performing group registration registers to a default "group".

4) Clicking [OK] registers the channel with the specified configuration.

- 5) To add more channels, repeat the steps from 1) to 3).
 (Editing when the parameter change is available)

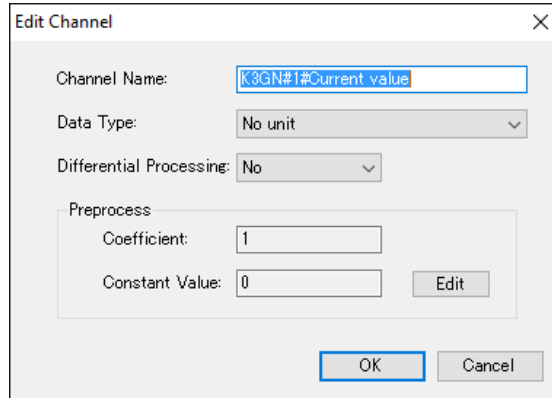

Setting Item	Description
Channel Name	Enter a channel name. If not entered, the created default name is set.
Data Type	Select a data type.
Differential Processing	Select Yes or No for differential processing. No: A channel is handled as an instantaneous value. Yes: A channel is handled as an integrated value.
Preprocess	Click [Edit] and enter a coefficient and a constant value. For the coefficient, enter a proper value by referring to decimal point information in the communications manual of the measurement device. The constant value must be 0 if a measured value of a measurement device is used as a channel value. Example of Coefficient Input - The decimal point position in the sensor's communications manual is one decimal place > Preprocess input value is 0.1 - The decimal point position in the sensor's communications manual is four decimal place > Preprocess input value is 0.0001

You cannot change the setting parameters other than the above.

If you need to change the parameters, delete the channel once and perform channel registration again.

(Other Edit)

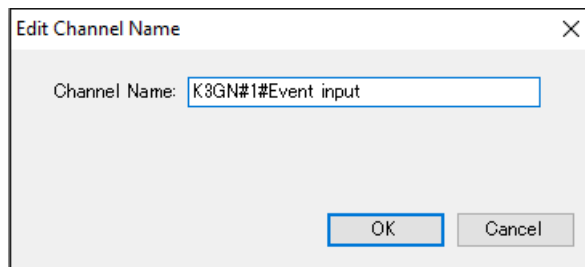

Setting Item	Description
Channel Name	Enter a channel name. If not entered, a default name is automatically set.

■ Editing Channel

You can edit a channel name only.

1) Click the [Edit] button of the channel you want to change.



2) In the [Edit Measurement Device] dialog box, click [Edit].

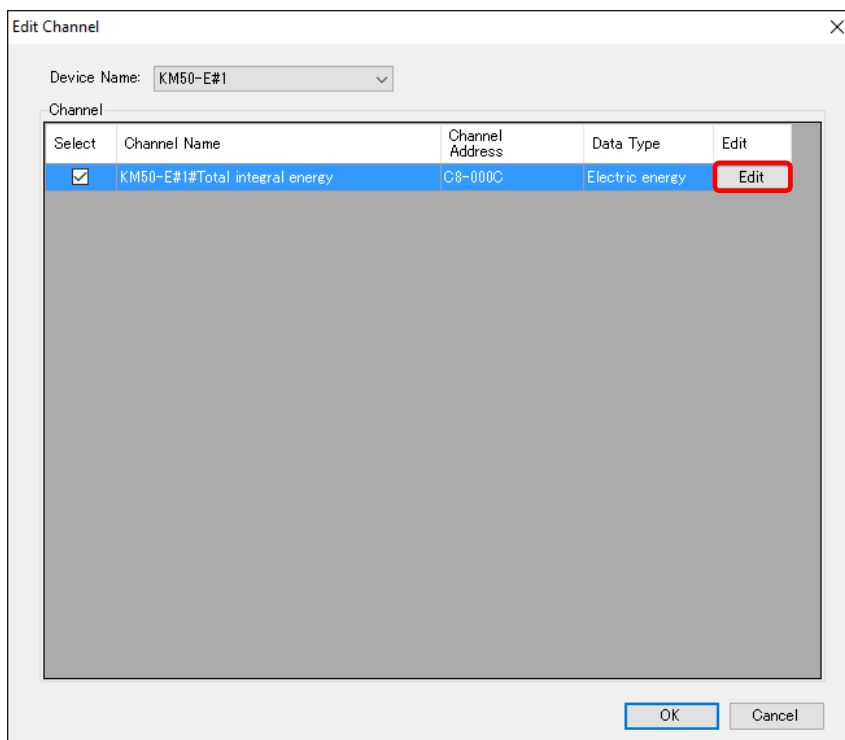

3) In the [Edit Channel Name] dialog box, change the channel name and click [OK].

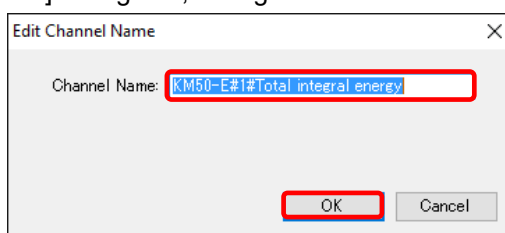

■ Deleting Channel

1) In the [Channel Registration] screen, select the [Select] check box.

2) Click [Delete].

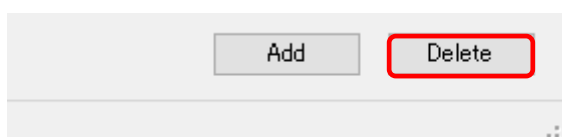

3) In the confirmation dialog box, click [Yes] if you are sure.

■ Channel Batch-Edit

You can view a list of multiple channels and edit the channel names together.

- 1) On the bottom of the screen, click the [Channel Batch-Edit] button.

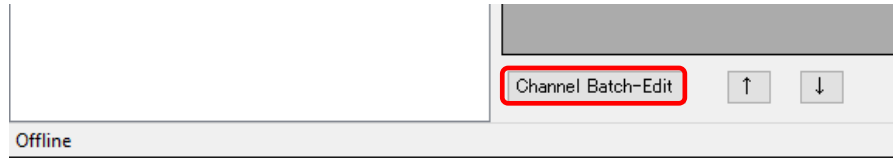

- 2) Click the field of the channel you want to edit, and edit the item directly.

You can edit a channel name only. You cannot edit a shaded item.

You can edit a channel

Channel Name	Measurement Device Name	Data Type	Channel Address
KM50-E#1#	KM50-E#1	Voltage	1
KM20#3#11 current (instantaneous)	KM20#3	Electric current	6
KM100#5#R-phase voltage	KM100#5	Voltage	7
D6FZ-FGX21#192.168.0.20#Insta...	D6FZ-FGX21#192.168.0.20	Standard flow rate	3
1FKM100_1#Electric energy	1FKM100_1	Electric energy	1
1FKM100_2#Electric energy	1FKM100_2	Electric energy	2
ZN-PD03-S#192.168.0.10#	ZN-PD03-S#192.168.0.10	0.3 micro-m parti...	3
ZN-PD03-S#192.168.0.10#	ZN-PD03-S#192.168.0.10	0.5 micro-m parti...	4
D6FZ-FGX21#192.168.0.20#	D6FZ-FGX21#192.168.0.20	Integrated flow r...	5
E50C#1#Temperature	E50C#1	Temperature	6
KM-N1#1#Active electric energy	KM-N1#1	Electric energy	7
EQ100 PULSE##PULSE	EQ100 PULSE#	Pulse	8
KM100#1#Electric energy	KM100#1	Electric energy	9
KM50-E#1#Total integral energy	KM50-E#1	Electric energy	10
ZN-PD03-S#192.168.0.10#	ZN-PD03-S#192.168.0.10	1.0 micro-m parti...	11
1FKM100_1#R-phase voltage	1FKM100_1	Voltage	12
1FKM100_1#T-phase voltage	1FKM100_1	Voltage	13

- 3) Click [OK].

■ Enabling/Disabling Logging

You can stop logging from a measurement device while keeping the channel registration as it is.

- 1) In the [Channel Registration] screen, change the setting of enabling/disabling [Logging].

Select	No.	Channel Name	Measurement Device Name	Channel Address	Data Type	Logging	Edit
<input type="checkbox"/>	1	ZN-KMX21#192.168.0.20#Electric...	ZN-KMX21#192.168.0.20	1-2	Electric energy	En	Edit
<input type="checkbox"/>	2	KM50-E#1#Total integral energy	KM50-E#1	C8-000C	Electric energy	En (Dis)	Edit
<input type="checkbox"/>	3	EQ100 PULSE##PULSE	EQ100 PULSE#		Pulse	En	Edit

Setting Item	Description
Logging	En (Enable): Logging from the channel is available. Dis (Disable): Logging is not done from the channel even if the logging is started.

7.4.5 Operation Channel Setting

■Function

In the operation channel setting, you can create a virtual measurement channel through an operation based on actual measurement channels.

There are two types of operation channels; a free operation channel and a basic unit operation channel (basic unit channel).

Precautions

- If there is no proper unit for data type (e.g. unit) of an operation channel, you need to create a data type beforehand. Refer to "7.4.6 Creating/Editing Data Type".

■Free Operation Channel

Free arithmetic and logic operations are available.

The following expressions can be created:

- Operation using 1 to 32 channels
- An operation result can be -9999999999 (10 digits) as the minimum to 9999999999 (10 digits) as the maximum, up to 5 decimal places

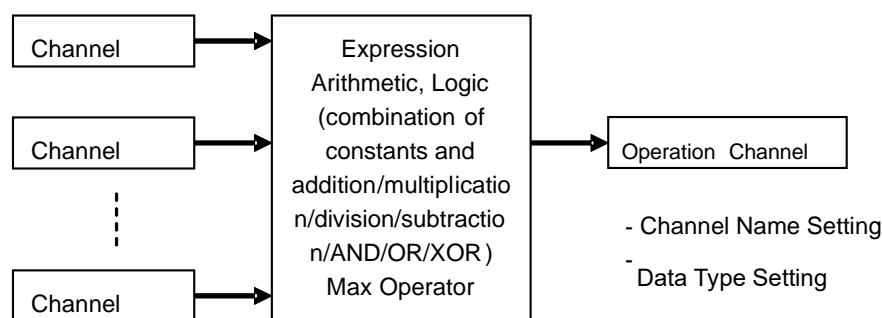

Input: Up to 32 channels

* Input is not available for operation channel

This function can be used if you want to use the following values:

e.g.)

- Sum value of electric energy consumption, etc, and differential value
- Compressor efficiency (discharge flow rate/electric energy consumption)
- Relation value of particle quantity and electric energy consumption
- CO₂ corresponding value (electric energy consumption x coefficient), etc

Precautions for Correct Use

- The system collects all the channel data in the 8-byte signed real, but when logic operation is specified, the system performs logic operation of the binary bit, with the target data regarded as an integer.
- If a communication error occurred in a measurement channel which is a part of the operation channel expression, the operation channel causes an error as well. The CSV file records it as shown below.

System internal file:

If a communication error occurred in a measurement channel which is a part of the operation channel expression, the operation is not established and the operation channel causes an error as well.

User-specified file/file acquired by Web UI data acquisition:

If a measurement channel which is a part of the operation channel expression is a blank due to a communication error, the operation channel becomes a blank as well.

■ Basic Unit Channel

Basic unit operation is available.

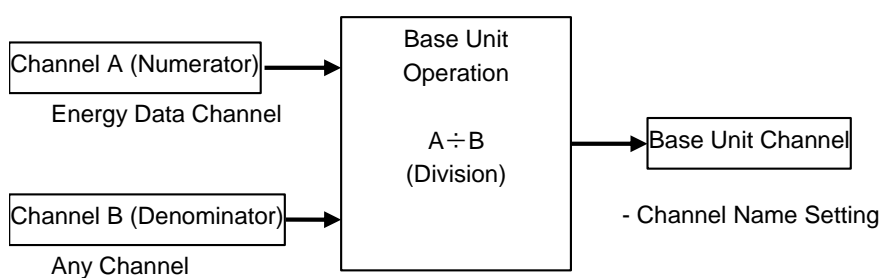

This function can be used if you want to use the following values:

e.g.)

- Electric energy consumption per production volume

Precautions for Correct Use

- An operation channel cannot be created by using channels with different collecting cycle,
- Measurement channels that configure one expression must be instantaneous values for both or integrated values for both only. Proper operation of an operation channel cannot be ensured that is configured by an expression with an instantaneous value and an integrated value.

■ Creating Free Operation Channel

1) In the setting menu, click [Operation Channel Setting].

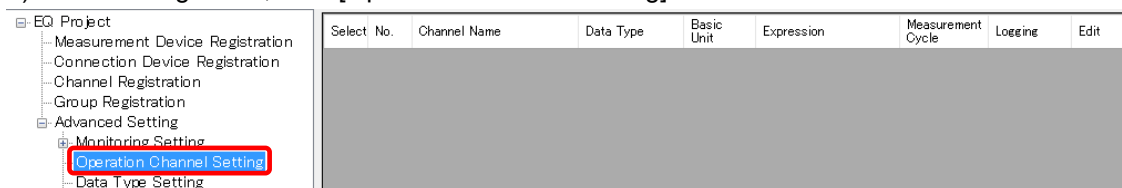

2) Click [Add].

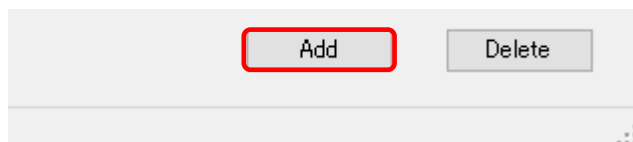

3) In the [Create Operation Channel] dialog box, click the [Free Operation Channel] tab.

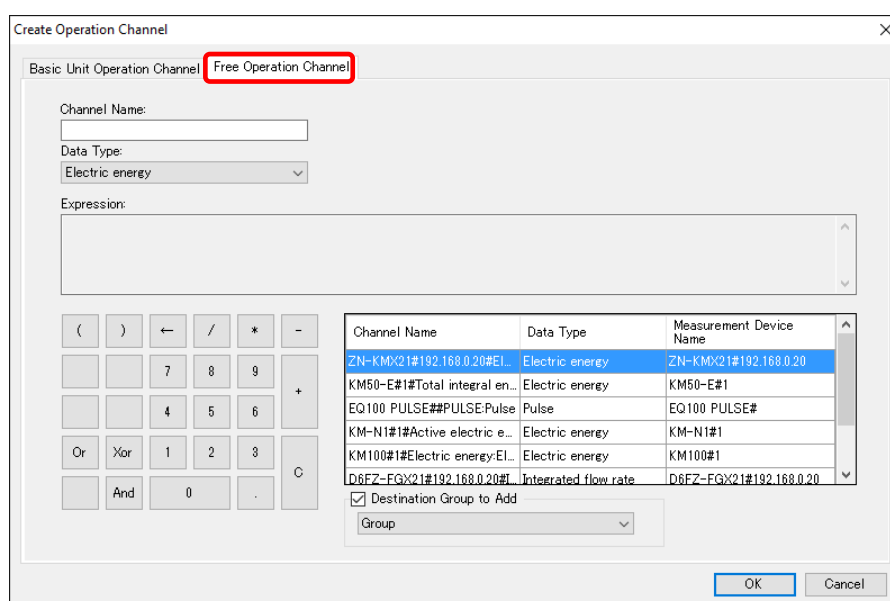

Item	Description
Channel Name	Enter a name of a new operation channel to create. <Input range> Half-width63 characters (Full-width 20 characters, more or less)
Data Type	Select a data type for the free operation channel.
Expression	Configure an operation expression by button input. <Input range> Character string in expression format: Half-width 199 characters Number of measurement channels that can be registered to an expression: 1 to 32 channels Measurement channels that configure one expression must be instantaneous values for both or integrated values for both only. Proper operation of an operation channel cannot be ensured that is configured by an expression with an instantaneous value and an integrated value.
Destination Group to Add	Select a group to which the created operation channel is added.

4) Enter a channel name.

5) Select a data type.

6) Create an expression.

To add to the expression, double-click a channel name or click an operation button.

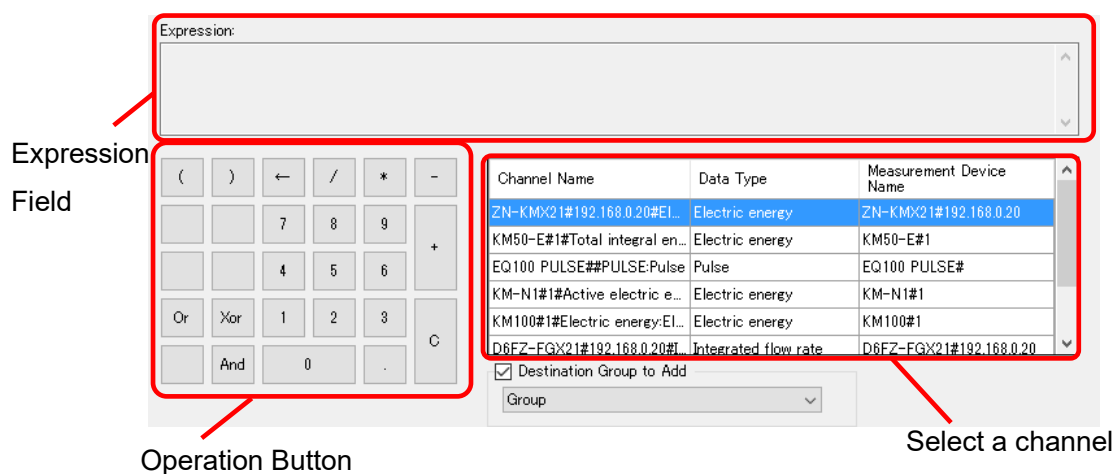

Item	Description
Expression	An expression appears.
()	A parenthesis is entered to the operation expression.
←	An operator or a channel is deleted.
/ * - +	Arithmetic operation is done.
And,Or,Xor	Logic operation of binary bits is done.
.	A decimal point is entered to the operation expression.
C	Entire operation expression is deleted.
Channel Name, Data Type, Measurement Device Name	Added to the expression by double-clicking.

7) Select a group to which the created operation channel is added.

8) Click [OK].

● Setting Example of Operation Channel (Creating Free Operation Channel from EQ100 General-Purpose Input)

The number of pulses from the EQ100 input terminal is counted and a pulse input count channel is automatically generated. A free operation channel created based on the count can convert units to engineering units (e.g. energy data) such as flow rate and electric energy.

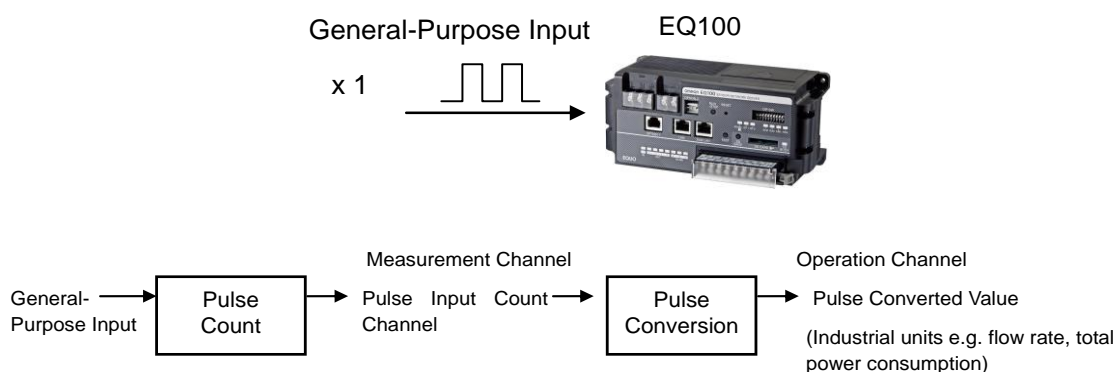

In this case, the following conversion is performed:

Conversion: $\text{Converted value} = A \times \text{Pulse input count}$

A: Weight per 1 pulse (coefficient)

After the decimal point: Specify the number of digits after the decimal point of the value after conversion.

Unit: User-specified unit (Set by creating the data type)

e.g.) For electric power of 10 kWh per 1 pulse

Unit: kWh

Coefficient: 10 (/pulse)

Reference

- Pulse input count from a measurement device e.g. the KM series can be converted by an operation expression as with EQ100 pulse input count.

Reference

- Electric energy converted from the pulse input count based on the EQ100 conversion setting can be displayed as a graph on the Web UI screen and EQ-GraphViewer.

■ Creating Basic Unit Operation Channel

1) In the setting menu, click [Operation Channel Setting].

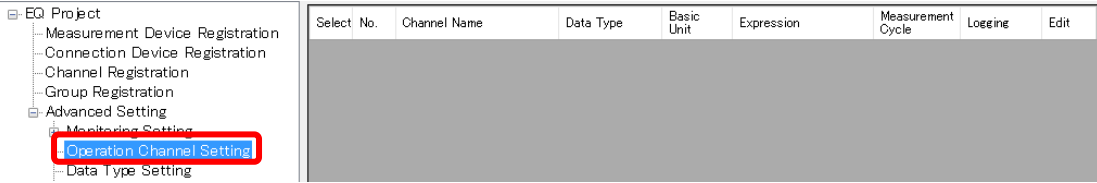

2) Click [Add].

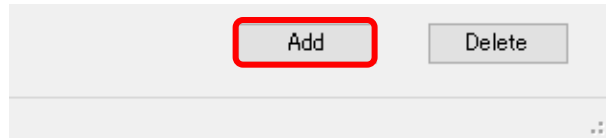

3) In the [Create Operation Channel] dialog box, click the [Basic Unit Operation Channel] tab and configure the settings.

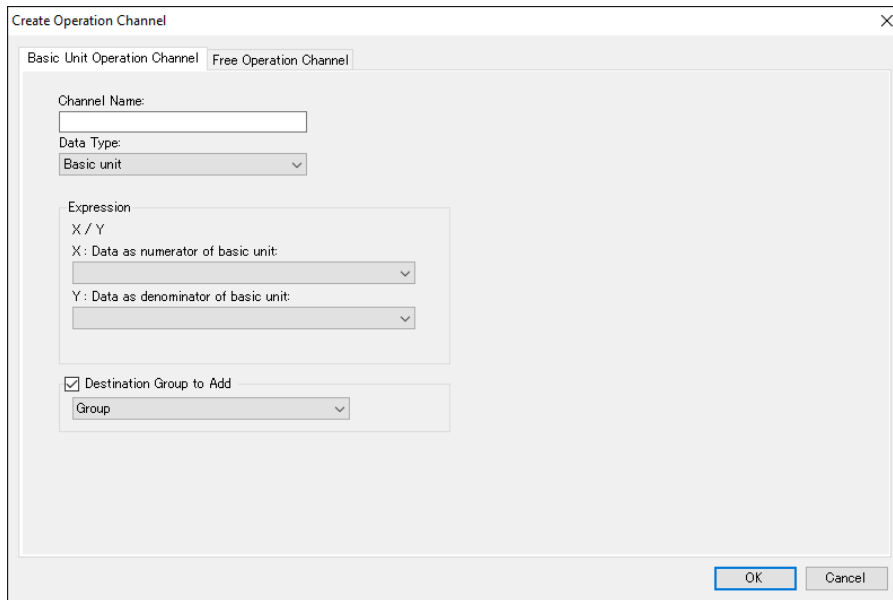

Setting Item	Description
Channel Name	Enter a name of a new basic unit operation channel to create. <Input range> Half-width63 characters (Full-width 20 characters, more or less)
Data Type	Select a data type for the basic unit operation channel.
Data as numerator of basic unit	Select an existing channel as a numerator of the basic unit operation channel. Measurement channels that configure a denominator and a numerator must be instantaneous values for both or integrated values for both only.
Data as denominator of basic unit	Select an existing channel as a denominator of the basic unit operation channel. Measurement channels that configure a denominator and a numerator must be instantaneous values for both or integrated values for both only.
Destination Group to Add	Select a group to which the created basic unit operation channel is added.

4) Click [OK].

■ Editing Operation Channel

1) Click the [Edit] button of the expression you want to change.



2) In the [Create Operation Channel] dialog box, edit the details.

You cannot edit Destination Group to Add. To edit a group, refer to "8.1.7.4.7. Group Registration".

3) Clicking [OK] changes the operation channel.

■ Deleting Operation Channel

Select the [Select] check box of the channel you want to delete, and click [Delete].

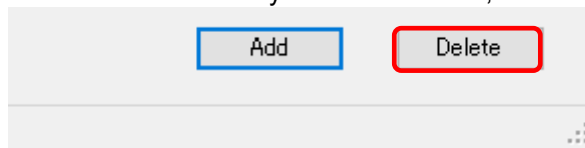

The channel is deleted from the registered channels.

7.4.6 Creating/Editing Data Type

■ Function

A category of data that defines a unit of data, summary method, or discrimination of integral and instantaneous values.

The data types are provided by the system. You can create a category not defined by the system.

In the data type setting, specify data type name, unit, decimal places, and energy data.

For system-defined data types, you can change unit, decimal places, and energy data.

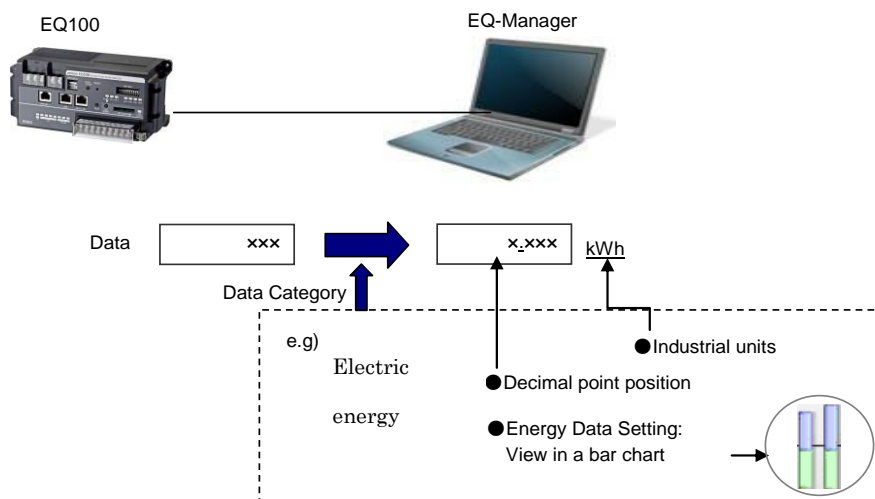

Reference

- For system-defined data types, see "Graph Viewer Tool EQ-Viewer User's Manual (N198-E1-01)".

■ Adding Data Type

To add a new data type:

1) In the setting menu, click [Data Type Setting].

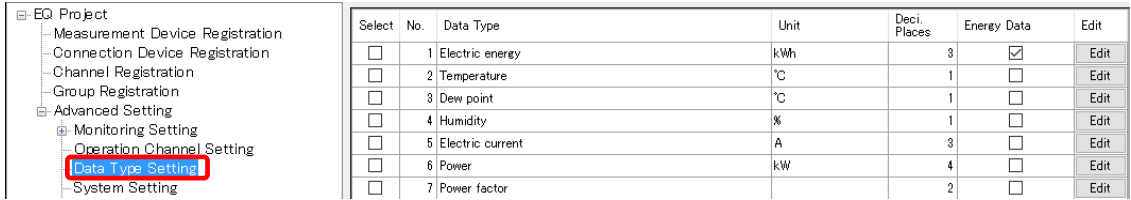

2) Click [Add] on the bottom right of the screen.

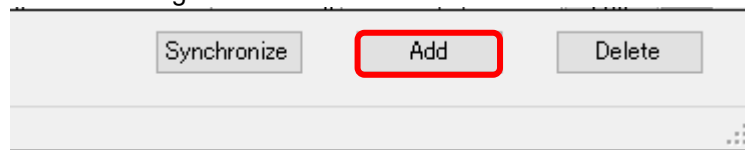

3) In the [Data Type Setting] dialog box, enter the details.

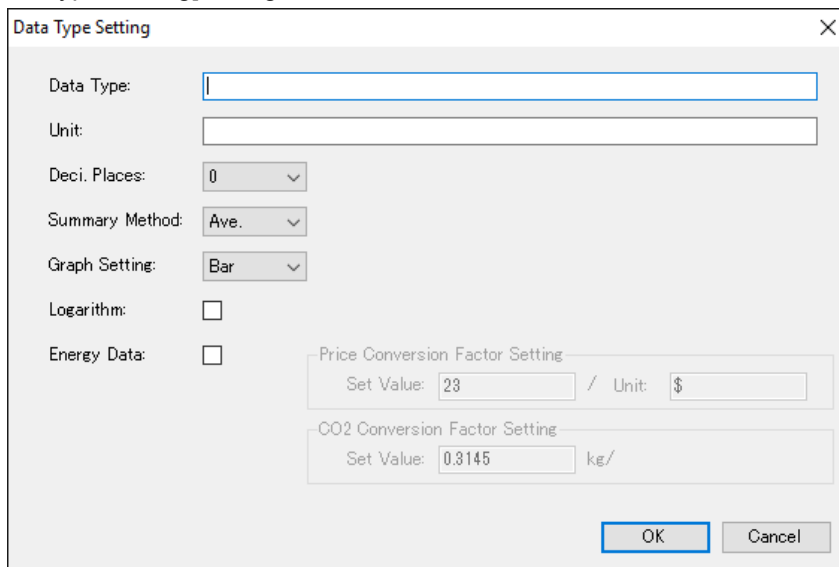

Setting Item	Description
Data Type	Enter a data type. <Input range> Half-width63 characters (Full-width 20 characters, more or less)
Unit	Enter a unit of the data type. <Input range> Half-width 9 characters (Full-width 3 characters, more or less)
Deci. Places	Select the number of decimal places. <Selection> 0 to 9 digits
Summary Method	Select a data type from average, sum, minimum, or maximum.
Energy Data	A bar graph is displayed on Web UI.

4) Click [OK].

■ Editing Data Type

To edit a data type:

1) Click the [Edit] button of the data type you want to change. In the [Data Type Setting] dialog box, change the settings.

<input type="checkbox"/>	38	Basic unit	kWh/	3	<input type="checkbox"/>	Edit
--------------------------	----	------------	------	---	--------------------------	------

2) Click [OK].

7.4.7 Group Registration

■ Function

You can register a channel to a channel group.

A channel must be registered to a channel group.

The registered group is used for a graph view on the Web UI screen of EQ100.

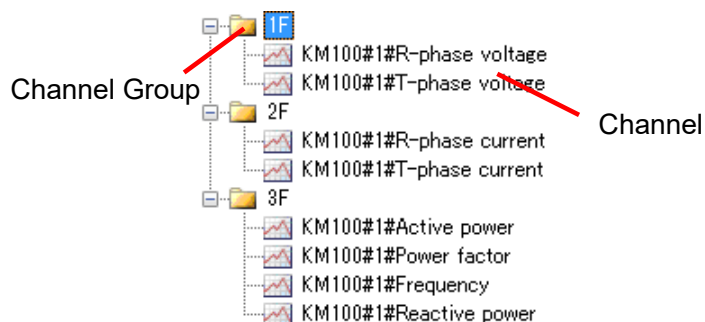





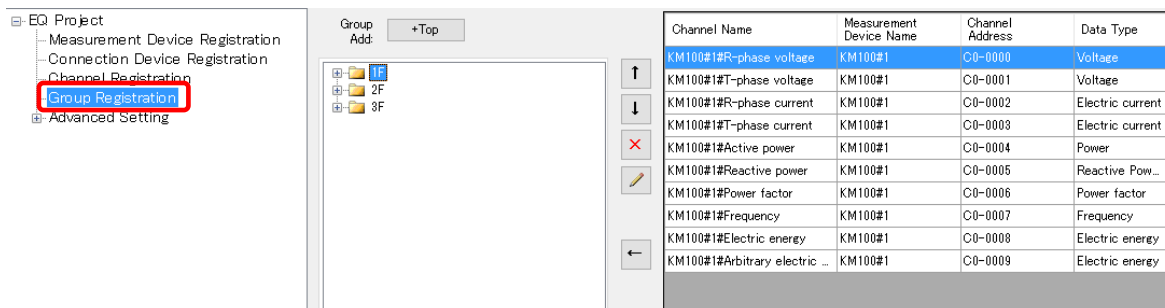

Icon	Description
	Indicates a channel group.
	Indicates a channel.

■ Viewing Registration Screen

In the setting menu, click [Group Registration].



Shown below are button functions:

Button	Description
	Creates a channel group.
	Moves the selected channel group up by one.
	Moves the selected channel group down by one.
	If a channel is being selected, the channel is deleted from the registered group. If a channel group is being selected, the group or a part of the channels in the group is deleted.
	Changes the selected channel group name.
	Adds the channel selected in the channel list on the right to the channel group.

■ Adding Channel Group

1) To add a channel group, Click [+Top].



2) In the [Add Group] dialog box, enter a channel group name.

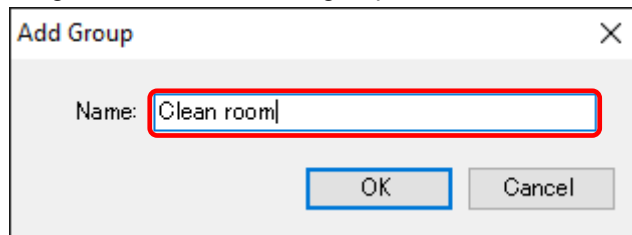

Setting Item	Description
Name	Enter a channel group name. <Input range> Half-width63 characters (Full-width 20 characters, more or less) <Maximum Group Count> Up to 20 groups

3) Clicking [OK] adds the channel group.

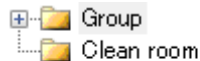

■ Adding Channels

To add a channel to a channel group:

- 1) Select a channel group to add. In this example, click [1st Building 3rd floor].

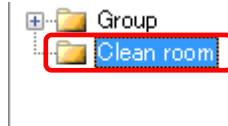

- 2) Add a channel to the channel group.

(1) Select a channel to add. You can select:

- One channel: By clicking the channel line.
- Multiple serial channels: By pressing and holding a [Shift] key while clicking the first and the last channel lines.
- Multiple independent channels: By pressing and holding a [Ctrl] key while clicking.

(2) Click the [-] button.

Channel Name	Measurement Device Name	Channel Address	Data Type
WZ-SCD01#1#CO2 Co...	WZ-SCD01#1	1	CO2 Concentr...
KM50-E#1#Voltage 1 (...)	KM50-E#1	C8-0000	Voltage
KM50-E#1#Voltage 2 (...)	KM50-E#1	C8-0001	Voltage
D6FZ-FGX21#192.168...	D6FZ-FGX21#192.1...	1-1	Integrated flo...
D6FZ-FGX21#192.168...	D6FZ-FGX21#192.1...	1-2	Standard flow...
D6FZ-FGX21#192.168...	D6FZ-FGX21#192.1...	1-5	Volume flow r...
KM20#3#P1-P2 voltag...	KM20#3	C0-0000	Voltage
KM20#3#I1 current (ins...	KM20#3	C0-0002	Electric current
KM20#3#I2 current (ins...	KM20#3	C0-0003	Electric current
KM100#5#R-phase vol...	KM100#5	C0-0000	Voltage
KM100#5#T-phase vol...	KM100#5	C0-0001	Voltage
KM100#5#R-phase cur...	KM100#5	C0-0002	Electric current

- 3) The selected channel(s) are added to the channel group [1st Building 3rd floor].

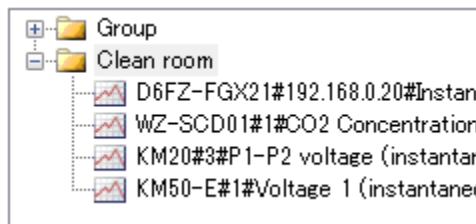

■ Deleting Channel Group

- 1) Select a channel group you want to delete, and click the [x] button.

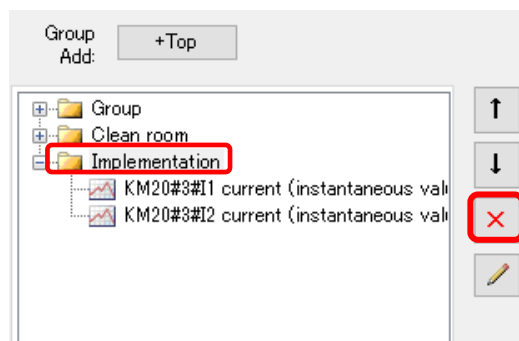

2) Select [Delete Group], and click [OK].

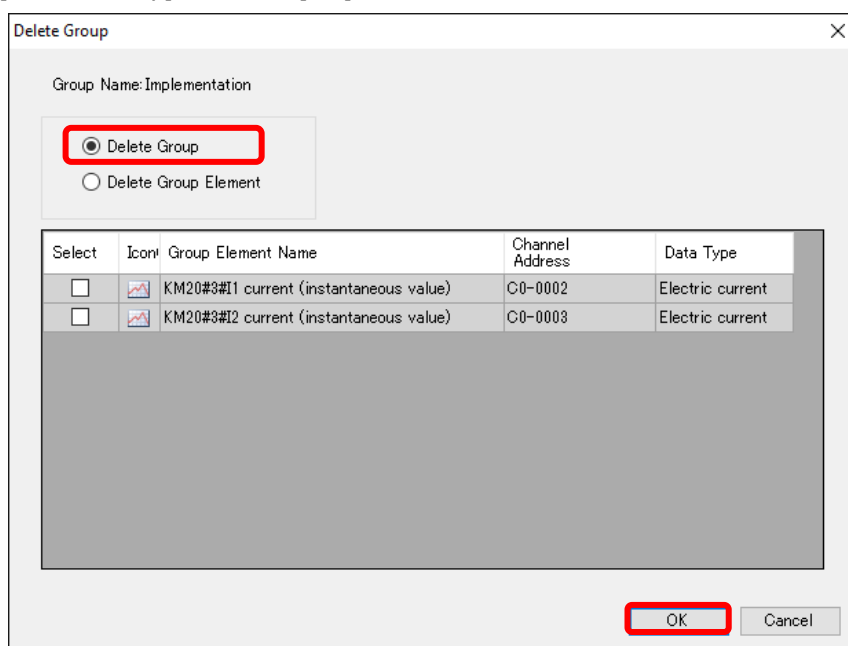

3) The selected group and the channels belonging to the group are deleted.

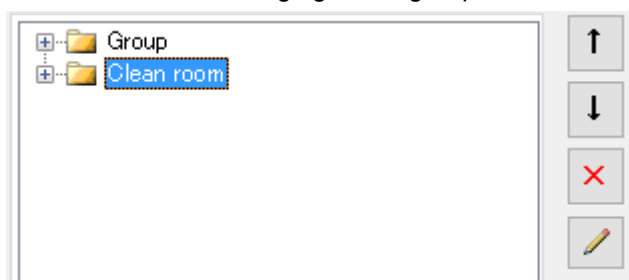

Precautions for Correct Use

- You cannot delete a channel group if it is the only channel group.

■ Partially Deleting Channels in Channel Group

* You can delete channels using the Delete Channel Group screen.

1) Select a group that contains the channels you want to delete, and click the [x] button.

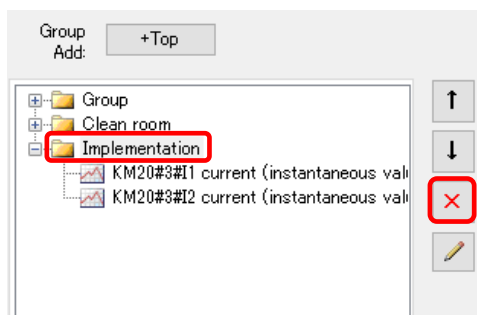

2) Select [Delete Group Element] and the check boxes of the channels you want to delete, and click [OK].

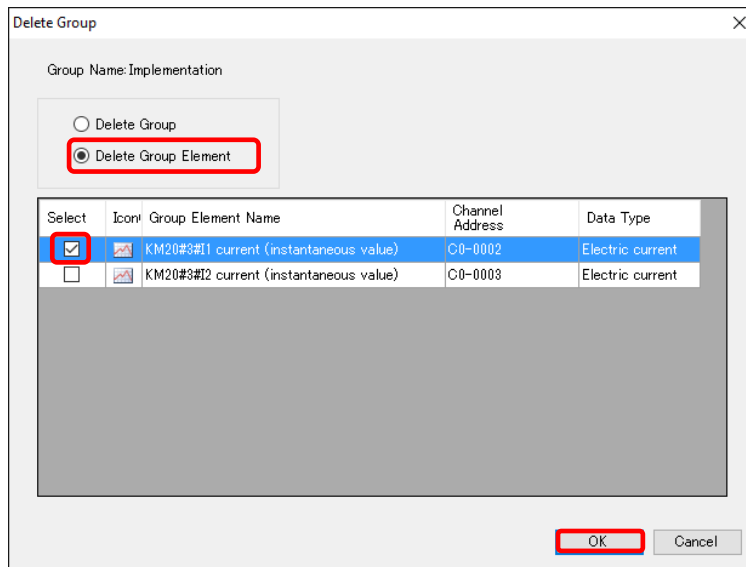

3) The selected channels are deleted.

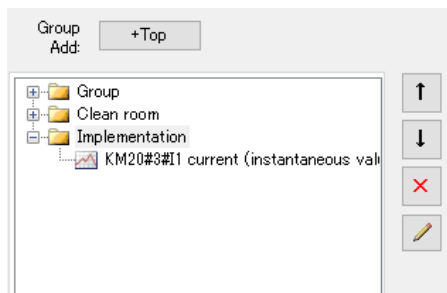

■Deleting Channel

1) Select channels you want to delete, and click the [x] button.

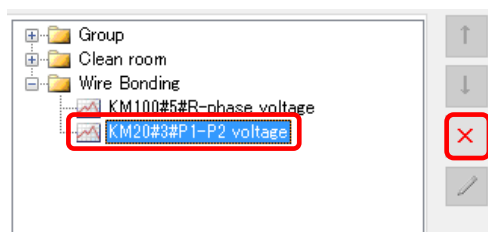

2) The selected channels are deleted.

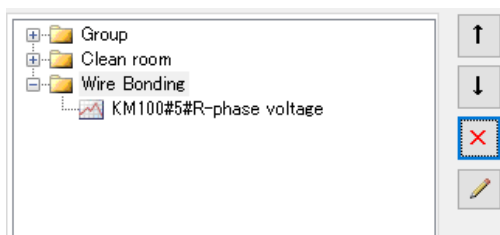

7.5 EQ100 Monitoring Setting

7.5.1 Overview

The monitoring settings include the following functions. Configure the setting if necessary.

Monitoring Setting	Description
Monitoring Alarm	Occurs when a measured value exceeds the configured control value.
Device Alarm	Occurs when a device error is detected. For device alarm, see "12.1.2. Event Log Code List".
Periodic Report	Sends email regularly to check EQ100 operations.

7.5.2 Monitoring Alarm

For this function, configure the upper and lower limits of the control values for each channel collected by EQ100 and the number of times over the control values to occur an alarm. If a measured data exceeds the setting, an email is sent or output is made to a general-purpose output terminal. An email can be sent on a destination group and/or a time slot basis.

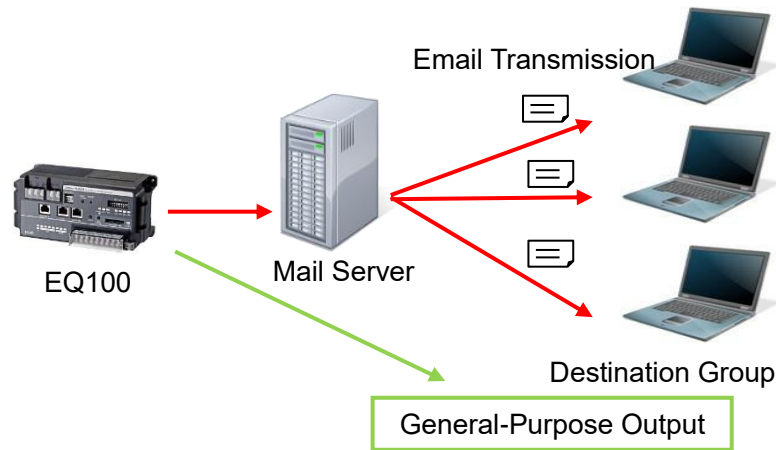

■ Setup Flow

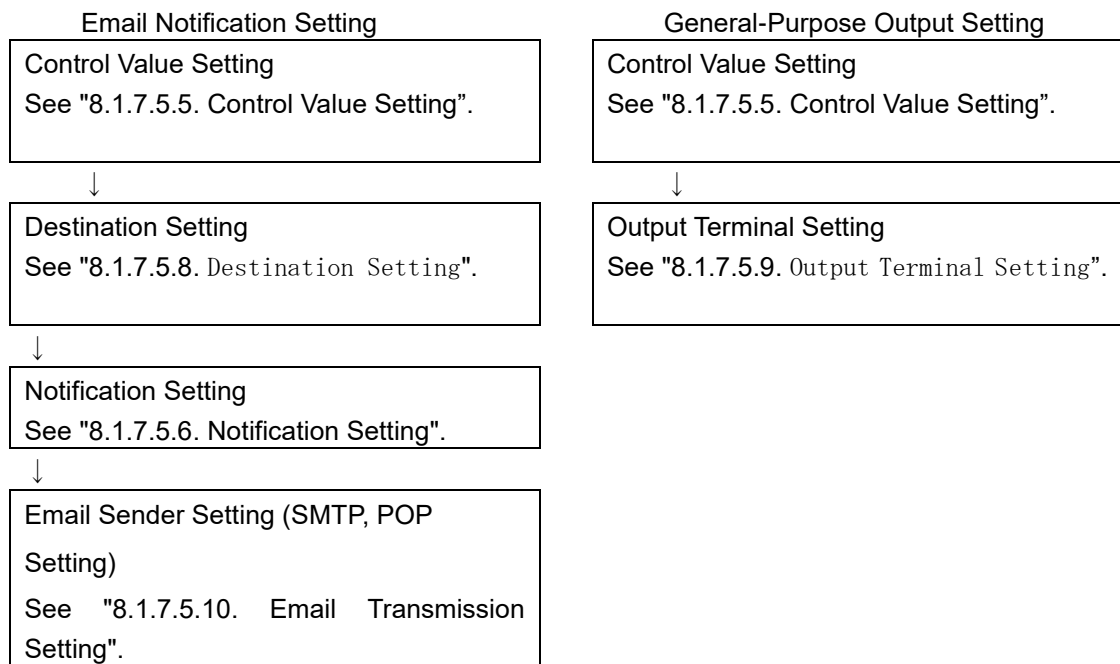

7.5.3 Device Alarm

Occurs when a device error is detected.

For device alarm, see "12.1.2. Event Log Code List".

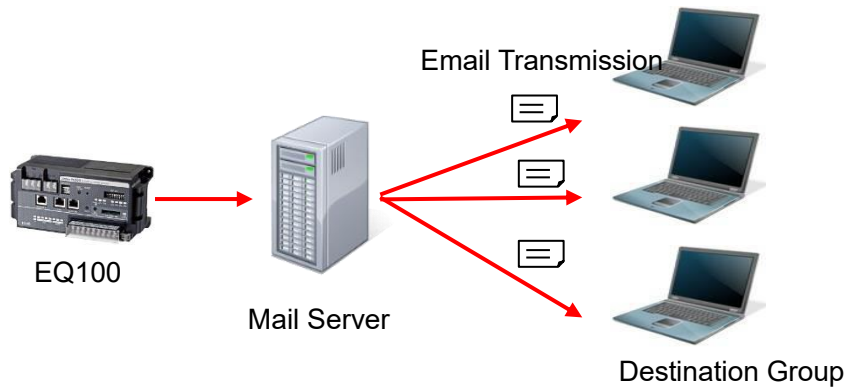

■ Setup Flow

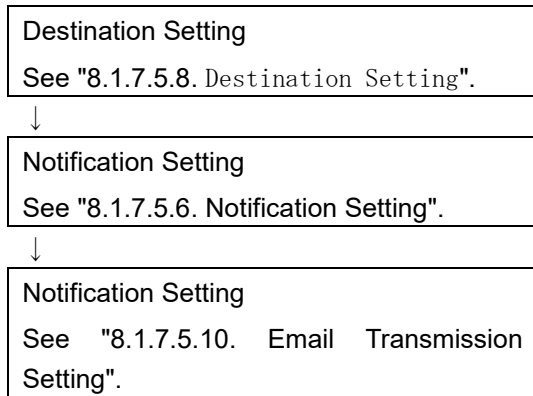

7.5.4 Periodic Report

Sends email regularly to check EQ100 operations.

Registered details are sent as an email.

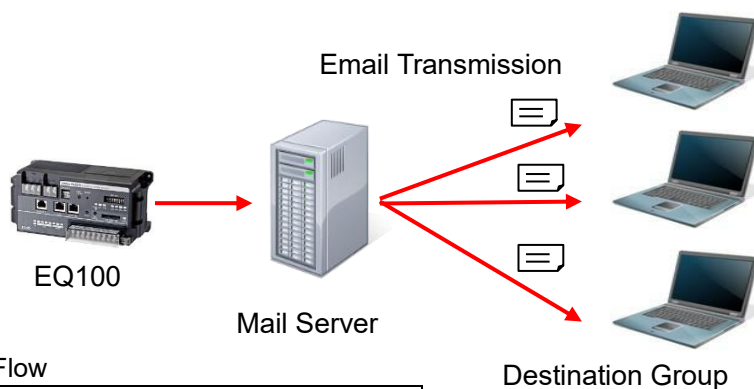

■ Setup Flow

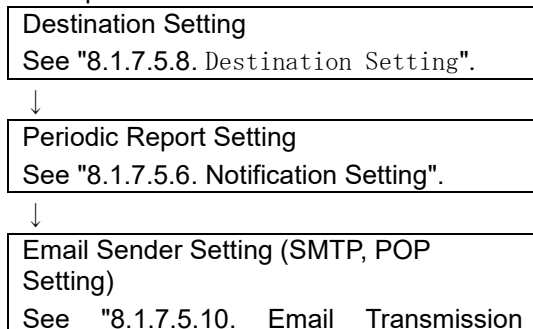

Setting".

7.5.5 Control Value Setting

■Function

Specify the upper and lower threshold values for each channel collected by EQ100. In addition, specify the number of times over the threshold values to evaluate an occurrence of monitoring alarm.

If a measured data exceeds the setting, an email is sent ("8.1.7.5.8. Destination Setting") or output is made to a general-purpose output ("8.1.7.5.9. Output Terminal Setting").

■Control Value Setting

1) In the setting menu, click [Control Value Setting].

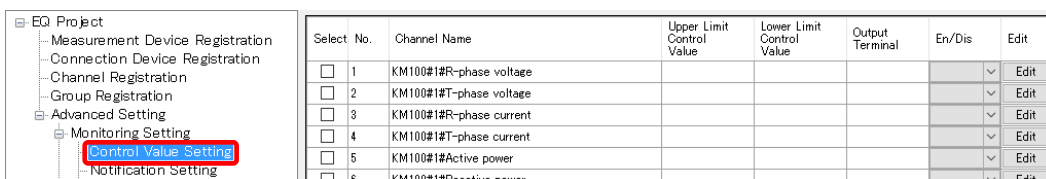

2) Click the [Edit] button of the channel you want to configure.

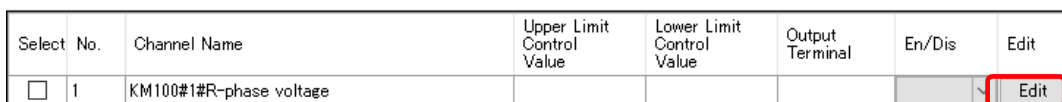

3) In the [Control Value Setting] dialog box, enter the details.

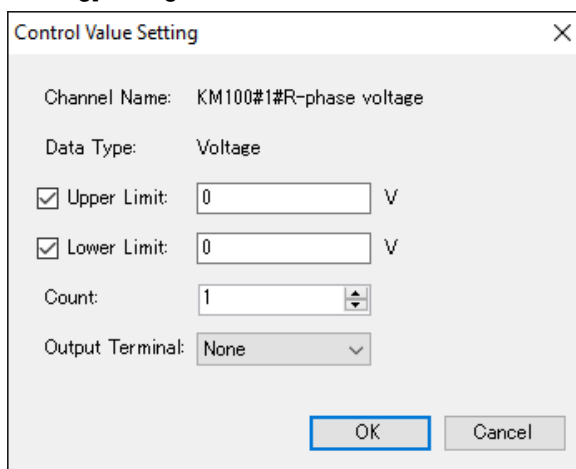

Setting Item	Description
Upper Limit check box	Select this check box if you want to enable the upper limit control value.
Upper Limit	Specify the upper limit control value.
Lower Limit check box	Select this check box if you want to enable the lower limit control value.
Lower Limit	Specify the lower limit control value.
Count	Specify the number of times over the control values to occur a monitoring alarm. <Selection> 1 to 8 times
Output Terminal	Set an EQ100 general-purpose output terminal number. If "None" is set, no output is made to the output terminals. To make an output to an output terminal, you must configure the output terminal setting in "8.1.7.5.9. Output Terminal Setting". for the selected output terminal number. <Selection> None/1/2/3/4

4) Click [OK].

■Deleting Control Value

Select the [Select] check box of the channel you want to delete, and click [Delete].



The control value setting is deleted.

Reference

- You can configure in on the Web UI screen as well. For details, see "9.4. Monitoring Screen".

7.5.6 Notification Setting

■Function

For notification setting, select an email destination group for the following two notification emails.

Before configuring periodic report setting, you must configure the destination group setting (see "8.1.7.5.8. Destination Setting").

Item	Transmission Condition
Monitoring Alarm	A measured data is over the upper or under the lower limit of the control value setting.
Device Alarm	An instrument failure, setup/status, device, communications, and/or monitoring process of EQ100 occurred.

■Editing Destination Group

1) In the setting menu, click [Notification Setting].

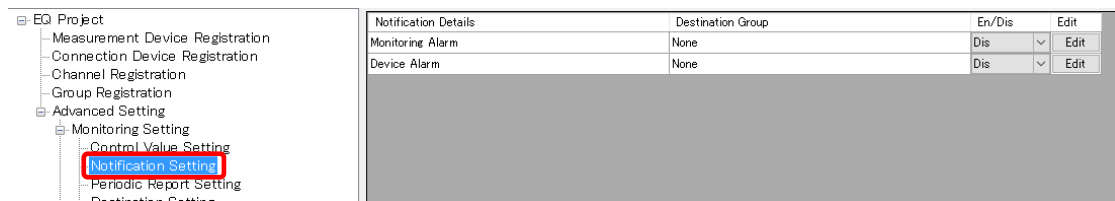

2) Set [En] for the [En/Dis] (Enable/Disable) of monitoring alarm or device alarm, and click the [Edit] button.

Notification Details	Destination Group	En/Dis	Edit
Monitoring Alarm	None	Dis	Edit
Device Alarm	None	Dis	Edit

3) In the [Notification Setting] dialog box, select a destination group.

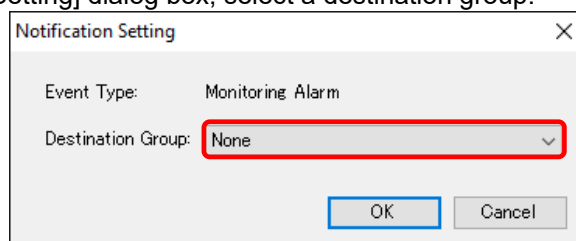

4) Click [OK].

7.5.7 Periodic Report Setting

■Function

An email notifies EQ100 operations.

Registered details are sent as an email to a destination group periodically.

Before configuring periodic report setting, you must configure the destination group setting (see "8.1.7.5.8. Destination Setting").

Precautions for Correct Use

- If the transmission condition of periodic report is out of the transmission schedule in the [Destination Setting], the periodic report is not done.

■Editing Periodic Report Setting

1) In the setting menu, click [Periodic Report Setting].



2) Click [Edit].

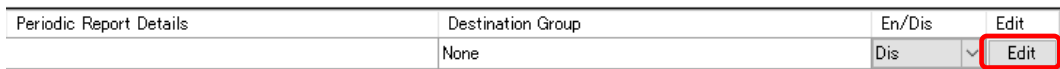

3) In the [Periodic Report Setting] dialog box, enter the details.

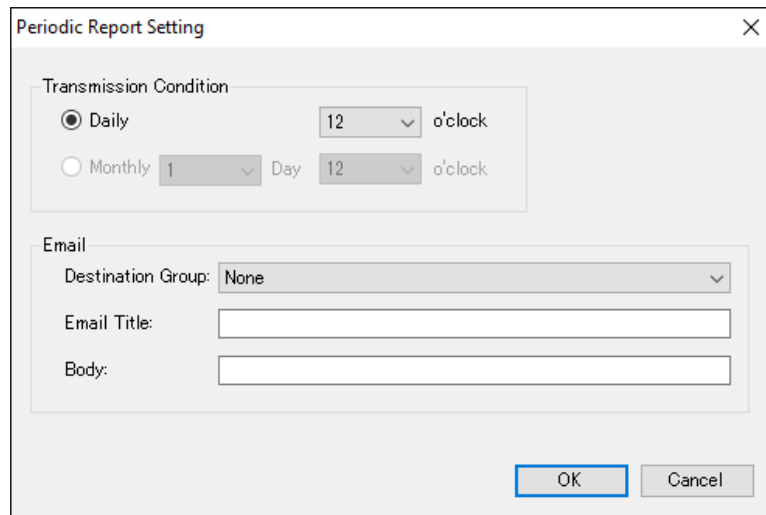

Setting Item	Description
Transmission Condition	Select a transmission hour of periodic report email. <Setup Range> 0 to 23 o'clock
Email	Select a destination group and enter the title and body of the mail. <Input range> Email Title: Half-width 63 characters (Full-width 20 characters, more or less) Body: Half-width 499 characters (Full-width 160 characters, more or less)

4) Click [OK].

7.5.8 Destination Setting

■Function

Specify a destination group and email address of [Notification Setting] and [Periodic Report Setting].

Up to four groups and up to 10 emails per group can be configured.

Specify a transmission schedule and email address as a set. The transmission schedule must be specified in a day of the week and a time slot. You can specify more than one transmission schedule.

Destination 1	Transmission Schedule 1	Email Addresses 1 to 10
	Transmission Schedule 2	Email Addresses 1 to 10
	Transmission Schedule 3	Email Addresses 1 to 10
		•
		•
		•
Destination 2	Transmission Schedule 1	Email Addresses 1 to 10
	Transmission Schedule 2	Email Addresses 1 to 10
		•
		•
Destination 4		

Precautions

- To send an email to a destination group, email transmission setting is required. For details, see "8.1.7.5.10. Email Transmission Setting"

■Editing Destination

1) In the setting menu, click [Destination Setting].

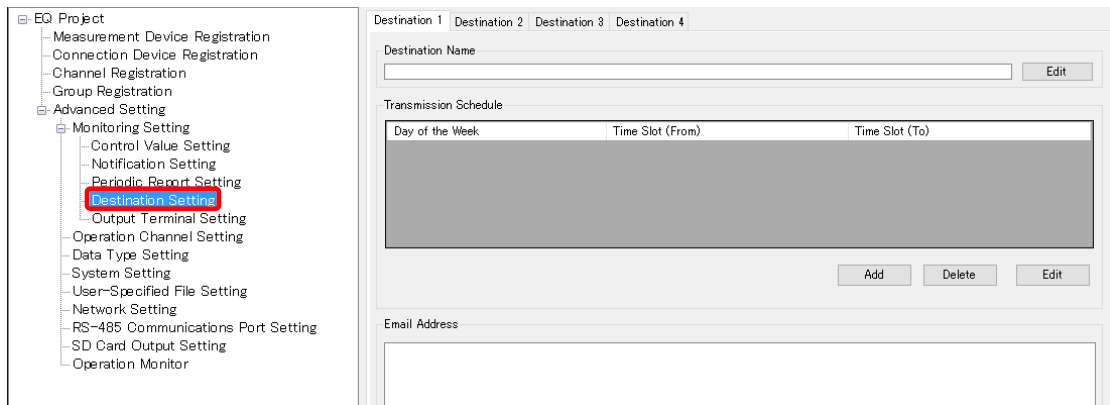

2) Select a destination to edit.

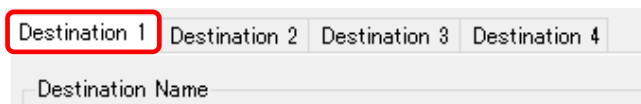

3) Click [Edit].



4) In the [Edit Destination Name] dialog box, specify a destination name.

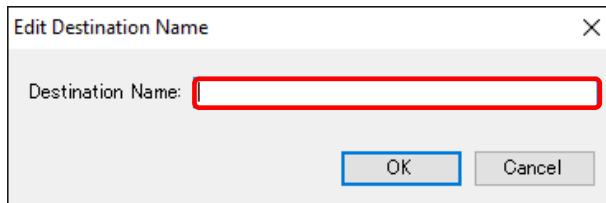

5) Click [OK].

■ Adding Transmission Schedule and Email Address

1) Select a destination (1 to 4) tab, and click the [Add] button.

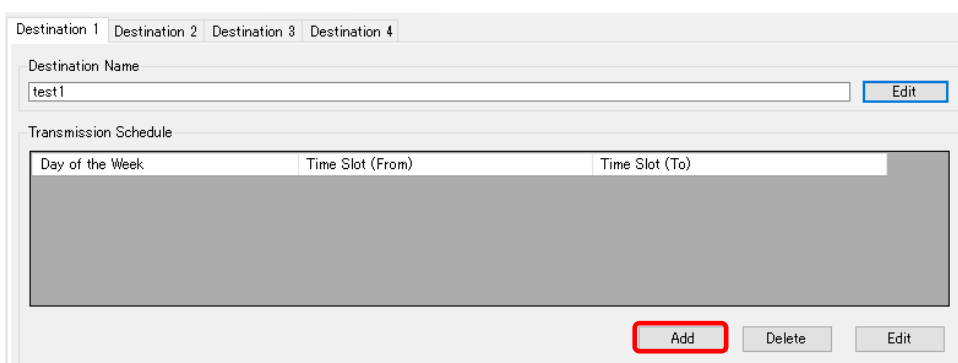

2) In the [Transmission Schedule] dialog box, enter the details.

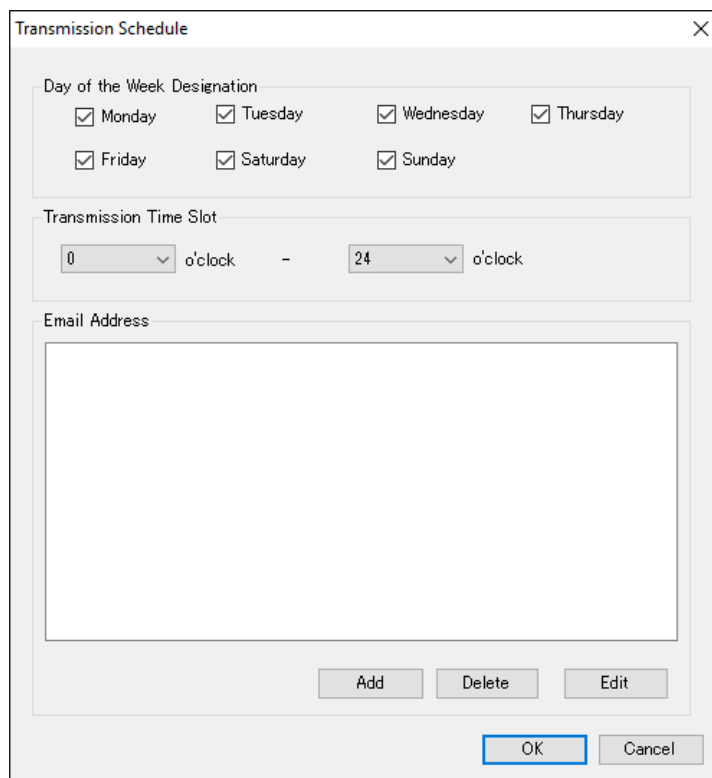

Setting Item	Description
Day of the Week Designation	Specify a day of the week to send. Select a check box for the day.
Transmission Time Slot	Select a time slot to send. Available start time of the time slot is from 0 to 23 o'clock, end time from 1 to 24 o'clock.
Email Address	Click a button to specify an email address. Up to 10 email addresses can be configured. Add: In the [Destination] dialog box, enter the email address. Edit: Select an email address and click the [Edit] button. In the [Destination] dialog box, change the setting. Delete: Select the email address and click [Delete].

3) Click [OK].

4) To add a transmission schedule, repeat the steps from 1) to 3).

■Editing Transmission Schedule and Email Address

1) Select a destination (1 to 4) tab.

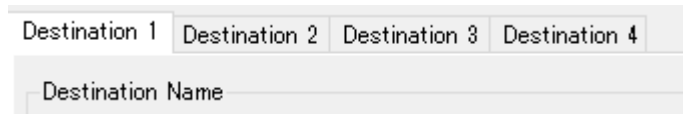

2) Select a transmission schedule to edit, and click [Edit].

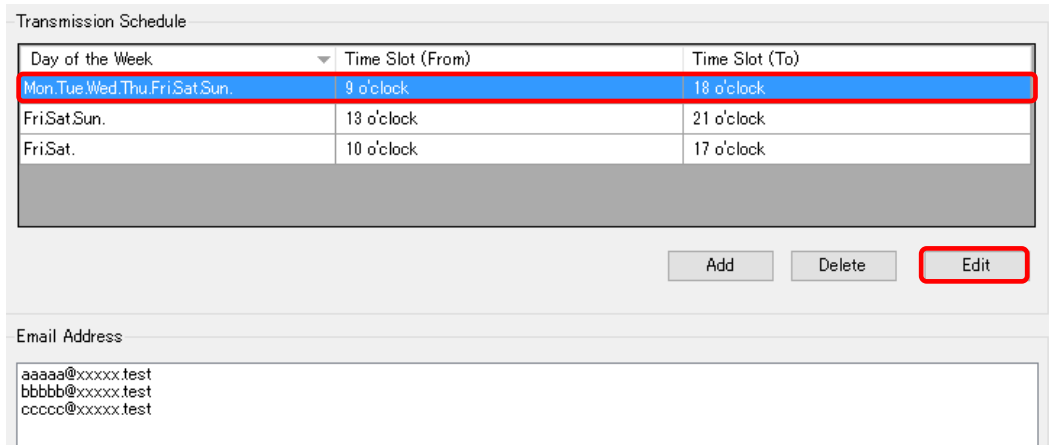

3) In the [Transmission Schedule] dialog box, change the transmission schedule or email address.

4) Click [OK].

■Deleting Transmission Schedule and Email Address

1) Select a destination (1 to 4) tab.

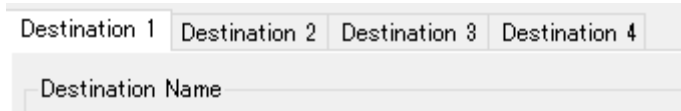

2) Select a transmission schedule to delete, and click [Delete].

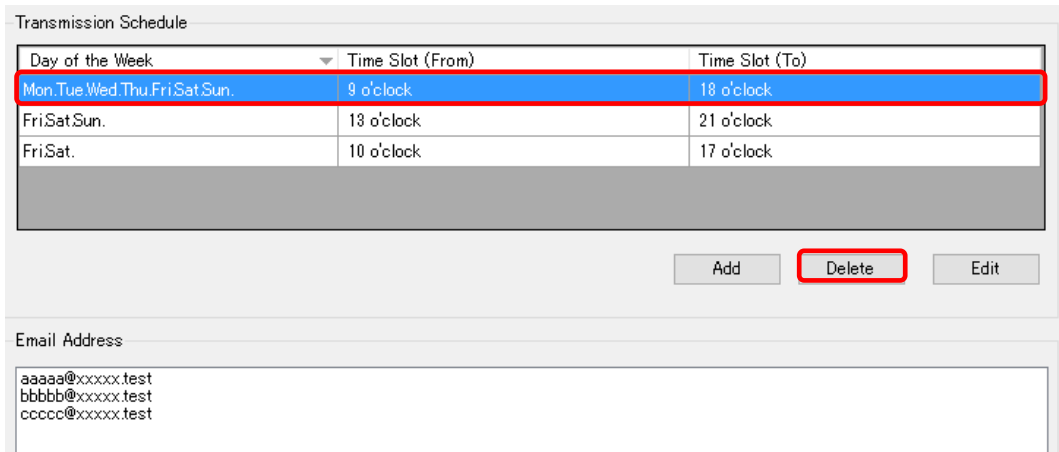

3) The selected transmission schedule and email address are deleted.

7.5.9 Output Terminal Setting

Configure operations of four output terminals specified in the control value setting.

For the output terminal setting, you can select either [On upon Event/Off upon Return] or [Off upon Event/On upon Return].

■Editing General-Purpose Output Setting

1) In the setting menu, click [Output Terminal Setting].

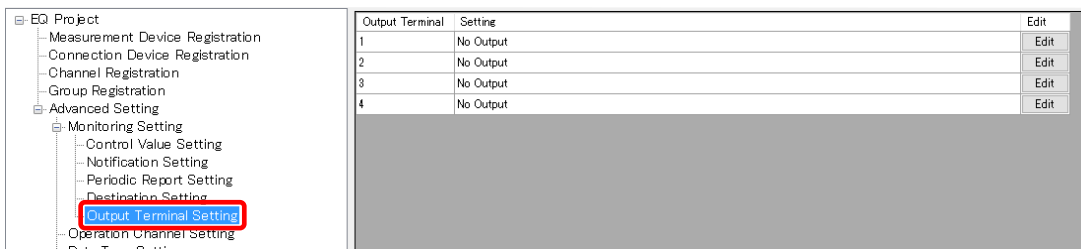

2) Click the [Edit] button of the general-purpose output terminal number you want to configure.

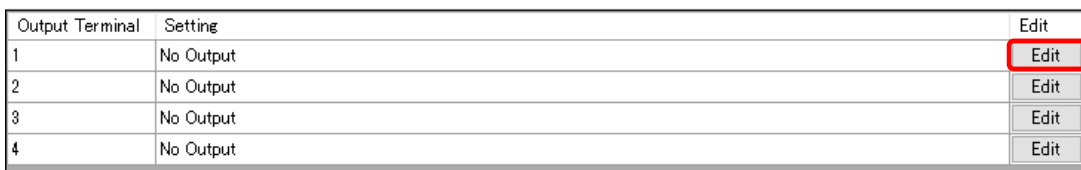

3) In the [Operation Setting] dialog box, select an operation setting.

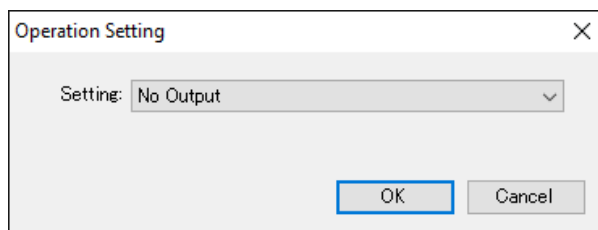

Item	Description
No output	No output is done.
On upon Event/Off upon Return	On if an output is specified in the control value setting, Off if returned.
Off upon Event/On upon Return	Off if an output is specified in the control value setting, On if returned.

4) Click [OK].

Precautions for Correct Use

- An output status of a general-purpose output changes only upon event occurrence/recovery of the EQ100 collecting status. A change of an operation status by stopping EQ100 collecting and returning to the setup status does not change the output status of a general-purpose output terminal.
 - * EQ100 of the firmware version 1.160 or later resets the output status when starting collection.
- Use the Web UI screen to operate a general-purpose output terminal status.
For details, see "9.10. Maintenance > Operation Check".

7.5.10 Email Transmission Setting

■ Function

Specify an email account of EQ100 (sender) to send in the notification setting and periodic report setting.

■ Setup Steps

1) In the setting menu, select [Network Setting] and click the [Email Transmission] tab.

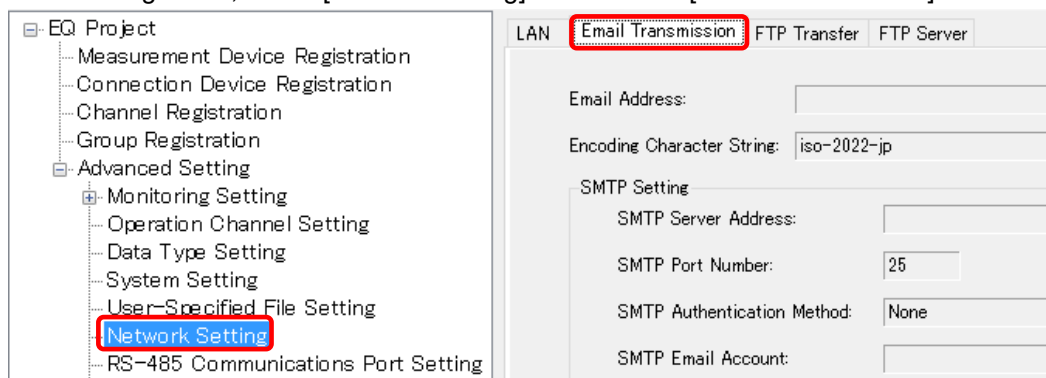

2) In the following screen, configure the following items.

The screenshot shows the Email Transmission configuration screen with the following fields and buttons:

- LAN | **Email Transmission** | FTP Transfer | FTP Server
- Email Address:
- Encoding Character String:
- SMTP Setting
 - SMTP Server Address:
 - SMTP Port Number:
 - SMTP Authentication Method:
 - SMTP Email Account:
 - SMTP Password:
 -
- POP Setting
 - POP Server Address:
 - POP Port Number:
 - POP Email Account:
 - POP Password:
 -

Clicking [Set] button shows a corresponding dialog box. Configure the setting if required.

Setting Item	Description
Email Address Encoding Character String	Set an EQ100 email address. Select an encoding character string as well. <Input Range> Half-width 63 characters
SMTP Setting	Enter SMTP settings. - SMTP Server Address <Input Range> Half-width 126 characters - SMTP Port Number <Initial Value> 25 - SMTP Authentication Method <Selection> None/SMTP authentication (PLAIN)/SMTP authentication (MD5)/POP before SMTP/APOP before SMTP - SMTP Email Account <Input Range> Half-width 63 characters - SMTP Password <Input Range> Half-width 63 characters
POP Setting	Specify this item if the SMTP server authentication is [POP before SMTP] or [APOP before SMTP]. For others, the setting is not required. Configure the following items: - POP Server Address <Input Range> Half-width 126 characters - POP Port Number <Initial Value> 110 - POP Email Account <Input Range> Half-width 63 characters - POP Password <Input Range> Half-width 63 characters

■ Available characters for password

Available characters for password in email transmission are shown below.

Blank	!	“	#	\$	%	&	‘	()	*	+	,	-	.	/
0	1	2	3	4	5	6	7	8	9	:	;	<	=	>	?
@	A	B	C	D	E	F	G	H	I	J	K	L	M	N	O
P	Q	R	S	T	U	V	W	X	Y	Z	[¥]	^	_
`	a	b	c	d	e	f	g	h	i	j	k	l	m	n	o
p	q	r	s	t	u	v	w	x	y	z	{		}	~	

7.5.11 Checking Email Transmission

■ Function

A user manually sends this email to check the notification email setting or communications setup with the SMTP server.

■ How to Send

On the Web UI screen, select [Maintenance] - [Operation Check]. In the [Email Transmission Setting], click the [Send] button. If the test mail is delivered to the destination as configured, the email transmission setting is successful. If not, review the email transmission setting.

7.6 EQ100 Settings

7.6.1 Overview

Configure the EQ100 settings.

7.6.2 Language/Time Zone Setting

■ Function

Specify a language type, date locale, and time zone.

■ Setup Steps

1) In the setting menu, click [System Setting].

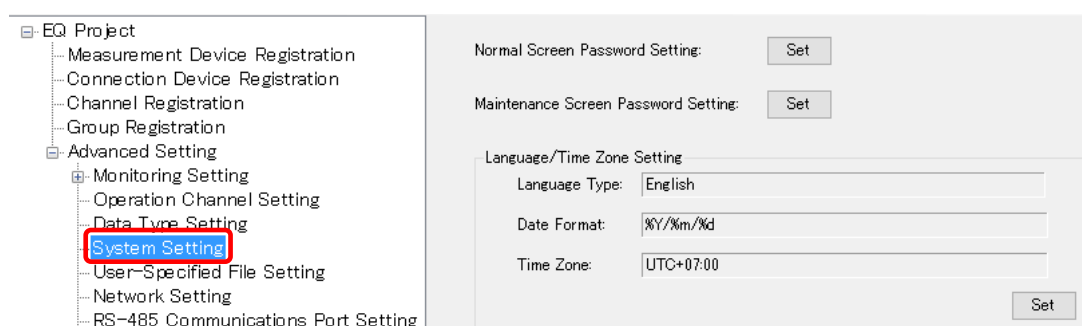

2) Clicking the [Set] button in [Language/Time Zone Setting] displays the [Language/Time Zone Setting] dialog box.

Select date locale and time zone.

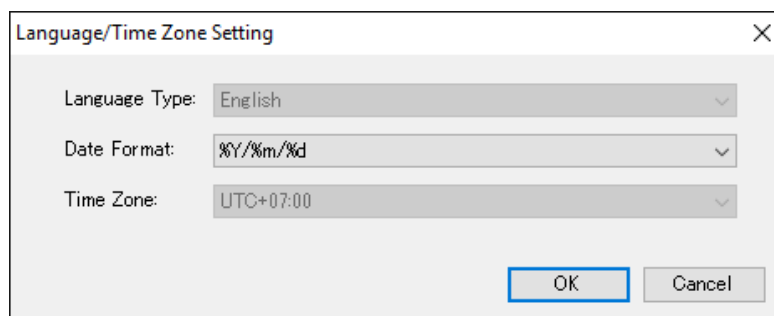

Setting Item	Description
Language Type	Select a language to view collected data of EQ100 on the Web UI screen. Fixed to "Japanese".
Date Format	Select a date format in EQ100 Web UI screen from: - %Y/%m/%d (e.g.: 2013/12/31) - %Y-%m-%d (e.g.: 2013-12-31) - %m/%d/%Y (e.g.: 12/31/2013)
Time Zone	You can view the time zone specified upon EQ project creation.

3) Click [OK].

7.6.3 EQ100 Time Synchronization

■ Function

Set a reference to adjust the time of EQ100.

■ Setup Steps

1) In the setting menu, click [System Setting].

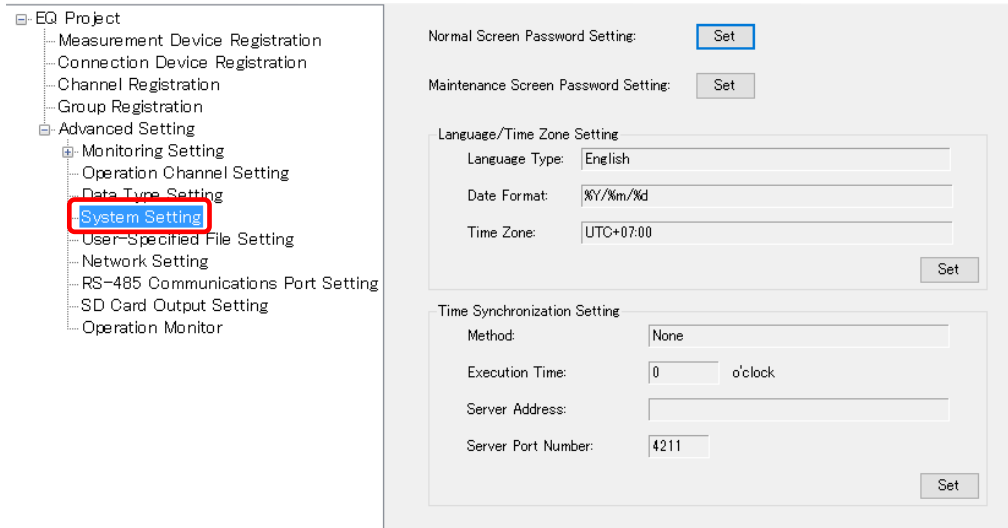

2) Clicking the [Set] button in [Time Synchronization Setting] displays the [Time Synchronization Setting] dialog box.

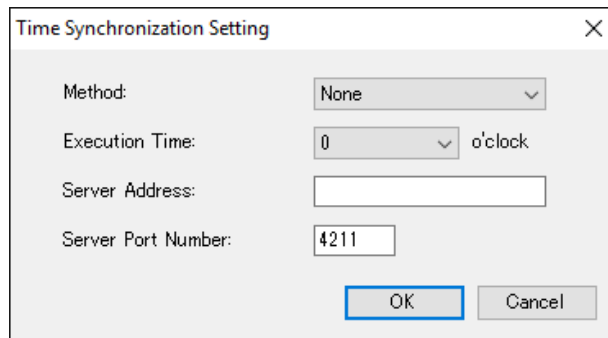

Setting Item	Description
Method	Select a time synchronization type for EQ100 from the following three options: None: To adjust to EQ100 built-in clock. Manual time synchronization of EQ100 is regularly required. The time synchronization is performed on the Web UI screen. For details, see "9.9. Maintenance > System". - SNTP Server: To adjust to the SNTP server. - EQ Server: To adjust to the EQ server.
Execution Time	Set an hour to adjust the time of EQ100. Time synchronization is performed once a day. <Selection> 0 to 23 o'clock
Server Address	Enter the server address if time synchronization is performed by the SNTP server or EQ server. <Input Range> Half-width 126 characters

Setting Item	Description
Server Port Number	Enter the server port number if time synchronization is performed by the SNTP server or EQ server. For EQ server, use the initial value "4211". For SNTP server, set the port number to "123". Initial value: 4211

3) Specify items required, and click [OK].

Reference

- To use the EQ server for time synchronization, check or allow connection permission to the port number. For detailed steps, see "EQ-Viewer User's Manual (N198-E1-01)".
- If the time synchronization type is configured as others than [None], time information is acquired from the server at the start of logging and at the specified hour of time synchronization for performing time synchronization.

7.6.4 Configuring EQ100 LAN Connection Port/Sub-LAN Connection Port

■Function

To connect a LAN-connected measurement device, configure the IP address of the EQ100 LAN or sub-LAN connection port.

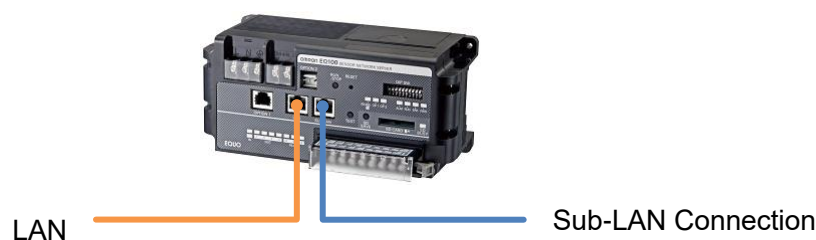

■Setup Steps

1) In the setting menu, click [Network Setting].

The screenshot shows the settings menu with 'Network Setting' highlighted. The right pane shows the 'LAN' tab with the following configuration:

Setting	Value
IP Address:	192.168.200.200
Subnet Mask:	255.255.255.0
Default Gateway:	
DNS:	

Setting	Value
IP Address:	192.168.100.201
Subnet Mask:	255.255.255.0

2) In the [Network Setting] screen, click the [LAN] tab.

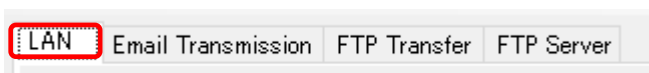

- 3) In the screen shown below, configure the LAN connection port to use.
Clicking the [Network Setting (LAN)] or [Network Setting (sub-LAN)] button displays the respective dialog box, in which configure the settings.

Setting Item	Description
EQ100 Network Setting (LAN)	<p>Set the LAN connection port of EQ100.</p> <ul style="list-style-type: none"> - IP Address: Enter an IP address. - Subnet Mask: Specify the value based on the network environment. - Default Gateway: Specify the value based on the network environment. - DNS: Specify the value based on the network environment. <p>*Initial Value IP Address: 192.168.200.200 Subnet Mask: 255.255.255.0 Default Gateway: None DNS: None</p>
EQ100 Network Setting (sub-LAN)	<p>Set the sub-LAN connection port of EQ100.</p> <ul style="list-style-type: none"> - IP Address: Enter an IP address. - Subnet Mask: Specify the value based on the network environment. <p>*Initial Value IP Address: 192,168,100,201 Subnet Mask: 255.255.255.0</p>

Precautions for Correct Use

- Do not configure the LAN and sub-LAN to the same network segment. (Addresses that are masked by the subnet mask must be different)

7.6.5 Configuring RS-485 Communications Port

■ Function

To connect an RS-485-connected measurement device, configure an RS-485 communications port.

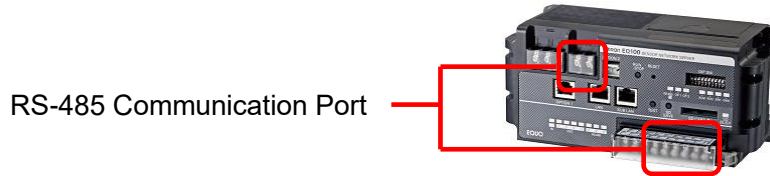

Separately specify the communications conditions for four serial communications ports (RS-485_1, RS-485_2, RS-485_3, and RS-485_4).

Shown below are factory shipment settings of the communications ports:

Item	Factory Shipment Settings
Communication Speed (bps)	9600
Data Length	7 bits
Parity	Even
Stop Bits	2 bits
RS-485 Protocol	CompoWay/F, Modbus RTU

■ Setup Steps

1) In the setting menu, click [RS-485 Communications Port Setting].

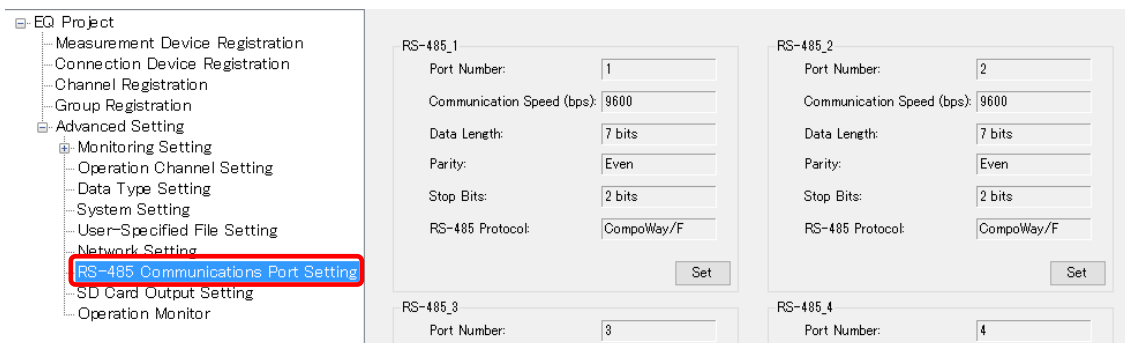

2) Click the [Set] button of the RS-485 communications port you want to configure.

3) In the [RS-485 Communications Port Setting] dialog box, select setup items and click [OK].

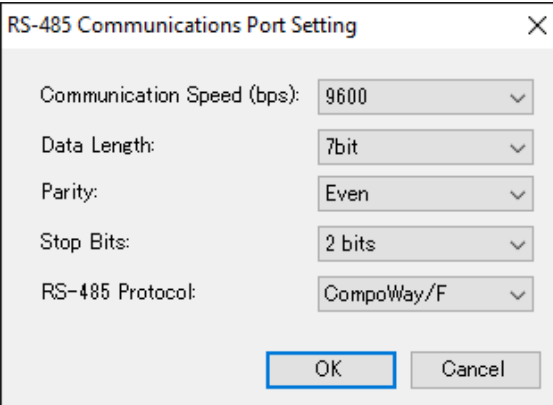

RS-485 Communications Port Setting

Communication Speed (bps): 9600

Data Length: 7bit

Parity: Even

Stop Bits: 2 bits

RS-485 Protocol: CompoWay/F

OK Cancel

Setting Item	Description	Item
Communication Speed (bps)	Select a communication speed.	9600 / 19200 / 38400
Data Length	Select a data length.	7 bits / 8bits
Parity	Select parity.	None / Even / Odd
Stop Bits	Select a stop bits.	None / 1 bit / 2 bits
RS-485 Protocol	Select a protocol to use.	CompoWay/F / Modbus RTU

7.6.6 Changing Password for Access from Web UI Function

■Function

Specify a password for access to the Web UI screen of EQ100.

There are following two types of settings:

Setting Item	Description
Normal Screen Password Setting	Access to EQ100 is protected by a password.
Maintenance Screen Password Setting	Setup change on the maintenance screen (system/operation check/update) after access to EQ100 is protected by a password.

■Setup Steps

In the EQ-Manager setting menu, click [System Setting].

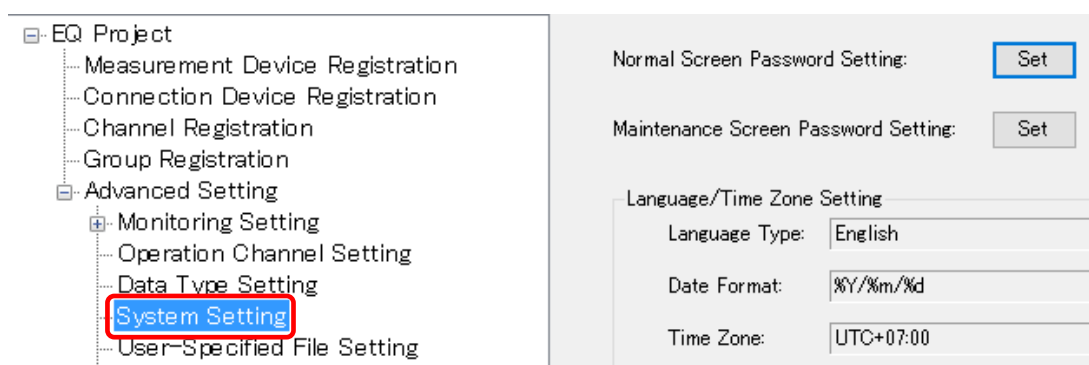

●Normal Screen Password Setting

- 1) Clicking the [Set] button in [Normal Screen Password Setting] displays the [Normal Screen Password Setting] dialog box.

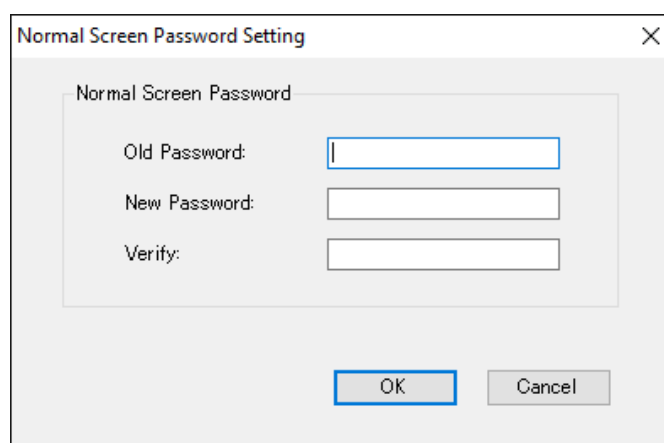

Setting Item	Description
Normal Screen Password	Old Password: Enter the old password. New Password: Enter a new password. Verify: Enter a new password again. <Input Range> Half-width63 characters <Initial Value> None

- 2) Enter the password and click [OK].

● Maintenance Screen Password Setting

- 1) Clicking the [Set] button in [Maintenance Screen Password Setting] displays the [Maintenance Screen Password Setting] dialog box.

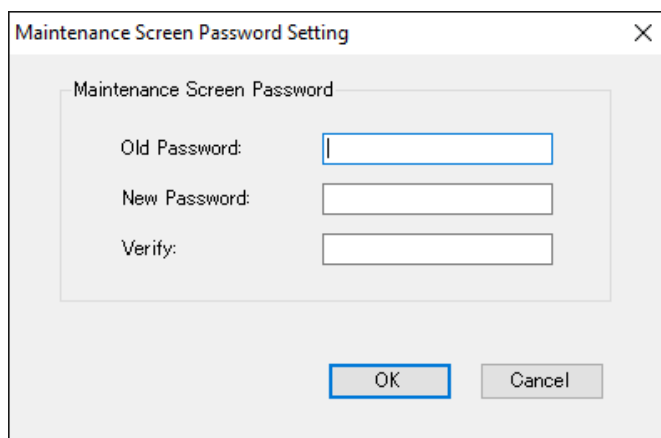

Setting Item	Description
Maintenance Screen Password	Old Password: Enter the old password. New Password: Enter a new password. Verify: Enter a new password again. <Input Range> Half-width63 characters <Initial Value> admin (half-width lowercase)

- 2) Enter the password and click [OK].

7.7 Output Setting of Collected Data/Event Log File

7.7.1 Overview

You can take out collected data files and event log files from EQ100.

Depending on the EQ-Manager setting types, available files differ as shown below:

Yes: Available, N/A: Not available

File Name	EQ-Manager setting		
	SD Card Output Setting	FTP Server Setting	FTP Client Setting
Internal System File	Yes	Yes	Yes
User-Specified File	N/A	Yes	Yes
Event Log File	Yes	Yes (*)	N/A
Refer to:	See "8.1.7.7.3. SD Card Output Setting".	See "8.1.7.7.4. FTP Server Setting".	See "8.1.7.7.5. FTP Transfer of Collected Data".

* Only the event log files saved on an SD card

Shown below are settings to take out the files logged in the EQ100 internal memory.

For operations of Web UI to take out, see "9. Web UI Function".

Precautions for Correct Use

- EQ100 saves collected data in the internal memory for up to one week. Collected data over one week are overwritten by newly collected data and collected data files from the oldest ones.
- Data from measurement devices collected in EQ100 must be saved in a computer or an SD card attached to EQ100 within one week interval.
- In transferring the collected data to FTP using the FTP client setting, it is necessary to select the file either from the Internal System file or the User-Specified file.

7.7.2 User-Specified File

A user can specify and create a file available for FTP.

CSV files are created in a user-specified interval, in UTF-8 coding fixed.

Specify a date format and header column titles for the CSV files.

Files of measured data are created in a specified output interval if the output is specified.

If an interval of one hour is specified for 1-minute collecting, for example, a file of data from 12:00 to 12:59 is created in 12:59.

● User-Specified File Designation Screen

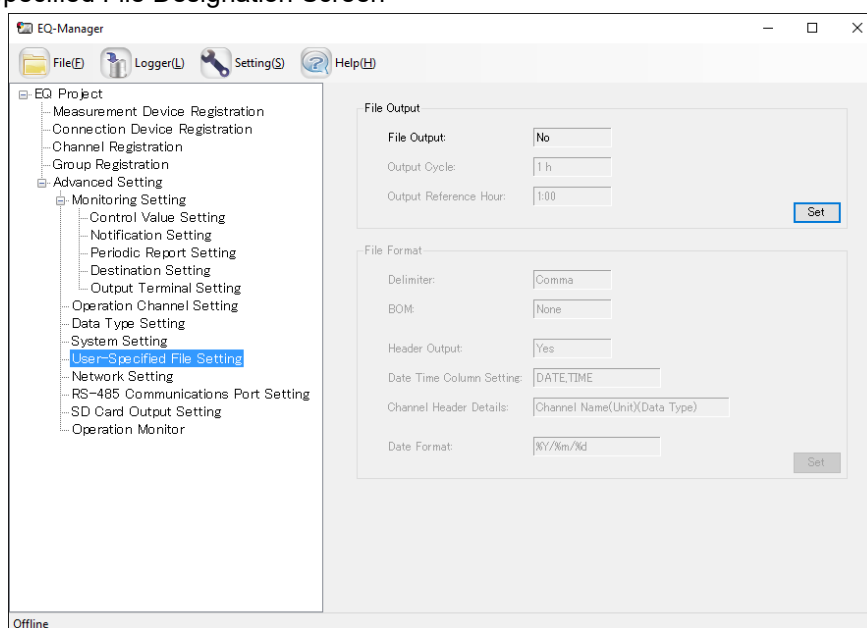

Setting Item	Description	Item
File Output	Specify whether a user-specified file should be created or not.	Yes/No
Output Cycle	Specify a cycle to create the files.	Select from 1, 5, 10, or 30 minutes or 1, 6, 12, or 24 hours.
Output Reference Hour	If an interval is over one hour, specify a reference hour for an hour to output. For example, if a reference hour is 2:00 and an output interval is 6 hours, output is done at 2:00, 8:00, 14:00, and 20:00.	Select from 0 o'clock to any time in 23
Delimiter	Specify a field separator for CSV. Fixed.	Comma
BOM	Specify whether BOM is attached or not.	Yes No
Date Time Column Setting	Specify the number of columns for a date in the top columns.	3 columns (date, time, millisecond) 2 columns (date, time) 1 column (date, time)
Date Format	Specify a date format. Fixed.	- %Y/%m/%d (e.g.: 2013/12/31)
Header Output	Specify whether the header line should be outputted or not in the 1st line.	Yes/No
Channel Header Details	Specify the details of the label in the 1st line of a CSV file.	Channel Name Channel name (unit) Channel name (unit)(data type)

Precautions for Correct Use

- A user-specified file is created on RAM. If the power of EQ100 is turned off, the file will be lost.
- User-specified files are deleted from the oldest one if the internal RAM is full. The RAM capacity is for 1 day in case of 1-minute collecting for 500 channels. Data must be fetched within 24 hours if you fetch data with FTP from outside.
- If data of 1-minute collecting cycle is included, the output interval must be 12 hours or less.
- The User-Specified file is mandatory for FTP use. The file is not saved in the SD card.

- The User-Specified files cannot be imported to the database of EQ server. For import, use the Internal System files.

7.7.3 SD Card Output Setting

■ Function

Configure so as to output collected data of EQ100 to an SD card in a CSV file. Output is done once a day at a specified hour to an SD card. The SD card can be used for commercial software such as Excel or EQ-Viewer to view data.

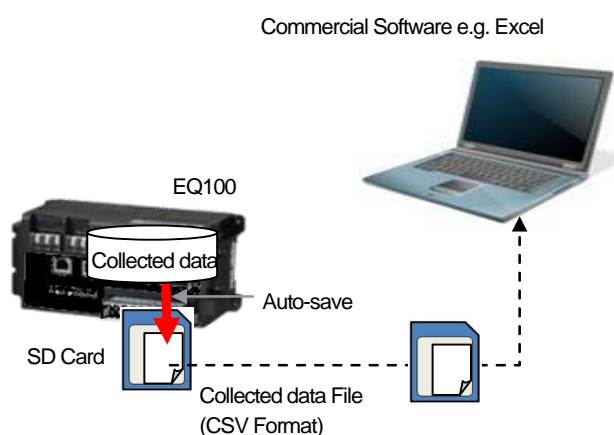

■ Setup Steps

- 1) In the EQ-Manager setting menu, click [SD Card Output Setting].

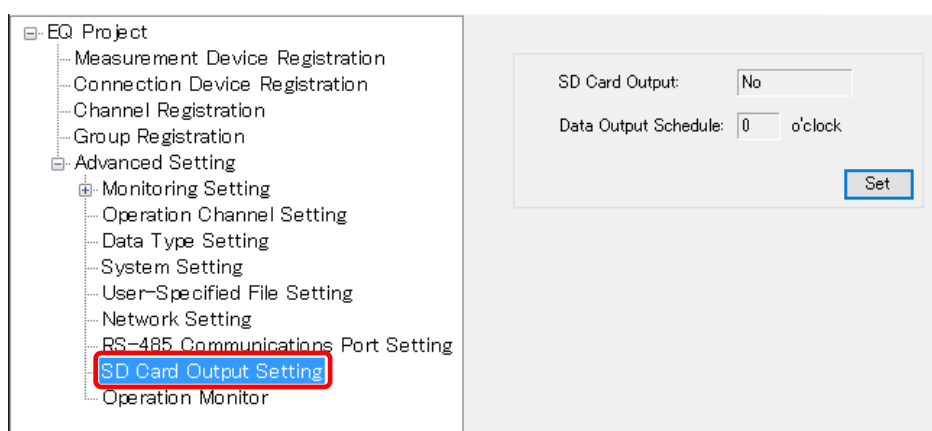

- 2) Clicking the [Set] button displays the [SD Card Output Setting] dialog box. Select the [SD Card Output Availability] check box and select a data output scheduling hour.

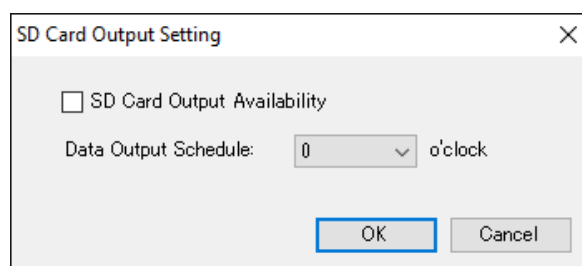

- 3) Click [OK].

Reference

- Press the SD card save button of EQ100, or on the Web UI screen select [Maintenance] - [System] - [SD Card Data Output], to output collected data to an SD card manually.

7.7.4 FTP Server Setting

■ Function

When the FTP server setting is configured, EQ100 can be operated as an FTP server. You can fetch collected data files in the EQ100 internal memory or an SD card attached to EQ100 using an FTP client.

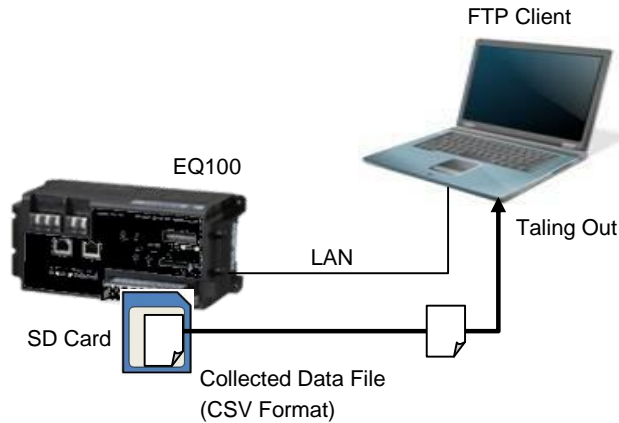

■ Setup Steps

On EQ-Manager, configure EQ100 as an FTP server.

- 1) In the EQ-Manager setting menu, click [Network Setting].



- 2) Click the [FTP Server] tab then the [Set] button.



- 3) In the [FTP Server Setting] dialog box, select the [Enable FTP Server] check box and configure [Account] and [Password].

Setting Item	Description
Enable FTP Server	Specify whether the FTP server should be enabled or not.
Account	Specify an account to connect to the FTP server. <Input Range> Half-width 63 characters (initial value: ftp)
Password	Specify a password to connect to the FTP server. <Input Range> Half-width 63 characters (initial value: ftppassword)

- 4) Click [OK].

Reference

- Collected data can be taken out after collecting was started using the following steps.

■ Connecting from FTP Client

- 1) Connect EQ100 and a computer via LAN.

- 2) Use Internet Explorer or other Web browser, or FTP client software, to specify

"ftp://<EQ100 IP address>/" as the URL.

In case of factory shipment setting, enter the following URL:

- Connecting to EQ100 LAN port: ftp://192.168.200.200/
- Connecting to EQ100 sub-LAN port: ftp://192.168.100.201/

- 3) Enter the account and password.

- 4) Content of the EQ100 internal memory is displayed.

- 5) As with folder manipulation, drag and drop a collected data file/event log file to fetch.

Precautions for Correct Use

- Regardless of account and password settings of the FTP server, account ftp or anonymous can log in with any password.

7.7.5 FTP Transfer of Collected Data

■ Function

When the FTP client setting is configured, EQ100 can be operated as an FTP client. Collected data in EQ100 is transferred to the FTP server at the timing of its creation.

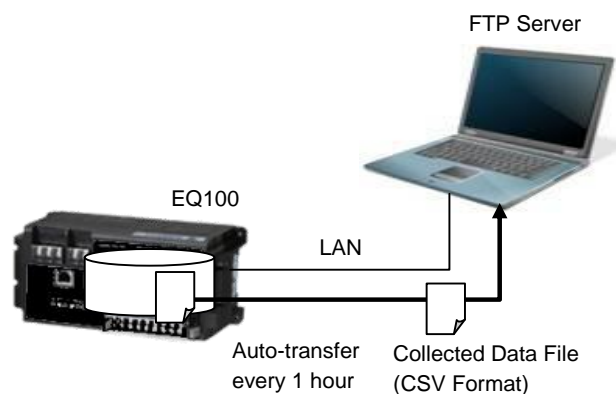

■ Setup Steps

Set an external server for FTP transfer of EQ100 collected data.

1) In the EQ-Manager setting menu, click [Network Setting].

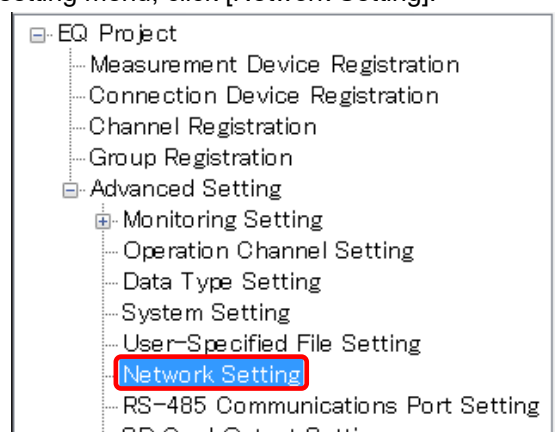

2) Click the [FTP Transfer] tab then the [Set] button.

The screenshot shows the configuration interface for FTP Transfer. At the top, there are four tabs: LAN, Email Transmission, FTP Transfer (highlighted with a red box), and FTP Server. Below the tabs, the following fields are visible:

- FTP Transfer: No
- Transfer Target: Internal System File
- Server Address: [Empty field]
- Port Number: 21
- Account: anonymous
- Password: [Masked with asterisks]
- Destination Path: /

 At the bottom right, there is a 'Set' button highlighted with a red box.

3) In the screen shown below, select the [FTP Transfer Availability] check box and configure other items.

Setting Item	Description
FTP Transfer Availability	Specify whether FTP transfer is required or not. Selecting this check box enable the FTP client function.
Transfer Target	As a target of FTP transfer, select from internal system file or user-specified file.
Server Address	Enter a destination FTP server address. <Input Range> Half-width 126 characters
Port Number	Enter a port number. Initial value: 21
Account	Specify an account to transfer to an external server. <Input Range> Half-width 63 characters (initial value: anonymous)
Password	Enter the password for the account. <Input Range> Half-width 63 characters (initial value: anonymous)
Destination Path	Enter a destination path of the FTP server. <Input Range> Half-width 126 characters (initial value: ../)

4) Click [OK].

Precautions for Correct Use

- When transfer to the FTP server fails, the collected data files that were not sent are automatically resent at the next transfer timing.
- Collected data files that were not sent yet and that can be resent are those that are within 24 hours at most. If EQ100 logging is stopped, the collected data files that were not sent yet are excluded from those that are to be resent.
- You must separately fetch those collected data files that passed more than 24 hours and that cannot be sent, as well as those that are excluded from the files to be resent due to logging stopped in the past 24 hours. In case of internal system files, use an SD card or an FTP client to fetch. In case of user-specified files, use the Web data acquisition application to fetch by specifying duration.
- Do not leave the password field blank in the FTP transmission setting.

■ Available characters for password

Available characters for password in FTP server and FTP transmission are shown below.

Blank	!	“	#	\$	%	&	‘	()	*	+	,	-	.	/
0	1	2	3	4	5	6	7	8	9	:	;	<	=	>	?
@	A	B	C	D	E	F	G	H	I	J	K	L	M	N	O
P	Q	R	S	T	U	V	W	X	Y	Z	[¥]	^	_
`	a	b	c	d	e	f	g	h	i	j	k	l	m	n	o
p	q	r	s	t	u	v	w	x	y	z	{		}	~	

7.8 Saving EQ Project

After creating an EQ project, save the EQ project on a computer as a file.

- 1) On the toolbar, click [File] - [Save].

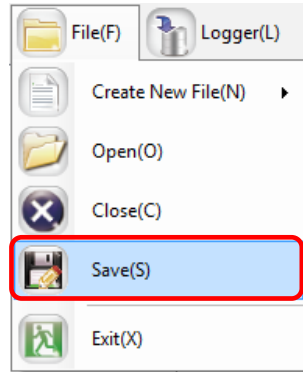

- 2) In the [Save As] dialog box, enter a file name and click [Save].

The [File Name] field shows the EQ project name. Clicking the [Save] button saves the file with the EQ project name.

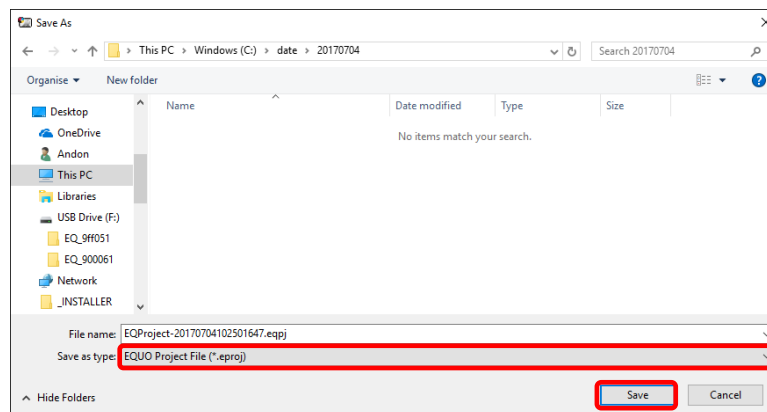

7.9 Writing EQ Project File to EQ100

7.9.1 Overview

Write an EQ project to EQ100.

To write an EQ project to EQ100, use either of the following three operations:

■ Writing through SD Card

If you try to write an EQ project for the first time, this method is recommended.

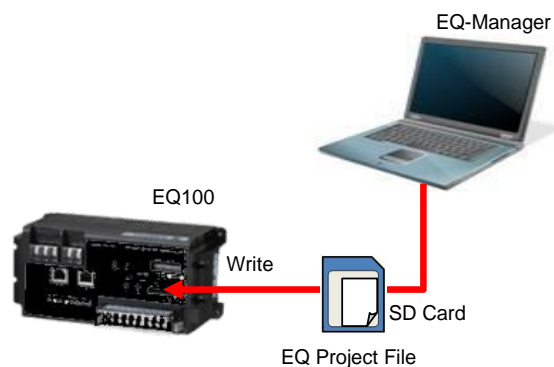

■ Writing through LAN from EQ-Manager

If this is not the first time to write an EQ project, this method is recommended.

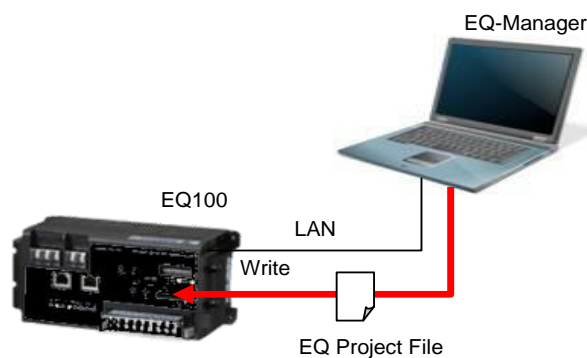

■ Writing through LAN by Web UI Operation

If an EQ project file has been acquired but EQ-Viewer has not been installed or the EQ100 is not available at hand in a close place, use this method to write.

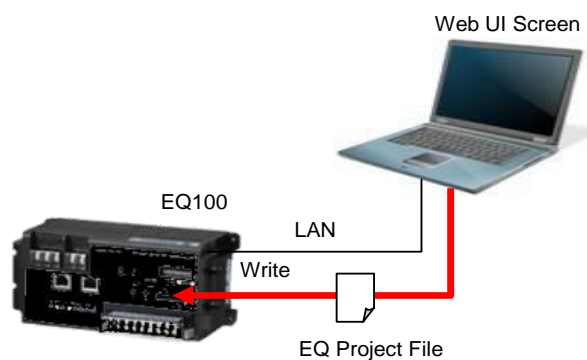

7.9.2 Writing EQ Project File through SD Card

■ Steps

- 1) Attach an SD card to a computer.
- 2) Create a folder "EQ_project" right under the SD card (root directory). The folder name is case-sensitive.

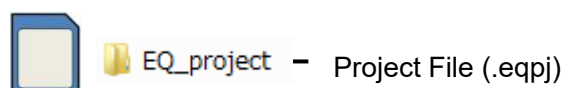

SD Card

- 3) Use EQ-Manager or Windows Explorer to save a project file (with extension of .eqpj) under the "EQ_project" folder on the SD card. You can save only one project file in the folder. See below for EQ-Manager operations:

- (1) While a project you want to write is being opened, on the toolbar click [File] - [Save].
- (2) In the [Save As] dialog box, change the place to save as the SD card and save the project file.

If you use Windows Explorer, copy the project file in the computer to the SD card.

Precautions for Correct Use

An error occurs when you try to write an EQ project file to EQ100 in the following cases. Be careful to avoid them when you save an EQ project file.

- More than one EQ project file exists in the SD card
- The EQ project file name contains " "(a space character)
- No EQ project file exists under the "EQ_project" folder of the SD card, right under the root
- The folder name right under the root does not comply with case sensitivity, as in "eq_project" or "EQ_PROJECT" instead of "EQ_project"
- Content of the EQ project file in the SD card is illegal
- The SD card is not properly attached

- 4) Eject the SD card from the computer.

- 5) Insert the SD card to the SD card slot.

(Do not write-protect the SD card)



6) Configure the setup DIP switch SW7 as ON.

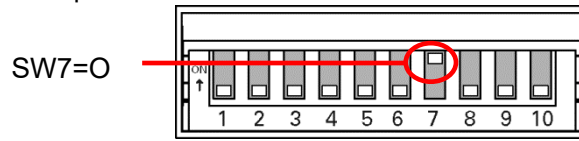

7) If the power of EQ100 is ON, press the reset button for 1 second. Right after then, the operation status indicator flashes for about 30 seconds (or the power is turned off and on again).

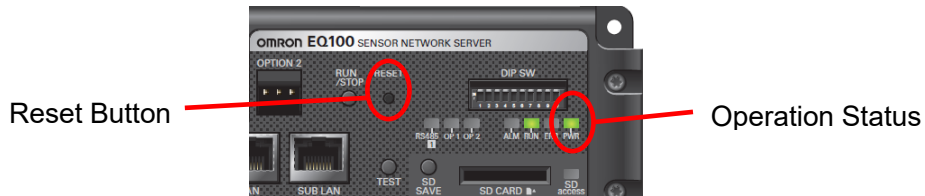

8) The project setting is written to EQ100.

While the project is being written, the collecting status indicator long-flashes.



9) After writing of the project is completed, the collecting status indicator changes from long-flashing to short-flashing, and the buzzer is sounded for four seconds.

If the device alarm indicator is on or flashing, a write error occurred. Make sure that:

- The SD card is properly inserted
- The SD card is not write-protected
- The folder name "EQ_project" is correct
- The file is under the folder

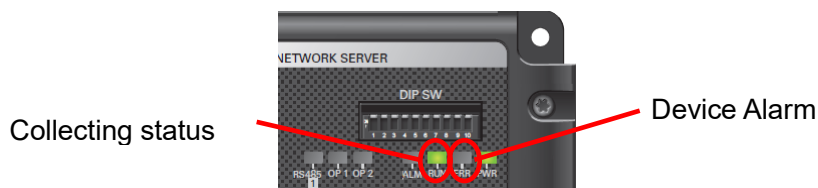

10) Configure the setup DIP switch SW7 of EQ100 back to OFF.

Precautions for Correct Use

- You cannot run the product while the setup DIP switch SW7 is ON. Always configure SW7 back to OFF before running the product.

11) Eject the SD card from EQ100 and press the reset button for 1 second. EQ100 is restarted.

Precautions

- The written project is required to edit the project later for a change of configuration, etc. Keep it for later edit.

7.9.3 Writing EQ Project by EQ-Manager

The default (factory shipment) IP address of EQ100 is 192.168.200.200.

Temporarily changing an IP address of the computer with EQ-Manager installed so as to connect to EQ100 via LAN allows writing an EQ project to EQ100 via LAN.

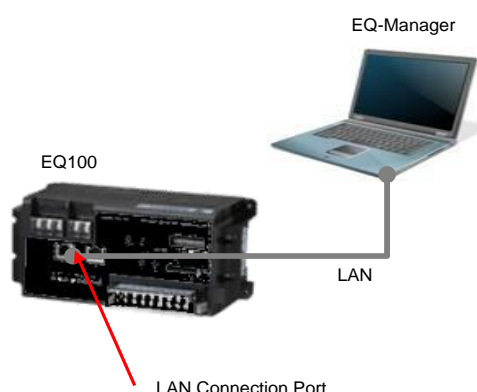

■ Required Items

- A computer with EQ-Manager installed
- EQ100
- LAN cable (either a straight or a crossover cable is available for direct connection)

■ Steps

1) Connect the computer with EQ-Manager and EQ100 via LAN.

2) Turn on the power of EQ100.

3) Change the computer's IP address so as to connect to EQ100.

Configure the following settings. For IP address setting details, refer to computer's manuals. The table below is an example of an EQ100 IP address upon factory shipment. If you have changed the EQ100 IP address already, configure the computer's IP address based on the actual EQ100 IP address.

IP Address	Set to "192.168.200.***". For "***", specify a number from 2 to 199 or from 201 to 254.
Subnet Mask	255.255.255.0
Default Gateway	Setting not required

4) Start up EQ-Manager and open an EQ project file to write.

On the toolbar click [File] - [Open] to open a target EQ project.

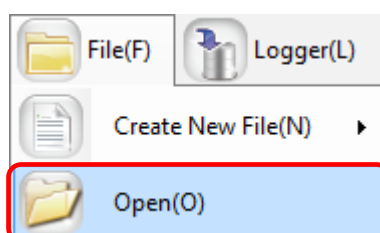

5) On the toolbar, click [Logger] - [Online].

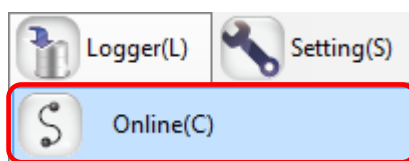

6) In the [Online Host Device] dialog box, check the displayed IP address and click [OK].
If the IP address is different from the one shown below, edit it.
EQ100 IP Address upon Factory Shipment: 192.168.200.200

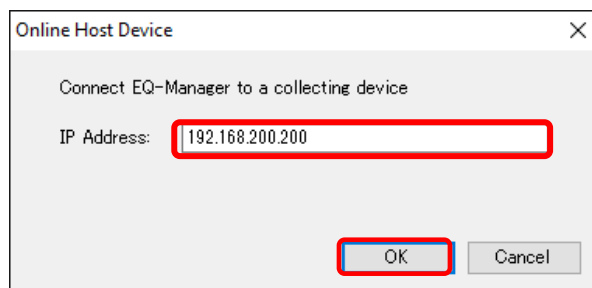

7) When online connection is done, the status bar indicates [Online].



8) Write the EQ project to EQ100.
On the toolbar, click [Logger] - [Write Setting].

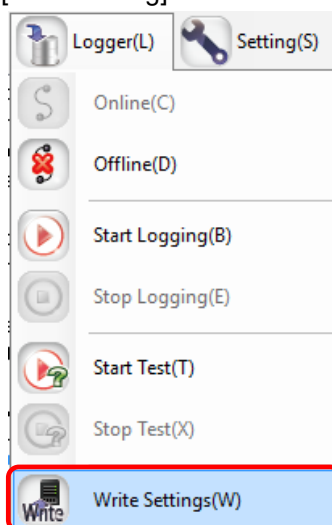

9) If a password is designated for EQ-Manager, a confirmation dialog box appears as shown below.
Enter the password and click [OK].

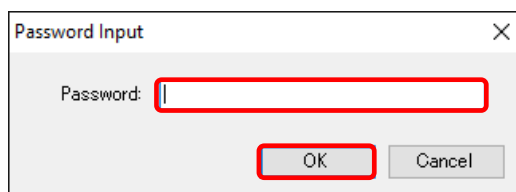

10) If the EQ project name written in EQ100 differs from the EQ project name to write, the following confirmation dialog box appears. If you are sure to write, click [OK].

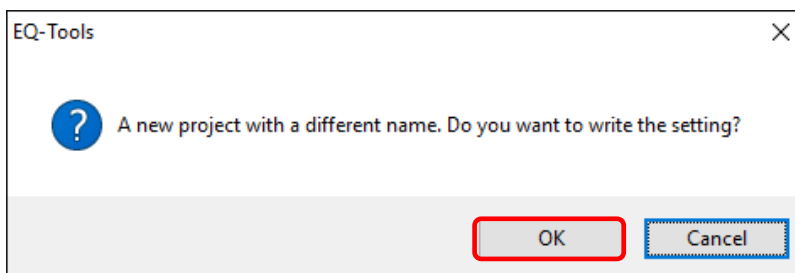

11) When the EQ project is written in EQ100, the following dialog box appears. The detail of the dialog box depends on the settings.

● If restart of EQ100 is not required

When writing is completed, a message "Completed to write the setting." appears. Click [OK].

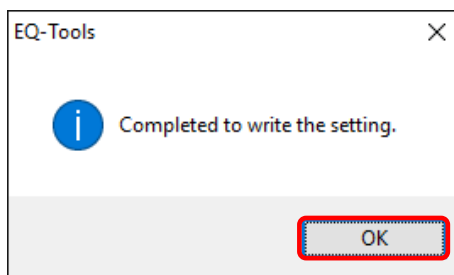

● If restart of EQ100 is required

When writing is completed, a message "Completed to write the setting. To reflect the setting, reboot EQ100. Are you sure you want to reboot now? " appears. Click [Yes].

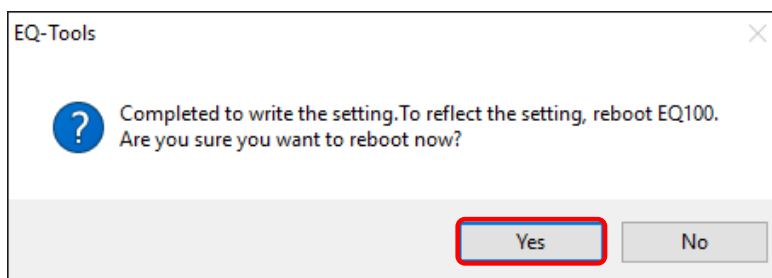

EQ-Manager and EQ100 transition to offline. EQ100 is restarted and the setting is reflected.

Precautions

- The written EQ project file is required to edit an EQ project later for a change of configuration, etc. Keep it for later edit.

12) Change the computer's IP address back.

7.9.4 Writing EQ Project by Web UI Function

The default (factory shipment) IP address of EQ100 is 192.168.200.200.

By allowing connection of a computer to EQ100, an EQ project can be written to EQ100 using the Web UI function.

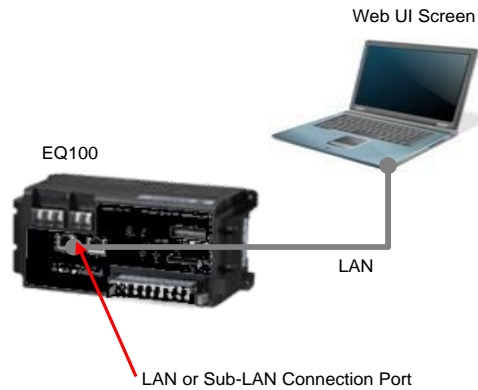

■ Required Items

- A computer with a target Web browser (Internet Explorer 8/9/10/(*)) installed
- EQ100
- LAN cable (either a straight or a crossover cable is available for direct connection)

*: Supported Internet Explorer version differs depending on EQ100 firmware version. See "9.1.1 Operating Environment".

■ Steps

- 1) Connect a computer and EQ100 via LAN.
- 2) Turn on the power of EQ100.
- 3) Change the computer's IP address so as to connect to EQ100.
Configure the following settings. For IP address setting details, refer to computer's manuals. The table below is an example of an EQ100 IP address upon factory shipment. If you have changed the EQ100 IP address already, configure the computer's IP address based on the actual EQ100 IP address.

IP Address	Set to "192.168.200.***". For "***", specify a number from 2 to 199 or from 201 to 254.
Subnet Mask	255.255.255.0
Default Gateway	Setting not required

- 4) Use a Web browser for access to the Web UI screen.
In the URL field of the browser, enter the EQ100 IP address.

- 5) On the Web UI screen, select [Maintenance] - [Update].

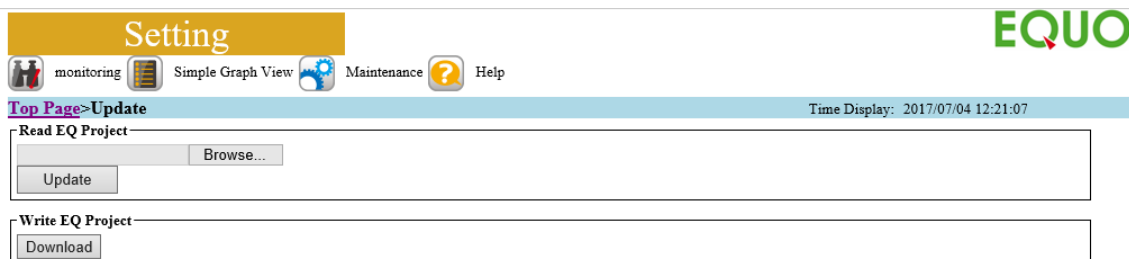

- 6) Click the [Browse] button of [Read EQ Project].
The EQ project selection screen appears.
- 7) Select an EQ project file to write to EQ100.
- 8) Click the [Update] button of [Read EQ Project].
- 9) The EQ project is written to EQ100.
When writing is completed, a message " Completed to write the setting. " appears. Click [OK]. When a message " Please restart." appears, go to (10).

Reference

- The " Please restart." message appears if the change of the setting requires a restart. For example, a change of network setup such as an IP address requires a restart.
- 10) When a message "Restart it" appears in the step 9, restart EQ100.
The EQ100 IP address has been changed.
- 11) Change the computer's IP address back.

8. Communication Test and Collecting Start

After configuring EQ100 settings and before starting data collecting, perform the communication test with measurement devices. This communication test does not log measured data to the EQ100 internal memory.

When no problem is found in the communication test, transition the status of EQ100 from setup to collecting and start the measured data collecting and logging to internal memory.

The communication test can be performed by EQ-Manager or Web UI screen. On EQ-Manager, you can check the communication status between EQ100 and measurement devices. On the Web UI screen, you can check the detailed information including communication success rate and communication speed between EQ100 and measurement devices.

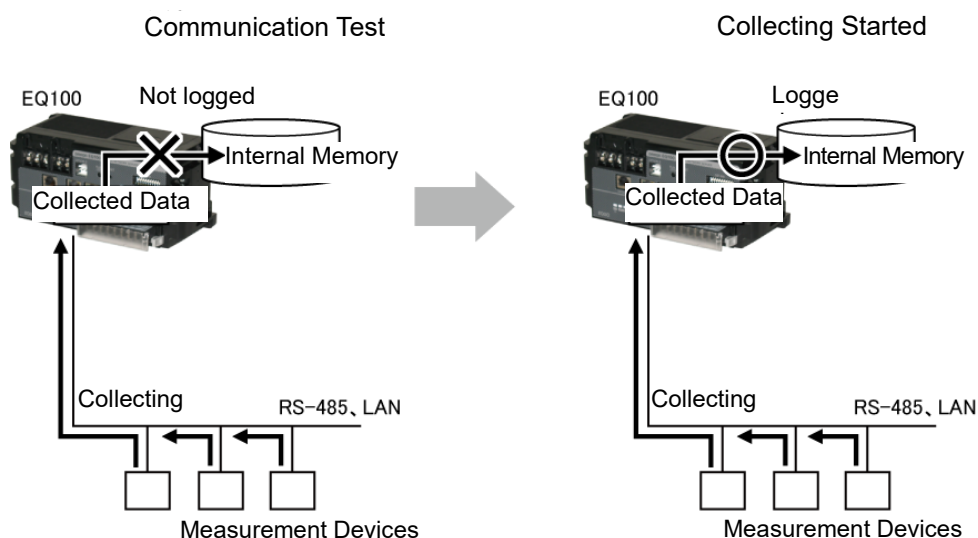

Precautions

- The communication test checks stable data collecting by EQ100 from measurement devices. Before starting the collecting, always perform the communication test.

8.1. Preparation for Communication Test

Before starting the communication test, check the following items.

- 1) The setup DIP switches SW7, SW8, and SW10 must be all OFF.



- 2) The power of EQ100 as well as all of the connection devices and measurement devices must be on.

8.2. Communication Test Operation by EQ-Manager

Shown below are steps of communication test by EQ-Manager.

8.2.1. Starting Communication Test

■ Steps

- 1) Use EQ-Manager to open an EQ project, and on the toolbar click [Logger] - [Online].

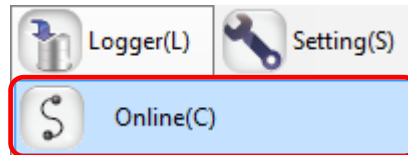

- 2) In the [Online Host Device] dialog box, check the destination EQ100 IP address and click [OK].

If the displayed IP address is different from the EQ100 IP address, edit it.

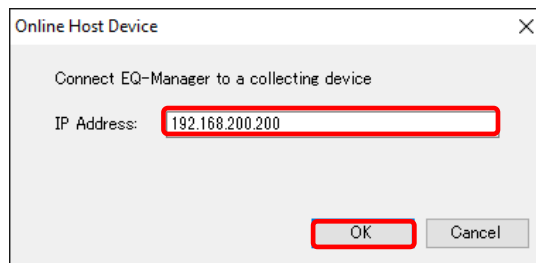

When EQ-Manager is connected to EQ100, [Online] appears on the bottom left of the screen.



- 3) On the toolbar, click [Logger] - [Start Test].

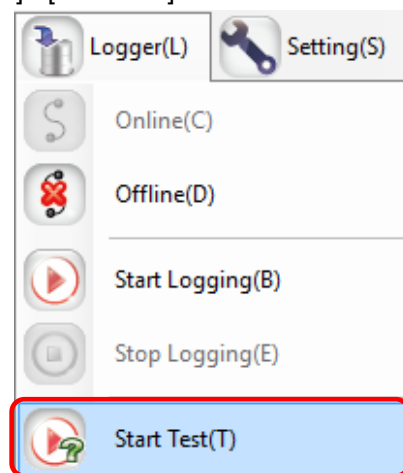

- 4) The communication test begins.

During the communications, [Online | Comm. Testing] appears.

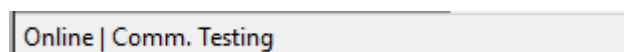

- 5) To verify the communication test result, select [Operation Monitor] in the setting menu to view. Please wait for a while before a collecting cycle of a measurement device passes.

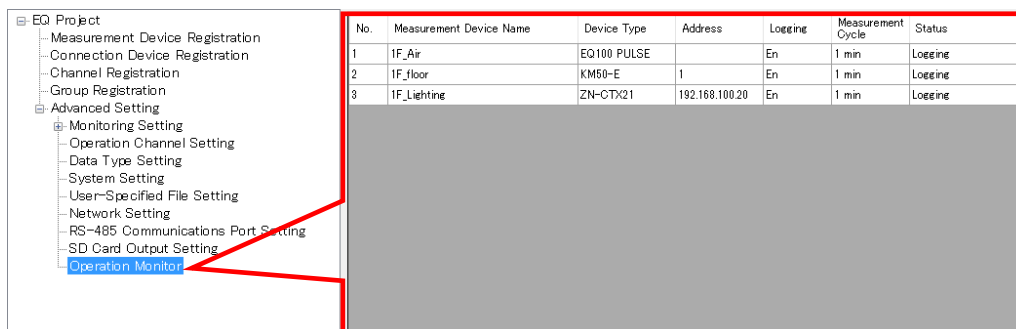

The communication test result appears in the [Status] field. Make sure that it should be [Logging].

Status	Description
--	Appears before EQ100 checks the measurement device status.
Stopped	Appears after EQ100 stopped the measurement device logging.
Logging	Appears while EQ100 is performing logging/communication test of a measurement device.
Error	Appears when communication is successful between EQ100 and a measurement device but measured data could not be collected.
Communication Error	Appears when communication is not successful between EQ100 and a measurement device.

Precautions for Correct Use

In case of a PLC, an occurrence of "Operation Stop Error" or "Operation Continuation Error" for PLC's CPU unit causes an error in the [Status] of the measurement device.

If "Low Battery" error occurred in a CPU unit, for example, "Operation Continuation Error" occurs and the EQ100 does not record data from the PLC. Replace the CPU unit's battery before "Low Battery" occurs.

* An error due to operation continuation failure does not occur for EQ100 of the firmware version 1.160 or later.

8.2.2. Ending Communication Test

■ Steps

- 1) On the toolbar, click [Logger] - [Stop Test].

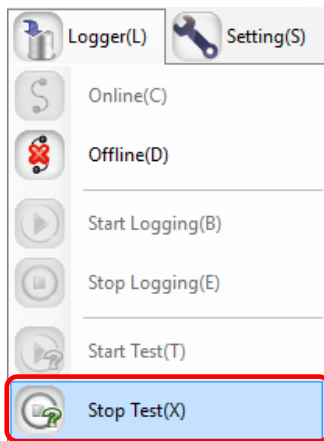

The communication test ends.

- 2) To cut the connection between EQ-Manager and EQ100, on the toolbar click [Logger] - [Offline].

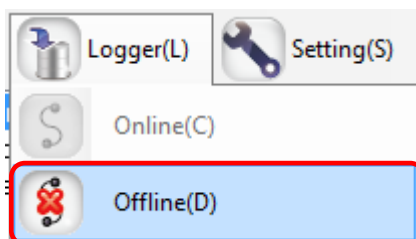

8.3. Communication Test Operation by Web UI screen

Select [Maintenance] - [System]. From the [EQ100 Operation] items on the screen, click the [Communication Test] button.

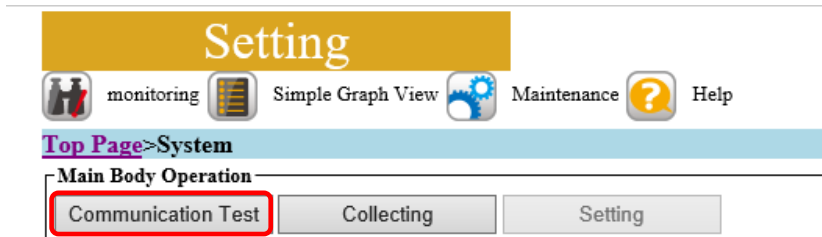

The communication test result can be viewed by selecting [Simple Graph View] - [Current Value Monitor].

For details, see "9.5. Simple Graph View > Current Value Monitor".

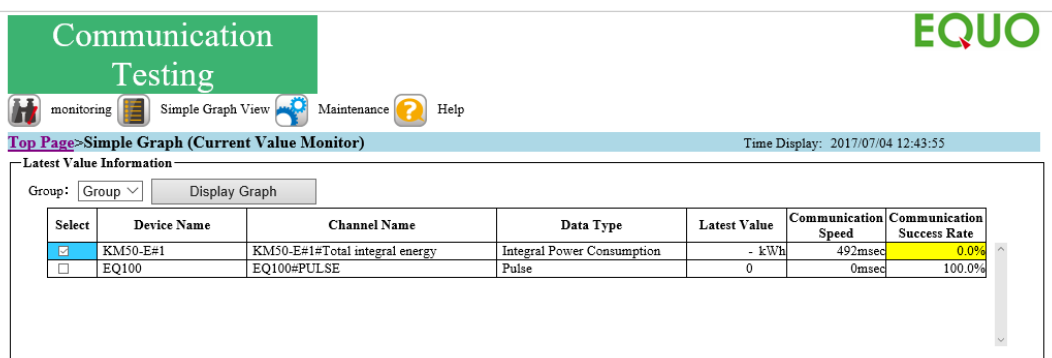

■ Actions on Communications Error

(For other than wireless device unit)

Communication Success Rate	Action
100%	- No problem on communications. Collecting can be started.
1 to 99%	- Adjust the time-out period. - Check the transmission line including the environment. - Check the connection cable.
0%	- Check the hard wiring. - Check the communications setup.

(For wireless device unit)

A wireless device unit sends data to EQ100 based on the device unit settings. Thus communication speed and communication success rate are not calculated.

If data is not sent, the latest value is displayed as "--". In such a case, check the wireless settings and radio field intensity.

8.4. Start Collecting

When no problem is found in the communication test, transition the status of EQ100 from setup to collecting and start the measured data collecting.

There are following three ways to transition the status setup to collecting:

- Pressing RUN/STOP button on the EQ100 front end
- Operation by EQ-Manager
- Operation on Web UI screen

Precautions for Correct Use

- Transition to the collecting status (starting collecting) cannot be done if the setup DIP switches SW7=ON (EQ project loading from SD card enabled), SW8=ON (firmware updating from SD card enabled), or SW10=ON (safe mode startup). Always set all of the setup DIP switches SW7, SW8, and SW10 to OFF.

Reference

- When EQ100 transitions to the collecting status, the collecting status indicator on the EQ100 front end turns on. If the transition to collecting status is successful but measured data from one or more measurement devices could not be acquired, the device alarm indicator flashes.

8.4.1. Starting Collecting by EQ100 Operation

To start collecting, press the RUN/STOP button on the EQ100 front end for 1 second or longer. The buzzer is sounded and EQ100 transitions to the collecting status. When the collecting is started successfully, the RUN LED turns on.

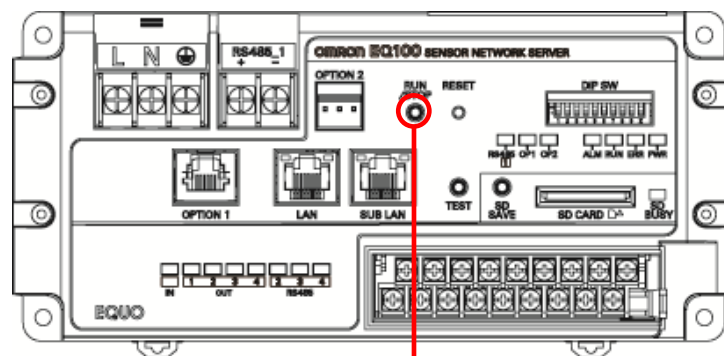

RUN/STOP Button

8.4.2. Starting Collecting by EQ-Manager Operation

To start collecting using EQ-Manager, open an EQ project and on the toolbar click [Logger] - [Start Logging] using EQ-Manager.

On EQ-Manager, you can check the EQ100 collecting status.

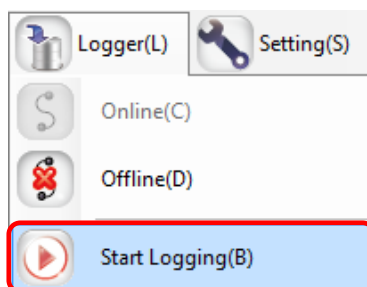

8.4.3. Starting Collecting by Web UI Screen Operation

To start collecting on the Web UI screen, select [Maintenance] - [System]. From the EQ100 Operation] items on the screen, click the [Collecting] button.

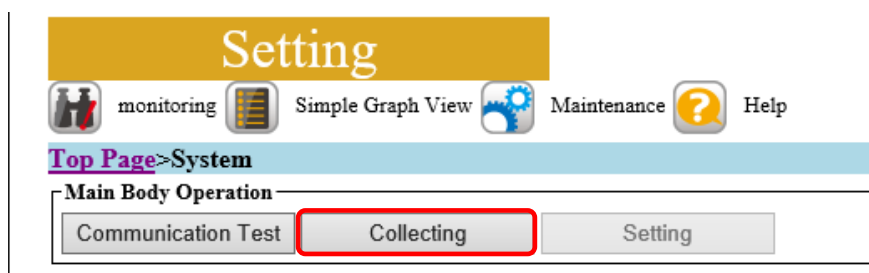

Before starting collecting, EQ100 once checks communications with all the measurement channels that are configured for collecting. Depending on the communications check result, a message appears on the Web UI screen.

■ Communications Check Successful

On the Web UI screen, a message "Transitioned to the collecting status" appears and EQ100 transitions to the collecting status. On the Web UI bottom left screen, display of [Setting] switches to [Collecting].

■ Communications Check Not Successful

On the Web UI screen, a message "A device failed on communications. Are you sure to start collecting?" appears. If you select [Yes], EQ100 transitions to the collecting status. On the Web UI bottom left screen, display of [Setting] switches to [Collecting].

If you select [No], EQ100 does not transition to the collecting status but remains in the setting status.

Precautions for Correct Use

- Some channels are not included in the communications check before EQ100 starts collecting. For details, see "9.5. Simple Graph View > Current Value Monitor", "■ Display Target of Current Value Monitor ScreenDisplay Target of Current Value Monitor ScreenDisplay Target of Current Value Monitor ScreenDisplay Target of Current Value Monitor Screen".

- Channels that are not included in the communication success rate display on the current value monitor screen are not included in the communications check.

8.5. Checking Collected Data

8.5.1. Data in EQ100 after Collecting

After measured data are collected, collected data files and event log files are saved in the EQ100 internal memory. See below for details:

■ Collected Data File

A collected data file is automatically generated once an hour.

The data can be downloaded by [File Download] operation on the Web UI screen or operations by an FTP client.

■ Event Log File

An event log file is created as one file logging all events (monitoring alarm, device alarm, and internal events) after writing an EQ project.

The data can be downloaded by selecting [System] - [Event Log] - [Download] operation on the Web UI screen.

Reference

- Outputting data on an SD card manually or automatically saves collected data files, event log files, and EQ project files on the SD card.
- The data outputted on an SD card can be downloaded by [File Download] operation on the Web UI screen or operations by an FTP client.

8.5.2. Internal Folder Structure of EQ100

Shown below is the folder structure for downloading by [File Download] operation on the Web UI screen or operations by an FTP client.

Top Page>File Download

[Document Root]

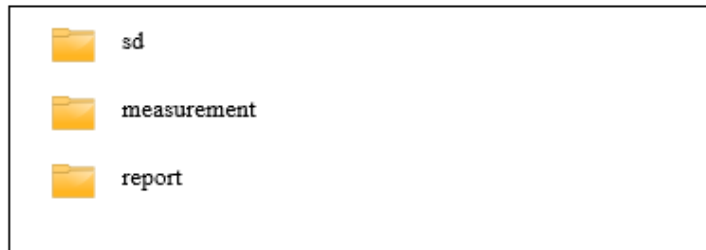

1st Level	2nd Level	3rd Level	4th Level	5th Level
"sd" folder	Folder for each EQ100 (Following EQ, SNC ID as an EQ100 identification is used as the file name) e.g.) "EQ_9ff034" folder	"event_log" folder	Event Log File (Following event_log, SNC ID and date & time is used as the file name) e.g.) "event_log_9ff034_20130514153830.csv"	-
		"project" folder	"project.eqpj" file	-
		"measurement" folder	Date folder	Collected data file of every one hour
"measurement" folder	Date folder e.g.) "20130512" folder	Collected data file in the system (every one hour) (Following SNC ID as an EQ100 identification, date and time is used as the file name) e.g.) "9ff034_20130513150000_009.csv"	-	-
"report" folder	User-specified file (collected data/user-specified interval) (Following SNC ID as an EQ100 identification, date and time is used as the file name) e.g.) "9ff034_20130513150000_20130513150959_1.csv"			

■ [Reference] EQ100 Internal Folder seeing from FTP

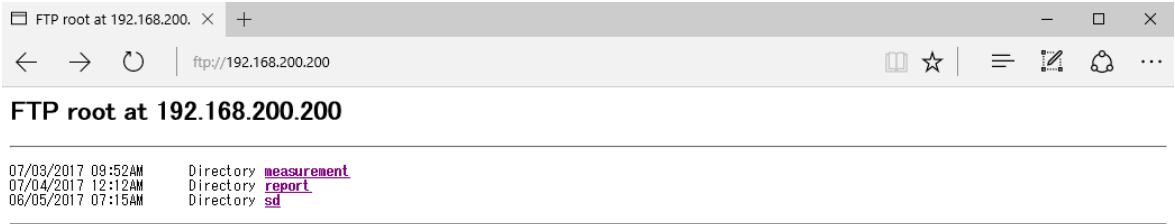

● EQ100 Internal Memory (measurement)

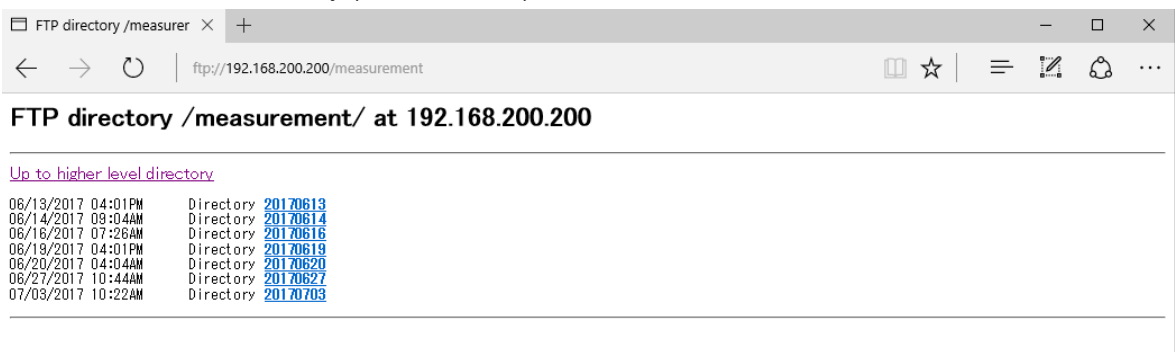

● SD Card (sd)

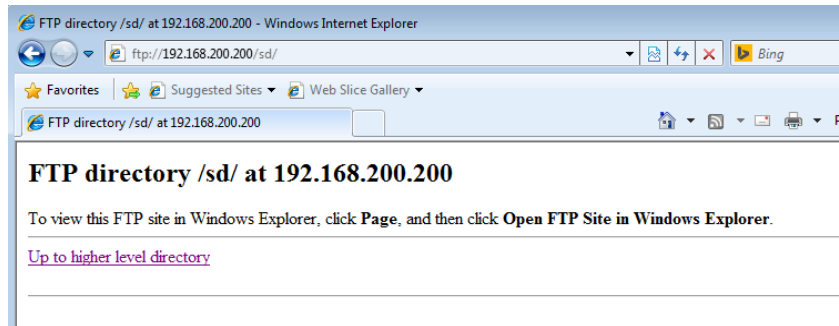

● User-Specified File Folder (report)

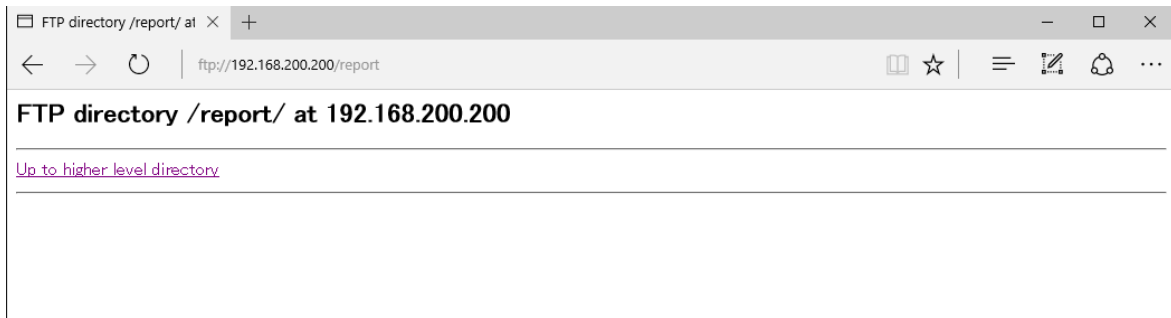

9. Web UI Function

9.1. Overview of Web UI Function

The Web UI is a function to view data incorporated into EQ100, with EQ100 and a computer connected via LAN. Major functions include:

- Status Check
- Simple Graph View
- Maintenance Function

■ Configuration of Web UI Function

Item	Description	Administrator
Top	Shows description of icons used for the Web UI screen.	
Monitor	Displays and changes the monitoring setting status.	
Simple Graph View	Displays current values and a graph.	
Current Value Monitor	Displays current values and a graph on measurement points.	
Graph View	Displays a measured data graph.	
Basic Unit View	Displays a basic unit graph.	
Maintenance	Checks EQ100 settings and outputs files (for administrator).	
Setting View	Checks the EQ100 operation status and settings.	
System	Sets the collecting status.	Yes
Operation Check	Checks the EQ100 operations including test email and general-purpose output terminal manipulation.	Yes
Data Acquisition	Acquires data in a specified period through a network to save as a CSV file.	
File Download	Checks the EQ100 operations including test email and general-purpose output terminal manipulation.	
Update	Downloads files in the EQ100 internal memory and an SD card.	Yes
Help	Refers to the product manual.	

■ Status Indication

On the top left of the screen, one of the following EQ100 statuses appears.

Setting	EQ100 is under the setting status
Communication Testing	EQ100 is under the communication test
Collecting	EQ100 is under the collecting status
System Error	An error occurred in EQ100
Not Connected	A computer and EQ100 are not being connected

Icon

Clicking icons on the screen top switches the screen views.

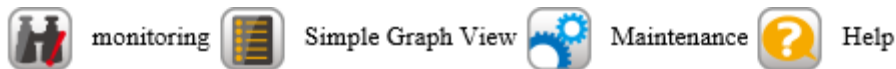

Reference

- Placing the cursor over the [Simple Graph View] and [Maintenance] icon displays a lower-level screen menu.

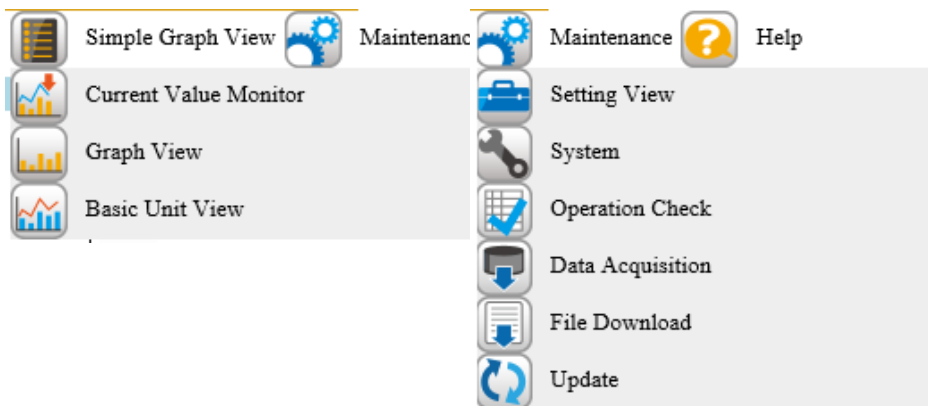

9.1.1. Operating Environment

See below for operating environment for the Web UI function:

Target OS(*1)	Windows 10, Windows Server 2012 R2 Windows Server 2016, Windows Server 2019
Target Browser(*2)	Internet Explorer 11, Edge (Chromium)
Recommended Character Size	Medium
Recommended Screen Size	1024 x 768 or higher

*1: OS editions and type of 32-bit/64-bit do not matter

*1: Windows touch panel function is not supported

*2: Supported browser differs depending on EQ100 firmware version.

EQ100 version	Browser version
1.13 or lower	Internet Explorer 8/9/10
1.14 or later	Internet Explorer 8/9/10/11
1.17 or later	Internet Explorer 11, Edge (Chromium)

Precautions for Correct Use

- The maximum number of simultaneous accesses to the Web UI screen must be limited to 4. An exclusive process is applied to operations that change the EQ100 internal status such as changing the settings and starting collecting on the System, Operation Check, or Updating screens of the Web UI screen. No such process is applied to other screens and operations that do not change the EQ100 internal status, e.g. graph view and setup display.
- Depending on a usage environment, a graph may not be properly printed by the print function of the Web browser. In such a case, please capture the screen and print it.

Precautions for Correct Use

- Disable the proxy server setting in the LAN configuration of the Web browser.
If a connection is enabled via a proxy server, the connection to the Web UI may not be available.

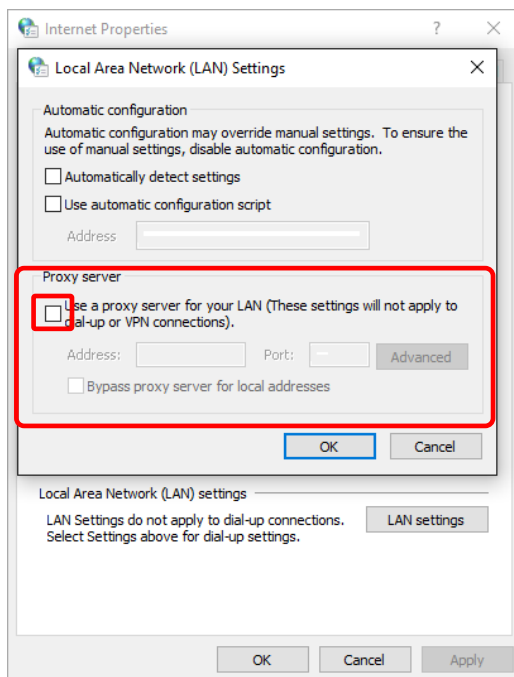

Precautions for Correct Use

- Due to Internet Explorer's specifications, a warning may appear during Web UI screen operations. You can proceed with the operations by pressing [No].

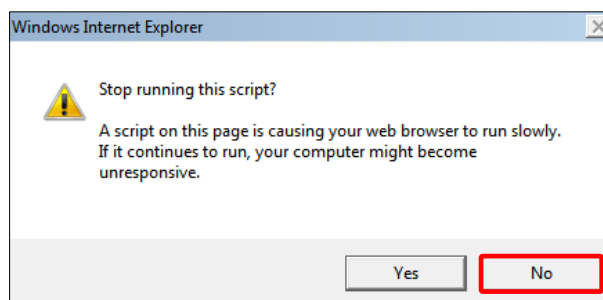

9.2. Connecting from Web Browser

Shown below are steps to connect to EQ100 using a Web browser:

■ Steps

1) Configure the LAN settings of the computer

Configure the computer's IP address so as not to overlap the ones of EQ100 and LAN-connected measurement devices.

For IP address setting details, refer to OS manuals.

Shown below are examples of a connection to EQ100 with factory shipment settings.

● Connecting to LAN Connection Port:

IP Address	192.168.200.***
Subnet Mask	255.255.255.0
Default Gateway	Setting not required

- For "***", specify a number from 1 to 199 or from 201 to 254.
- You cannot use 0 and 25.
- Specify an IP address that is not used for the LAN connection port and measurement devices connected to the LAN connection port of EQ100.

Precautions for Correct Use

- The value "192.168.200.200" is an IP address of EQ100 LAN connection port upon factory shipment or after initialization. If the address has been changed in the network setup described later, specify the IP address after the change.

● Connecting to Sub-LAN Connection Port:

IP Address	192.168.100.***
Subnet Mask	255.255.255.0
Default Gateway	Setting not required

- For "***", specify a number from 1 to 200 or from 202 to 254.
- You cannot use 0 and 25.
- Specify an IP address that is not used for the sub-LAN connection port and measurement devices connected to the sub-LAN connection port of EQ100.

Precautions for Correct Use

- The value "192,168,100,201" is an IP address of EQ100 sub-LAN connection port upon factory shipment or after initialization. If the address has been changed in the network setup described later, specify the IP address after the change.

2) Configure the setup DIP switches

Check that setup DIP switches from SW1 to SW10 should be all OFF.

3) Connect the computer and EQ100

Connect the computer and EQ100 using a LAN cable, and turn on the power of EQ100.

The operation status indicator on the EQ100 front end flashes for about 30 seconds, then stays ON after completely started up.

4) Open the Web UI screen

Start up the Web browser of the computer and enter the EQ100 IP address in the URL field.

The Windows security dialog box prompting a user name and password appears.

Shown below are IP address examples of EQ100 with factory shipment settings.

●Connecting to LAN Connection Port (Initial Value):

http://192.168.200.200/

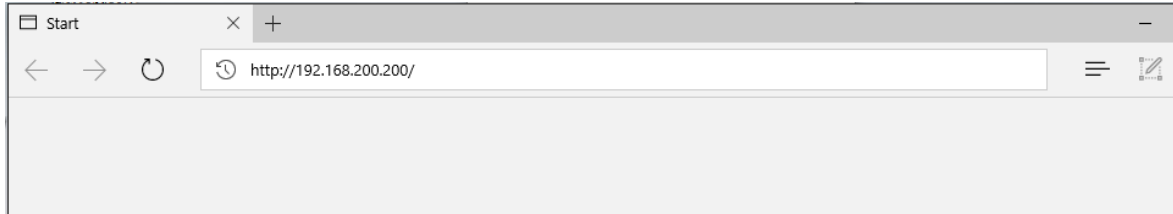

●Connecting to Sub-LAN Connection Port (Initial Value):

http://192.168.100.201/

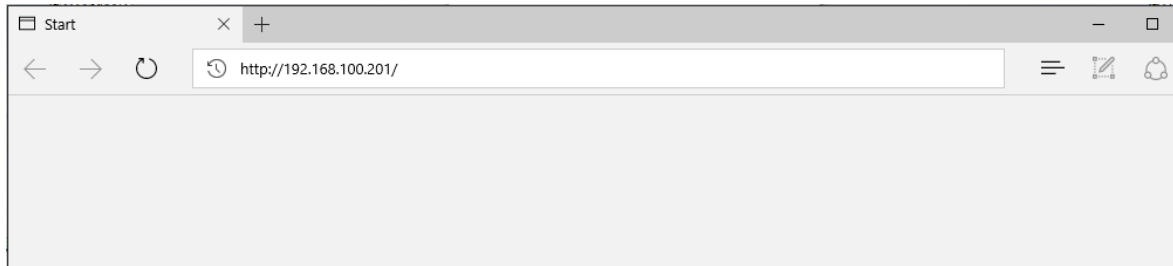

5) In the Windows security dialog box, enter the following user name and password, and click [OK]. The top page of Web UI screen appears.

Shown below are password examples of EQ100 with factory shipment settings.

●Administrator

- User Name: admin (fixed)
- Password: admin (initial value)

●General User

- User Name: user (fixed)
- Password: No password configured (initial value)

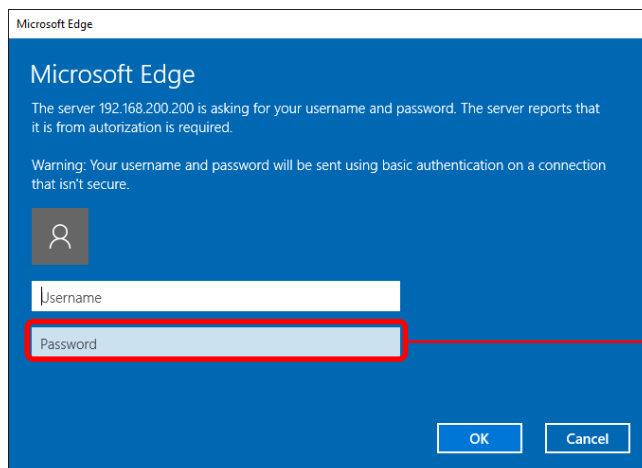

Password appears as:



Reference

- The password "admin" for the user name "admin" is an online connection password of EQ100 upon factory shipment or after initialization.
- If the login password for the Web UI has been changed, use EQ-Manager to select [Advanced Setting] - [System Setting], and change the password in the [Normal Screen Password Setting].
- The same steps can be applied to the password for the user name "user".

(EQ-Manager setting screen)

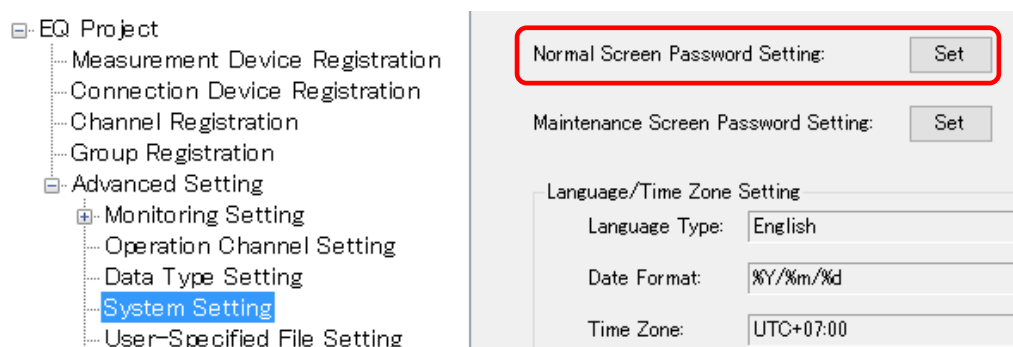

For setup details of login password setting of the Web UI by EQ-Viewer, see "EQ-Viewer User's Manual"(catalog # : N198-E1-01).

9.3. Top Screen

When the Web UI screen is opened by a Web browser, the following top page appears. On the top page, you can view the descriptions of icons used for the Web UI screen. Clicking an icon on the screen switches the screen.

■ Web Browser Screen Configuration

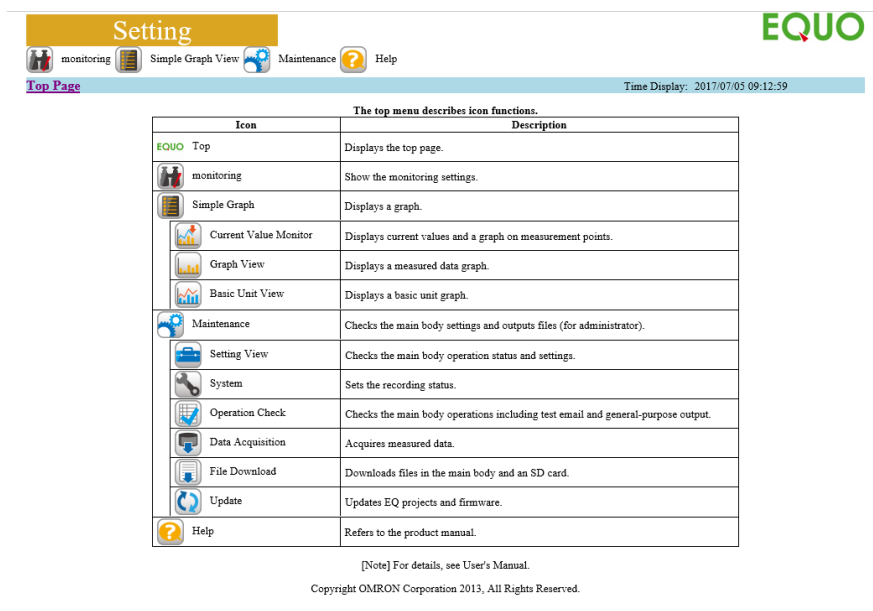

The top menu describes icon functions.	
Icon	Description
EQUO Top	Displays the top page.
monitoring	Show the monitoring settings.
Simple Graph	Displays a graph.
Current Value Monitor	Displays current values and a graph on measurement points.
Graph View	Displays a measured data graph.
Basic Unit View	Displays a basic unit graph.
Maintenance	Checks the main body settings and outputs files (for administrator).
Setting View	Checks the main body operation status and settings.
System	Sets the recording status.
Operation Check	Checks the main body operations including test email and general-purpose output.
Data Acquisition	Acquires measured data.
File Download	Downloads files in the main body and an SD card.
Update	Updates EQ projects and firmware.
Help	Refers to the product manual.

[Note] For details, see User's Manual.

Copyright OMRON Corporation 2013, All Rights Reserved.

9.4. Monitoring Screen

Clicking the [Monitor] icon on the screen top displays the following screen. In this screen the monitoring setup details appear.

■ Monitoring Screen (List View Screen) Configuration

Edit	Enabled	Group Name	Channel Name	Data Type	Upper Limit	Lower Limit
<input type="checkbox"/>	Enabled	Group	KM50-E#1#Total integral energy	Electric energy	3kWh	0.1kWh
<input type="checkbox"/>	Enabled	Group	KM50-E#1#Voltage 1 (instantaneous value)	Voltage	100V	50V
<input type="checkbox"/>	Enabled	Group	KM50-E#1#Electric current 1 (instantaneous value)	Electric current	30A	10A
<input type="checkbox"/>	Enabled	Group	KM50-E#1#Power factor (instantaneous value)	Power factor	80	40
<input type="checkbox"/>	Enabled	Group	KM50-E#1#Frequency (instantaneous value)	Frequency	70Hz	30Hz
<input type="checkbox"/>	Enabled	Group	KM50-E#1#Active power (micro)(instantaneous value)	Power	110kW	60kW
<input type="checkbox"/>	Enabled	Group	KM50-E#1#Reactive power (micro)(instantaneous value)	Reactive Power	120kvar	50kvar
<input type="checkbox"/>	Enabled	Group	KM50-E#1#CO2 converted value	CO2 emissions (instantaneous)	100kgCO2	50kgCO2
<input type="checkbox"/>	Enabled	Group	KM50-E#1#Power basic unit	Basic unit	1000kWh/	400kWh/
<input type="checkbox"/>	Enabled	Group	ZN-CTX21#192.168.100.20#Electric energy	Electric energy	1100kWh	500kWh
<input type="checkbox"/>	Enabled	Group	ZN-CTX21#192.168.100.20#Electric power	Power	150kW	75kW

Update

Caution - Changes will be lost if you turn off the power (or restart) without performing "Update Project File".

■ Description of Display Areas

Item	Description
Monitoring Setting Display Area	Displays details of the monitoring setting.
Edit button	Displays the monitoring screen (threshold setting screen) to edit the monitoring setting threshold values.
Update button	Updates the project file and saves the edited monitoring setting details. * Operation is available under the setting status. * A threshold value edited on the edit screen is a temporary value. If want to save the value, you must click this button.

Clicking the [Edit] button on the left of a monitoring condition displays the following threshold setting screen. In this area you can edit the threshold value while viewing a graph of monitoring operations for review of the threshold setting.

■ Monitoring Screen (Threshold Setting Screen) Configuration



■ Description of Display Areas

Item	Description
Display Period Setting Area	Specify a date & time to display in the date & time input field. Clicking <input type="button" value="◀"/> <input type="button" value="▶"/> buttons change the date and time back and forth. Clicking the <input type="button" value="▼"/> button allows selection of a date and time by year, month, day, hour, and minute independently.
View button	Updates the graph viewing area. Information is updated to the date and time specified in the view period setting area by clicking the button.
Channel Information Display Area	Displays the channel information to edit.
Threshold Setting Area	Displays the monitoring threshold values. Directly editing the values changes the thresholds. A change is temporarily reflected to the graph view area to check the virtual monitoring operations.
Graph Display Area	Displays a monitoring graph based on the display settings.
Update button	Updates the changed monitoring thresholds. Clicking the button reflects the edited result in the threshold setting area to the monitoring operations and the view goes back to the list view screen.
Cancel button	Discards the changed monitoring thresholds. Clicking the button goes back to the list view screen without reflecting the edited result in the threshold setting area to the monitoring operations.

*: A threshold value edited on the threshold setting screen is a temporary value. If you want to save the value, go back to the list view screen and update the project file.

9.5. Simple Graph View > Current Value Monitor

When you select [Current Value Monitor] from the menu displayed when the cursor is over the [Simple Graph View] icon on the screen top, the current value monitor screen appears. The current value monitoring screen displays the latest measured data of each measurement device.

■ Current Value Monitor Screen Configuration

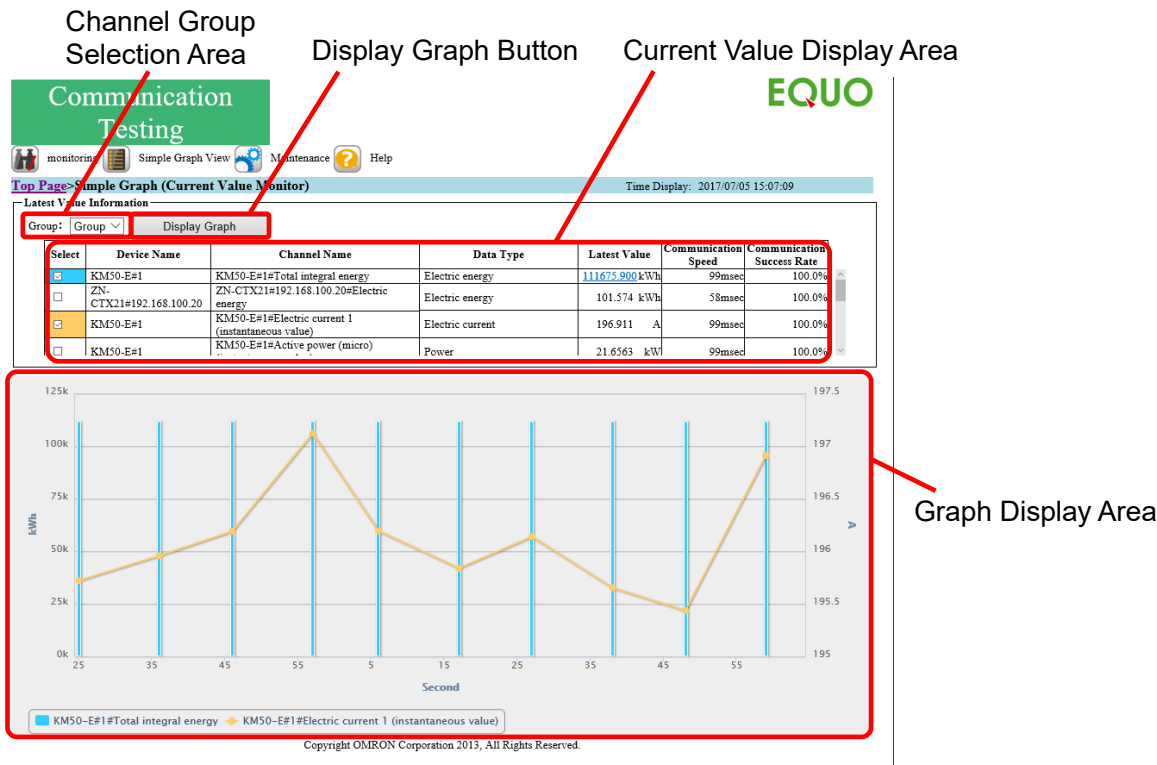

■ Description of Display Areas

Item	Description				
Channel Group Selection Area	When you select a channel group listed in the current value view area, a channel list of the selected channel group is displayed.				
Current Value Display Area	Displays a channel list of the selected channel group, as well as the latest value, communication speed, and communication success rate of each channel. You can select up to two channels to view a graph. In the communication success rate column, the latest 10 communication results with the devices. If the result is not 100%, it is indicated in yellow as shown below. <table border="1" style="margin-left: auto; margin-right: auto;"> <thead> <tr> <th>Communication Success Rate</th> </tr> </thead> <tbody> <tr> <td>100.0%</td> </tr> <tr> <td>80.0%</td> </tr> <tr> <td>100.0%</td> </tr> </tbody> </table>	Communication Success Rate	100.0%	80.0%	100.0%
Communication Success Rate					
100.0%					
80.0%					
100.0%					
Display Graph button	Displays a graph of the channel selected in the current value view area.				
Graph Display Area	Displays a graph of measured values starting from the displayed hour (in second). The view period in 1 minute and the graph is automatically updated. A measurement channel specified as "energy data" is automatically displayed in a bar graph. Other measurement channels than "energy data" are displayed in a line graph.				

■ Update Interval of Current Value Monitor Screen

The current value monitor screen is automatically updated after transitioned. Shown below are display update intervals:

Operation Status	Display Update Interval
Communication Test	10 seconds
Collecting Status	60 seconds

■ Display Target of Current Value Monitor Screen

The latest values displayed on the current value monitoring screen are measured values acquired from measurement devices. Communication speed and communication success rate are not displayed for sensors that do not use a wireless slave unit such as a thermo-humidity sensor (WZ-STH01). In addition, operation channels are not displayed.

Yes: Available, N/A: Not available

Device Type	Channel	View Target			Remarks
		Latest Value	Communications Hour	Communication Success Rate	
RS-485-Connected Measurement Device	Instantaneous Value	Yes	Yes	Yes	-
LAN-Connected Measurement Device	Integrated Value	Yes	Yes	Yes	Displays a value itself acquired from a measurement device instead of a difference from the previous value.
Wireless Device Unit (Bidirectional) PLC	Instantaneous Value/Integrated Value	Yes	N/A	N/A	A success rate cannot be calculated due to the communication system (no command issued).
Wireless Device Unit (Unidirectional)	Free Operation Channel	N/A	N/A	N/A	-
Operation Channel	Basic Unit Channel	N/A	N/A	N/A	-

■ Description of Current Value View Areas

Latest Value	Communication Speed	Communication Success Rate	Description of View Area
XX	YY msec	ZZ %	XX indicates the latest value acquired in the channel. YY msec indicates a time that took for the last communications with the device. ZZ % indicates a communication success rate of the past 10 communications with devices.
-	- msec	- %	No communications occurred with a device ever.
-	YY msec	ZZ %	Collecting of the target channel failed. YY msec indicates a time that took for the last communications with the device. ZZ % indicates a communication success rate of the past 10 communications with devices.
XX	- msec	- %	A device for which communication speed and communication success rate are not evaluated. XX indicates the latest value acquired in the channel.
-	YY msec	0 %	A communications response is returned but a value has not been acquired properly. Check the RS-485 device settings such as node overlap.

Reference

- A measurement channel specified as "energy data" in the data type setting of EQ-Manager is automatically displayed in a bar graph. A measurement channel not specified as "energy data" is automatically displayed in a line graph.

9.6. Simple Graph View > Graph View

When you select [Graph View] from the menu displayed when the cursor is over the [Simple Graph View] icon on the screen top, the graph view screen appears.

In the graph view screen, you can select a channel from a specified channel group to view in a bar graph (energy data) and a line graph (other than energy data).

■ Graph View Screen Configuration

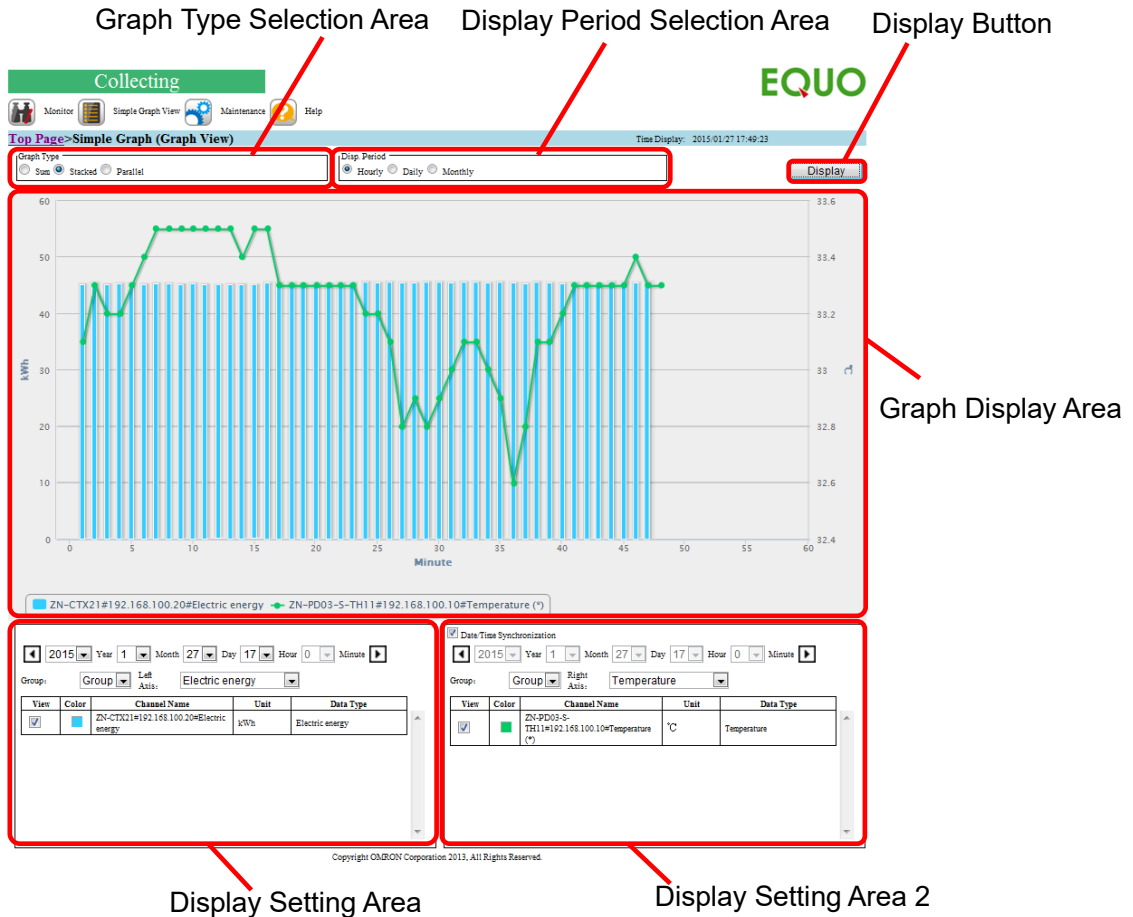

■ Description of Display Areas

Item	Description
Graph Type Selection Area	<p>Select a type of an integrated bar graph to view. A graph is switched based on the selected item.</p> <p>[Sum]: A graph of total value of the selected channels is displayed.</p> <p>[Stacked]: A stacked bar graph of the selected channels with different colors is displayed.</p> <p>[Parallel]: A paralleled (side-by-side) bar graph of the selected channels is displayed.</p> <div style="text-align: center;"> <p>Sum Graph Stacked Graph Parallel Graph</p> <p>■ Data 1 ■ Data 2</p> </div>

Display Period Selection Area	Select a view period for the horizontal direction (horizontal time span). [Hourly]: The range of horizontal time period for the entire graph is one hour [Daily]: The range of horizontal time period for the entire graph is one day [Monthly]: The range of horizontal time period for the entire graph is one month
Graph Display Area	Displays up to two graphs can be displayed based on the settings. Clicking the Display button displays a graph. A measurement channel specified as "energy data" in the EQ-Manager setting is displayed in a bar graph. Other measurement channels than "energy data" are displayed in a line graph.
Display Setting Area 1	Specify a date/time of view data, a channel group, a unit of display for the graph left axis, and a view channel.
Display Setting Area 2	If the [Date/Time Synchronization] check box is being selected, the graph is displayed synchronized with the display date/time of the display setting area 1. If the check box is cleared, you can specify any view date/time to display a comparison graph with past data. Other settings than a unit of display for the graph right axis are the same as those in view setting area 1.
Display button	Clicking this button after specifying the settings displays a graph reflecting the settings.
Graph Print button	Outputs the graph to a printer specified in the computer.
Graph Image Acquisition button	Displays a graph in the graph view area with the settings specified in the setting and selection areas.

■ Display Update Interval in Graph Display Screen

The graph display in the screen is updated upon selecting a graph type or clicking the display button.

■ Display Target of Graph Display Screen

Values displayed on the graph display screen are integrated or Instantaneous values converted from measured values collected from measurement devices. The integrated value is a difference value from the last measured value. Operation channels are included in the display. The graph shows values summarized for the view period specified in the display period selection area.

The summary method depends on the channel characteristics.

[Summary Method of Measured Data]

Integrated Value: Sum for view period

Instantaneous Value: Average for display period

Reference

- A measurement channel specified as "energy data" in the data type setting of EQ-Manager is automatically displayed in a bar graph. A measurement channel not specified as "energy data" is automatically displayed in a line graph.
- If the [Sum] graph is selected, the data type appears in the graph legend.

9.7. Simple Graph View > Basic Unit View

When you select [Basic Unit View] from the menu displayed when the cursor is over the [Simple Graph View] icon on the screen top, the basic unit view screen appears. In the basic unit view screen, you can view a graph including a basic unit of the selected channel group. For example, you can view a basic unit for each production line to check the production efficiency for the energy.

■ Basic Unit View Screen Configuration

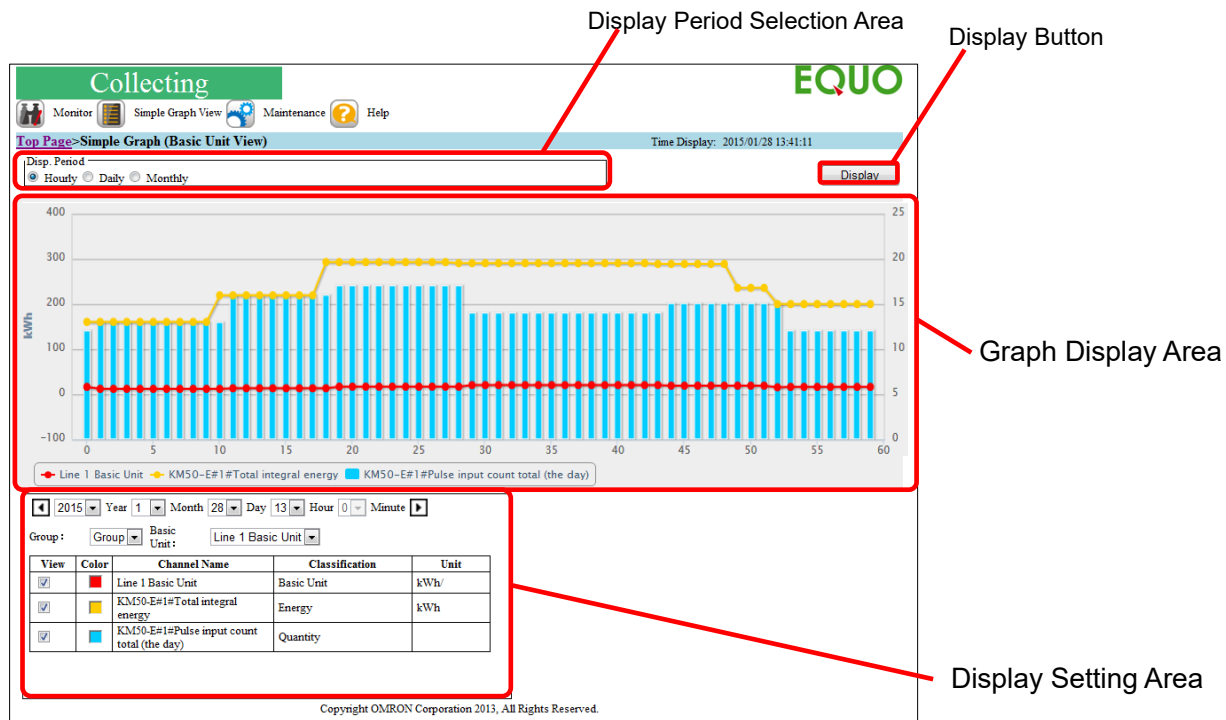

■ Description of Display Areas

Item	Description
Display Period Selection Area	Select a display period for the horizontal direction. A graph is switched based on the selected item. [Hourly]: The range of horizontal time period for the entire graph is one hour [Daily]: The range of horizontal time period for the entire graph is one day [Monthly]: The range of horizontal time period for the entire graph is one month
Graph Display Area	Displays a graph of basic unit values and denominator/numerator channel values as the original data for the operation. Basic Unit Channel Values: Line graph Numerator Channel Values: Line graph Denominator Channel Values: Bar graph
Display Setting Area	Specify a date/time of display data, a channel group and a basic unit included in a group, and a graph display of channels configuring the basic unit channel.
Display button	Displays a graph in the graph display area with the settings specified in the setting and selection areas when clicked.

■ Display Update Interval of Basic Unit View Screen

The graph display in the basic unit view screen is updated upon clicking the display button.

■ Display Target of Basic Unit View Screen

A graph in the basic unit view screen shows only the values of the channels registered as a basic unit channel.

The graph shows summary values for the view period specified in the display period selection area.

The summary method depends on channel characteristics.

[Summary Method of Measured Data]

Integrated Value: Sum for view period

Instantaneous Value: Average for display period

9.8. Maintenance > Setting View

When you select [Setting View] from the menu displayed when the cursor is over the [Maintenance] icon on the screen top, the setting view screen appears.

In the setting view screen, you can check the following EQ100 settings.

- EQ Project
- Occurred Error
- EQ100 Information
- Language/Time Zone Setting
- Time Synchronization Setting
- Network Setup
- RS-485 Setting
- Email Transmission Setting
- SD Card Data Output Setting
- FTP Transfer Setting
- FTP Server Setting
- User Specified File Setting
- Email Group Setting
- Email Notification Setting (Periodic Report Setting)

■ EQ Project

Current EQ project name in EQ100 is displayed.

EQ Project	
EQ Project	EQProject-20170529150608254

■ Occurred Error

Information of a failure and monitoring alarm currently occurring in EQ100 is displayed.

View Details: Instrument Failure, Setting/Status Error, Device Error, Communication Error, Collecting Process Error, Monitoring Alarm

Occurred Error			
Classification	Log Code	Status	Action
Instrument Failure	-	None Occurred	-
Setting/Status Error	-	None Occurred	-
Device Error	-	None Occurred	-
Communication Error	-	None Occurred	-
Collecting Process Error	-	None Occurred	-
Monitoring Alarm	-	None Occurred	-

■ EQ100 Information

The following settings of EQ100 are displayed. The EQ100 information cannot be changed by a setup file.

View Details: SNC ID, Model, Firmware Version, Safe Mode Version, Serial Number, LAN MAC Address, Sub-LAN MAC Address

Main Body Information	
SNC ID	900043
Model	EQ100
Firmware Version	SNSA1.150
Safe Mode Version	SNSA1.150
Serial Number	006705613
LAN MAC Address	00000a8a0b84
Sub-LAN MAC Address	00000a8a0b85

■ Language/Time Zone Setting

Language and time zone configured by EQ-Manager are displayed.

View Details: Language Type, Date/Time Format, Time Zone

Language/Time Zone Setting	
Language Type	English
Date/Time Format	%Y:%m:%d %H:%M:%S
Time Zone	76

Time Synchronization Setting

The following time synchronization settings configured by EQ-Manager are displayed.

View Details: Synchronization Type, Time Slot, Server Address, Server Port Number

Time Synchronization Setting	
Synchronization Type	None
Time Slot	0 o'clock (and the next hour)
Server Address	
Server Port Number	4211

Network Setting

The network settings of EQ100 LAN and sub-LAN ports configured by EQ-Manager are displayed (Default Gateway and DNS are displayed for LAN only).

View Details: IP Address, Subnet Mask, Default Gateway, DNS

Network Setting		
LAN	IP Address	192.168.200.200
	Subnet Mask	255.255.255.0
	Default Gateway	
	DNS	
Sub-LAN	IP Address	192.168.100.201
	Subnet Mask	255.255.255.0

RS-485 Setting

The RS-485 communication port settings of EQ100 configured by EQ-Manager are displayed.

View Details: Communication Speed, Data Length, Parity, Stop Bits, Communication Protocol

RS485 Setting		
Port1	Communication Speed	9600
	Data Length	7bit
	Parity	Even
	Stop Bits	2bit
	Communication Protocol	CompoWay/F
Port2	Communication Speed	9600
	Data Length	7bit
	Parity	Even
	Stop Bits	2bit
	Communication Protocol	CompoWay/F
Port3	Communication Speed	9600
	Data Length	7bit
	Parity	Even
	Stop Bits	2bit
	Communication Protocol	CompoWay/F
Port4	Communication Speed	9600
	Data Length	7bit
	Parity	Even
	Stop Bits	2bit
	Communication Protocol	CompoWay/F

Email Transmission Setting

The following EQ100 (as a sender) email settings configured by EQ-Manager are displayed.

View Details: Email Address, SMTP Server Address, SMTP Port Number, SMTP Authentication Method, SMTP Email Account, POP Server Address, POP Port Number, POP Email Account, Encoding Character String

Email Transmission Setting	
Email Address	
SMTP Server Address	
SMTP Port Number	25
SMTP Authentication Method	None
SMTP Email Account	
POP Server Address	
POP Port Number	110
POP Email Account	
Encoding Character String	iso-2022-jp

SD Card Data Output Setting

The SD card output settings configured by EQ-Manager are displayed.

View Details: SD Card Data Output Function (enabling/disabling auto-output to SD card), SD Card Output Hour (auto-save hour once a day)

SD Card Data Output Setting	
SD Card Output Function	Disabled
SD Card Output Hour	0:00

■ FTP Transfer Setting

The settings for transmission from EQ100 as an FTP client to an external FTP server, configured by EQ-Manager, are displayed.

View Details: FTP transfer enabling flag, FTP Server Address, FTP Server Port Number, FTP User Name, FTP Destination Path, file type

FTP Transfer Setting	
FTP Transfer Function	Disabled
FTP Server Address	
FTP Server Port Number	21
FTP User Name	anonymous
FTP Destination Path	/
FTP File Format (EQUO/report)	EQUO

■ FTP Server Setting

The settings to use EQ100 as an FTP server configured by EQ-Manager are displayed.

View Details: Enabling flag, FTP User Name

FTP Server Setting	
FTP Server Function	Disabled
FTP User Name	ftp

■ User-Specified File Setting

The user-specified file settings configured by EQ-Manager are displayed.

User-Specified File Setting	
File Output Function	Disabled
Output Cycle (Second)	3600
Output Reference Hour	1:00
Delimiter	" "
BOM Output	Disabled
Date Header Format	DATE, TIME
Date/Time Form	%Y/%m/%d,%H:%M:%S
Show Millisecond	Disabled
Show Header Channel Name	Enabled
Show Header Unit	Enabled
Show Header Data Type	Enabled

■ Email Group Setting

By selecting a destination group in [Destination Name], you can view the email addresses registered in the group and the valid period to send an email.

View Details: Destination group name, day of the week transmission/transmission time slot start hour/transmission time slot end hour, registered email address

Email Group Setting	
Group Name	<input type="text"/>
Registered Email Address	<input type="text"/>

■ Email Notification Setting

When you select an "Email Type" from the list, settings of respective email type are displayed.

View Details: Type (periodic report, monitoring alarm, device alarm), enabling flag, title, body, timing, group name

Email Notification Setting	
Email Type	Periodic Report <input type="text"/>
Email Transmission Function	Disabled
Title	
Body	
Timing	
Group Name	

9.9. Maintenance > System

When you select [System] from the menu displayed when the cursor is over the [Maintenance] icon on the screen top, the system screen appears.

On the system screen, you can check and configure an EQ100 operation status, time setting, SD card data output, and event logs.

■ System Screen Configuration

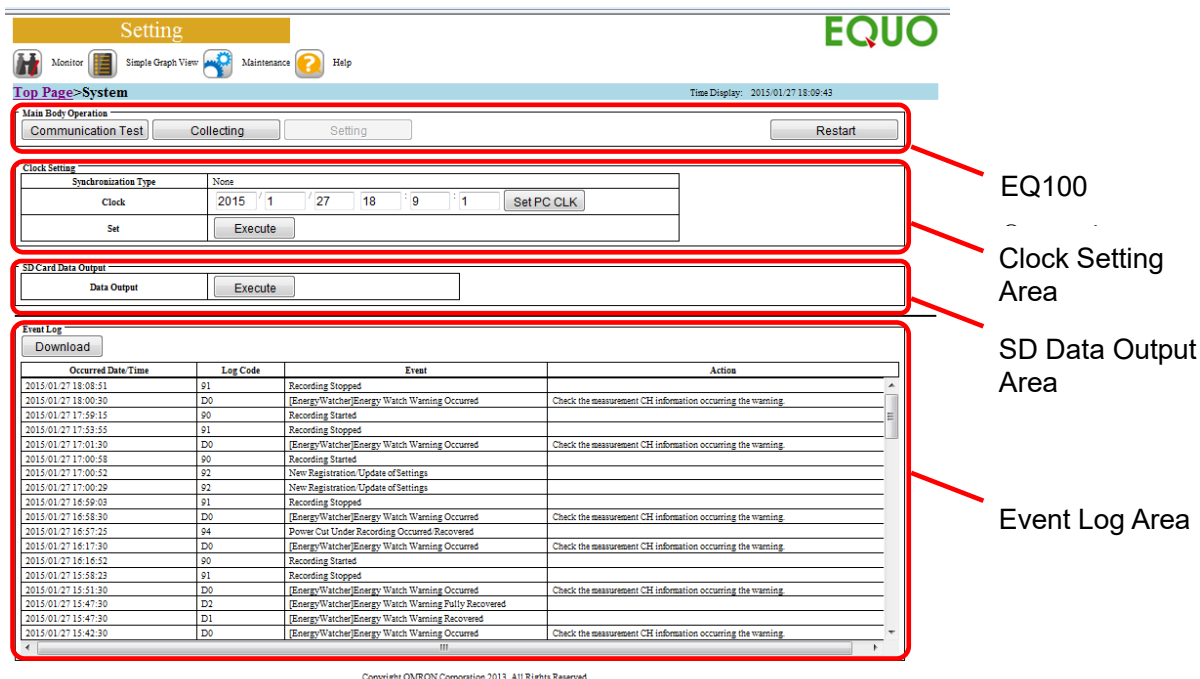

■ Description of Display Areas

Item	Description
EQ100 Operating Area	You can change an EQ100 operating status. [Communication Test]: Starts communication test. During the communication test, you can view the communication status on the current value monitor screen. [Collecting]: Starts collecting (EQ100 transitions to the collecting status). [Setting]: Stops collecting (EQ100 transitions to the setting status). [Restart]: Resets EQ100.
Clock Setting Area	If the time synchronization type is [RTC], entering date and time and clicking the [Execute] button configures the EQ100 built-in clock. Pressing the [Set PC CLK] button sets the PC's current time to the time setting area. Press the [Execute] button to set.
SD Card Data Output Area	Clicking the [Execute] button outputs collected data files and event log files to the SD card attached to the SD card slot.
Event Log Area	A list of occurred events is displayed. Clicking the [Download] button allows download of event log files.

Reference

- The event log area view is not automatically updated. To view the latest information, reload the page of the browser.

9.10. Maintenance > Operation Check

When you select [Operation Check] from the menu displayed when the cursor is over the [Maintenance] icon on the screen top, the operation check screen appears.

On the operation check screen, you can check operations of general-purpose output ports, email notification function, and FTP transfer function.

■ Operation Check Screen Configuration

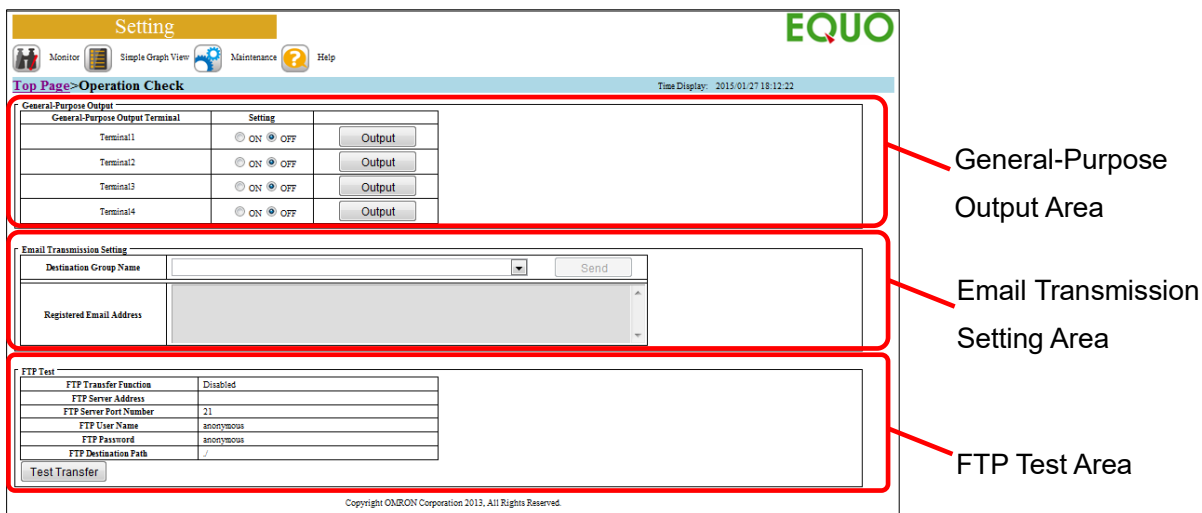

■ Description of Display Areas

Item	Description
General-Purpose Output Area	Allows testing of general-purpose output ports 1 to 4. After configuring ON/OFF of respective port, clicking the [Output] button outputs general-purpose output based on the setting. The ON/OFF status of general-purpose output ports can be checked by output status indicator on the EQ100 front end.
Email Transmission Setting Area	Allows email notification transmission test. Select a destination group name and click the [Send] button. Verify if a test email was sent to the email address registered in the destination group or not.
FTP Test Area	Allows test transmission to the FTP server. Clicking the [Test Transfer] button transfers test data to the FTP server configured in the FTP transfer setting. Shown below is a text file to be sent for the test: - File Name: ftpTestFile - Content: This file is for FTP transfer test. Check that the transferred file was saved in the configured path in the destination FTP server.

■ Precautions for Correct Use

- Be careful when you perform an output test while a general-purpose output port and an external device being connected. OMRON shall not be responsible for any impact on a connected device due to customer's operation.
- A status of general-purpose output port is kept as that operated in the operation check. After the operation check, you may need to change the status back.

■ Reference

- To perform an email transmission test, email server and email transmission settings must have been configured by EQ-Manager.
- To perform an FTP transfer test, FTP transfer settings must have been configured by EQ-Manager.

9.11. Maintenance > Data Acquisition

When you select [Data Acquisition] from the menu displayed when the cursor is over the [Maintenance] icon on the screen top, the data acquisition screen appears.

In this menu, you can acquire collected data of a specified period via network and save as a CSV file.

■ Operation Check Screen Configuration

Data Acquisition

Start
 2015 Year 1 Month 27 Day 0 Hour 0 Minute

End
 2015 Year 1 Month 27 Day 23 Hour 59 Minute

You can specify a period of 13 9 days under the current channel setting.

Output Format

Delimiter: Comma

Encoding: UTF-8 BOM

Date/Time Column Designation: DATE, TIME

Date Format: %Y/%m/%d

Header Output: Yes

Channel Header Designation: Channel Name (Unit)(Data Type)

Acquire

Copyright ONMRON Corporation 2013. All Rights Reserved.

■ Description of Display Areas

Item	Description
Period Setting Area	Specify the start and end of the data period to acquire. Select a year, month, day, and time. Note that a guideline for the available maximum period is displayed right under the area. Specify the start and end within this period.
Output Format Area	Specify an output code to save acquired data as a file. Shown below are available specifications to change: Delimiter: A CSV field separator. Fixed to comma. Encoding: The Character code is fixed to UTF-8. Specify whether BOM is attached or not. Date/Time Column Designation: Specify a column to set a date and time. Date format: Specify a format of date output. Header output: Specify whether the header line should be outputted or not in the 1st line. Date/time format: A date format. Fixed to %y%m%d (e.g. 2013/1/1). Channel Header Designation: Specify a channel label.
Acquire	Starts data acquisition and save.

9.12. Maintenance > File Download

When you select [File Download] from the menu displayed when the cursor is over the [Maintenance] icon on the screen top, the file download screen appears.

In the file download screen, you can download collected data files of EQ100 internal memory.

Precautions for Correct Use

- EQ100 saves collected data in the internal nonvolatile memory for up to one week. Collected data over one week are overwritten by newly collected data and collected data files from the oldest ones. It is recommended that collected data should be saved on an SD card every day on a specified hour even if the collected data are referred to by the Web UI function only.
- The User-Specified file is created on RAM. Accordingly, when the EQ100 is powered off, the file is deleted. When the internal RAM becomes full, the file is also deleted from the oldest one. To restore the file, acquire it in 24 hours after deletion.

Maintenance Screen Configuration

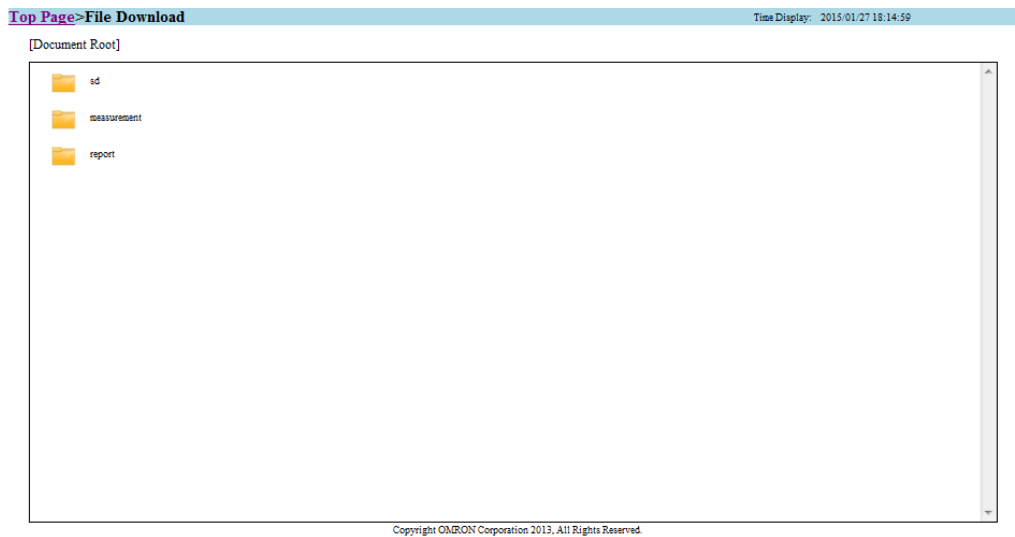

Download Steps

1) Select the "sd" folder for SD card, "measurement" for EQ100 internal memory, and "report" for a user-specified file. Select a file to download and specify a destination directory to save in the computer.

2) In the [File Download] dialog box, click [Save].

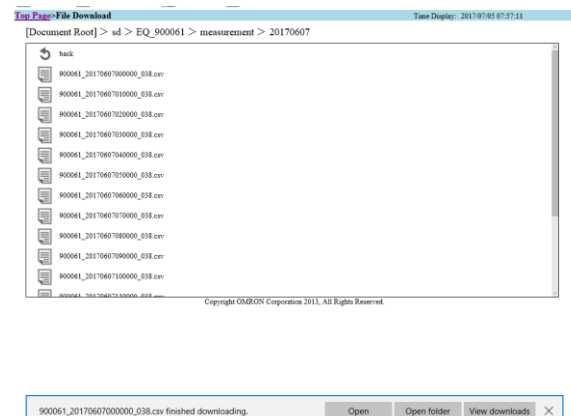

3) In the [Save As] dialog box, enter a destination to save and click [Save].

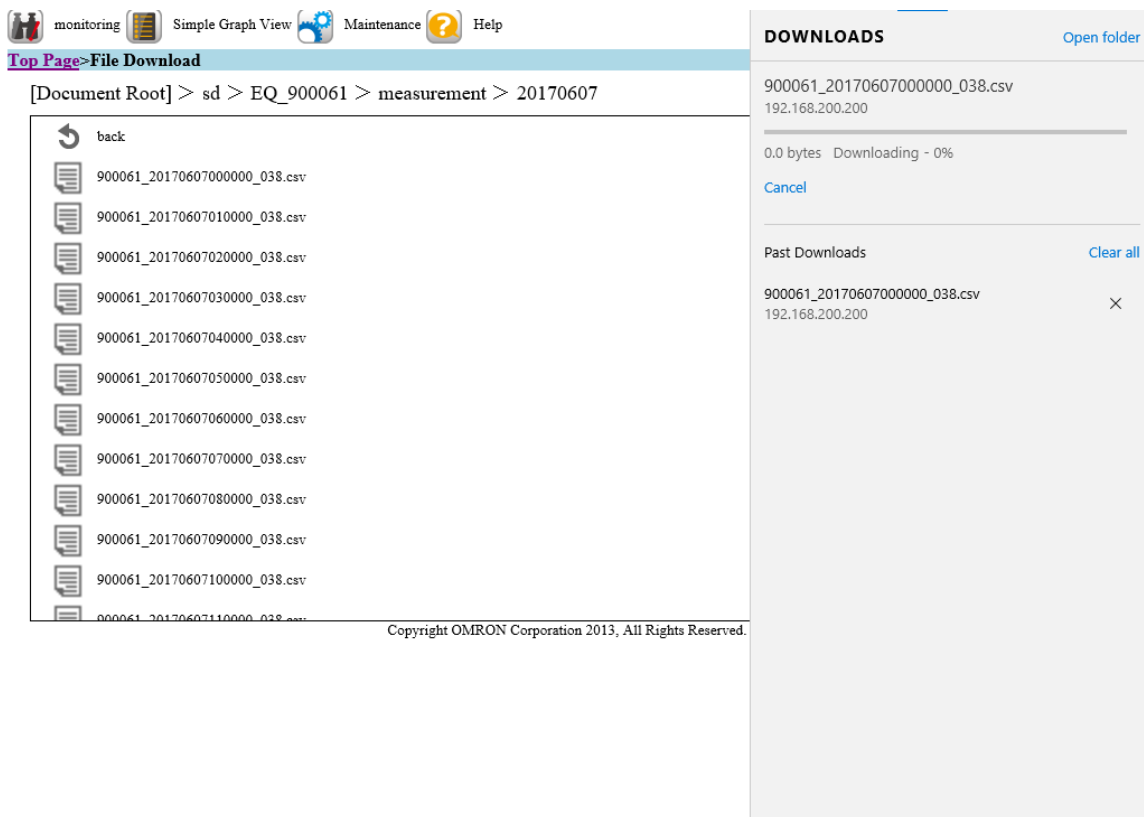

Download is completed.

9.13. Maintenance > Update

When you select [Update] from the menu displayed when the cursor is over the [Maintenance] icon on the screen top, the update screen appears.

On the update screen, you can update an EQ project and the firmware.

■ Update Screen Configuration

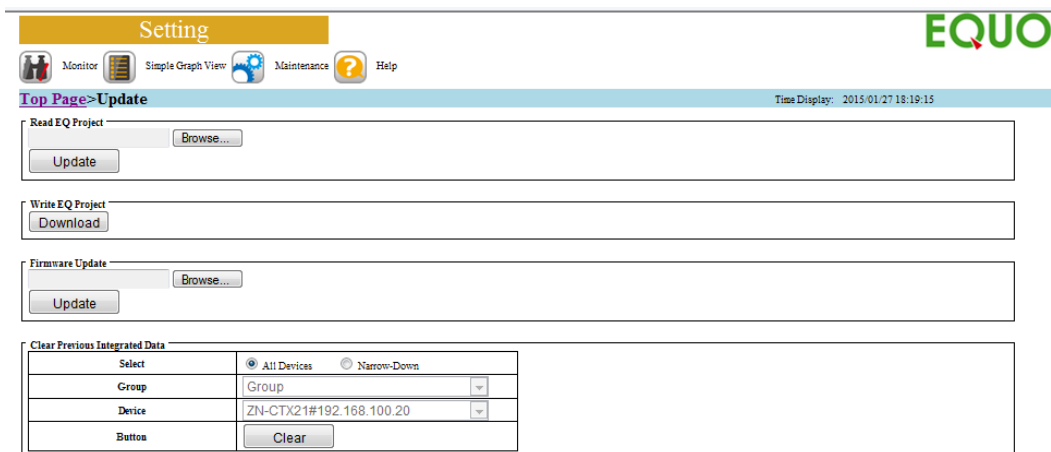

Copyright OMRON Corporation 2013. All Rights Reserved.

You can perform the following operations:

- Loading an EQ project
- Writing an EQ project
- Updating the firmware
- Clearing the previous integrated data

■ Loading an EQ project

You can update an EQ project.

Click [Browse] to specify an update file for an EQ project, and click [Update].

■ Writing an EQ project

If you want to download the current EQ project to the computer, click [Download].

■ Updating the firmware

You can update the EQ100 firmware.

Click [Browse] to specify an update file for the firmware, and click [Update]. After updating, always restart EQ100. Otherwise the update may not be effective.

■ Clearing the previous integrated data

You can clear the previous value of measured data stored in EQ100 to calculate an integrated value by EQ100 (using a differential process). Perform this operation to prevent integrated data error if integrated data such as electric energy has been changed due to a rest or replacement of a measurement device.

For all measurement devices or for respective measurement device, clear the previous measured value stored in EQ100. Select a measurement device and click [Clear].

9.14. Help Screen

Clicking the [Help] icon on the screen top displays the Help screen.
The Help screen shows a link to OMRON's Web page.

■ Help Screen Configuration

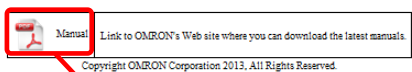

Link to OMRON's Web page

10. Viewing/Analyzing Graph on EQ-GraphViewer

EQ-GraphViewer is software to summarize collected data from measurement devices stored in the summary data DB of the EQ server for viewing and analyzing the graph. To view in the EQ-GraphViewer, it is necessary to create an EQ Server Project and make settings to the EQ server.

Major functions of EQ-GraphViewer include:

- Connecting to the EQ server and viewing/analyzing collected data
- Viewing narrowed-down channels by measurement channel group
- Flexible graph view through independent configuration of view period and summary interval
- Comparison with past data
- Detection of abnormal values by control value view
- Simultaneous view of production and energy
- CSV output setting enabling analysis by an external tool

This chapter describes basic operations for display and analysis by EQ-GraphViewer. For detailed steps, see "EQ-Viewer User's Manual".

10.1. Basic Operation Steps

Shown below are basic operation steps of EQ-GraphViewer:

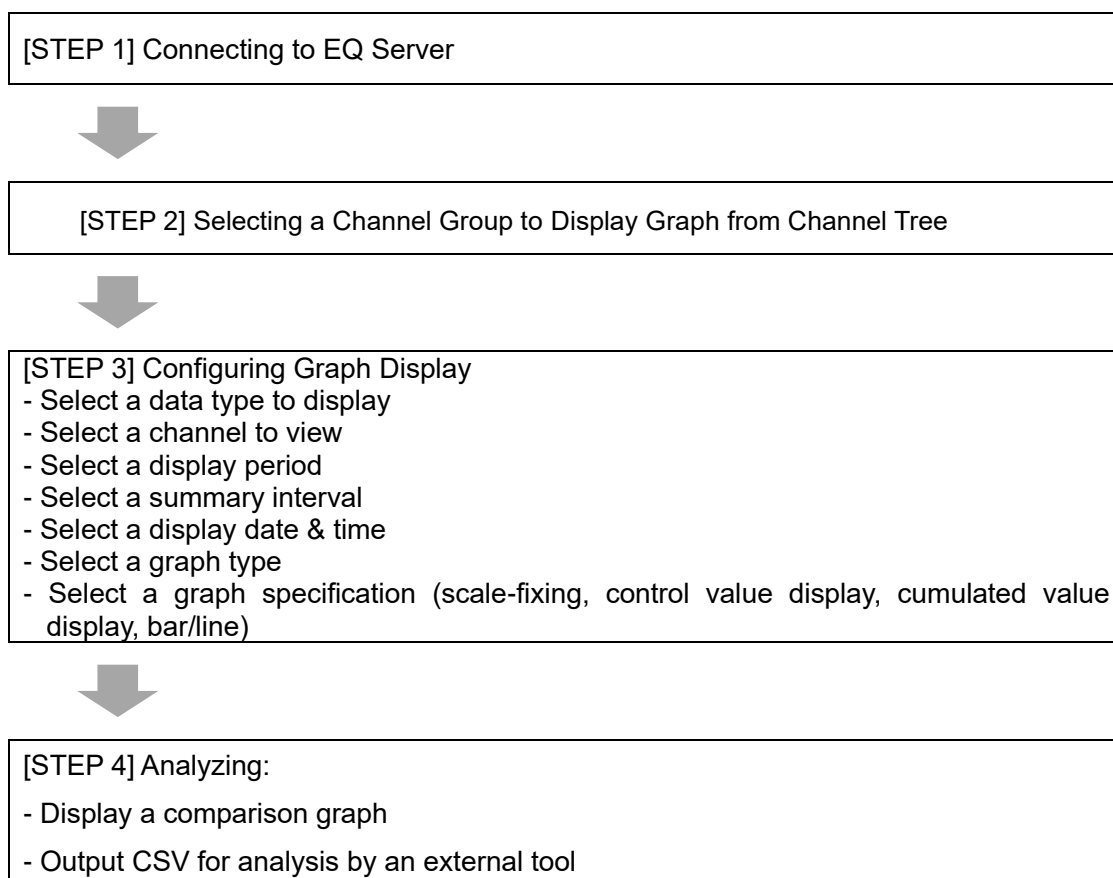

10.2. Connecting to EQ Server

Shown below are steps to connect to the EQ Server.

■ Steps

1) On the toolbar, click [File] - [Connect Server].

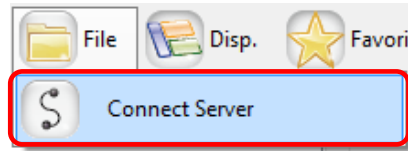

2) In the [Connect Server] dialog box, enter the IP address of the destination to connect and click [Connect].

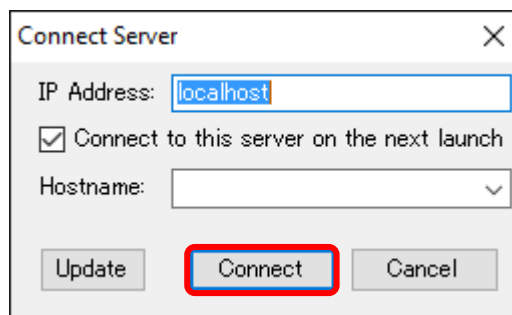

3) The main screen displays a graph of the specified summary data DB.

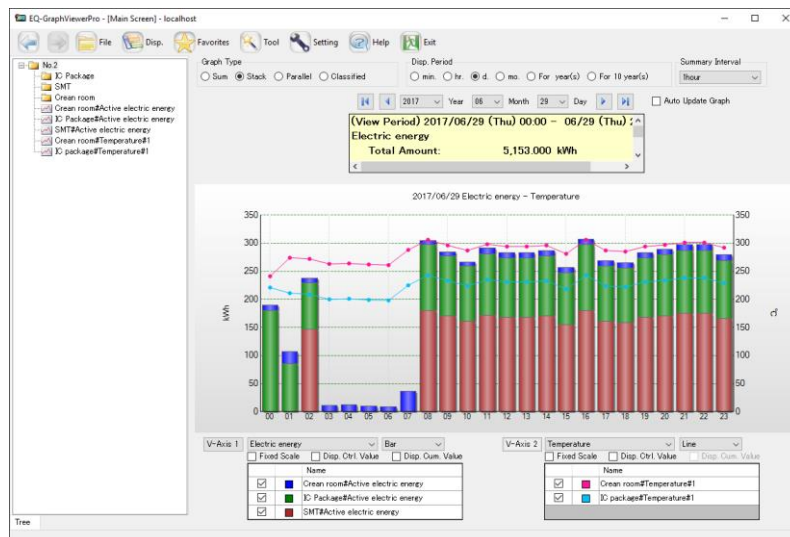

10.3. Selecting a Channel Group to Display

Click and select a channel group for a graph display from the channel tree area on the left of the main screen. Channel groups are displayed as folder icons.

■ Showing/Hiding Channel Tree Area

If the channel tree area is not displayed, on the toolbar click [Disp.] and select the [Disp. Channel Tree] check box.

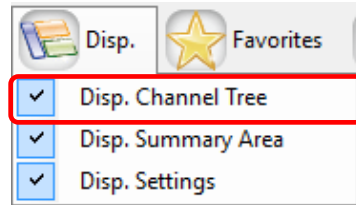

This operation switches showing/hiding the channel tree area.

■ Deploying/Undeploying a Channel

A channel view can be deployed and undeployed.

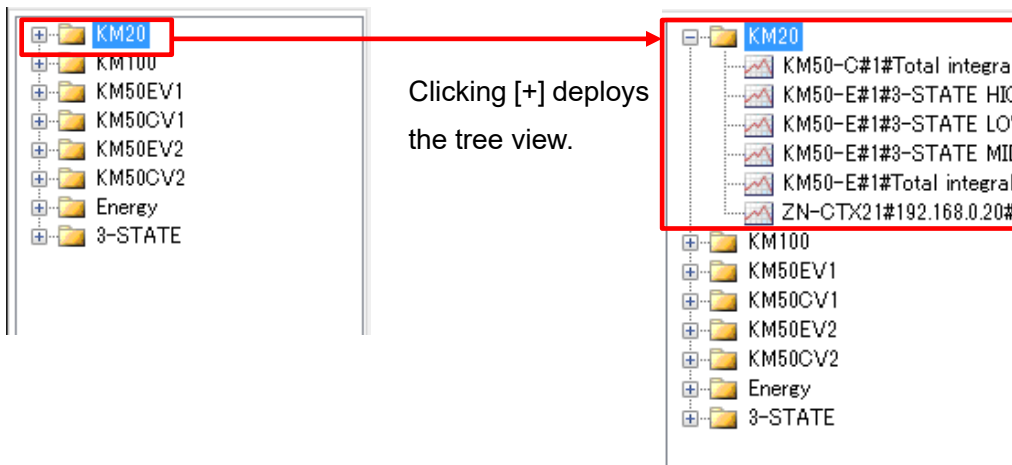

■ Hiding a Channel Name

You can hide channel names belonging to a channel group.

1) On the toolbar, click [Setting].

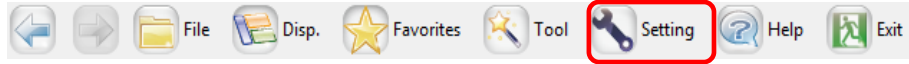

2) In the [Setting] dialog box, clear the [Channel] dialog box of [Tree Area] in [Display Setting] field. Clicking [OK] hides channel names in the channel tree.

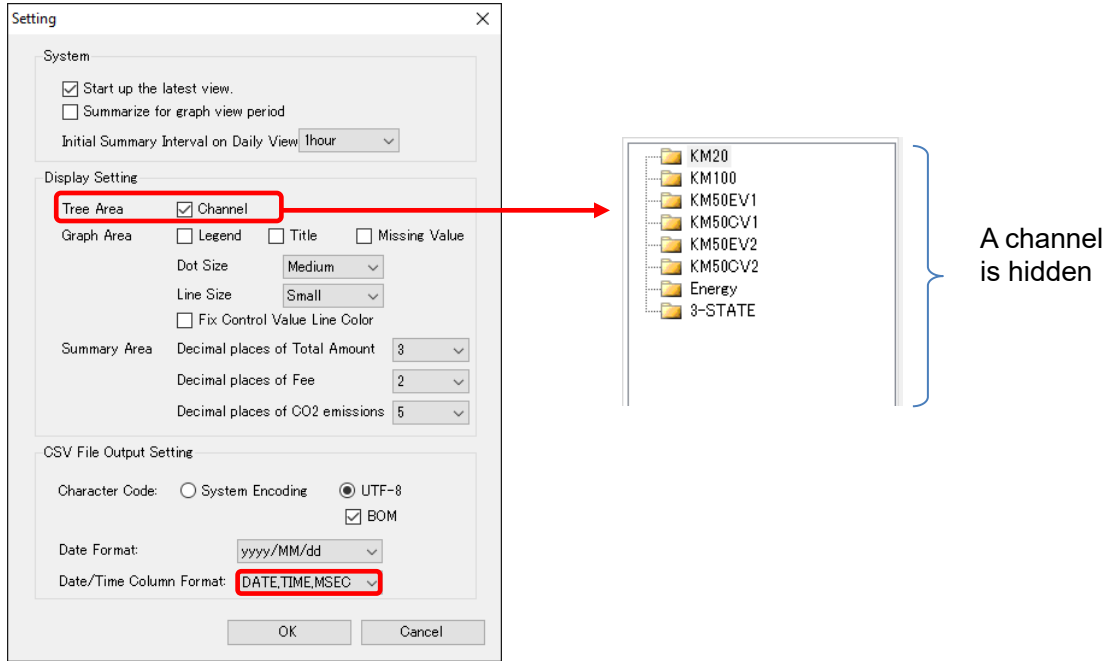

■ Checking a Belonging Channel

On the [Check Belonging Channels] screen, you can view a list of channels belonging to a channel group.

1) Right-click a channel group in the channel tree area, and select [Confirm Channels].

2) The [Check Belonging Channels] screen appears.

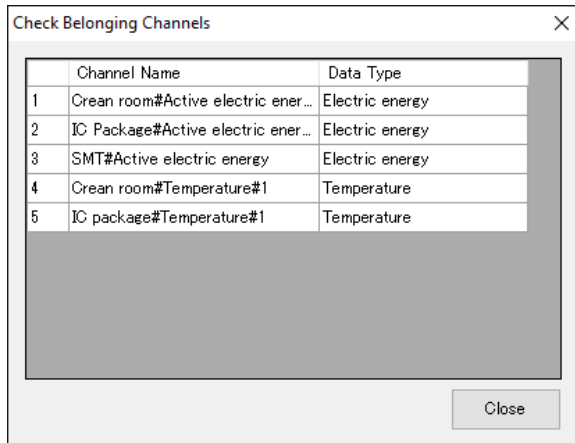

10.4. Configuring Graph View

To configure graph view settings, use the main screen.

The screenshot shows the main configuration interface of EQ-GraphViewer. It includes several numbered callouts (1-11) pointing to specific UI elements:

- 1:** Graph Type settings (Sum, Stack, Parallel, Classified).
- 2:** Disp. Period settings (min., hr., d., mo., For year(s), For 10 year(s)).
- 3:** Summary Interval dropdown (1hour).
- 4:** Date/Time selection (Year: 2017, Month: 06, Day: 29) and Auto Update Graph checkbox.
- 5:** Summary box for 'Electric energy' showing 'Total Amount: 5,153.000 kWh'.
- 6:** The main graph area showing a combined bar and line chart for '2017/06/29 Electric energy - Temperature'.
- 7:** V-Axis 1 settings (Electric energy, Bar).
- 8:** Fixed Scale check box for V-Axis 1.
- 9:** Disp. Ctrl. Value check box for V-Axis 1.
- 10:** Disp. Cum. Value check box for V-Axis 1.
- 11:** Channel selection list for V-Axis 1 (Crean room#Active electric energy, IC Package#Active electric energy, SMT#Active electric energy).
- 8:** Fixed Scale check box for V-Axis 2.
- 9:** Disp. Ctrl. Value check box for V-Axis 2.
- 11:** Channel selection list for V-Axis 2 (Crean room#Temperature#1, IC package#Temperature#1).

No.	Item	Description
1	Graph Type Setting Area	Specify a type of a graph to draw in the graph area.
2	Disp. Period Setting Area	Specify a period of a graph to draw in the graph area.
3	Summary Interval Setting Area	Specify a unit of summary of a graph to draw in the graph area.
4	Date/Time Setting Area	Specify a date & time of a graph to draw in the graph area.
5	Summary Area	Shows summary of data being displayed, e.g. total and average values.
6	Graph Area	Shows a summary graph. You can scale up and down the horizontal axis (temporal axis) by mouse operation.
7	Data Type Setting Area	Specify a category of data to draw in the graph area for longitudinal axes 1 and 2 respectively.
8	Fixed Scale check box	Select if the scaling should be automatically changed based on data or fixed to the current one for longitudinal axes 1 and 2.
9	Disp. Ctrl. Value check box	Select if the control value should be displayed or not on the longitudinal axes 1 and 2.
10	Disp. Cum. Value check box	Switches the graph view to display the cumulative value. This option is valid only for the graph of integrated quantity.
11	Disp. Target Setting Area	Shows a list of channels in the selected channel group. Select a check box of the channel to draw a graph in the graph area.

Use the following steps to configure a graph view.

1) Select a data type

Specify a data type to view in a graph in [V-Axis 1] and [V-Axis 2] in the data type setting area.

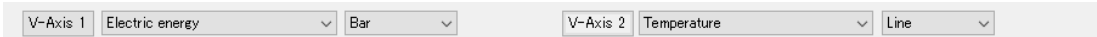

A unit of data type specified in [V-Axis 1] is displayed on the left of the graph.

A unit of data type specified in [V-Axis 2] is displayed on the right of the graph.

Reference

- The unit is specified in [Data Type Setting] in EQ-Manager.

2) Select a channel to view

In the data type setting area, a list of channels of the data type specified in [V-Axis 1] and [V-Axis 2].

Selecting the [Disp.] check box (☑) of a channel to display reflects the channel in the graph area.

		Name
<input checked="" type="checkbox"/>	■	Crean room#Active electric energy
<input checked="" type="checkbox"/>	■	IC Package#Active electric energy
<input checked="" type="checkbox"/>	■	SMT#Active electric energy

Reference

- Clicking the [V-Axis 1] or [V-Axis 2] button displays a list of graphs for respective data in the [Graph Visual Setting]. You can select a channel to view in a graph.

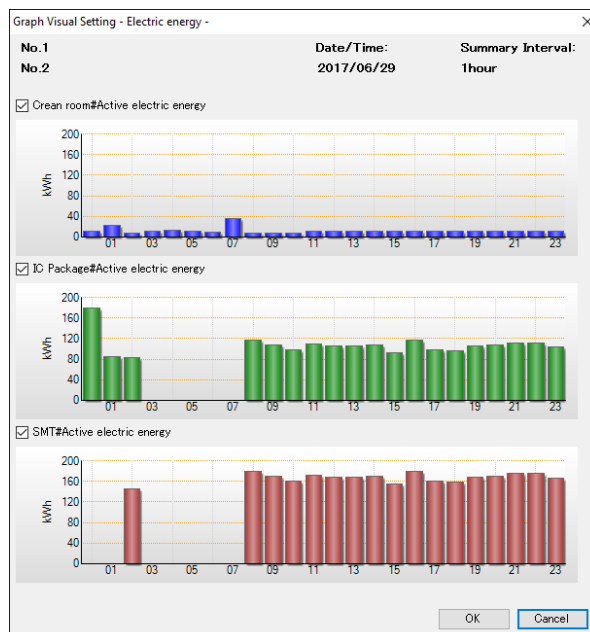

3) Select a view period

You can switch between the periods for the horizontal axis (temporal axis) of a graph in the view period setting area.

Select from six types of view periods, minute/hour/day/month/year/10 years. Selecting an item refreshes the graph.

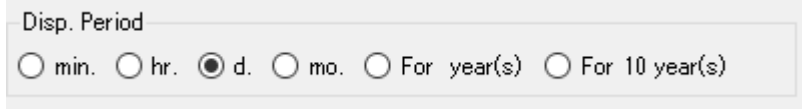

Shown below is a relation between view periods, graph horizontal scales, and displayed data:

Display Period	Horizontal Scale	Summary Interval
min.	1 minute	Not summarized
hr.	1 hour	1 minute
d.	1 day	1 min/30 min/60 min (select one)
mo.	1 month	30 min/60 min/1 day (select one)
For year(s)	1 year	1 day/1 month (select one)
For 10 year(s)	10 years	1 month/1 year (select one)

4) Select a view unit (summary interval)

Specify a time unit (summary interval) to view a graph in the summary interval setting area.

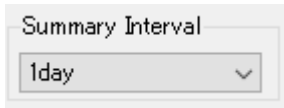

Available summary intervals depend on the setting of view period in the step 3).

5) Specify a view date & time

Specify a date and time of data to view a graph in the date/time setting area. You can specify a date/time within a range of measurement periods of all channels. When you specify a date/time out of the measurement period of the displayed channel, the graph is not displayed. Available display units depend on the setting of view period in the step (3).



Direct Input Field

Shown below are the functions:

Button/Box	Function
	Shows data with the oldest date and time among the periods of the channels.
	Specify data of the previous period by one, selected in the view period setting area.
Direct Input Field	Directly specify a value of year/month/day/time.
	Specify data of the next period by one, selected in the view period setting area.
	Shows data with the latest date and time among the periods of the channels. Data of the current hour is displayed if the EQ server is logging data.
<input type="checkbox"/> Auto Update Graph	If this check box is selected, data is acquired every 10 seconds from the EQ server that is logging data, and the graph is automatically updated. This function is not available if the EQ server is not logging data. In addition, selecting this check box disables operations of the main screen, except for this check box itself and [Disp.] and [Logging] menus.

6) Select a type of bar graph

Select a type of bar graph from four types in the graph type area, Sum/Stack/Parallel/Classified.



Shown below is overview of graph types:

Graph Type	Description
Sum graph	A graph of total value of the selected channels is displayed.
Stack graph	A stacked bar graph of the selected channels with different colors is displayed.
Parallel graph	A paralleled (side-by-side) bar graph of the selected channels is displayed.
Classified graph	A graph of electric energy of the selected channels is displayed, with classified in three statuses (3-STATE) [Operating](High), [Waiting](Middle), and [Stop](Low) as well as [Classification Unavailable], in this sequence from the top.

Reference

- Switching between graph types does not change the graph of data such as temperature, particle, and electric current viewed in a line graph.

7) Fix the scale

Select whether the scale for the axes should be automatically changed based on the viewing data or fix the scale with specified upper and lower limits.

Select the [Fixed Scale] check box in the data type setting area.

Right-click the [Fixed Scale] check box and select [Upper/Lower Scale Limit Setting]. The following [Upper/Lower Scale Limit Setting] dialog box appears.

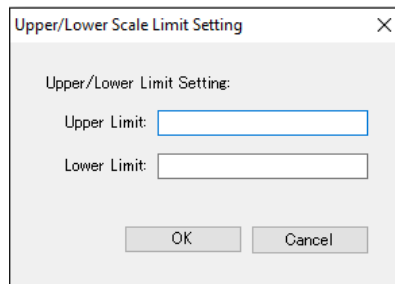

Configuring the upper and lower limits and clicking [OK] displays a graph with fixed scale of the specified upper and lower limits.

Clearing the [Fixed Scale] check box (☐) allows flexible scaling.

8) Display control values

Selecting the [Disp. Mgt. Value] check box in the data type setting area displays the control values on the graph

Reference

- A control value is specified in EQ-Manager. For details, see "7.5.5. Control Value Setting" .
- If no control value has been configured, selecting the [Disp. Mgt. Value] check box does not change the view.

9) Switching graph view (Bar/Line)

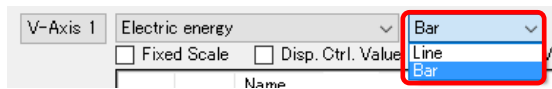

Selecting the preferred option switches the graph view between bar and line.

To view either in bar or line depends on the initial value of each data. The initial value can be changed in the EQ-Manager.

Selecting [Bar]

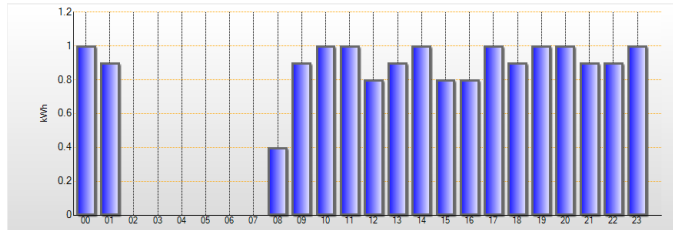

Selecting [Line]

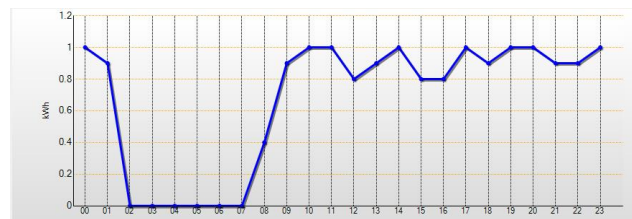

Precautions for Correct Use

- The line graph cannot view the image of stacked volume. When the integrated quantity such as electric energy or integrated flow rate is tried to be viewed in a bar graph by specifying the Graph type, Integrated, and Classified, a line graph will be selected as Sum graph.

10) Displaying cumulative value

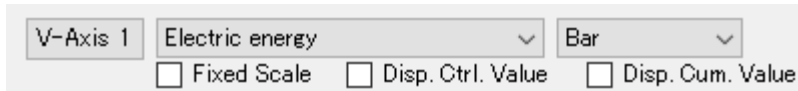

Placing a checkmark in [Disp. Cum. Value] switches to a cumulative view.

The cumulative view is available only for the integrated quantity such as electric energy or integrated flow rate.

Disp. Cum. Value

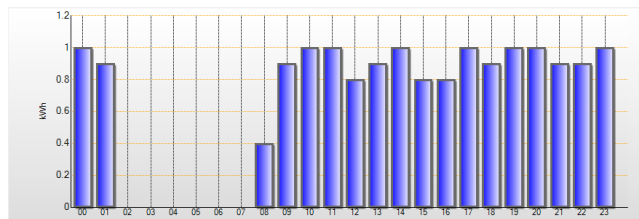

Disp. Cum. Value

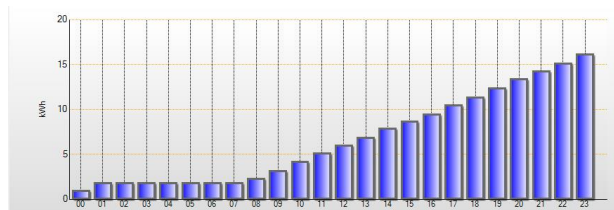

10.5. Other Operations

If necessary, perform the following operations.

10.5.1. Displaying Past Data Comparison Screen

You can compare data being displayed (source) and data of other date/time (target).

For detailed steps, see "EQ-Viewer User's Manual".

10.5.2. Displayed Graph Output

You can print out a graph image displayed on the main screen.

- Operation in the main screen

Click the [Tool] icon then select [Graph Output].

For detailed steps, see "EQ-Viewer User's Manual".

10.5.3. Displayed Data Output

You can print out a graph data displayed on the main screen.

- Operation in the main screen

Click the [Tool] icon then select [Data Output].

For detailed steps, see "EQ-Viewer User's Manual".

10.5.4. Exporting CSV File

You can output data in a CSV file.

- Operation in the main screen

A file is outputted in a report format.

Click the [Tool] icon then select [CSV File Output].

For detailed steps, see "EQ-Viewer User's Manual".

11. Safe Mode

The safe mode is for maintenance to recover an EQ100 failure.

Under the safe mode, the following operations are available:

- Checking EQ100 information
- Checking LAN/sub-LAN connection port settings
- Clearing setting/stored data
- Updating the firmware
- Clearing logs
- Recovering to the factory shipment status

11.1. Startup in Safe Mode

Shown below are the steps to start up EQ100 in the safe mode:

- 1) While the power is ON, configure the setup DIP switch SW10 of EQ100 on the front end as ON.

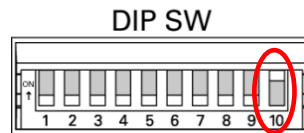

- 2) Use a very fine screwdriver or other tools to press and hold the reset button on the EQ100 front end for 1 second or longer.

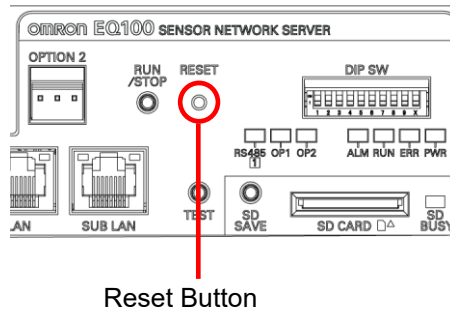

A buzzer is sounded and the power of EQ100 is turned on again, then activated under the safe mode.

Under the safe mode, the operation status indicator on the EQ100 front end flashes and stays on alternately in three second cycle.

- 3) Connect a LAN cable between the computer and the LAN connection port of EQ100. Configure the computer's IP address as shown below.

IP Address	192.168.200.***
Subnet Mask	255.255.255.0
Default Gateway	Setting not required

Precautions for Correct Use

- For "***", specify a number from 2 to 199 or from 201 to 254. You cannot use 0 and 255. Specify an IP address that is not used for EQ100 itself and measurement devices connected to the LAN connection port of EQ100.

- 4) Start up a Web browser, enter the following URL, and press Enter.
<http://192.168.200.200/>

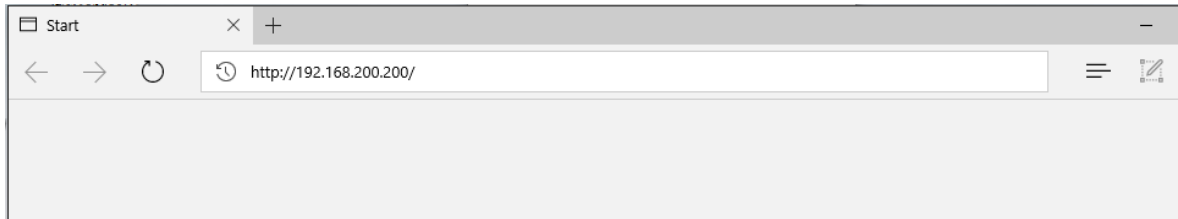

The Web UI screen of the safe mode appears.

You do not need to log in (enter ID and password).

The password "admin" is an online connection password of EQ100 upon factory shipment or after initialization. If the login password for the Web UI has been changed in [Advanced Setting] - [System Setting] - [Maintenance Screen Password Setting] of EQ-Manager, specify the new password.

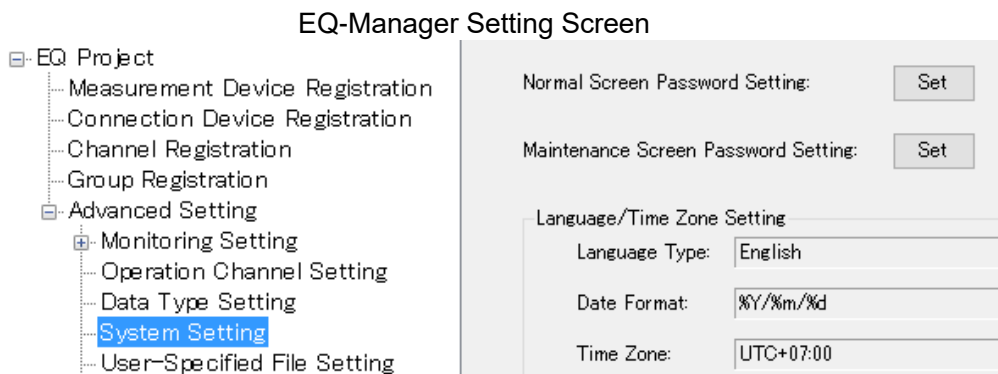

You can start up the safe mode while connecting to the EQ100 sub-LAN port.
 See below for the settings.

IP Address	192.168.100.***
Subnet Mask	255.255.255.0
Default Gateway	Setting not required

Precautions for Correct Use

- For "***", specify a number from 2 to 200 or from 202 to 254. You cannot use 0 and 25.
 Specify an IP address that is not used for EQ100 itself and measurement devices connected to the LAN connection port of EQ100.
- To connect a computer and EQ100 under the safe mode, make sure that the computer's LAN connection port should be configured so as to be connectable to 192.168.200.200 (or 192.168.100.201 for sub-LAN connection port).

11.2. Safe Mode Web UI Screen

The Web UI screen of the safe mode differs from that of the normal mode in configuration. The safe mode shows the following items.

The screenshot shows the 'Safe Mode' web interface with the following sections highlighted by red boxes and labeled on the right:

- Main Body Information:** A table with the following data:

SNC ID	9#051
Model	EQ100
Firmware Version	SNSA1.120
Safe Mode Version	SNSA1.120
Serial Number	000S133040
LAN MAC Address	00000a89feb5
Sub-LAN MAC Address	00000a89feb6
- LAN Setting:** A table with the following data:

LAN	IP Address	192.168.200.200
	Subnet Mask	255.255.255.0
	Gateway	192.168.200.1
	DNS	192.168.200.1
Sub-LAN	IP Address	192.168.100.201
	Subnet Mask	255.255.255.0
- Initial Setting:** A section with a 'Clear' button and the text 'Setting/Stored Information Clear'.
- Firmware Update:** A section with a text input field, a '参照' button, and an 'Update' button.
- Log Clear:** A section with a 'Clear' button and the text 'EQ100 log will be cleared.'
- Factory Shipment Status:** A section with an 'Initialization' button and the text 'Resets all data of EQ100 (including the firmware) to the factory shipment status.'
- Restart:** A section with a 'Restart' button and the text 'Restarts EQ100.'

●Main Body Information

Shows SNC ID, model, firmware version, safe mode version, serial number, LAN MAC address, sub-LAN MAC address of the EQ100.

●LAN Setting

Shows IP addresses and subnet masks of LAN/sub-LAN connection ports. The gateway and DNS are displayed for LAN connection port only.

●Initial Setting

Clears the following setting/stored information:

- Setup Information (information of collecting setting, monitoring setting, and advanced setting)
- Information stored in EQ100 programs (failure occurrence information, unsent emails, unsent FTP information)

●Firmware Update

Updates the firmware of the EQ100. After the firmware update, EQ100 is under the setting status and the general-purpose outputs are OFF. The operation settings of EQ100 are succeeded from those before the firmware update.

●Log Clear

Clears event logs that are not outputted to a file, as well as information stored in EQ100 programs.

●Factory Shipment Status

Resets all data of EQ100 (including the firmware) to the factory shipment status.

●Restart

Restarts EQ100.

Shown below is information to be initialized by initialization operations under the safe mode:

Yes: Initialized, No: Not initialized

	Setting/Stored Information Clear	Firmware Update	Log Clear	Factory Shipment Status
Operation Settings (EQ Project File)	Yes	No	No	Yes
Collected Data File (CSV File)	No	No	No	Yes
Event Log File (CSV File)	No	No	No	Yes
Collected Data Not Saved as File	No	Yes	No	Yes
Event Log Not Saved as File	No	Yes	Yes	Yes
Information in Programs	Yes	Yes	Yes	Yes
EQ100 Operation Status	No	Yes	No	Yes
Previous Integrated Data	No	Yes	No	Yes

Precautions for Correct Use

- When you try to open the Web UI screen for the safe mode using the Web browser that opened the Web UI screen under the normal mode, the screen may not be properly displayed. In such a case, clear the Web browser cache file. (For Internet Explorer, delete temporary internet files)

11.3. Setting/Stored Information Clear

Clears information stored in EQ100 programs (failure occurrence information, unsent emails, unsent FTP information). This does not clear collected data and event logs already outputted to internal memory or an SD card.

See below for operation steps:

- 1) Click [Clear] in the initial setting.



- 2) On the message prompting process confirmation, click [OK].

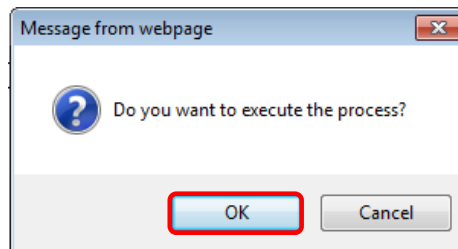

- 3) When the setting information and log data are cleared, a message indicating completion of the process appears. Click [OK].

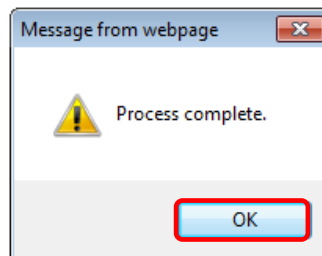

11.4. Updating the Firmware

Updates the firmware of the EQ100 to the latest one.

For the latest firmware information, visit OMRON's Web site.

<http://www.fa.omron.co.jp>

You can view the current firmware version being used on the top page of the Web UI screen under the safe mode.

See below for operation steps:

- 1) Click [Browse] in the firmware update.

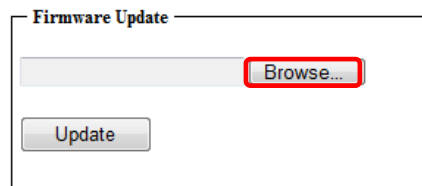

The [Choose File to Upload] dialog box appears.

- 2) Select the firmware update file (extension "dat") and click [Open].

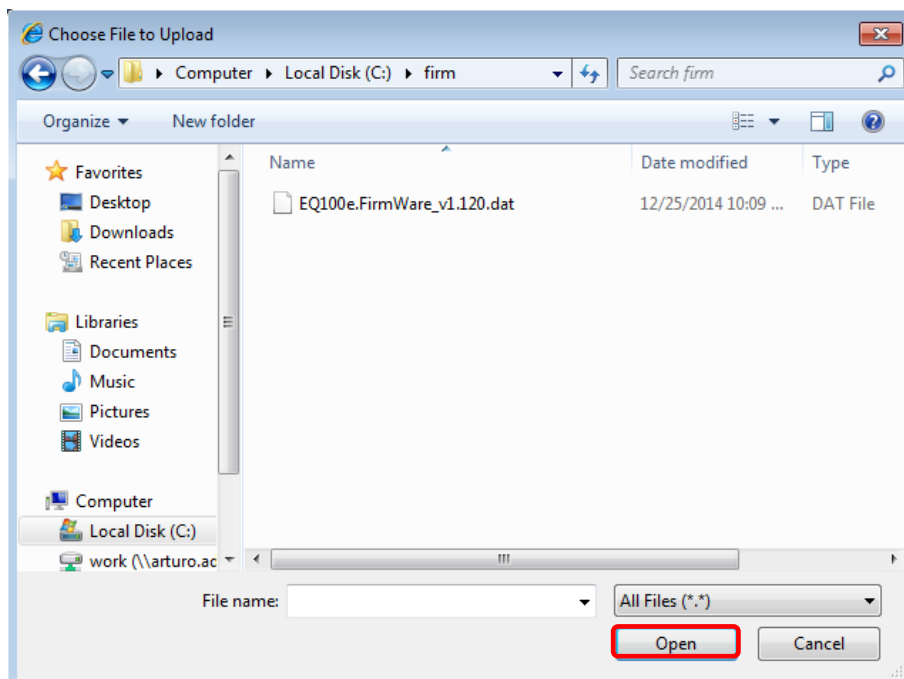

The reference directory appears in the field.

- 3) Click [Update].



- 4) On the message prompting process confirmation, click [OK].

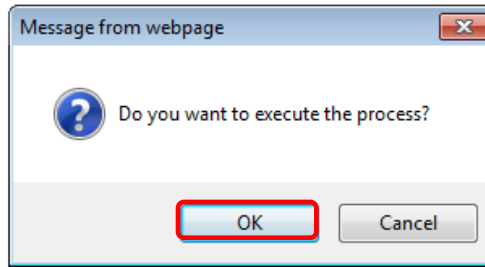

The firmware update begins. During firmware update, the progress bar (progress status) appears on the browser's task bar.

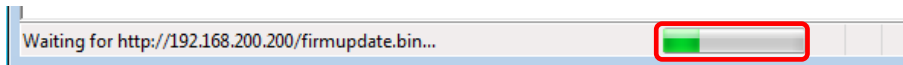

- 5) When the update is completed, a message prompting restart appears. Click [OK].

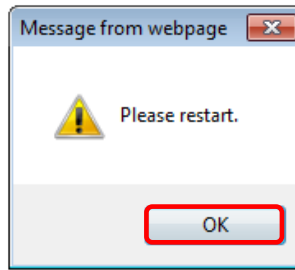

- 6) Configure the DIP switch SW10 on the EQ100 front end as OFF

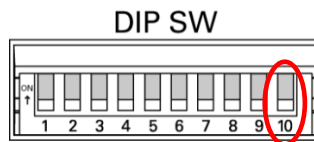

- 7) Use a fine-tipped screwdriver or other tools to press and hold the reset button on the EQ100 front end for 1 second or longer.

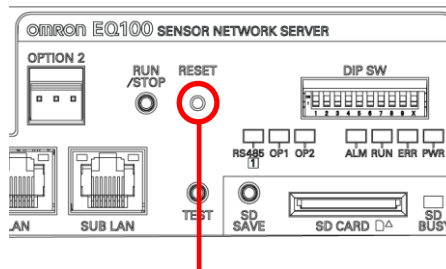

RESET Button

A buzzer is sounded and EQ100 is reset. After the restart, the updated firmware is effective.

Precautions for Correct Use

- DO NOT turn off the power of EQ100 while updating the firmware until the process is completed. Do not operate the Web UI as well. Otherwise EQ100 may not run.
- Before updating the firmware, output EQ project files as well as collected data files and event log files to the computer or an SD card.

11.5. Log Clear

Clears event logs in EQ100. The event log files that have been already output as a file are not deleted.

See below for operation steps:

- 1) Click [Clear].

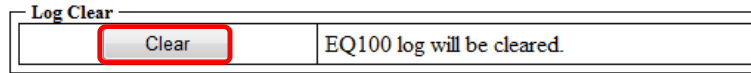

- 2) On the message prompting process confirmation, click [OK].

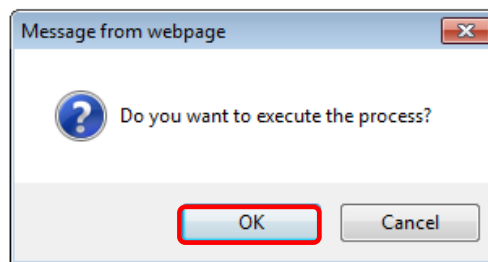

- 3) When the event logs are cleared, a message indicating completion of the process appears. Click [OK].

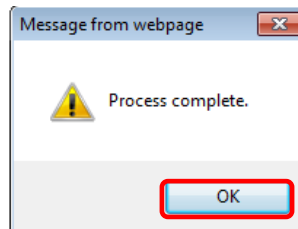

11.6. Recovering to Factory Shipment Status

Resets all data of EQ100 (including the firmware) to the factory shipment status.
See below for operation steps:

- 1) Click [Initialization] in the factory shipment status.

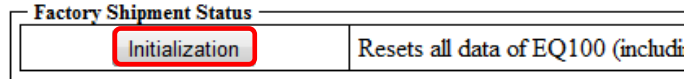

- 2) On the message prompting process confirmation, click [OK].

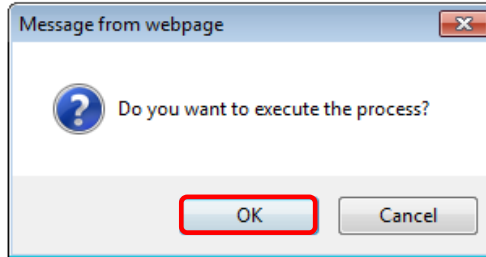

- 3) When the EQ100 is reset to the factory shipment status, a message prompting restart appears. Click [OK].



- 4) Configure the DIP switch SW10 on the EQ100 front end as OFF.

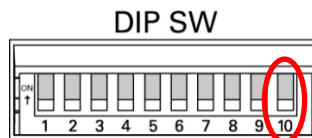

- 5) Use a very fine screwdriver or other tools to press and hold the reset button on the EQ100 front end for 1 second or longer.

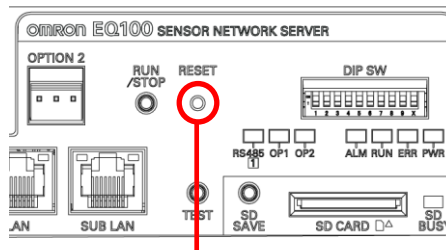

RESET Button

A buzzer is sounded and EQ100 is reset. EQ100 is started with the factory shipment status.

Precautions for Correct Use

- Before recovering to the factory shipment status, output EQ project files as well as collected data files and event log files to the computer or an SD card.

11.7. Exiting Safe Mode

To exit the safe mode and return to the normal mode, use the following steps to start up and connect.

- 1) Configure the DIP switch SW10 on the EQ100 front end as OFF.

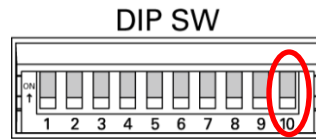

- 2) Use a very fine screwdriver or other tools to press and hold the reset button on the EQ100 front end for 1 second or longer.

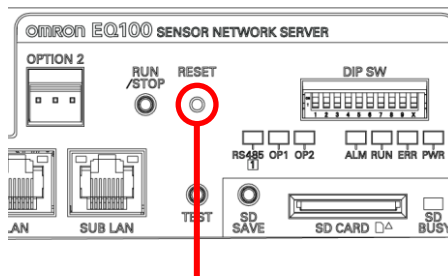

RESET Button

A buzzer is sounded and EQ100 is reset. EQ100 is started under the normal mode.

12. Appendix

12.1. Troubleshooting

Item	Action	Refer to
Cannot access the login screen	Check the LAN cable connection.	"5.5.4. LAN Connection Port"
	Check that the computer's LAN settings (IP address, subnet mask, DNS, default gateway) should match the connected LAN environment.	"9.2. Connecting from Web Browser"
	To connect to a LAN environment with DHCP for collecting, check that the IP address of EQ100 should be an available value.	"7.6.4. Configuring EQ100 LAN Connection Port/Sub-LAN Connection Port"
	Check that the URL should be correct.	"9.2. Connecting from Web Browser"
	Check that an IP address of the computer or EQ100 should not overlap the other device's address.	"9.2. Connecting from Web Browser"
	Check that the setup DIP switch SW10 should be set to OFF.	"9.2. Connecting from Web Browser"
	Check the LAN setting of the Web browser (Internet Explorer). Configure the setting so as not to use a proxy server.	"9.1.1. Operating Environment"
Cannot log in	Check the user name and password.	"9.2. Connecting from Web Browser"
Cannot access the safe mode screen	Check the 1:1 connection of the computer and EQ100 with a LAN cable.	"5.5.4. LAN Connection Port"
	Regardless of the IP address configured in an EQ project, the IP address for the safe mode is as shown below: - For LAN connection port, 192.168.200.200 (fixed). Check the URL should be http://192.168.200.200/. - For sub-LAN connection port, 192,168,100,201 (fixed). Check the URL should be http://192,168,100,201.	"11.1. Startup in Safe Mode"
	Check that the setup DIP switch SW10 should be set to ON.	"11.1. Startup in Safe Mode"
The top page of Web UI screen does not appear properly	Check that the setting of Internet Explorer 8 should not be configured as compatibility view for older versions.	"12.6. Web UI Screen on Internet Explorer 8 (IE8)"
	Erase temporary internet files of Internet Explorer.	

Item	Action	Refer to
A graph view on the Web UI screen shows a large value.	<p>Integrated data value may get large if collecting has been stopped for a long period of time due to power off or setup change.</p> <p>The integrated data can be initialized by clearing the previous value of integrated data. Note that clearing the previous value deletes the total value during the stopped period.</p>	
The device alarm indicator flashes, turns on, or turns temporarily on	Check the error details on the "event log reference" screen.	"9.9. Maintenance > System"
The device alarm indicator keeps flashing due to improper operation of SD card ejection.	<p>Writing to an SD card successfully can recover the SD card error.</p> <p>Attach an SD card to write, or stop the collecting process to clear the failure.</p> <p>Note that the output of collected data to an SD card does not erase the collected data in the internal memory. You can erase the collected data outputted on the SD card without any problem.</p>	
Failed to update EQ100 settings via an SD card	<p>Updating of EQ100 settings via an SD card may fail in the following cases:</p> <ul style="list-style-type: none"> - More than one EQ project file exists in the SD card - The EQ project file name contains " "(a space character) - No EQ project file exists under the "EQ_project" folder of the SD card, right under the root - The folder name right under the root does not comply with case sensitivity, as in "eq_project" or "EQ_PROJECT" instead of "EQ_project" - Content of the EQ project file in the SD card is illegal - The SD card is not properly attached - The SD card is write-protected 	This manual: "7.9.2. Writing EQ Project File through SD Card" EQ-Viewer User's Manual: "4.7. EQ100 Operation and Management"
Failed to write an EQ project or update the firmware through an SD card, and normal ejection operation of the SD card cannot be done	<p>When an error occurred due to an operation using an SD card, normal SD card ejection operation using the Save SD Card button may not be available occasionally.</p> <p>In such a case, set all the setting DIP switches to OFRF and press the reset button (or turn off the power and on again) to restart the EQ100.</p> <p>After the restart, perform standard SD card ejection operation to eject the SD card.</p>	

Item	Action	Refer to
Collected data cannot be outputted to an SD card	Use a computer to check that the SD card has been properly formatted.	Computer's Operation Manual
	Use a computer to check the SD card format, which must be FAT16 for SD or FAT32 for SDHC.	Computer's Operation Manual
	Check that EQ100 should be configured as "collecting status".	"9.5. Simple Graph View > Current Value Monitor"
Time synchronization by the SNTP server cannot be done	Check the LAN cable connection.	"5.5.4. LAN Connection Port"
	Check that the SNTP server name, LAN settings (IP address, subnet mask, DNS server, and default gateway) should be properly configured.	"7.6.4. Configuring EQ100 LAN Connection Port/Sub-LAN Connection Port"
	Check that the connection to the SNTP server's communications port should be permitted.	"7.6.3. EQ100 Time "
Time synchronization by the EQ server cannot be done	Check the LAN cable connection.	"5.5.4. LAN Connection Port"
	Check that the SNTP server name, LAN settings (IP address, subnet mask, DNS server, and default gateway) should be properly configured.	"7.6.4. Configuring EQ100 LAN Connection Port/Sub-LAN Connection Port"
	Check that the connection to the EQ server's communications port should be permitted.	"7.6.3. EQ100 Time "
Email notification cannot be sent	Check the LAN cable connection.	"5.5.4. LAN Connection Port"
	Check that the notification email settings (SMTP server name, port number, monitoring alarm notification email address) and LAN settings (IP address, subnet mask, DNS server, and default gateway) should be properly configured.	"7.5. EQ100 Monitoring Setting", "7.6.4. Configuring EQ100 LAN Connection Port/Sub-LAN Connection Port"
	If "email transmission error (server error)" is collected on the "event log reference" screen, check that the destination address should be correct, that addresses (if any) should be delimited by ';' (semicolon), and that the destination mail server should not deny reception.	"7.6.3. EQ100 Time "

Item	Action	Refer to
Cannot transition to the collecting status	Check that the plus and minus wiring should be correct.	"7.6.5. Configuring RS-485 Communications Port"
	Check that the RS-485 communications settings (communication speed, data length, stop bits, vertical parity) of EQ100 and measurement devices should be the same for each port.	"7.6.5. Configuring RS-485 Communications Port"
	Check that the unit numbers should not be the same for the same port.	"7.6.5. Configuring RS-485 Communications Port"
	Check that the terminal resistor should be properly connected.	"7.6.5. Configuring RS-485 Communications Port"
	Check that a channel has been registered in the EQ project.	"7.4.4. Channel Registration"
	If a LAN measurement device is connected at 10Mbps, replace the hub and/or the cable and connect at 100Mbps.	Operation Manual/User's Manual of LAN-Connected Measurement Device
Data from a measurement device connected via RS-485 are occasionally lost	Check that the hard wiring should not be branched. Connection must be chain-linked.	"7.6.5. Configuring RS-485 Communications Port"
	Check that the terminal resistor should be properly connected.	"7.6.5. Configuring RS-485 Communications Port"
Abnormal battery voltage	Check that the battery should be properly connected.	"5.2. Battery"
	Replace the battery if it has been used for years (battery life depends on the use conditions).	"5.2. Battery"
In the 10BASE-T LAN environment, firmware updating and/or setup file updating failed	In a 10BASE-T LAN environment, a communication failure may occur if a computer with Windows 7 OS is connected to EQ100. In such a case, use a hub that can convert 10BASE-T/100BASE-TX and use 100BASE-TX for a connection to the computer.	

12.1.1. Overview of Error Status Types and Actions

Error Status Types	Definition	Details	Output			Action
			Device Alarm Status Indicator	Event Log	Email Notification	
Communications Error (Collecting status Kept)	A communications error occurred under the collecting status. The collecting status is kept.	Email transmission error, NTP server connection failure, EQ server connection failure	Temporary On	Yes	Yes	Check that the communications settings and the server.
Device Error (Collecting status Kept)	A failure of an EQ100 peripheral device. The collecting status is kept.	Battery not attached or low battery, LAN connection error, sub-LAN connection error, input pulse failure, abnormal internal temperature, SD card error (including SD card not attached)	Flashing	Yes	Yes (No for LAN connection error)	Check the battery connection, LAN cable connection, ambient temperature, SD card insertion and capacity.
Monitoring Process Error (Collecting status Kept)	A status under which normal monitoring process is not available due to a failure in the collecting status. The collecting status is kept.	Data collecting rate lowered, collected data lost, data transfer error, time synchronization error, SD write failure continued, email transmission error continued, monitoring failure occurred	Long flashing	Yes	Yes	Check the target device status, SD card, and communications settings.
Setup/status failure (transition to setup status)	EQ100 cannot start or continue the collecting status. The status transitions to the setup status.	Abnormal setup data, internal parameter error, clock failure	Flashing	Yes	No	Please contact OMRON.
Instrument Failure	A fatal error: EQ100 cannot be started or its operation cannot be continued.	CPU runaway detected, abnormal program data, device error, instrument failure occurred	On	Yes	Yes	Please contact OMRON.

12.1.2. Event Log Code List

Error Status Types	Log Code	Operation Status Indication	Action	EQ100 Operation	Clearing of Failure Status upon Setting Change	Device Alarm Status Indicator	Event Log	Email Notification	Delayed Notification (*1)
Instrument Failure	-	CPU runaway detected	No	Restart by forced reset by hardware	-	-	No	No	No
	-	Abnormal program data	No	Startup in safety mode	-	-	No	No	No
	-	Device error	No	System Error Status	-	-	No	No	No
	01	Instrument failure occurred	No	System Error Status	-	On (*2)	Yes	No	No
	02								
	03								
	04								
	05								
06									
07									
08									
Setting/Status Error	10	Abnormal Setup Data	Check the settings.	Setup status continued. Waiting for a change of settings in the setup in which most recently the system ran properly.	No	Flashing	Yes	No	No
	12	Internal Parameter Error	On the safe mode screen, clear the setup and stored information.	Internal parameters are recovered and the system is started up (Startup may not be available depending on the corrupt status)	No	-	Yes	No	No
	16	Clock Failure	No	Collecting is paused (setup status) and resumed (without device communications check)	Yes	-	Yes	Yes	Yes
Device Error	2B	LAN Connection Error Occurred	Connect a LAN cable to the port indicated as "LAN"	Process is continued while waiting for recovery	Yes	Flashing	Yes	No	No
	2C	LAN Connection Error Recovered	No	Process continued	-	Off	Yes	No	No
	30	Abnormal Battery Voltage Occurred	Open the top cover and replace the battery within 5 minutes	Process is continued while waiting for recovery (occurred status is kept even after the setting is changed)	No	Flashing	Yes	Yes	Yes

Error Status Types	Log Code	Operation Status Indication	Action	EQ100 Operation	Clearing of Failure Status upon Setting Change	Device Alarm Status Indicator	Event Log	Email Notification	Delayed Notification (*1)
	31	Battery Voltage Error Recovered	No	Process continued	-	Off	Yes	No	No
	33	Internal Temperature Error Occurred	Check the ambient temperature that it should be within a range from -10 to 55°C	Process is continued while waiting for recovery (occurred status is kept even after the setting is changed)	No	Flashing	Yes	Yes	Yes
	34	Internal Temperature Error Occurred	Check the ambient temperature that it should be within a range from -10 to 55°C	Process is continued while waiting for recovery (occurred status is kept even after the setting is changed)	No	Flashing	Yes	Yes	Yes
	35	Internal Temperature Error Recovered	No	Process continued	-	Off	Yes	Yes	Yes
	3A	SD Card Error Occurred (No Card)	Insert an SD Card	Process is continued while waiting for recovery	Yes	Flashing	Yes	Yes	Yes
	3B	SD Card Error Occurred (Free Space)	Check the remaining capacity of the SD card and insert an SD card with a required free space	Process is continued while waiting for recovery	Yes	Flashing	Yes	Yes	Yes
	3C	SD Card Error Occurred (Locked)	Unlock the SD card protection and insert	Process is continued while waiting for recovery	Yes	Flashing	Yes	Yes	Yes
	3D	SD Card Error Recovered	No	Process continued	-	Off	Yes	Yes	Yes
	50	Sub-LAN Connection Error Occurred	Connect a LAN cable to the port indicated as "SUB LAN"	Process is continued while waiting for recovery	Yes	Flashing	Yes	Yes	No
	51	Sub-LAN Connection Error Recovered	No	Process continued	-	Off	Yes	Yes	Yes

Error Status Types	Log Code	Operation Status Indication	Action	EQ100 Operation	Clearing of Failure Status upon Setting Change	Device Alarm Status Indicator	Event Log	Email Notification	Delayed Notification (*1)
Communications Error	67	Email Transmission Error Occurred	Check the notification settings	Process is continued while waiting for recovery. For an item with delayed notification available, up to 32 items are retained and sent at the next email transmission timing.	Yes	Temporary Flashing	Yes	No	No
	68	Email Transmission Error Recovered	No	Process continued	-	Off	Yes	No	No
	69	Email Transmission Error (Server Error)	Check the notification settings	Process stopped, without redelivery	Yes	Temporary Flashing	Yes	No	No
	6A	SNTP Server Connection Not Available	Check the SNTP server settings	Process is continued while waiting for recovery	Yes	Temporary Flashing	Yes	No	No
	6B	SNTP Server Connection Recovered	No	Process continued	-	Off	Yes	No	No
	70	EQ Server (Time Synchronization) Connection Not Available	Check the EQ server settings	Process is continued while waiting for recovery	Yes	Temporary Flashing	Yes	No	No
	71	EQ Server (Time Synchronization) Connection Recovered	No	Process continued	-	Off	Yes	No	No
Operation History	90	Start Collecting	No	-	Yes	-	Yes	No	No
	91	Collecting Stopped	No	-	Yes	-	Yes	No	No
	92	New Registration/ Update of Settings	No	-	Yes	-	Yes	No	No
	93	Power Cut Detected Under Monitoring	No	Process before power cut (saving time and previous integrated value, etc)	Yes	-	No	No	No
	94	Power Cut Under Collecting Occurred/	No	Collecting is started after the process after power cut	-	-	Yes	Yes	Yes

Error Status Types	Log Code	Operation Status Indication	Action	EQ100 Operation	Clearing of Failure Status upon Setting Change	Device Alarm Status Indicator	Event Log	Email Notification	Delayed Notification (*1)
		Recovered		(saving time and previous integrated value, etc)					
	95	Data Missing at Preparing Collecting	No	-	--	--	Yes	No	No
	96	New Registration/Update of Settings (Failed)	Make sure that the update file should be an EQ project file. For performing the operation via an SD card, see "7.9.2. Writing EQ Project File through SD Card" in this document.	-	-	Flashing	Yes	No	No
	9A	Normal startup complete	No	-	-	-	-	-	
	9B	Restarting & Recovering	No	-	-	-	-	-	
Collecting Process Error	A0	Data collecting Rate Lowered	Check the operation and settings of the sensor that cannot measure data on the current value monitoring screen.	Process is continued while waiting for recovery	Yes	Flashing	Yes	Yes	Yes
	A1	Data collecting Rate Recovered	No	Process continued	-	Off	Yes	Yes	Yes
	A2	Measured Data Missing Occurred	Check that the power of the sensor should be on. If the problem cannot be solved yet, check the sensor communications and resume collecting.	Process is continued while waiting for recovery	Yes	Flashing	Yes	Yes	No
	A3	Measured Data Missing Recovered	No	Process continued	-	-	Yes	Yes	No
	A5	Data Transfer Error Continued	Check the FTP transmission settings.	Process is continued while waiting for recovery	Yes	Flashing	Yes	Yes	Yes
	A6	Data Transfer Error Recovered	No	Process continued	-	-	Yes	Yes	Yes
	A8	Time Synchronization Error Occurred	Check the time synchronization settings.	Process is continued while waiting for recovery	Yes	Flashing	Yes	Yes	Yes
	A9	Time	No		-	-	Yes	Yes	Yes

Error Status Types	Log Code	Operation Status Indication	Action	EQ100 Operation	Clearing of Failure Status upon Setting Change	Device Alarm Status Indicator	Event Log	Email Notification	Delayed Notification (*1)
		Synchronization Error Recovered							
	AB	SD Card Write Error Continued	Check the SD card	Process is continued while waiting for recovery.	Yes	Flashing	Yes	Yes	Yes
	AC	SD Card Write Error Recovered	No		-	-	Yes	Yes	Yes
	AE	Email Transmission Error Continued	Check the notification settings	Process is continued while waiting for recovery For an item with delayed notification available, up to 32 items are retained and sent at the next email transmission timing.	Yes	Flashing	Yes	Yes	Yes
	AF	Email Transmission Error Recovered	No	Process continued	-	-	Yes	Yes	Yes
	B0	Collecting Failure Occurred (Time Synchronization)	Solve the time synchronization error.	The collecting status is kept.	Yes	Flashing	Yes	Yes	Yes
	B1	Collecting Failure Occurred (Data Transfer)	Solve the data transfer error (FTP transmission).	The collecting status is kept. Old data are overwritten and new data are saved	Yes	Flashing	Yes	Yes	Yes
	B2	Collecting Failure Occurred (SD)	Solve the SD card error	Process is continued while waiting for recovery. Old data are overwritten and new data are saved	Yes	Flashing	Yes	Yes	Yes
	B3	Collecting Failure Recovered	No	Process continued	-	-	Yes	Yes	Yes
Warning	C0	Low on SD Card Free Space	A free space of the SD card is low. Replace the SD card.	Process is continued while waiting for recovery	Yes	Flashing	Yes	Yes	Yes
	C1	Low on SD Card Free Space Recovered	No	Process continued	-	-	Yes	Yes	Yes

*1: If "Yes", an email notification is resent when failed.

*2: The device alarm indicator may not turn on.

12.2. Subjective Operation Guide

12.2.1. Setting for EQ100

How do I	Operation	Refer to
Create a new setup data project?	On EQ-Manager, select [File] menu - [Create] - [EQ Project]	This manual: "7.2. Creating New EQ Project" EQ-Viewer User's Manual: "4.6 Creating EQ100 Project"
Register a measurement device to connect?	On EQ-Manager, select [Measurement Device Registration]	This manual: "7.4.3. Measurement Device Registration"
Configure a collecting interval for each measurement device?	On EQ-Manager, specify "collecting interval" for each measurement device	EQ-Viewer User's Manual: "4.6 Creating EQ100 Project"
Specify a measurement channel to collect for a registered measurement device?	On EQ-Manager, select [Channel Registration]	This manual: "7.4.4. Channel Registration" EQ-Viewer User's Manual: "4.6 Creating EQ100 Project"
Measure pulse inputs to EQ100 as a measurement channel?	On EQ-Manager, select [Measurement Device Registration] to register "EQ100 PULSE" Convert the value through a created operation channel	This manual: "7.4.3. Measurement Device Registration" EQ-Viewer User's Manual: "4.6 Creating EQ100 Project"
Calculate a basic unit as a measurement channel?	On EQ-Manager, select [Advanced Setting] - [Operation Channel Registration] - [Basic Unit Channel]	This manual: "7.4.5. Operation Channel Setting"
Perform an arithmetic operation of a measurement channel to create another virtual measurement channel?	On EQ-Manager, select [Advanced Setting] - [Operation Channel Registration] - [Operation Channel]	EQ-Viewer User's Manual: "4.6 Creating EQ100 Project"
Configure monitoring settings for monitoring alarm?	On EQ-Manager, select [Monitoring Setting]	This manual: "7.5. EQ100 Monitoring Setting" EQ-Viewer User's Manual: "4.6 Creating EQ100 Project"
Output monitoring alarm contact?	On EQ-Manager, select [Control Value Setting]	This manual: "7.5.5. Control Value Setting"
Specify a day of the week/hour to output monitoring alarm email?	On EQ-Manager, select [Notification Setting]	"7.5.6. Notification Setting" EQ-Viewer User's Manual: "4.6 Creating EQ100 Project"
Configure an IP address of EQ100 LAN connection port? Change the factory shipment IP address "192.168.200.200" of EQ100?	On EQ-Manager, select [EQ Project] - [EQ100 Network Setting](LAN) and configure an IP address	This manual: "7.6.4. Configuring EQ100 LAN Connection Port/Sub-LAN Connection Port" EQ-Viewer User's Manual: "4.6 Creating EQ100 Project"
Configure an IP address of EQ100 sub-LAN connection port? Change the factory shipment IP address "192,168,100,201" of EQ100?	On EQ-Manager, select [EQ Project] - [Network Setting] - [EQ100 Network Setting](Sub-LAN) and configure an IP address	This manual: "7.6.4. Configuring EQ100 LAN Connection Port/Sub-LAN Connection Port" EQ-Viewer User's Manual: "4.6 Creating EQ100 Project"

How do I	Operation	Refer to
Set up a password for access to the Web UI screen?	On EQ-Manager, select [Advanced Setting] - [System Setting] to change	This manual: "7.6.6. Changing Password for Access from Web UI Function" EQ-Viewer User's Manual: "4.6 Creating EQ100 Project"
Add or change a measurement device and start collecting?	Collecting Stopped On EQ-Manager, modify the EQ project and write to EQ100 Add a new measurement device or change the connection Perform communication test Start collecting	This manual: "7. EQ100 Settings", "8. Communication Test and Collecting Start" EQ-Viewer User's Manual: "4.6 Creating EQ100 Project", "4.7 EQ100 Operations"
Add or change a measurement device newly supported by EQ-Manager and start collecting?	Update EQ-Manager and perform the above steps	

12.2.2. Taking Out EQ100 Collected Data

How do I	Operation	Refer to
Write from an SD card?	Configure the setup DIP switch SW7=ON on the EQ100 front end, insert an SD card, and reset or turn on the power	This manual: "7.9.2. Writing EQ Project File through SD Card" EQ-Viewer User's Manual: "4.7 EQ100 Operations"
Write from a computer?	Connect online from EQ-Manager, select [Write Setting], or use the Web UI screen to select [Update] - [Read EQ Project]	This manual: "7.9.2. Writing EQ Project File through SD Card" EQ-Viewer User's Manual: "4.7 EQ100 Operations"

12.2.3. EQ100 Operation

How do I	Operation	Refer to
Start communication test?	Use the Web UI to start communication test or use EQ-Manager to switch to communication test (select [Logger] menu - [Start Test])	This manual: "8.3. Communication Test Operation by Web UI screen", "8.2. Communication Test Operation by EQ-Manager" EQ-Viewer User's Manual: "4.7 EQ100 Operations"
Start collecting and logging?	Either press the RUN/STOP button on the EQ100 front end, use the Web UI to start collecting, or use EQ-Manager to start collecting (select [Logger] menu - [Start Logging])	This manual: "8.4. Start "
View the collecting status?	Status of Each Measurement Device	Use EQ-Manager to connect online and select [Operation Monitor]
	Status of Each Measurement Channel	On the Web UI screen, select [Current Value Monitor]
Inhibit collecting start by the RUN/STOP button on the EQ100 front end?	Configure the DIP switch SW9 as ON on the EQ100 front end	This manual: "2.1.3. Button"
Start up in the safe mode?	Configure the DIP switch SW10 as ON on the EQ100 front end, and reset or turn on the power	This manual: "11.1. Startup in Safe Mode"
Clear the previous value in EQ100?	On the Web UI screen, select [Update] - [Clear Previous Electric Energy]	This manual: "9.13. Maintenance > Update"
Update an EQ100 project file?	On the Web UI screen, select [Update] - [Read EQ project]	This manual: "9.13. Maintenance > Update"
Update the EQ100 firmware?	On the Web UI screen, select [Update] - [Firmware Update], or under the safe mode select [Firmware Update] on the Web UI screen	This manual: "9.13. Maintenance > Update", "11.4. Updating the Firmware"

12.2.4. Taking Out EQ100 Collected Data

How do I		Operation	Refer to
Using Web UI function	View current values or simple graph of data collected from measurement devices by EQ100 on the Web UI screen?	Connect a computer to the LAN or sub-LAN connection port of EQ100 (2) In the URL field, enter the IP address of the EQ100 LAN or sub-LAN connection port to which the Web UI computer is connected ID (fixed): admin Password: admin (initial value) (3) Select [Current Value Monitor] or [Display Graph]	This manual: "9.2. Connecting from Web Browser", "9.5. Simple Graph View > Current Value Monitor", "9.6. Simple Graph View > Graph View"
	Acquire and save data collected from measurement devices by EQ100 on the Web UI screen with a duration specified?	(1) Connect a computer to the LAN or sub-LAN connection port of EQ100 (2) In the URL field, enter the IP address of the EQ100 LAN or sub-LAN connection port to which the Web UI computer is connected ID (fixed): admin Password: admin (initial value) (3) Select [Maintenance] - [Data Acquisition] menu, specify a duration and others, and run [Acquire]	
Using EQ-GraphViewer	Use a computer (EQ-GraphViewer) to read data collected from measurement devices by EQ100 via LAN?	Use EQ-Manager to create an "EQ Server Project" In [Collecting Setting] add a target EQ100, and specify "IP address" and "collecting interval" Write the configured "EQ server project" to the EQ server For EQ-Manager: Start collecting (select [Logger] menu - [Start Logging])	This manual: "10. Viewing/Analyzing Graph on EQ-GraphViewer" EQ-Viewer User's Manual: "EQ Server Project Creation", "EQ Server Operation and Management"
Using SD Card	Save collected data file (CSV file) in an SD card attached to EQ100	Using SD Card	This manual: "7.7.3. SD Card Output Setting", "2.1.3. Button", "9.9. Maintenance > System"
	automatically?	Pressing the SD card save button (for 1 sec to less than 5 sec), or select [Maintenance] – [System] – [SD Card Data Output Setting]	
	manually?		

How do I		Operation	Refer to
Using FTP Function	Use FTP client software to fetch collected data files/event log files (hourly) in the EQ100 internal memory or collected data files (daily) in the SD card attached to EQ100?	On EQ-Manager, select [Advanced Setting] - [Network Setting] - [FTP Server Setting]	This manual: "7.7.4. FTP Server Setting" EQ-Viewer User's Manual: "4.6 EQ100 Project Creation"
	Send collected data files (hourly) in the EQ100 internal memory to an FTP server once a day in a specified hour.	On EQ-Manager, select [Advanced Setting] - [Network Setting] - [FTP Transfer Setting]	This manual: "7.7.5. FTP Transfer of Collected Data" EQ-Viewer User's Manual: "4.6 EQ100 Project Creation"

12.3. FAQ (Frequently Asked Questions)

Shown below are frequently asked questions and answers:

Item	Question	Answer
Device Connection	How many RS-485-connected measurement devices can be connected?	Up to 31 devices for one RS-485 communications port. Total 124 devices at maximum.
	How many LAN-connected measurement devices can be connected?	Up to 100 devices.
	How many wireless devices can be connected?	Up to 30 devices. To connect more than 30 wireless devices, a user must evaluate the connections before connecting them.
	How many PLCs can be connected?	Up to 10 devices.(*1)
	Are there any limitations on data collecting from PLC?	- Data with memory area of CIO, DM, and EM can be collected from PLC. Only those of Bank 0 are included. - If either "Operation Stop Error" or "Operation Continuation Error" occurred in PLC's CPU unit, EQ100 does not perform logging from the PLC. On the EQ-Manager operation monitor, "Error" is displayed. * An error due to operation continuation failure does not occur for EQ100 of the firmware version 1.160 or later.
SD Card	Is an SD card required to save collected data?	Not necessarily but an SDHC card is recommended to save collected data for larger capacity. The memory of the EQ100 can store collected data for only 1 week.
	Are SD cards separately required for collected data and settings?	No. You can use one SD card for them.
	Are multiple SD cards required to configure multiple EQ100s?	No. You can use one SD card for multiple EQ100s by rewriting EQ project in the SD card.
	Can an SDXC card be used?	No. The exFAT format is not supported.
Web UI Function	Only Internet Explorer 8/9/10/11(*2) are the supported browsers? Can other browser view the Web UI screen?	Other browser may view the screen but are not guaranteed. Other browser than those supported must be used under the customer's own responsibility.
	Can the number of general user accounts be increased to view the Web UI screen?	No. Please use the same account for simultaneous access.
	Are data on the SD card included in the graph view?	Yes. Note that only the data of devices registered to the EQ project can be viewed.
	Is a Web browser plug-in required?	No.

Item	Question	Answer
EQ Project (EQ100 Setting)	Is there any problem if a project name of an EQ project is in Japanese?	No problem.
	Which should I choose for time synchronization, SNTP or EQ server?	EQ server is recommended. For a configuration that does not use an EQ server, such as a standalone configuration, you can choose an SNTP server.
	Is an SMTP server for email transmission setting OMRON's SMTP server?	The SMTP server must be provided by the customer.
	How many channels can be registered if RS-485- and LAN-connected measurement devices exist?	Maximum number of channels is 500. For example, after registering 160 channels for RS-485-connected devices, you can register up to 340 channels for other connection devices.
File Output	Can collected data files for one day be outputted together?	Yes. Use the Web UI function, [Data Acquisition] menu. Note that file output on a daily basis is not available for an SD card attached to EQ100. One collected data file is outputted to an SD card once an hour.
	How many event logs can be viewed?	Up to 640 logs. When exceeded, older logs are overwritten by new ones, from the oldest one. Outputted event log files are not overwritten. Use the Web UI operation to output event log files if necessary.

*1: Make sure that the 4th octets of IP addresses are unique when multiple PLCs are connected, including EQ100's LAN connection port.

* The 4th octet of an IP address is, for example, xxx of 192.168.250.xxx.

*2: Supported Internet Explorer version differs depending on EQ100 firmware version. See "9.1.1 Operating Environment".

12.4. Adding/Deleting Measurement Device

This section describes an EQ project and Web UI screen graph view for adding/deleting a measurement device.

As an example, assume data collecting with an EQ100 connected to measurement devices (1), (2), and (3) (an SD card is attached to the SD card slot and the SD card output function is enabled).

Duration		A	B	C
Measurement Device (1)		→		Delete
Measurement Device (2)		→		
Measurement Device (3)		Add	→	
EQ Project		1+2	1+2+3	2+3
Web UI Graph View	Measurement Device (1)	Yes	Yes	N/A
	Measurement Device (2)	Yes	Yes	Yes
	Measurement Device (3)	N/A	Yes	Yes

■Duration A

Measurement devices (1) and (2) are connected to EQ100

Channels for measurement devices (1) and (2) are registered to the EQ project

■Duration B

A new measurement device (3) is added to EQ100

The EQ project is modified to add a channel for the new measurement device (3)

■Duration C

Measurement device (1) fails and is disconnected from EQ100

The EQ project is modified to delete the channel for the measurement device (1)

When a graph view is displayed on the Web UI screen:

- In the duration A, a graph for each channel of the measurement devices (1) and (2) can be viewed.
- In the duration B, a graph for each channel of the measurement devices (1) to (3) can be viewed. Note that value of the channel for the measurement device (3) is 0 if the view duration includes the duration A.
- In the duration C, a graph for the channel of the measurement device (1) cannot be viewed. A graph for each channel of the measurement devices (2) and (3) can be viewed. Note that value of the channel for the measurement device (3) is 0 if the view duration includes the duration A.

Reference

- In the duration C, data collecting is available with the EQ project for the duration B. Although communication timeout occurs at every collecting and device alarm indicator turns on, as the measurement device (1) is not connected.
- If the EQ project for the duration B is saved and later loaded for the duration C, a graph of the channel of the measurement device (1) can be viewed.

As described above, only the channels that are registered to the EQ project can be viewed on the Web UI screen. A graph cannot be viewed for a channel for which collected data are saved in EQ100 but which is not registered to the EQ project.

12.4.1. Failure and Replacement of Measurement Device

When a measurement device is replaced due to a failure, measured data before the failure can be migrated by using a measurement device with the same model as that of the failed measurement device. In such a case, you do not need to register a new measurement device to the EQ project.

Note that the settings of the measurement devices failed and to be replaced must be the same.

Precautions for Correct Use

- If integrated values are measured, always clear the previous values of integrated data before starting data collecting. Otherwise integrated data cannot be properly acquired right after starting the collecting.

12.4.2. Support for New Measurement Device

To use a measurement device for EQ100, use the latest EQ-Manager.

For the latest EQ-Manager and support for measurement devices, see OMRON's site:

<http://www.fa.omron.co.jp/>

12.5. Impact of Time Synchronization on Collected Data

Changing EQ100 time may affect collected data in the EQ100.

■ Changing the time from current to past

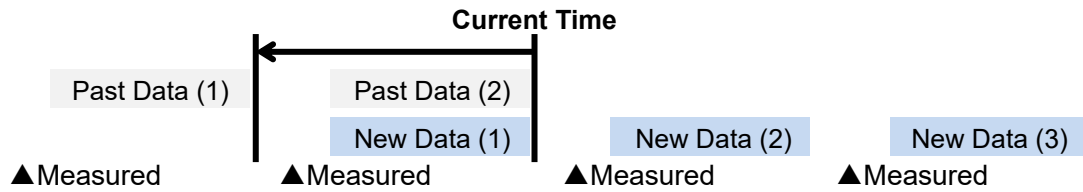

If the time is changed from current to past while past data (1) and (2) are stored, the past data (2) is overwritten by new data (1).

■ Changing the time from current to future

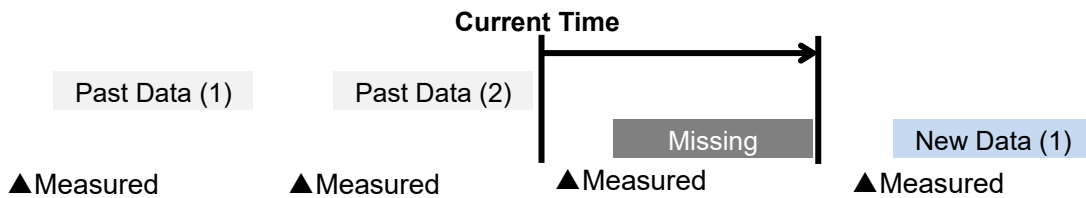

If the time is changed from current to future while past data (1) and (2) are stored, collected data between the past data (2) and the new data (1) is lost.

12.6. Web UI Screen on Internet Explorer 8 (IE8)

If the Web UI screen is viewed on Internet Explorer 8, it may be displayed as shown below.

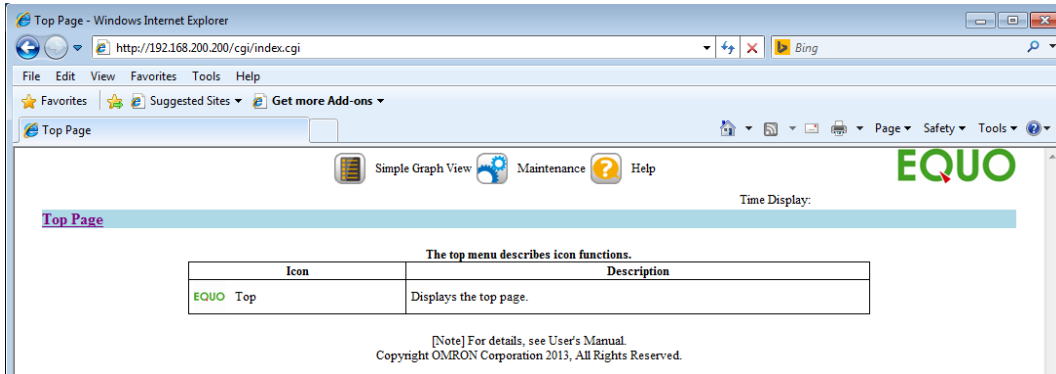

This is caused by compatibility view mode of Internet Explorer 8 setting.

■ Solution

- 1) Press F12 key, select [System] - [Development Tools].
- 2) Set the "browser mode" to "Internet Explorer 8 Compatibility View".

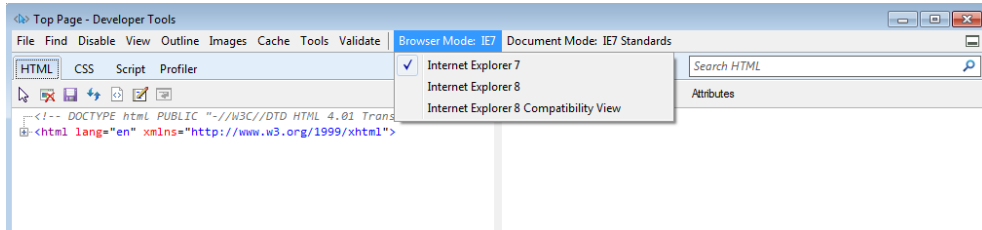

- 3) Set the "document mode" to "Internet Explorer 8 Standards".

Reference

- Shown below are relations between browser/document modes of Internet Explorer 8 and Web UI screen view:

Web UI screen Yes: Normal view, No: Abnormal view, N/A: Unselectable

Browser Mode	Document Mode		
	Quirks Mode	Internet Explorer 7 Standards	Internet Explorer 8 Standards
Internet Explorer 7	No	No	N/A
Internet Explorer 8	No	No	Yes
Internet Explorer 8 Compatibility View	No	No	Yes

12.7. Communications Protocol

Shown below are communications protocols used for EQ100:

Protocol Name	Interface	Port Number	Upper Level Communications	Lower Level Communications
CompoWay/F	RS-485	N/A	N/A	Yes
Modbus RTU	RS-485	N/A	N/A	Yes
EPC Communication Protocol	LAN	2323	N/A	Yes
WZ Communication Protocol	LAN	16000	N/A	Yes
FINS	LAN	9600	N/A	Yes
EQUO-LINK	LAN	4211	Yes	N/A
HTTP	LAN	80	Yes	N/A
SNTP	LAN	123	Yes	N/A
SMTP	LAN	25	Yes	N/A
FTP	LAN	21	Yes	N/A
POP3	LAN	110	Yes	N/A

12.8. SD Card Folder Configuration

Shown below is SD card folder configuration used for EQ100:

Folder	Details	Description
¥EQ_[serial number]	Folder for each EQ100	This folder is created for each EQ100. To share an SD card among multiple EQ100s, a serial number is included.
¥measurement¥	CSV file save	This folder stores internal system file for EQ100 operation or SD card output.
¥event_log¥	Event log file save	This folder stores event log files by EQ100 operation.
¥project¥	Project file export destination	This folder stores project files by EQ100 operation.
¥.binlog	Measured data SD backup folder	This folder is created if the SD card output is configured. Data over one week is referred by using the data in this folder. The file format is binary which a user cannot directly view.
¥EQ_Project	For project file write	This folder stores project files to be read by EQ100 operation.

12.9. Output File Format

12.9.1. Internal System File (e.g. SD Card Output, FTP Download)

File name: "SNC_ID"_YYYYMMDDhhmmss_"XXX".csv

Note: SNC_ID: Unit identifier for EQ100

YYYYMMDDhhmmss: Time slot of measured data file (for EQ100, mmss is 0000 fixed)

XXX: Count of measurement start and collecting for EQ100. Increased by one every time a status transitions to the collecting status. When exceeded 999, the count becomes 000.

Output example: 9ff034_20130513150000_009.csv

File format: CSV, UTF-8 (No BOM) code, LF linefeed

Component: Header block + Data block

Header Block
<pre>#OMRON,EQUO,file format version<LF> #SNC ID, model ID, sensor ID, model, <version>, <operation mode>, <measurement mode>, channels<LF> #CH0, measurement type, UPPER, <upper limit>, LOWER,<lower limit>, SCALE, <scaling value>, SUMMARY_TYPE,<summary type><LF> #CH1, measurement type, UPPER, <upper limit>, LOWER,<lower limit>, SCALE, <scaling value>, SUMMARY_TYPE,<summary type><LF> #CH2, measurement type, UPPER, <upper limit>, LOWER,<lower limit>, SCALE, <scaling value>, SUMMARY_TYPE,<summary type><LF> ... #SAMPLING, <sampling interval><LF> #SUMMARY,TRUE<LF> #CH:TYPE_ID,<CH0 model ID>,<CH1 model ID>,...<LF> #CH:MODEL_NAME,<CH0 model>,<CH1 model>,...<LF> #CH:SERIAL, <CH0 device serial number>,< CH1 device serial number>, ... <LF> #CH:ANNOTATION, <CH0 channel name>,<CH1 channel name>,...<LF> #CH:ID, <CH0 ID>, <CH1 ID>, ...<LF> #DATE, TIME, ALM, CH0, CH1...<LF></pre>
Data Block
<pre><date>,<time>,L,<CH0 measured value>,<CH1 measured value>,...<LF> <date>,<time>,L,<CH0 measured value>,<CH1 measured value>,...<LF> <date>,<time>,L,<CH0 measured value>,<CH1 measured value>,...<LF> <LF></pre>

■ Header Block

- Each line of the header block starts with a character "#". The number of lines depends on the configuration. This section describes information of data for secondary use.

For other output specifications, contact OMRON.

Item	Details
1st line	This line is always outputted. #OMRON,EQUO,1.5 fixed
2nd line	This line is always outputted. SNC_ID is a unique ID for each EQ100. Channels indicate the number of channels to output Others are fixed character strings
#CHx (x is a number)	Indicates channel information. For EQ100, other information than data type is not used. An internal name corresponding to a data type indicated as Manager is collected.
#CH:ANNOTATION	A channel name is collected. Names for the number of the channels are collected.
#DATE,...	After this line, the data block starts.

■ Data Block

Item	Details
<date>	Date of a graph being viewed. Format: YYYY/MM/DD
<time>	Time in a format hh:mm:00.000.
L	"L" is collected (fixed).
<measured value [n]>	A value corresponding to the header of the graph being viewed.

[n]: repeat count of the number of channel

A timestamp of each data outputted in a CSV file (collected data file) is based on a device with the shortest cycle among the measurement channels.

A measured value is collected for a channel that successfully collected data. A blank is collected for a measured value of the time not included in the measurement target.

For a measured value not collected due to communications error, a character string "ERROR" is outputted.

Communication Result	Output Value	Remarks
Normal	A value collected from a measurement device	e.g.) 99.99
Abnormal	"ERROR"	If an operation target of an operation channel is "ERROR", the operation channel is "ERROR" as well
No Communications	Blank	-

e.g.: In case of channel 0 (CH0) = 1 minute cycle, channel 1 (CH1) = 5 minute cycle

(communications error occurred at 00:03:00 in CH0)

2013/06/12,13:00:00.000,L,100,200<LF>

2013/06/12,13:01:00.000,L,100,<LF>

2013/06/12,13:02:00.000,L,100,<LF>

2013/06/12,13:03:00.000,L,ERROR,<LF>

2013/06/12,13:04:00.000,L,100,<LF>

2013/06/12,13:05:00.000,L,100,300<LF>

2013/06/12,13:06:00.000,L,100,<LF>

2013/06/12,13:07:00.000,L,100,<LF>

2013/06/12,13:08:00.000,L,100,<LF>

2013/06/12,13:09:00.000,L,100,<LF>

2013/06/12,13:10:00.000,L,100,400<LF>

12.9.2. Use-specified file (data acquisition with Web UI, user-specified file)

File name: "SNC_ID"_YYYYMMDDhhmmss_YYYYMMDDhhmmss_ "X".csv

SNC_ID: Unit identifier for EQ100

" X" : Number of file output times for file output at the specified time from EQ100. Starts from 1, and increments when the output time is duplicated such as when the start time returns.

Omitted for the data acquisition by Web UI.

YYYYMMDDhhmmss: Start and end time of measured data output period

Data acquisition output example by Web UI : 9ff034_20130513150000_20130513150959.csv

User specified file output example : 9ff034_20130513150000_20130513150959_1.csv

File format: CSV, UTF-8 (BOM)/UTF-8n (No BOM) code, LF linefeed

Component: Header block + Data block

Header Block
Date/time column,<channel information 1>,<channel information 2>,... ...<LF>
Data Block
<date/time line>,<value 1>,<value 2>,...<LF> ...<LF>

You can select from the following date/time columns:

(1) Output in three columns

DATE,TIME,MESC,...

2011/06/06,00:00:00,000,...

(2) Output in two columns

DATE,TIME,...

2011/06/06,00:00:00,...

(3) Output in one column

DATETIME,...

2011/06/06 00:00:00,...

Shown below is a specific example:

e.g.:

The date/time is in 3-column format.

Channel 1: Channel name=Electric energy 1,Unit=kWh,Data type name=Electric energy,1-minute cycle

Channel 2: Channel name=Electric energy 2,Unit=kWh,Data type name=Electric energy,10-minute cycle

Channel 3: Channel name=Temperature 1,Unit=°C,Data type name=Temperature,10-minute cycle

DATE,TIME,MSEC,Electric energy 1(kWh)(Electric energy),Electric energy

2(kWh)(Electric energy), Temperature (°C)(temperature)

2011/06/06,00:00:00,000,22.43,11.96,18.4<LF>

2011/06/06,00:00:01,000,20.21,,<LF>

2011/06/06,00:00:02,000,22.12,,<LF>

2011/06/06,00:00:03,000,20.03,,<LF>

2011/06/06,00:00:04,000,22.43,,<LF>

2011/06/06,00:00:05,000,20.03,,<LF>

2011/06/06,00:00:06,000,21.48,,<LF>

2011/06/06,00:00:07,000,21.48,,<LF>

2011/06/06,00:00:08,000,20.03,,<LF>

2011/06/06,00:00:09,000,22.12,,<LF>

2011/06/06,00:00:10,000,20.21,12.01,18.2<LF>

2011/06/06,00:00:11,000,20.03,,<LF>

Described below are item details:

■ Header Block

Item	Details
<date/time column>	Either of the followings is outputted. (1) Output in three columns DATE,TIME,MESC (2) Output in two columns DATE,TIME (3) Output in one column DATETIME
<channel information{n}>	Channel information consists of the following parameters: <channel name> A channel name configured in an EQ server project. <(unit)> The unit of the nth data being displayed on the graph. A unit for data type configured for each channel (a data type unit is configured in an EQ server project). * "-"(hyphen) is outputted if no unit applies. <(data type name{n})> The data type name of the nth data being displayed on the graph. A data type name is configured in an EQ server project.

■ Data Block

Item	Details
<date/time column> Year/month/date	- Year/month/date Date of a graph being viewed. Format: YYYY/MM/DD - Time Information of hour, minute, and second of the graph being viewed. Format: "hh:mm:ss". Note that 00 is outputted if a time value is smaller than the view duration. For example, if a graph is displayed for days (summarized on a 30 minute basis), only "00" and "30" are outputted for minute unit and "00" fixed for second unit. - Millisecond Information of millisecond of the graph being viewed. 000 fixed. The value is "000" fixed. If a date output is specified as one-column output, a space is inserted between the date and the time.
<value{n}>	A value corresponding to the header of the graph being viewed.

[n]: repeat count of the number of channel

■ Others

A timestamp of each data outputted in a CSV file (collected data file) is based on a device with the shortest cycle among the measurement channels.

A measured value is outputted for a channel successfully collected data. A blank is collected for a measured value of the time not included in the measurement target and a measured value not collected due to communications error.

Communication Result	Output Value	Remarks
Normal	A value collected from a measurement device	e.g.) 99.99
Error	Blank	= If the operation target of an operation channel is a blank, the operation channel becomes a blank as well
No Communications	Blank	-

12.9.3. Event Log File

EQ100 saves error detection, monitoring function, and operation status changes with the occurred hour as event log files for its device management function.

The event log files can be externally outputted by using EQ-Manager or Web UI operation. They can be viewed on the Web screen.

Up to 640 logs are collected. When exceeded, older logs are deleted, from the oldest one.

<Event Log File Format>

- File name: "event_log_" + [SNC ID] + "_" + [YYYYMMDDHHMMSS] ".csv"

- File format: CSV, UTF-8 (No BOM) code, LF linefeed

(If the language is configured as Japanese, shift-jis and CRLF linefeed)

- Component:

900001

->SNC ID

DATE,TIME, CODE,DATA

-> Label: "DATE","TIME","CODE","DATA"

2010/05/01,01:13:27,30,005006,Abnormal battery voltage occurred, Open the top cover and replace the battery within 5 minutes.

2010/05/01,00:02:40,92,000005,New setup registration/update,

:

DATE : Occurred date, 10 characters

TIME : Occurred time, 8 characters

CODE : Log code

DATA : Internal code, event name, action (if any)

12.10. Software License

This product uses the following open source software.

Although the software is not guaranteed based on the copyright by nature of open source, this product is guaranteed by the warranty certificate and conditions described in "Introduction" section of this manual.

- Linux
- BusyBox
- RedBoot
- lighttpd
- PHP
- msmtpt
- ntpd
- cheetan
- prototype.js
- getElementsByClassName
- Ruby
- ProFTPD

GPL License

Linux, BusyBox, and RedBoot are target of GPL version 2.0.

For GPL license, refer to the following URL:
<http://www.gnu.org/licenses/gpl-2.0.html>

For modified GPL target modules and distribution of them, contact our sales representative. Note that costs incurred at the time of distribution shall be borne by the customer.

lighttpd

Copyright (c) 2004, Jan Kneschke, incremental
 All rights reserved.

Redistribution and use in source and binary forms, with or without modification, are permitted provided that the following conditions are met:

- Redistributions of source code must retain the above copyright notice, this list of conditions and the following disclaimer.
- Redistributions in binary form must reproduce the above copyright notice, this list of conditions and the following disclaimer in the documentation and/or other materials provided with the distribution.
- Neither the name of the 'incremental' nor the names of its contributors may be used to endorse or promote products derived from this software without specific prior written permission.

THIS SOFTWARE IS PROVIDED BY THE COPYRIGHT HOLDERS AND CONTRIBUTORS "AS IS" AND ANY EXPRESS OR IMPLIED WARRANTIES, INCLUDING, BUT NOT LIMITED TO, THE IMPLIED WARRANTIES OF MERCHANTABILITY AND FITNESS FOR A PARTICULAR PURPOSE ARE DISCLAIMED. IN NO EVENT SHALL THE COPYRIGHT OWNER OR CONTRIBUTORS BE LIABLE FOR ANY DIRECT, INDIRECT, INCIDENTAL, SPECIAL, EXEMPLARY, OR CONSEQUENTIAL DAMAGES (INCLUDING, BUT NOT LIMITED TO, PROCUREMENT OF SUBSTITUTE GOODS OR SERVICES; LOSS OF USE, DATA, OR PROFITS; OR BUSINESS INTERRUPTION) HOWEVER CAUSED AND ON ANY THEORY OF LIABILITY, WHETHER IN CONTRACT, STRICT LIABILITY, OR TORT (INCLUDING NEGLIGENCE OR OTHERWISE) ARISING IN ANY WAY OUT OF THE USE OF THIS SOFTWARE, EVEN IF ADVISED OF THE POSSIBILITY OF SUCH DAMAGE.

PHP License

The PHP License, Version 3.0
Copyright (c) 1999 - 2003 The PHP Group. All rights reserved.

Redistribution and use in source and binary forms, with or without modification, is permitted provided that the following conditions are met:

1. Redistributions of source code must retain the above copyright notice, this list of conditions and the following disclaimer.
2. Redistributions in binary form must reproduce the above copyright notice, this list of conditions and the following disclaimer in the documentation and/or other materials provided with the distribution.
3. The name "PHP" must not be used to endorse or promote products derived from this software without prior written permission. For written permission, please contact group@php.net.
4. Products derived from this software may not be called "PHP", nor may "PHP" appear in their name, without prior written permission from group@php.net. You may indicate that your software works in conjunction with PHP by saying "Foo for PHP" instead of calling it "PHP Foo" or "phpfoo".
5. The PHP Group may publish revised and/or new versions of the license from time to time. Each version will be given a distinguishing version number.
Once covered code has been published under a particular version of the license, you may always continue to use it under the terms of that version. You may also choose to use such covered code under the terms of any subsequent version of the license published by the PHP Group. No one other than the PHP Group has the right to modify the terms applicable to covered code created under this License.
6. Redistributions of any form whatsoever must retain the following acknowledgment:
"This product includes PHP, freely available from
<<http://www.php.net/>>".

THIS SOFTWARE IS PROVIDED BY THE PHP DEVELOPMENT TEAM ``AS IS" AND ANY EXPRESSED OR IMPLIED WARRANTIES, INCLUDING, BUT NOT LIMITED TO, THE IMPLIED WARRANTIES OF MERCHANTABILITY AND FITNESS FOR A

PARTICULAR PURPOSE ARE DISCLAIMED. IN NO EVENT SHALL THE PHP DEVELOPMENT TEAM OR ITS CONTRIBUTORS BE LIABLE FOR ANY DIRECT, INDIRECT, INCIDENTAL, SPECIAL, EXEMPLARY, OR CONSEQUENTIAL DAMAGES (INCLUDING, BUT NOT LIMITED TO, PROCUREMENT OF SUBSTITUTE GOODS OR SERVICES; LOSS OF USE, DATA, OR PROFITS; OR BUSINESS INTERRUPTION) HOWEVER CAUSED AND ON ANY THEORY OF LIABILITY, WHETHER IN CONTRACT, STRICT LIABILITY, OR TORT (INCLUDING NEGLIGENCE OR OTHERWISE) ARISING IN ANY WAY OUT OF THE USE OF THIS SOFTWARE, EVEN IF ADVISED OF THE POSSIBILITY OF SUCH DAMAGE.

This software consists of voluntary contributions made by many individuals on behalf of the PHP Group.

The PHP Group can be contacted via Email at group@php.net.

For more information on the PHP Group and the PHP project, please see [<http://www.php.net>](http://www.php.net).

This product includes the Zend Engine, freely available at [<http://www.zend.com>](http://www.zend.com).

ntpd

Copyright (c) David L. Mills 1992-2006

Permission to use, copy, modify, and distribute this software and its documentation for any purpose with or without fee is hereby granted, provided that the above copyright notice appears in all copies and that both the copyright notice and this permission notice appear in supporting documentation, and that the name University of Delaware not be used in advertising or publicity pertaining to distribution of the software without specific, written prior permission. The University of Delaware makes no representations about the suitability this software for any purpose. It is provided "as is" without express or implied warranty.

cheetan

cheetan is licensed under the MIT license.
copyright (c) 2006 cheetan all right reserved.
<http://php.cheetan.net/>

prototype.js

Copyright (c) 2005-2010 Sam Stephenson

Permission is hereby granted, free of charge, to any person obtaining a copy of this software and associated documentation files (the "Software"), to deal in the Software without restriction, including without limitation the rights to use, copy, modify, merge, publish, distribute, sublicense, and/or sell copies of the Software, and to permit persons to whom the Software is furnished to do so, subject to the following conditions:

THE SOFTWARE IS PROVIDED "AS IS", WITHOUT WARRANTY OF ANY KIND, EXPRESS OR IMPLIED, INCLUDING BUT NOT LIMITED TO THE WARRANTIES OF MERCHANTABILITY, FITNESS FOR A PARTICULAR PURPOSE AND NONINFRINGEMENT. IN NO EVENT SHALL THE AUTHORS OR COPYRIGHT HOLDERS BE LIABLE FOR ANY CLAIM, DAMAGES OR OTHER LIABILITY, WHETHER IN AN ACTION OF CONTRACT, TORT OR OTHERWISE, ARISING FROM, OUT OF OR IN CONNECTION WITH THE SOFTWARE OR THE USE OR OTHER DEALINGS IN THE SOFTWARE.

getElementsByClassName

Copyright 2007 futomi <http://www.html5.jp/>

Licensed under the Apache License, Version 2.0 (the "License");
you may not use this file except in compliance with the License.
You may obtain a copy of the License at

<http://www.apache.org/licenses/LICENSE-2.0>

Unless required by applicable law or agreed to in writing, software distributed under the License is distributed on an "AS IS" BASIS, WITHOUT WARRANTIES OR CONDITIONS OF ANY KIND, either express or implied. See the License for the specific language governing permissions and limitations under the License.

Ruby

Ruby is copyrighted free software by KITAITI Makoto <KitaitiMakoto@gmail.com>. You can redistribute it and/or modify it under either the terms of GPL (the GNU General Public License), or the conditions below: For GPL, refer to the GPL file.

1. You may make and give away verbatim copies of the source form of the software without restriction, provided that you duplicate all of the original copyright notices and associated disclaimers.
2. You may modify your copy of the software in any way, provided that you do at least ONE of the following:
 - (a) place your modifications in the Public Domain or otherwise make them Freely Available, such as by posting said modifications to Usenet or an equivalent medium, or by allowing the author to include your modifications in the software.
 - (b) use the modified software only within your corporation or organization.
 - (c) give non-standard binaries non-standard names, with instructions on where to get the original software distribution.
 - (d) make other distribution arrangements with the author.
3. You may distribute the software in object code or binary form, provided that you do at least ONE of the following:
 - (a) distribute the binaries and library files of the software, together with instructions (in the manual page or equivalent) on where to get the original distribution.
 - (b) accompany the distribution with the machine-readable source of the software.
 - (c) give non-standard binaries non-standard names, with instructions on where to get the original software distribution.
 - (d) make other distribution arrangements with the author.
4. You may modify and include the part of the software into any other software (possibly commercial). But some files in the distribution are not written by the author, so that they are not under these terms.

For the list of those files and their copying conditions, see the file LEGAL.

5. The scripts and library files supplied as input to or produced as output from the software do not automatically fall under the copyright of the software, but belong to whomever generated them, and may be sold commercially, and may be summarized with this software.
6. THIS SOFTWARE IS PROVIDED "AS IS" AND WITHOUT ANY EXPRESS OR IMPLIED WARRANTIES, INCLUDING, WITHOUT LIMITATION, THE IMPLIED WARRANTIES OF MERCHANTABILITY AND FITNESS FOR A PARTICULAR PURPOSE.

msmtp

msmtp is an SMTP client.

In the default mode, it transmits a mail to an SMTP server (for example at a free mail provider) which does the delivery.

To use this program with your mail user agent (MUA), create a configuration file with your mail account(s) and tell your MUA to call msmtp instead of /usr/sbin/sendmail.

Features include:

- Sendmail compatible interface (command line options and exit codes).
- PIPELINING support for increased transmission speed.
- DSN (Delivery Status Notification) support.
- RMQS (Remote Message Queue Starting) support (ETRN keyword).
- IPv6 support.
- LMTP support.
- Authentication methods PLAIN, LOGIN, and CRAM-MD5.
- Support for multiple accounts.

Optional features, depending on external libraries:

- TLS/SSL support, including client certificates (requires GnuTLS or OpenSSL).
- Additional authentication methods EXTERNAL, GSSAPI, SCRAM-SHA-1, DIGEST-MD5, NTLM (requires GNU Libgsasl).
- Support for Internationalized Domain Names (IDN) (requires GNU Libidn).
- Native language support (NLS) (may require GNU libintl).

The homepage of this program is <<http://msmtp.sourceforge.net/>>.

This program is free software; you can redistribute it and/or modify it under the terms of the GNU General Public License (see the file COPYING) as published by the Free Software Foundation; either version 3 of the License, or (at your option) any later version.

ProFTPD

```
/*
 * ProFTPD - FTP server daemon
 * Copyright (c) 1997, 1998 Public Flood Software
 * Copyright (c) 1999, 2000 MacGyver aka Habeeb J. Dihu <macgyver@tos.net>
 * Copyright (c) 2001-2011 The ProFTPD Project team
 *
 * This program is free software; you can redistribute it and/or modify
 * it under the terms of the GNU General Public License as published by
 * the Free Software Foundation; either version 2 of the License, or
 * (at your option) any later version.
 *
 * This program is distributed in the hope that it will be useful,
 * but WITHOUT ANY WARRANTY; without even the implied warranty of
 * MERCHANTABILITY or FITNESS FOR A PARTICULAR PURPOSE. See the
 * GNU General Public License for more details.
 *
 * You should have received a copy of the GNU General Public License
 * along with this program; if not, write to the Free Software
 * Foundation, Inc., 51 Franklin Street, Suite 500, Boston, MA 02110-1335, USA.
 *
 * As a special exemption, The ProFTPD Project and other respective copyright
 * holders give permission to link this program with OpenSSL, and distribute
 * the resulting executable, without including the source code for OpenSSL in
 * the source distribution.
 */
```

(MEMO)

OMRON Corporation Industrial Automation Company
Kyoto, JAPAN

Contact: www.ia.omron.com

Regional Headquarters

OMRON EUROPE B.V.

Wegalaan 67-69, 2132 JD Hoofddorp
The Netherlands
Tel: (31)2356-81-300/Fax: (31)2356-81-388

OMRON ELECTRONICS LLC

2895 Greenspoint Parkway, Suite 200
Hoffman Estates, IL 60169 U.S.A.
Tel: (1) 847-843-7900/Fax: (1) 847-843-7787

OMRON ASIA PACIFIC PTE. LTD.

No. 438A Alexandra Road # 05-05/08 (Lobby 2),
Alexandra Technopark,
Singapore 119967
Tel: (65) 6835-3011/Fax: (65) 6835-2711

OMRON (CHINA) CO., LTD.

Room 2211, Bank of China Tower,
200 Yin Cheng Zhong Road,
PuDong New Area, Shanghai, 200120, China
Tel: (86) 21-5037-2222/Fax: (86) 21-5037-2200

Authorized Distributor:

© OMRON Corporation 2017 All Rights Reserved.
In the interest of product improvement,
specifications are subject to change without notice.

Cat. No. N196-E1-03

1021