

Digital Temperature Controllers

User's Manual

E5□D

1
Introduction

2
Preparations

3
Part Names and
Basic Procedures

4
Basic
Operation

5
Advanced
Operations

6
Parameters

7
User Calibration

A
Appendices

I
Index



Preface

Thank you for purchasing an E5□D Digital Controller.

This manual describes how to use the E5□D. Read this manual thoroughly and be sure you understand it before attempting to use the Digital Controller and use the Digital Controller correctly according to the information provided. Keep this manual in a safe place for easy reference. Refer to the *E5□D Digital Controllers Communications Manual* (Cat. No. H225) for information on communications.

© OMRON, 2017-2022

All rights reserved. No part of this publication may be reproduced, stored in a retrieval system or transmitted, in any form, or by any means, mechanical, electronic, photocopying, recording, or otherwise, without the prior written permission of OMRON.

No patent liability is assumed with respect to the use of the information contained herein. Moreover, because OMRON is constantly striving to improve its high-quality products, the information contained in this manual is subject to change without notice. Every precaution has been taken in the preparation of this manual. Nevertheless, OMRON assumes no responsibility for errors or omissions. Neither is any liability assumed for damages resulting from the use of the information contained in this publication.

Terms and Conditions Agreement

Warranty, Limitations of Liability

Warranties

- **Exclusive Warranty**

Omron's exclusive warranty is that the Products will be free from defects in materials and workmanship for a period of twelve months from the date of sale by Omron (or such other period expressed in writing by Omron). Omron disclaims all other warranties, express or implied.

- **Limitations**

OMRON MAKES NO WARRANTY OR REPRESENTATION, EXPRESS OR IMPLIED, ABOUT NON-INFRINGEMENT, MERCHANTABILITY OR FITNESS FOR A PARTICULAR PURPOSE OF THE PRODUCTS. BUYER ACKNOWLEDGES THAT IT ALONE HAS DETERMINED THAT THE PRODUCTS WILL SUITABLY MEET THE REQUIREMENTS OF THEIR INTENDED USE.

Omron further disclaims all warranties and responsibility of any type for claims or expenses based on infringement by the Products or otherwise of any intellectual property right.

- **Buyer Remedy**

Omron's sole obligation hereunder shall be, at Omron's election, to (i) replace (in the form originally shipped with Buyer responsible for labor charges for removal or replacement thereof) the non-complying Product, (ii) repair the non-complying Product, or (iii) repay or credit Buyer an amount equal to the purchase price of the non-complying Product; provided that in no event shall Omron be responsible for warranty, repair, indemnity or any other claims or expenses regarding the Products unless Omron's analysis confirms that the Products were properly handled, stored, installed and maintained and not subject to contamination, abuse, misuse or inappropriate modification. Return of any Products by Buyer must be approved in writing by Omron before shipment. Omron Companies shall not be liable for the suitability or unsuitability or the results from the use of Products in combination with any electrical or electronic components, circuits, system assemblies or any other materials or substances or environments. Any advice, recommendations or information given orally or in writing, are not to be construed as an amendment or addition to the above warranty.

See <http://www.omron.com/global/> or contact your Omron representative for published information.

Limitation on Liability; Etc

OMRON COMPANIES SHALL NOT BE LIABLE FOR SPECIAL, INDIRECT, INCIDENTAL, OR CONSEQUENTIAL DAMAGES, LOSS OF PROFITS OR PRODUCTION OR COMMERCIAL LOSS IN ANY WAY CONNECTED WITH THE PRODUCTS, WHETHER SUCH CLAIM IS BASED IN CONTRACT, WARRANTY, NEGLIGENCE OR STRICT LIABILITY.

Further, in no event shall liability of Omron Companies exceed the individual price of the Product on which liability is asserted.

Application Considerations

Suitability of Use

Omron Companies shall not be responsible for conformity with any standards, codes or regulations which apply to the combination of the Product in the Buyer's application or use of the Product. At Buyer's request, Omron will provide applicable third party certification documents identifying ratings and limitations of use which apply to the Product. This information by itself is not sufficient for a complete determination of the suitability of the Product in combination with the end product, machine, system, or other application or use. Buyer shall be solely responsible for determining appropriateness of the particular Product with respect to Buyer's application, product or system. Buyer shall take application responsibility in all cases.

NEVER USE THE PRODUCT FOR AN APPLICATION INVOLVING SERIOUS RISK TO LIFE OR PROPERTY WITHOUT ENSURING THAT THE SYSTEM AS A WHOLE HAS BEEN DESIGNED TO ADDRESS THE RISKS, AND THAT THE OMRON PRODUCT(S) IS PROPERLY RATED AND INSTALLED FOR THE INTENDED USE WITHIN THE OVERALL EQUIPMENT OR SYSTEM.

Programmable Products

Omron Companies shall not be responsible for the user's programming of a programmable Product, or any consequence thereof.

Disclaimers

Performance Data

Data presented in Omron Company websites, catalogs and other materials is provided as a guide for the user in determining suitability and does not constitute a warranty. It may represent the result of Omron's test conditions, and the user must correlate it to actual application requirements. Actual performance is subject to the Omron's Warranty and Limitations of Liability.

Change in Specifications

Product specifications and accessories may be changed at any time based on improvements and other reasons. It is our practice to change part numbers when published ratings or features are changed, or when significant construction changes are made. However, some specifications of the Product may be changed without any notice. When in doubt, special part numbers may be assigned to fix or establish key specifications for your application. Please consult with your Omron's representative at any time to confirm actual specifications of purchased Product.

Errors and Omissions

Information presented by Omron Companies has been checked and is believed to be accurate; however, no responsibility is assumed for clerical, typographical or proofreading errors or omissions.

Safety Precautions

Definition of Precautionary Information





The following notation is used in this manual to provide precautions required to ensure safe usage of the E5□D Digital Controllers.

The safety precautions that are provided are extremely important to safety. Always read and heed the information provided in all safety precautions.

The following notation is used.

 CAUTION	Indicates a potentially hazardous situation which, if not avoided, may result in minor or moderate injury or in property damage.
--	--

Symbols

Symbol	Meaning	
Caution		<ul style="list-style-type: none"> ● General Caution Indicates non-specific general cautions, warnings, and dangers.
		<ul style="list-style-type: none"> ● Electrical Shock Caution Indicates possibility of electric shock under specific conditions.
Prohibition		<ul style="list-style-type: none"> ● General Prohibition Indicates non-specific general prohibitions.
		<ul style="list-style-type: none"> ● Disassembly Prohibition Indicates prohibitions when there is a possibility of injury, such as from electric shock, as the result of disassembly.
Mandatory Caution		<ul style="list-style-type: none"> ● General Caution Indicates non-specific general cautions, warnings, and dangers.

● Safety Precautions

 **CAUTION**

Minor injury due to electric shock may occasionally occur.
Do not touch the terminals while power is being supplied.



Electric shock, fire, or malfunction may occasionally occur.
Do not allow metal objects, conductors, debris (such as cuttings) from installation work, moisture, or other foreign matter to enter the Digital Controller, the Setup Tool ports, or between the pins on the connectors on the Setup Tool cable.
Attach the cover to the front-panel Setup Tool port whenever you are not using it to prevent foreign objects from entering the port.



Minor injury from explosion may occasionally occur.
Do not use the product where subject to flammable or explosive gas.



Minor electric shock or fire may occasionally occur.
Do not use a Digital Controller or cable that is damaged.



Minor electric shock, fire, or malfunction may occasionally occur.
Never disassemble, modify, or repair the product or touch any of the internal parts.



If the output relays are used past their life expectancy, contact fusing or burning may occasionally occur.
Always consider the application conditions and use the output relays within their rated load and electrical life expectancy. The life expectancy of output relays varies considerably with the output load and switching conditions.



 **CAUTION**

Loose screws may occasionally result in fire. Tighten the terminal screws to the specified torque of 0.43 to 0.58 N·m.



Set the parameters of the product so that they are suitable for the system being controlled. If they are not suitable, unexpected operation may occasionally result in property damage or accidents.



A malfunction in the Digital Controller may occasionally make control operations impossible or prevent alarm outputs, resulting in property damage. To maintain safety in the event of malfunction of the Digital Controller, take appropriate safety measures, such as installing a monitoring device on a separate line.



Take adequate security measures against DDoS attacks (Distributed Denial of Service attacks), computer viruses and other technologically harmful programs, unauthorized access and other possible attacks before using this product.

Security Measures

Anti-virus protection

Install the latest commercial-quality antivirus software on the computer connected to the control/monitor system and maintain to keep the software up-to-date.



Security measures to prevent unauthorized access

Take the following measures to prevent unauthorized access to our products.

- Install physical controls so that only authorized personnel can access control/monitor systems and equipment.
- Reduce connections to control/monitor systems and equipment via networks to prevent access from untrusted devices.
- Install firewalls to shut down unused communications ports and limit communications hosts and isolate control/monitor systems and equipment from the IT network.
- Use a virtual private network (VPN) for remote access to control/monitor systems and equipment.
- Scan virus to ensure safety of SD cards or other external storages before connecting them to control/monitor systems and equipment.



Data input and output protection

Validate backups and ranges to cope with unintentional modification of input/output data to control/monitor systems and equipment.

- Checking the scope of data
- Checking validity of backups and preparing data for restore in case of falsification and abnormalities
- Safety design, such as emergency shutdown, in case of data tampering and abnormalities



Data recovery

Backup data and keep the data up-to-date periodically to prepare for data loss.



Safety Standards

CAUTION - Risk of Fire and Electric Shock

- (a) This product is UL listed as Open Type Process Control Equipment. It must be mounted in an enclosure that does not allow fire to escape externally.
- (b) More than one disconnect switch may be required to de-energize the equipment before servicing.
- (c) Signal inputs are SELV, limited energy. ^{*1}
- (d) Caution: To reduce the risk of fire or electric shock, do not interconnect the outputs of different Class 2 circuits. ^{*2}



^{*1} An SELV (separated extra-low voltage) system is one with a power supply that has double or reinforced insulation between the primary and the secondary circuits and has an output voltage of 30 V r.m.s. max. and 42.4 V peak max. or 60 VDC max.

^{*2} A class 2 circuit is one tested and certified by UL as having the current and voltage of the secondary output restricted to specific levels.

Precautions for Safe Use

Be sure to observe the following precautions to prevent operation failure, malfunction, or adverse affects on the performance and functions of the product. Not doing so may occasionally result in unexpected events. Do not handle the Digital Controller in ways that exceed the ratings.

- (1) The product is designed for indoor use only. Do not use or store the product outdoors or in any of the following places.
 - Places directly subject to heat radiated from heating equipment.
 - Places subject to splashing liquid or oil atmosphere.
 - Places subject to direct sunlight.
 - Places subject to dust or corrosive gas (in particular, sulfide gas and ammonia gas).
 - Places subject to intense temperature change.
 - Places subject to icing and condensation.
 - Places subject to vibration and large shocks.
- (2) Use and store the Digital Controller within the rated ambient temperature and humidity. Gang-mounting two or more Digital Controllers, or mounting Digital Controllers above each other may cause heat to build up inside the Digital Controllers, which will shorten their service life. In such a case, use forced cooling by fans or other means of air ventilation to cool down the Digital Controllers.
- (3) To allow heat to escape, do not block the area around the Digital Controller. Do not block the ventilation holes on the Digital Controller.
- (4) Always check the terminal names and polarity and be sure to wire properly.
- (5) To connect bare wires, use copper stranded or solid wires. Use the wire sizes and stripping lengths given in the following table to prevent smoking and firing of the wiring material.

Recommended Wires

Model	Recommended wires	Stripping length
E5CD or E5ED	AWG24 to AWG18 (0.205 to 0.823 mm ²)	6 to 8 mm
E5□D-B (Push-In Plus terminal blocks)	0.25 to 1.5 mm ² (equivalent to AWG24 to AWG16)	Without ferrules: 8 mm

Use the specified size of crimped terminals to wire the E5CD or E5ED.

Crimp Terminal Sizes

Model	Crimp terminal size
E5CD or E5ED	M3, Width: 5.8 mm max.

For the E5□D-B (models with Push-In Plus terminal blocks), connect only one wire to each terminal. For the E5CD or E5ED (models with screw terminals), you can connect up to two wires of the same size and type, or two crimped terminals, to a single terminal.

- (6) Do not wire the terminals that are not used.

- (7) To avoid inductive noise, keep the wiring for the Digital Controller's terminal block away from power cables that carry high voltages or large currents. Also, do not wire power lines together with or parallel to Digital Controller wiring. Using shielded cables and using separate conduits or ducts is recommended.
- Attach a surge suppressor or noise filter to peripheral devices that generate noise (in particular, motors, transformers, solenoids, magnetic coils or other equipment that have an inductance component).
- When a noise filter is used at the power supply, first check the voltage or current, and attach the noise filter as close as possible to the Digital Controller.
- Allow as much space as possible between the Digital Controller and devices that generate powerful high frequencies (high-frequency welders, high-frequency sewing machines, etc.) or surge.
- (8) Use the Digital Controller within the rated load and power supply.
- (9) Make sure that the rated voltage is attained within 2 seconds of turning ON the power using a switch or relay contact. If the voltage is applied gradually, the power may not be reset or output malfunctions may occur.
- (10) Make sure that the Digital Controller has 30 minutes or more to warm up after turning ON the power before starting actual control operations to ensure the correct temperature display.
- (11) When using adaptive control, turn ON power for the load (e.g., heater) at the same time as or before supplying power to the Digital Controller. If power is turned ON for the Digital Controller before turning ON power for the load, tuning will not be performed properly and optimum control will not be achieved.
- (12) During tuning,* ensure that the power for the load (e.g., heater) is ON. If the power supply to the load (e.g., heater) is not turned ON during tuning, tuning results will not be calculated correctly and it will not be possible to achieve optimum control.
- * "Tuning" refers to the following functions: AT, adaptive control, automatic filter adjustment, and water-cooling output adjustment.
- (13) A switch or circuit breaker must be provided close to Digital Controller. The switch or circuit breaker must be within easy reach of the operator, and must be marked as a disconnecting means for Digital Controller.
- (14) Wipe off any dirt from the Digital Controller with a soft dry cloth. Never use thinners, benzene, alcohol, or any cleaners that contain these or other organic solvents. Deformation or discoloration may occur.
- (15) Design the system (e.g., control panel) considering the 2 seconds of delay in setting the Digital Controller's output after the power supply is turned ON.
- (16) The output will turn OFF when you move to the Initial Setting Level. Take this into consideration when performing control.
- (17) The number of non-volatile memory write operations is limited. Therefore, use RAM write mode when frequently overwriting data, e.g., through communications.
- (18) Always touch a grounded piece of metal before touching the Digital Controller to discharge static electricity from your body.
- (19) Use suitable tools when taking the Digital Controller apart for disposal. Sharp parts inside the Digital Controller may cause injury.
- (20) Install the DIN Track vertically to the ground.

- (21) Observe the following precautions when drawing out the body of the Digital Controller.
 - Follow the procedure given in *2-1-4 Drawing Out the Interior Body of the Digital Controller to Replace It* on page 2-7 of this manual.
 - Turn OFF the power supply before you start and never touch nor apply shock to the terminals or electric components.

When connecting or disconnecting the Main Unit, do not allow the electronic components to touch the rear case.
 - When you insert the interior body into the rear case, confirm that the hooks on the top and bottom are securely engaged with the case.
 - If the terminals are corroded, replace the rear case as well
- (22) For the power supply voltage input, use a commercial power supply with an AC input. Do not use the output from an inverter as the power supply. Depending on the output characteristics of the inverter, temperature increases in the product may cause smoke or fire damage even if the product has a specified output frequency of 50/60 Hz.
- (23) Do not continue to use the Digital Controller if the front surface peels.
- (24) Do not exceed the communications distance that is given in the specifications and use the specified communications cable.
- (25) Do not turn the power supply to the Digital Controller ON or OFF while the USB-Serial Conversion Cable is connected. The Digital Controller may malfunction.
- (26) Do not place heavy objects on top of the USB-Serial Conversion Cable, bend the Cable beyond its natural bending limit, or pull on the Cable. Doing so may result in failure.
- (27) Make sure that the indicators on the USB-Serial Conversion Cable are operating properly. Depending on the application conditions, deterioration in the connectors and cable may be accelerated, and normal communications may become impossible. Perform periodic inspection and replacement.
- (28) Do not disconnect the USB-Serial Conversion Cable while communications are in progress. The Digital Controller may be damaged or may malfunction.
- (29) Connectors may be damaged if they are inserted with excessive force. When connecting a connector, always make sure that it is oriented correctly. Do not force the connector if it does not connect smoothly.
- (30) Do not touch the external power supply terminals or other metal parts of the cables on the Digital Controller.
- (31) Noise may enter on the USB-Serial Conversion Cable, possibly causing equipment malfunctions. Do not leave the USB-Serial Conversion Cable connected constantly to the equipment.
- (32) With the E5ED/E5ED-B, do not connect cables to both the front-panel Setup Tool port and the top-panel Setup Tool port at the same time. The Digital Controller may be damaged or may malfunction.
- (33) Observe the following precautions when wiring the E5□D-B.
 - Follow the procedures given in E5□D-B (Models with Push-In Plus Terminal Blocks) on page 2-25 of this manual.
 - Do not wire anything to the release holes.
 - Do not tilt or twist a flat-blade screwdriver while it is inserted into a release hole on the terminal block. The terminal block may be damaged.
 - Insert a flat-blade screwdriver into the release holes at an angle. The terminal block may be damaged if you insert the screwdriver straight in.
 - Do not allow the flat-blade screwdriver to fall out while it is inserted into a release hole.
 - Do not bend a wire past its natural bending radius or pull on it with excessive force. Doing so may cause the wire to break.
 - Do not use crossover wiring except for the input power supply and communications.

Precautions for Correct Use

● Service Life

- (1) Use the Digital Controller within the following temperature and humidity ranges:
Temperature: –10 to 55°C (with no icing or condensation), Humidity: 25% to 85%
If the Digital Controller is installed inside a control board, the ambient temperature must be kept to under 55°C, including the temperature around the Digital Controller.
- (2) The service life of electronic devices like Digital Controllers is determined not only by the number of times the relay is switched but also by the service life of internal electronic components. Component service life is affected by the ambient temperature: the higher the temperature, the shorter the service life and, the lower the temperature, the longer the service life. Therefore, the service life can be extended by lowering the temperature of the Digital Controller.
- (3) When two or more Digital Controllers are mounted horizontally close to each other or vertically next to one another, the internal temperature will increase due to heat radiated by the Digital Controllers and the service life will decrease. In such a case, use forced cooling by fans or other means of air ventilation to cool down the Digital Controllers. When providing forced cooling, however, be careful not to cool down the terminals sections alone to avoid measurement errors.

● Ensuring Measurement Accuracy

- (1) When extending or connecting the thermocouple lead wire, be sure to use compensating wires that match the thermocouple types.
- (2) When extending or connecting the lead wire of the platinum resistance thermometer, be sure to use wires that have low resistance and keep the resistance of the three lead wires the same.
- (3) Mount the Digital Controller so that it is horizontally level.
- (4) If the measurement accuracy is low, check to see if input shift has been set correctly.

● Resistance to Water

The degree of protection is as shown below. Sections without any specification on their degree of protection or those with IP□0 are not waterproof.

Front panel: IP66

Rear case: IP20, Terminal section: IP00

When waterproofing is required, insert the Waterproof Packing on the backside of the front panel. Keep the Port Cover on the front-panel Setup Tool port of the E5ED or E5ED-B securely closed. The degree of protection when the Waterproof Packing is used is IP66. To maintain an IP66 degree of protection, the Waterproof Packing and the Port Cover for the front-panel Setup Tool port must be periodically replaced because they may deteriorate, shrink, or harden depending on the operating environment. The replacement period will vary with the operating environment. Check the required period in the actual application. Use 3 years or sooner as a guideline. If the Waterproof Packing and Port Cover are not periodically replaced, waterproof performance may not be maintained.

If a waterproof structure is not required, then the Waterproof Packing does not need to be installed.

● Precautions during Operation

- (1) It takes approximately two seconds for the outputs to turn ON from after the power supply is turned ON. Design the system (e.g., control panel) to allow for this delay.
- (2) Make sure that the Digital Controller has 30 minutes or more to warm up after turning ON the power before starting actual control operations to ensure the correct temperature display.
- (3) Avoid using the Digital Controller in places near a radio, television set, or wireless installing. The Digital Controller may cause radio disturbance for these devices.

● Others

- (1) Do not rapidly and repeatedly insert and disconnect the USB connector on the USB-Serial Conversion Cable. The computer may operate incorrectly.
- (2) The personal computer requires time to recognize the cable connection after the USB connector is connected to the personal computer. This delay does not indicate failure. Check the COM port number before starting communications.
- (3) Do not connect to a personal computer through a USB hub. The USB-Serial Conversion Cable may malfunction.
- (4) Do not extend the USB cable with an extension cable to connect to the personal computer. The USB-Serial Conversion Cable may malfunction.

Preparations for Use

Be sure to thoroughly read and understand the manual provided with the product, and check the following points.

Timing	Check point	Details
Purchasing the product	Product appearance	After purchase, check that the product and packaging are not dented or otherwise damaged. Damaged internal parts may prevent optimum control.
	Product model and specifications	Make sure that the purchased product meets the required specifications.
Setting the Unit	Product installation location	Provide sufficient space around the product for heat dissipation. Do not block the vents on the product.
Wiring	Terminal wiring	Do not subject the terminal screws to excessive stress (force) when tightening them. Make sure that there are no loose screws after tightening terminal screws to the specified torque of 0.43 to 0.58 N·m.
		Be sure to confirm the polarity for each terminal before wiring the terminal block and connectors.
		For the E5□D-B (models with Push-In Plus terminal blocks), do not attempt to wire anything to the release holes.
		For the E5□D-B (models with Push-In Plus terminal blocks), use crossover wiring only for the input power supply and communications. Do not exceed the maximum number of Digital Controllers given below if you use crossover wiring for the input power supply. 100 to 240 VAC Controllers: 16 max. 24 VAC/VDC Controllers: 8 max.
	Power supply inputs	Wire the power supply inputs correctly. Incorrect wiring will result in damage to the internal circuits.
Operating environment	Ambient temperature	The ambient operating temperature for the Digital Controller is –10 to 55°C (with no condensation or icing). To extend the service life of the product, install it in a location with an ambient temperature as low as possible. In locations exposed to high temperatures, if necessary, cool the products using a fan or other cooling method.
	Vibration and shock	Check whether the standards related to shock and vibration are satisfied at the installation environment. (Install the product in locations where the contactors will not be subject to vibration or shock.)
	Foreign particles	Install the product in a location that is not subject to liquid or foreign particles entering the product.

Versions

Check the version on the nameplate on the E5□D Digital Controller or on the label on the packing box.

Product nameplate	Package label
<p>The version is given here.</p>	<p>The version is given here.</p>

Revision History

A manual revision code appears as a suffix to the catalog number on the front cover of the manual.

Cat. No.	H224-E1-04
----------	-------------------

↑
Revision code

Revision code	Date	Revised content
01	March 2017	Original production
02	October 2017	<ul style="list-style-type: none">• Added E5CD-B and E5ED-B.• Added models with linear current outputs.
03	March 2018	Added precautions for wiring of screw terminal block types.
04	September 2022	Added information on <i>Safety Precautions</i> .

Conventions Used in This Manual

Model Notation

“E5□D” is used to indicate information that is the same for the E5CD and E5ED Digital Controllers.

“E5□D-B” is used to indicate information that is the same for the E5CD-B and E5ED-B Digital Controllers.

Meanings of Abbreviations

The following abbreviations are used in parameter names, figures, and other descriptions. These abbreviations mean the following:

Symbol	Term
PV	Process value
SP	Set point
SV	Set value
AT	Auto-tuning
EU	Engineering unit*
LBA	Loop burnout alarm
HB	Heater burnout
HS	Heater short

* “EU” stands for Engineering Unit. EU is used as the minimum unit for engineering units such as °C, m, and g. The size of the EU depends on the input type. For example, when the input temperature setting range is –200 to 1,300°C, 1 EU is 1°C, and when the input temperature setting range is –20.0 to 500.0°C, 1 EU is 0.1°C. For analog inputs, the size of the EU depends on the decimal point position of the scaling setting, and 1 EU is the minimum scaling unit.

000 : Functions with this mark can be used only with the E5□D-□-0□□.

MASK : Parameters with this mark can be used with either the E5□D-□-0□□ or E5□D-□-8□□, but they are masked with the default settings.

MASK8 : Parameters with this mark can be used with the E5□D-□-8□□, but they are masked with the default settings.

Refer to *5-12 Hiding and Displaying Parameters* on page 5-46 for information on displaying parameters that are masked.

Terminology

The following term definitions are used in this manual.

system: The control loop, including the Digital Controller.

system fluctuations: Fluctuations in the temperature inside and outside the control loop.

Examples: Deterioration in heaters or other equipment
Seasonal changes in the ambient temperature

How to Read Display Symbols

The following tables show the correspondence between the symbols displayed on the displays and alphabet characters.

<i>R</i>	<i>b</i>	<i>£</i>	<i>d</i>	<i>E</i>	<i>F</i>	<i>G</i>	<i>H</i>	<i>£</i>	<i>J</i>	<i>K</i>	<i>L</i>	<i>M</i>
A	B	C	D	E	F	G	H	I	J	K	L	M

<i>N</i>	<i>o</i>	<i>P</i>	<i>Q</i>	<i>R</i>	<i>S</i>	<i>t</i>	<i>U</i>	<i>V</i>	<i>W</i>	<i>X</i>	<i>Y</i>	<i>Z</i>
N	O	P	Q	R	S	T	U	V	W	X	Y	Z

How This Manual is Organized

Goal	Related sections	Contents
Learning about the appearance, features, functions, and model numbers	<i>Section 1 Introduction</i>	---
Setting up the E5□D	<i>Section 2 Preparations</i>	This section describes the steps that are required before turning ON the power supply (including installation, terminal usage, wiring, and isolation/insulation block diagram). It also describes how to use the Setup Tool ports.
Learning the basic procedures from turning ON the power supply to starting actual operation	<i>Section 3 Part Names and Basic Procedures</i>	This section serves as a basic tutorial for first-time users of the E5□D.
Learning the basic operating methods	<i>Section 4 Basic Operation</i> <i>Section 6 Parameters</i>	These sections describe basic operating methods.
Learning advanced operating methods	<i>Section 5 Advanced Operations</i> <i>Section 6 Parameters</i>	These sections describe advanced operating methods.
Calibrating the E5□D	<i>Section 7 User Calibration</i>	This section describes the procedures that you can use to calibrate the sensor or transfer output of the E5□D.
Learning the specifications and parameters of the E5□D	<i>Appendices</i>	---

Related Manuals

Also refer to the *E5□D Digital Controllers Communications Manual* (Cat. No. H225) for information on communications.

Sections in this Manual

1	Introduction	1
2	Preparations	2
3	Part Names and Basic Procedures	3
4	Basic Operation	4
5	Advanced Operations	5
6	Parameters	6
7	User Calibration	7
A	Appendices	A
I	Index	I

CONTENTS

Preface	1
Terms and Conditions Agreement.....	2
Warranty, Limitations of Liability	2
Application Considerations	3
Disclaimers	3
Safety Precautions	4
Definition of Precautionary Information	4
Symbols	4
Precautions for Safe Use.....	8
Precautions for Correct Use.....	11
Preparations for Use	13
Versions	14
Revision History	15
Conventions Used in This Manual.....	16
Model Notation	16
Meanings of Abbreviations	16
Terminology	16
How to Read Display Symbols	17
How This Manual is Organized	17
Related Manuals	17
Sections in this Manual	19

Section 1 Introduction

1-1 Appearance, Features, and Functions of the E5□D.....	1-2
1-1-1 Appearance.....	1-2
1-1-2 Features.....	1-2
1-1-3 Main Functions.....	1-5
1-2 I/O Configuration and Model Number Legend	1-7
1-2-1 I/O Configuration	1-7
1-2-2 Model Number Legends.....	1-8

Section 2 Preparations

2-1 Installation.....	2-2
2-1-1 Dimensions (Unit: mm).....	2-2
2-1-2 Panel Cutout (Unit: mm).....	2-4
2-1-3 Mounting	2-5
2-1-4 Drawing Out the Interior Body of the Digital Controller to Replace It.....	2-7
2-2 Using the Terminals	2-9
2-2-1 E5CD Terminal Block Wiring Example.....	2-9
2-2-2 E5CD-B Terminal Block Wiring Example	2-13
2-2-3 E5ED Terminal Block Wiring Example.....	2-17
2-2-4 E5ED-B Terminal Block Wiring Example	2-21
2-2-5 Precautions when Wiring	2-25

2-2-6	Wiring.....	2-28
2-3	Installing Temperature Sensors for Packing Machines.....	2-36
2-4	Insulation Block Diagrams	2-38
2-5	Using the Setup Tool Port	2-39
2-5-1	Procedure	2-39
2-5-2	Connection Method.....	2-39
2-5-3	Installing the Driver	2-42

Section 3 Part Names and Basic Procedures

3-1	Basic Flow of Operation	3-2
3-2	Power ON	3-3
3-3	Part Names, Part Functions, and Setting Levels.....	3-4
3-3-1	Part Names and Functions	3-4
3-3-2	Entering Numeric Values	3-7
3-3-3	Setting Levels	3-8
3-4	Procedures after Turning ON the Power Supply	3-11
3-4-1	Basic Flow of Operations.....	3-11
3-4-2	Basic Procedure	3-11

Section 4 Basic Operation

4-1	Moving between Setting Levels	4-3
4-1-1	Moving to the Initial Setting Level.....	4-3
4-1-2	Moving to the Adjustment Level.....	4-4
4-1-3	Moving to the Protect Level	4-4
4-1-4	Moving to the Advanced Function Setting Level.....	4-5
4-1-5	Moving to the Communications Setting Level.....	4-7
4-2	Initial Setting Examples	4-8
4-3	Setting the Input Type.....	4-11
4-3-1	Input Type.....	4-11
4-4	Selecting the Temperature Unit	4-13
4-4-1	Temperature Unit.....	4-13
4-5	Selecting PID Control or ON/OFF Control.....	4-14
4-6	Setting Output Specifications	4-15
4-6-1	Control Period.....	4-15
4-6-2	Direct and Reverse Operation	4-15
4-6-3	Assigned Output Functions.....	4-16
4-6-4	Auxiliary Output Opening or Closing in Alarm	4-19
4-7	Setting the Set Point (SP)	4-20
4-7-1	Changing the SP.....	4-20
4-8	Using ON/OFF Control	4-21
4-8-1	ON/OFF Control.....	4-21
4-8-2	Settings.....	4-22
4-9	Determining PID Constants (AT, Manual Setup)	4-24
4-9-1	AT (Auto-tuning)	4-24
4-9-2	RT (Robust Tuning) (Use with AT)	4-27
4-9-3	Manual Setup.....	4-29
4-10	Alarm Outputs.....	4-31
4-10-1	Alarm Types.....	4-31
4-10-2	Alarm Values	4-34
4-11	Alarm Hysteresis	4-37
4-11-1	Standby Sequence	4-37

4-11-2	Alarm Latch	4-38
4-12	Using Heater Burnout (HB) and Heater Short (HS) Alarms	4-39
4-12-1	HB Alarm	4-39
4-12-2	HS Alarm	4-41
4-12-3	Installing Current Transformers (CT)	4-43
4-12-4	Calculating Detection Current Values	4-44
4-12-5	Application Examples	4-44
4-13	Customizing the PV/SP Display	4-46
4-13-1	PV/SP Display Selections	4-46

Section 5 **Advanced Operations**

5-1	Suppressing Temperature Variations When Using a Temperature Sensor for Packing Machines (for Packing Machines)5-3	
5-2	Automatically Adjusting a Water-cooling Output (for Water-cooled Extruders)	5-7
5-3	Performing Adaptive Control.....	5-11
5-3-1	Overview	5-11
5-3-2	Application Methods for Adaptive Control	5-19
5-4	Indication Data	5-21
5-5	Shifting Input Values	5-25
5-6	Setting Scaling Upper and Lower Limits for Analog Inputs	5-27
5-7	Executing Heating/Cooling Control	5-29
5-7-1	Heating/Cooling Control	5-29
5-8	Using Event Inputs	5-33
5-8-1	Event Input Settings	5-33
5-8-2	How to Use the Multi-SP Function	5-33
5-8-3	Operation Commands Other than Multi-SP	5-35
5-9	Setting the SP Upper and Lower Limit Values.....	5-39
5-9-1	Set Point Limiter	5-39
5-9-2	Setting	5-40
5-10	Using the SP Ramp Function to Limit the SP Change Rate	5-41
5-10-1	SP Ramp	5-41
5-11	Using the Key Protect Level	5-43
5-11-1	Protection	5-43
5-11-2	Entering the Password to Move to the Protect Level	5-44
5-12	Hiding and Displaying Parameters	5-46
5-12-1	Parameter Mask Setting.....	5-46
5-13	OR Output of Alarms	5-49
5-13-1	Integrated Alarm.....	5-49
5-14	Alarm Delays	5-51
5-14-1	Alarm Delays	5-51
5-15	Loop Burnout Alarm.....	5-53
5-15-1	Loop Burnout Alarm (LBA)	5-53
5-16	Performing Manual Control	5-56
5-16-1	Manual MV	5-56
5-17	Using the Simple Program Function.....	5-59
5-17-1	Simple Program Function.....	5-59
5-17-2	Operation at the Program End	5-62
5-17-3	Application Example Using a Simple Program.....	5-64
5-18	Output Adjustment Functions	5-65
5-18-1	Output Limits	5-65
5-18-2	MV at Stop	5-65
5-18-3	MV at PV Error	5-65

5-19	Using the Extraction of Square Root Parameter	5-67
5-19-1	Extraction of Square Roots.....	5-67
5-20	Setting the Width of MV Variation	5-69
5-20-1	MV Change Rate Limit.....	5-69
5-21	Setting the PF Key	5-70
5-21-1	PF Setting (Function Key)	5-70
5-22	Displaying PV/SV Status	5-73
5-22-1	PV and SV Status Display Functions.....	5-73
5-23	Logic Operations	5-75
5-23-1	The Logic Operation Function (CX-Thermo)	5-75
5-23-2	Using Logic Operations	5-75
5-24	Initializing Settings	5-84
5-25	Setting the Operating Status to Use When Power Is Turned ON	5-85
5-26	Using the Transfer Output for the Process Value, Set Point, or other Data	5-86
5-26-1	Transfer Output Function.....	5-86

Section 6 Parameters

6-1	Conventions Used in this Section	6-2
6-2	Protect Level	6-3
6-3	Operation Level	6-7
6-4	Adjustment Level.....	6-16
6-5	Monitor/Setting Item Level.....	6-37
6-6	Manual Control Level	6-38
6-7	Initial Setting Level.....	6-40
6-8	Advanced Function Setting Level.....	6-62
6-9	Communications Setting Level.....	6-97

Section 7 User Calibration

7-1	User Calibration.....	7-2
7-2	Parameter Structure	7-3
7-3	Thermocouple Calibration	7-4
7-4	Resistance Thermometer Calibration	7-7
7-5	Calibrating Analog Input	7-9
7-6	Calibrating the Transfer Output	7-13
7-7	Checking Indication Accuracy	7-15

Section A Appendices

A-1	Specifications	A-2
A-1-1	Ratings.....	A-2
A-1-2	Characteristics	A-4
A-1-3	Rating and Characteristics of Options	A-5
A-1-4	Waterproof Packing	A-5
A-1-5	Setup Tool Port Cover for Front Panel	A-6
A-1-6	Draw-out Jig.....	A-7
A-2	Current Transformer (CT)	A-8

A-2-1	Specifications	A-8
A-2-2	Dimensions (Unit: mm).....	A-8
A-3	USB-Serial Conversion Cable and Conversion Cable	A-11
A-3-1	E58-CIFQ2 USB-Serial Conversion Cable.....	A-11
A-3-2	E58-CIFQ2-E Conversion Cable.....	A-12
A-4	Temperature Sensor for Packing Machines.....	A-13
A-4-1	Model Number Legend.....	A-13
A-4-2	Dimensions	A-14
A-4-3	Mounting Brackets	A-15
A-5	Error Displays	A-16
A-6	Troubleshooting	A-20
A-7	Parameter Operation Lists.....	A-23
A-7-1	Operation Level.....	A-23
A-7-2	Adjustment Level.....	A-24
A-7-3	Initial Setting Level.....	A-26
A-7-4	Manual Control Level	A-30
A-7-5	Monitor/Setting Item Level	A-30
A-7-6	Advanced Function Setting Level.....	A-30
A-7-7	Protect Level	A-35
A-7-8	Communications Setting Level.....	A-35
A-7-9	Initialization According to Parameter Changes	A-36
A-8	Sensor Input Setting Range, Indication Range, Control Range.....	A-39
A-9	Setting Levels Diagram	A-40
A-10	Parameter Flow	A-41
A-11	Parameter Flow (For E5□D-□-80□).....	A-43
Index	Index-1	



1

Introduction

1-1	Appearance, Features, and Functions of the E5□D	1-2
1-1-1	Appearance	1-2
1-1-2	Features	1-2
1-1-3	Main Functions	1-5
1-2	I/O Configuration and Model Number Legend	1-7
1-2-1	I/O Configuration	1-7
1-2-2	Model Number Legends	1-8

1-1 Appearance, Features, and Functions of the E5□D

1-1-1 Appearance

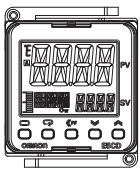

E5CD/E5CD-B

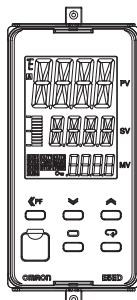

E5ED/E5ED-B

- Functions specialized for packaging machines.
- Functions specialized for water-cooled extruders.
- Automatic optimization of control for system fluctuations.*
- Displays of the heater current or manipulated value on a bar display.
- Various indication data.
- A stylish design that gives a new look to control panels.
- Large display characters and white backlight for better visibility.
- A compact size to help downsize control panels.

* system fluctuations: Fluctuations in the temperature inside and outside the control loop.

Examples: Deterioration in heaters or other equipment
Seasonal changes in the ambient temperature

1-1-2 Features

The E5□D provides the following features.

Temperature Sensors for Packing Machines and Automatic Filter Adjustment

Temperature Sensors for Packing Machines are available and automatic filter adjustment is supported. Mainly, temperature variations in packing machines are suppressed to maintain stable performance.

● Temperature Sensors for Packaging Machines

The temperature of a packing machine is normally controlled by measuring the temperature of a heater that is separate from the sealing section. When that is done, a deviation occurs between the temperature of the seal and the temperature of the heater, which can lead to sealing faults.

To solve this problem, OMRON provides Temperature Sensors for Packing Machines (E52-CA□□A□ D=1 S□, sold separately) that can be used to measure the actual temperature of the seal. You can use these Temperature Sensors to reduce the number of sealing faults caused by this temperature deviation.

● Automatic Filter Adjustment

When controlling the temperature of a packing machine, temperature variations can occur due to periodic disturbances and other factors.

To handle this, you can use the automatic filter adjustment function in the Digital Controller to suppress temperature variations caused by periodic disturbances and other factors.

Particularly if you use the above Temperature Sensors for Packing Machines, the affect of packing material heat increases and the periodic temperature variation becomes apparent. Automatic filter adjustment enables stable control.

We recommend that you use automatic filter adjustment in the following cases.

- If temperature variation occurs when Temperature Sensors for Packing Machines are used even if AT is performed
- If temperature variation occurs after a heater is replaced
- If temperature variation occurs after packing materials are changed or the packing speed is changed
- If temperature variation occurs due to changes in the operating environment

Note: This function cannot be used during ON/OFF control or heating/cooling control.

Water-cooling Output Adjustment

Mainly, temperature variations in water-cooled extruders are suppressed to maintain stable performance.

When hunting occurs in heating/cooling control of water-cooled extruders, it was previously necessary to have a worker skilled in PID adjustment or water-cooled valve adjustment adjust the system.

With water-cooling output adjustment, you can automatically adjust the cooling proportional band to suppress temperature hunting. Because adjustment is performed during operation, optimum control is enabled even during material condition changes.

We recommend that you use water-cooling output adjustment in the following cases.

- If temperature variation occurs due to changes in the water-cooling system
- If temperature variation occurs due to changes in the cooling valve settings
- To reduce the amount of work required to adjust cooling valves

Note: This function cannot be used during any of the following: standard control, an analog input type, any other heating/cooling method (i.e., except for water cooling), direct operation, and SP ramp operation.

Adaptive Control

Adaptive control is a control method that helps to maintain optimum temperature control by following any changes that may occur due to system fluctuations, such as changes in the environment or equipment deterioration.

With adaptive control, AT (auto-tuning) is required only the first time operation is performed. After that, the equipment startup temperature is monitored to detect system fluctuations and update the PID constants for adaptive control.

There is no need to execute AT again or to manually adjust the PID constants, and higher control performance is achieved than is possible with AT alone.

We recommend that you use adaptive control in the following cases.

- To reduce decline in control performance caused by environmental changes or equipment deterioration
- To increase control performance over AT

Note: This function cannot be used during any of the following: heating/cooling control, an analog input type, direct operation, and SP ramp operation.

Various Indication Data

Various indication data is provided to help predict the product service life and replacement period. You can use it in the host system to collect and analyze data and make predictions.

The following data can be read through host communications or checked with key operations on the front panel.

- **Power ON time data:** You can display the total power ON time of the Digital Controller or read it with communications.
The service life of the Digital Controller and equipment depends on the operating environment.
You can collect power ON time data to clarify the relation between the operating environment and service life and use it to predict future machine maintenance periods and to improve the operating environment.
- **Ambient temperature monitor:** You can display the temperature around the terminals or read it with communications. You can monitor trends in the ambient temperature to monitor for abnormal heat generation in the panel.
- **Output relay ON/OFF count monitors:** The contacts in the relays have a service life. You can display the number of relay ON/OFF operations or read it with communications.
You can monitor this data to determine replacement periods before the service life count to make maintenance more efficient.

1-1-3 Main Functions

For details on particular functions and how to use them, refer to *Section 3 Part Names and Basic Procedures* and following sections.

● Input Sensor Types

You can connect the following sensors and signals to the universal input.

Thermocouple (temperature input):	K, J, T, E, L, U, N, R, S, B, C/W, or PL II
Resistance thermometer (temperature input):	Pt100, JPt100
Infrared Temperature Sensor (temperature input):	ES1B
	10 to 70°C, 60 to 120°C, 115 to 165°C, 140 to 260°C
Current input (analog input):	4 to 20 mA DC, 0 to 20 mA DC
Voltage input (analog input):	1 to 5 VDC, 0 to 5 V DC, 0 to 10 V DC

● Control Outputs

- A control output can be a relay output, voltage output (for driving SSR), or linear current output, depending on the model.

● Adjusting PID Constants

- You can easily set the optimum PID constants by performing AT (auto-tuning) with the limit cycle method.
- You can also add RT (robust tuning) to give priority to controlling stability.

● Alarms

Standard Alarms

- You can output an alarm when the deviation, process value, set point, or manipulated value reaches a specified value.
- You can also output alarms for the PV rate of change and for loop burnouts.
- If necessary, a more comprehensive alarm function can be achieved by setting a standby sequence, alarm hysteresis, auxiliary output close in alarm/open in alarm, alarm latch, alarm ON delay, and alarm OFF delay.

HB and HS Alarms

- With models with the optional HB and HS alarms, you can detect heater burnout and heater short alarms based on CT inputs.

Integrated Alarm

- You can output an integrated alarm if a standard alarm, HB alarm, or HS alarm turns ON.

● Event Inputs

- With any model that supports event inputs, you can use external contact or transistor inputs to achieve any of the following functions: Switching set points (Multi-SP No. Switch, 8 points max.), switching RUN/STOP, switching between automatic and manual operation, starting/resetting the program, inverting direct/reverse operation, 100% AT execute/cancel, 40% AT execute/cancel, setting change enable/disable, communications write enable/disable, canceling the alarm latch, PID updating (adaptive control), automatic filter adjustment, and water-cooling output adjustment.

● Communications Functions

With any model that supports communications, you can use communications via CompoWay/F, Modbus-RTU,* or programless communications.

* Modbus is a registered trademark of Schneider Electric.

● Transfer Output

With any model that provides a transfer output, you can output the set point, process value, manipulated variable, or other values as a 4 to 20 mA or 1 to 5 V transfer output.

1-2 I/O Configuration and Model Number Legend

1-2-1 I/O Configuration

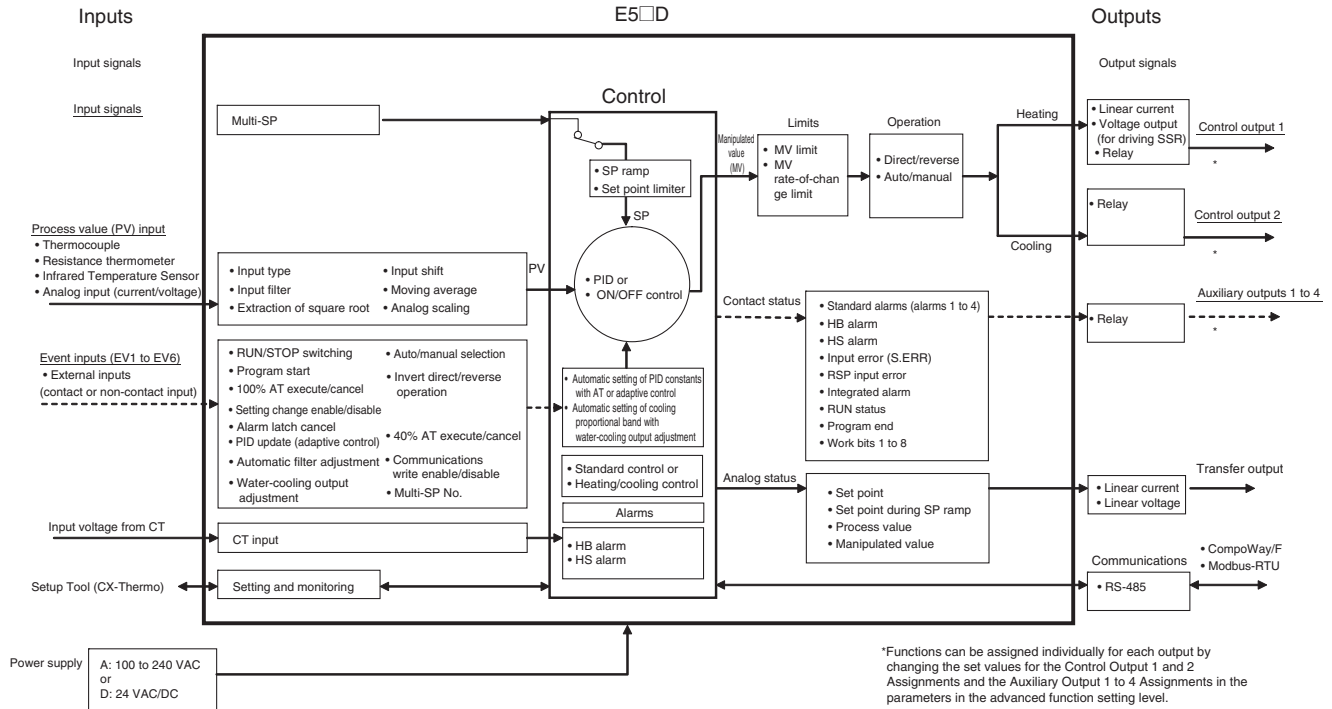

Note: Not all models support these functions. For details, refer to 1-2-2 Model Number Legends.

1-2-2 Model Number Legends

● E5CD (Models with Screw Terminal Blocks)

000

E5 C D - 6 - 0

(1) (2) (3) (4) (5) (6) (7)

(1)	(2)	(3)	(4)	(5)	(6)	(7)	Meaning			
Size	Control Outputs 1 and 2	No. of auxiliary outputs	Power supply voltage	Terminal type	Input type	Options				
C							48 × 48 mm			
							Control output 1		Control output 2	
	R	X					Relay output		None	
	Q	X					Voltage output (for driving SSR)		None	
	C	X					Linear current output		None	
			2				2			
				A			100 to 240 VAC			
				D			24 VAC/DC			
					6		Screw terminals (with Cover: E53-COV23) Draw-out model			
						M	Universal input			
							Event inputs	Communi- cations	HB alarm and HS alarm	Transfer output
						000	---			
					*1	001	2	---	1	---
					*1	002	---	RS-485	1	---
					*2	004	2	RS-485	---	
					*2	006	2	---		Provided

*1 You can select option 001 or 002 if RX and QX control outputs are selected.

*2 You can select option 004 or 006 if CX control outputs are selected.

E 5 **C** **D** - **D** - **8**

(1) (2) (3) (4) (5) (6) (7)

(1)	(2)	(3)	(4)	(5)	(6)	(7)	Meaning			
Size	Control Outputs 1 and 2		No. of auxiliary outputs	Power supply voltage	Terminal type	Input type	Options			
C							48 × 48 mm			
							Control output 1		Control output 2	
	R	X					Relay output		None	
	Q	X					Voltage output (for driving SSR)		None	
	C	X					Linear current output		None	
			2				2			
				A			100 to 240 VAC			
				D			24 VAC/DC			
					D		Screw terminals (no cover) Draw-out model			
						M	Universal input			
							Event inputs	Communications	HB alarm and HS alarm	
							800	---		
						*1	802	---	RS-485	1
						*2	804	---	RS-485	1

*1 You can select option 802 if RX and QX control outputs are selected.

*2 You can select option 804 if CX control outputs are selected.

● E5CD-B (Models with Push-In Plus Terminal Blocks)

000

E 5 **C** D - **B** - **0**

(1) (2) (3) (4) (5) (6) (7)

(1)	(2)	(3)	(4)	(5)	(6)	(7)	Meaning			
Size	Control Outputs 1 and 2	No. of auxiliary outputs	Power supply voltage	Terminal type	Input type	Options				
C							48 × 48 mm			
							Control output 1		Control output 2	
	R	X					Relay output		None	
	Q	X					Voltage output (for driving SSR)		None	
	C	X					Linear current output		None	
		2					2 (one common)			
			A				100 to 240 VAC			
			D				24 VAC/DC			
				B			Push-In Plus terminal blocks			
					M		Universal input			
							Event inputs	Communi- cations	HB alarm and HS alarm	Transfer output
						000	---		---	
					*1	001	2	---	1	---
					*1	002	---	RS-485	1	---
					*2	004	2	RS-485	---	
					*2	006	2	---	---	Provided

*1 You can select option 001 or 002 if RX and QX control outputs are selected.

*2 You can select option 004 or 006 if CX control outputs are selected.

E 5 **C** D - [] [] [] [] **B** [] - **8** [] []
 (1) (2) (3) (4) (5) (6) (7)

(1)	(2)	(3)	(4)	(5)	(6)	(7)	Meaning		
C							48 × 48 mm		
							Control output 1		Control output 2
	R	X					Relay output		None
	Q	X					Voltage output (for driving SSR)		None
*1	C	X					Linear current output		None
		2					2 (one common)		
			A				100 to 240 VAC		
			D				24 VAC/DC		
				B			Push-In Plus terminal blocks		
					M		Universal input		
							Event inputs	Communications	HB alarm and HS alarm
						800	---		---
					*1	802	---	RS-485	1
					*2	804	---	RS-485	1

*1 You can select option 802 if RX and QX control outputs are selected.
 *2 You can select option 804 if CX control outputs are selected.

● E5ED (Models with Screw Terminal Blocks)

000

E 5 E D - 6 - 0

(1) (2) (3) (4) (5) (6) (7)

(1)	(2)	(3)	(4)	(5)	(6)	(7)	Meaning			
Size	Control Outputs 1 and 2	No. of auxiliary outputs	Power supply voltage	Terminal type	Input type	Options				
E							48 × 96 mm			
							Control output 1		Control output 2	
	R X						Relay output		None	
	Q X						Voltage output (for driving SSR)		None	
	C X						Linear current output		None	
	Q R						Voltage output (for driving SSR)		Relay output	
	R R						Relay output		Relay output	
		4					4			
			A				100 to 240 VAC			
			D				24 VAC/DC			
				6			Screw terminals (with Cover: E53-COV24) Draw-out model			
					M		Universal input			
							Event inputs	Communication s	HB alarm and HS alarm	Transfer output
						000	---			---
						*1 004	2	RS-485		---
						*2 008	2	RS-485	1	---
						*3 010	4	---	1	---
						*1 022	4	RS-485	---	Provided

- *1 You can select option 004 or 022 if CX control outputs are selected.
- *2 You can select option 008 if RX, QX, QR or RR control outputs are selected.
- *3 You can select option 010 if RX or QX control outputs are selected.

E 5 **E** D - [] [] [] [] **D** [] - **8** [] []

(1) (2) (3) (4) (5) (6) (7)

(1)	(2)	(3)	(4)	(5)	(6)	(7)	Meaning		
E							48 × 96 mm		
							Control output 1		Control output 2
	R	X					Relay output		None
	Q	X					Voltage output (for driving SSR)		None
	C	X					Linear current output		None
		2					2		
			A				100 to 240 VAC		
			D				24 VAC/DC		
				D			Screw terminals (no cover) Draw-out model		
					M		Universal input		
							Event inputs	Communications	HB alarm and HS alarm
						800	---		
					*1	804	2	RS-485	1
					*2	808	2	RS-485	---

*1 You can select option 804 if RX and QX control outputs are selected.

*2 You can select option 808 if CX control outputs are selected.

E 5 **E** D - [] [] [] [] **B** [] - **8** [] []

(1) (2) (3) (4) (5) (6) (7)

(1)	(2)	(3)	(4)	(5)	(6)	(7)	Meaning		
E							48 × 96 mm		
							Control output 1		Control output 2
	R	X					Relay output		None
	Q	X					Voltage output (for driving SSR)		None
	C	X					Linear current output		None
			2				2		
				A			100 to 240 VAC		
				D			24 VAC/DC		
					B		Push-In Plus terminal blocks		
						M	Universal input		
							Event inputs	Communications	HB alarm and HS alarm
						800	---		
					*1	804	2	RS-485	---
					*2	808	2	RS-485	1

*1 You can select option 804 if RX or QX control outputs are selected.

*2 You can select option 808 if CX control outputs are selected.

2

Preparations

2-1	Installation	2-2
2-1-1	Dimensions (Unit: mm)	2-2
2-1-2	Panel Cutout (Unit: mm)	2-4
2-1-3	Mounting	2-5
2-1-4	Drawing Out the Interior Body of the Digital Controller to Replace It	2-7
2-2	Using the Terminals	2-9
2-2-1	E5CD Terminal Block Wiring Example	2-9
2-2-2	E5CD-B Terminal Block Wiring Example	2-13
2-2-3	E5ED Terminal Block Wiring Example	2-17
2-2-4	E5ED-B Terminal Block Wiring Example	2-21
2-2-5	Precautions when Wiring	2-25
2-2-6	Wiring	2-28
2-3	Installing Temperature Sensors for Packing Machines	2-36
2-4	Insulation Block Diagrams	2-38
2-5	Using the Setup Tool Port 000	2-39
2-5-1	Procedure	2-39
2-5-2	Connection Method	2-39
2-5-3	Installing the Driver	2-42

2-1 Installation

2-1-1 Dimensions (Unit: mm)

● E5CD

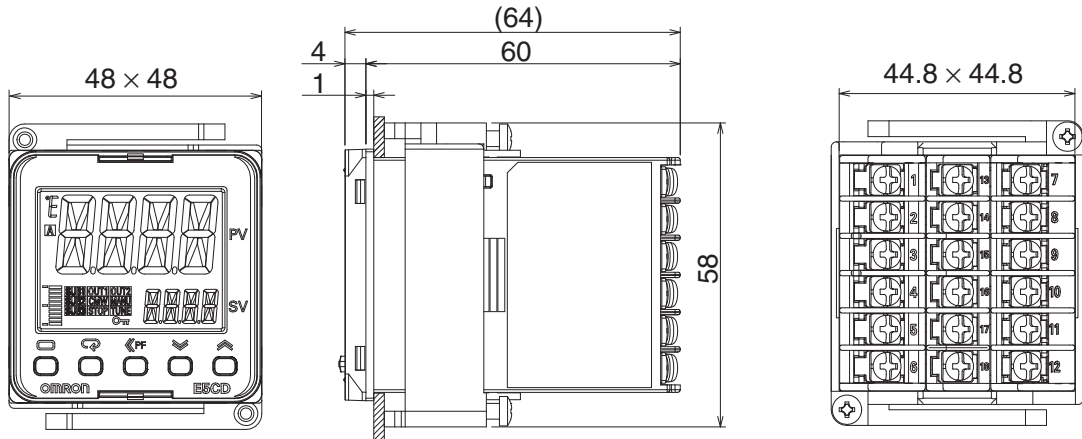

● E5CD-B

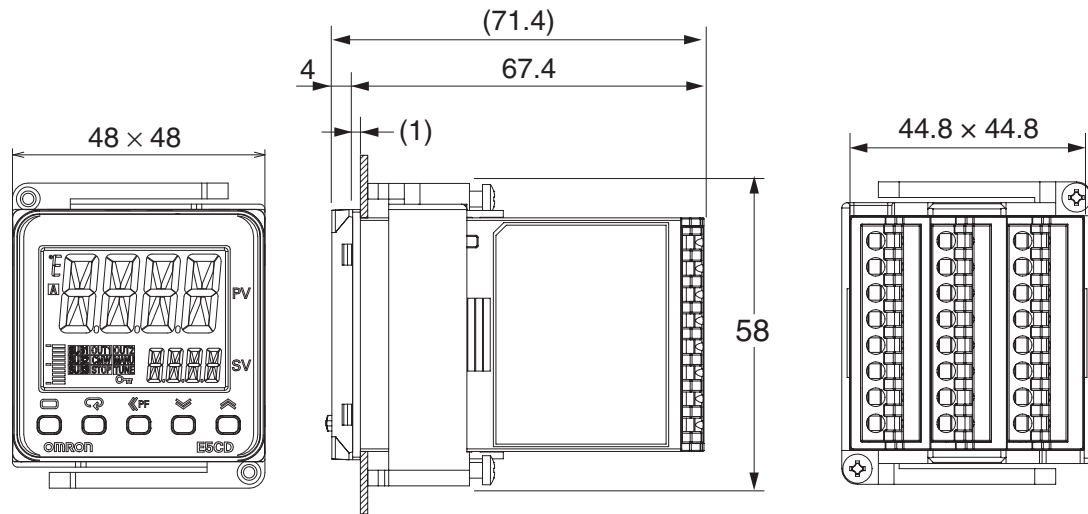

● E5ED

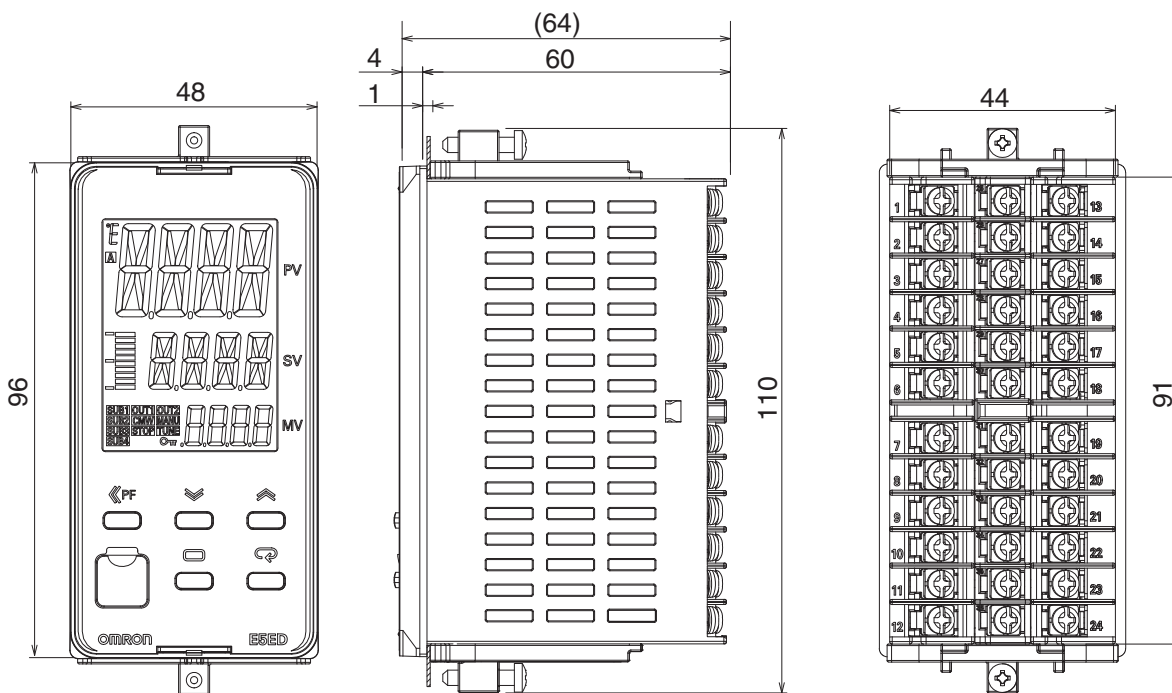

* The E5ED-□-8□□ does not have a tool port (i.e., a pin jack) on the front.

● E5ED-B

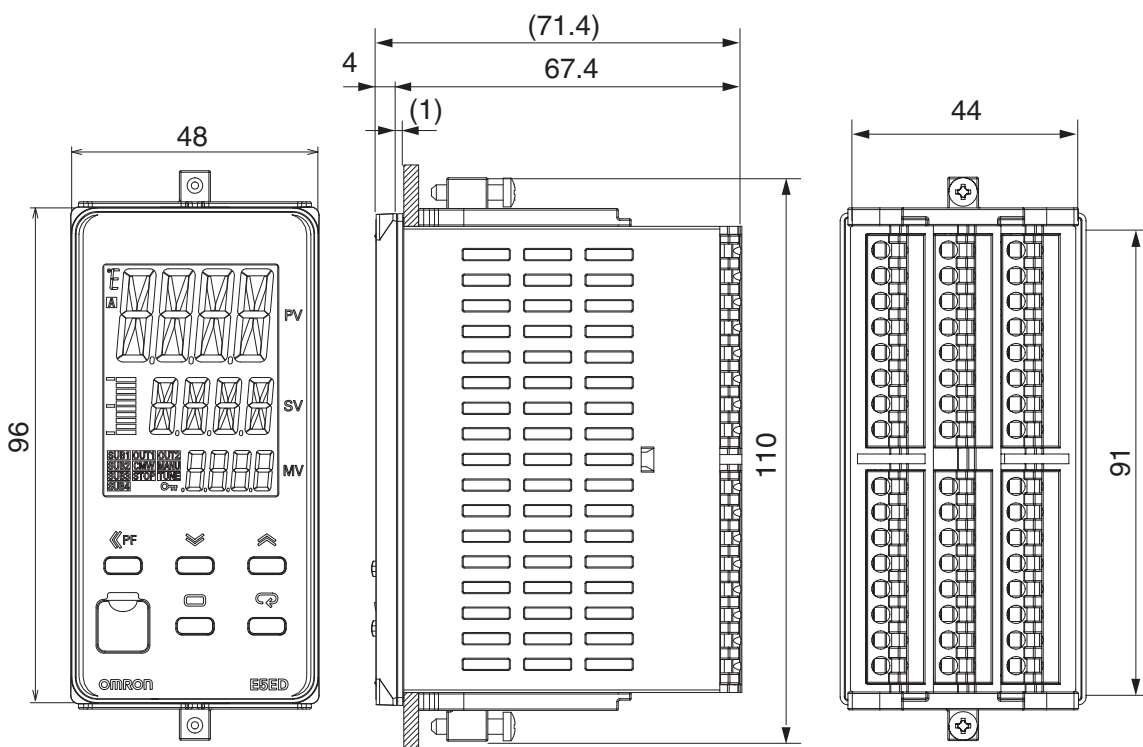

2-1-2 Panel Cutout (Unit: mm)

● E5CD/E5CD-B

Individual Mounting

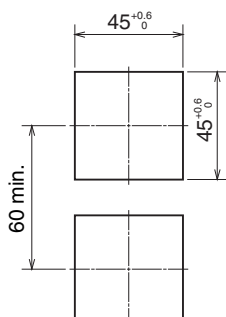

Group Mounting

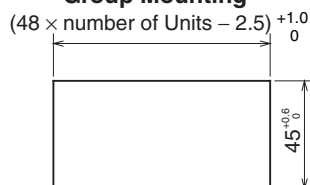

● E5ED/E5ED-B

Individual Mounting

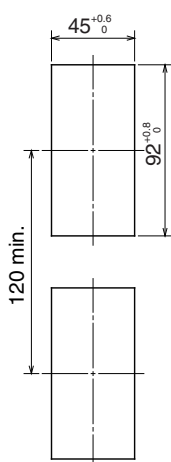

Group Mounting*1

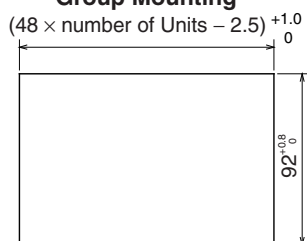

- Waterproofing is not possible when group mounting several Digital Controllers.
- The recommended panel thickness is 1 to 5 mm for the E5CD and E5CD-B and 1 to 8 mm for E5ED and E5ED-B.
- Digital Controllers must not be group mounting vertically. (Observe the recommended mounting space limits.)
- When two or more Digital Controllers are mounted, make sure that the ambient temperature of the Digital Controllers does not exceed the allowable operating temperature specified in the specifications.

2-1-3 Mounting

● E5CD/E5CD-B

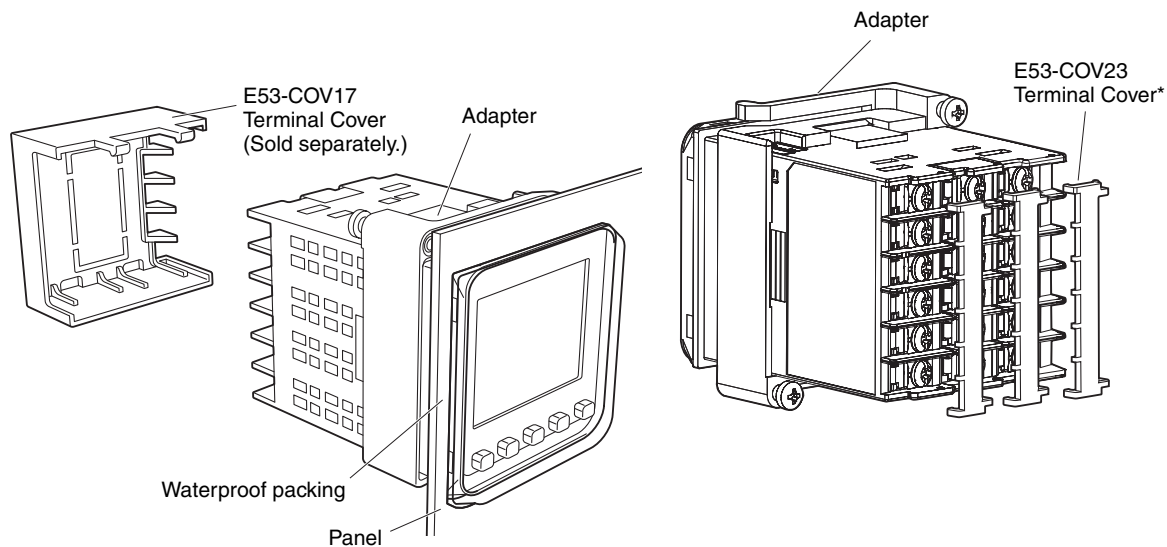

Mounting to the Panel (E5CD or E5CD-B)

- (1) For waterproof mounting, waterproof packing must be installed on the Digital Controller. Waterproofing is not possible when group mounting several Digital Controllers.
- (2) Insert the E5CD or E5CD-B into the mounting hole in the panel.
- (3) Push the Adapter from the terminals up to the panel, and temporarily fasten the E5CD.
- (4) Tighten the two fastening screws on the Adapter. Alternately tighten the two screws little by little to maintain a balance. Tighten the screws to a torque of 0.29 to 0.39 N·m.

Mounting the Terminal Cover (E5CD Only)

There are two models of Terminal Covers that you can use with the E5CD.

Slightly bend the E53-COV23 Terminal Cover to attach it to the terminal block as shown in the following diagram. The Terminal Cover cannot be attached in the opposite direction. Or, you can use the E53-COV17 Terminal Cover. Make sure that the "UP" mark is facing up, and then attach the E53-COV17 Terminal Cover to the holes on the top and bottom of the Digital Controller. (The E53-COV23 Terminal Cover is not provided with the E5CD-□-8□□.)

● E53-COV17

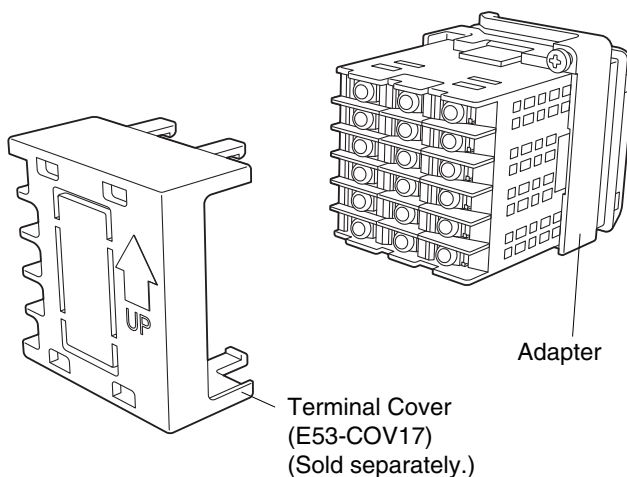

● E53-COV23

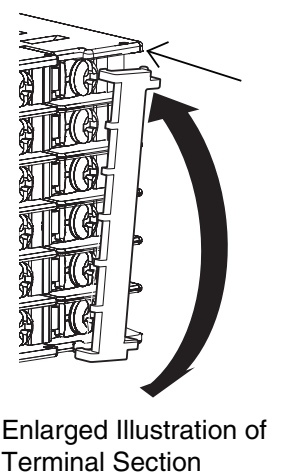

● E5ED/E5ED-B

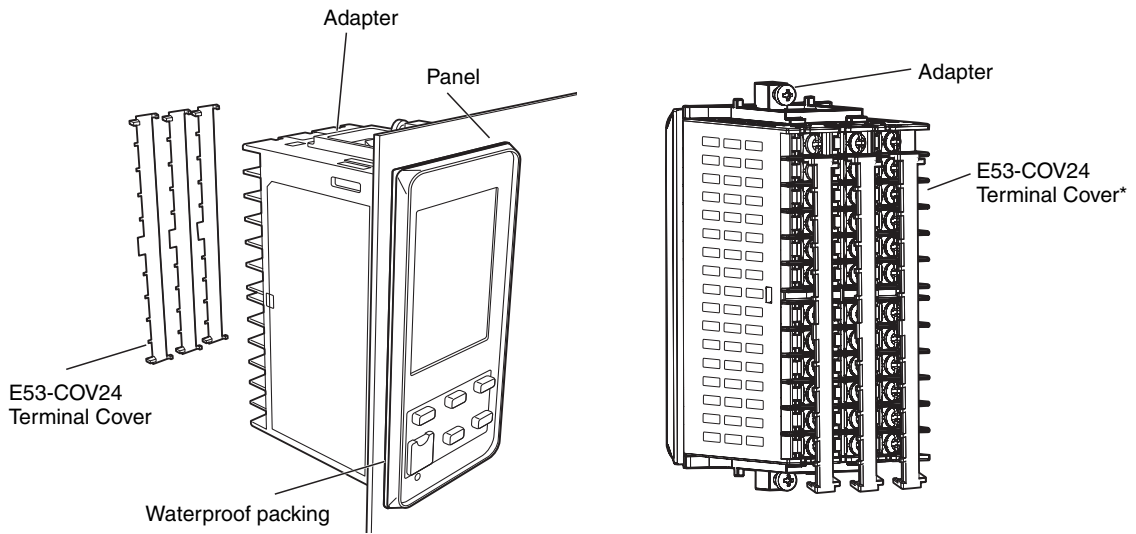

Mounting to the Panel (E5ED or E5ED-B)

- (1) For waterproof mounting, waterproof packing must be installed on the Digital Controller. Waterproofing is not possible when group mounting several Digital Controllers.
- (2) Insert the E5ED or E5ED-B into the mounting hole in the panel.
- (3) Push the Adapter from the terminals up to the panel, and temporarily fasten the E5ED.
- (4) Tighten the two fastening screws on the Adapter. Alternately tighten the two screws little by little to maintain a balance. Tighten the screws to a torque of 0.29 to 0.39 N·m.

Mounting the Terminal Cover (E5ED Only)

Slightly bend the E53-COV24 Terminal Cover to attach it to the terminal block as shown in the following diagram. The Terminal Cover cannot be attached in the opposite direction. (The E53-COV24 Terminal Cover is not provided with the E5ED-□-8□□.)

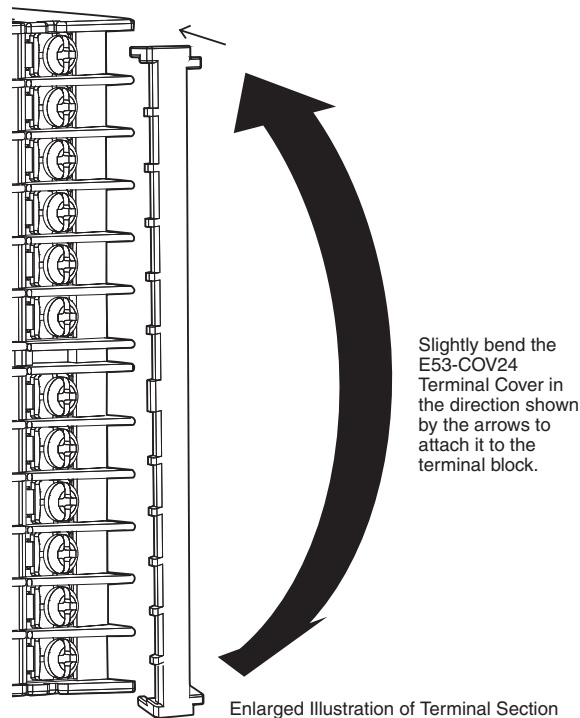

2-1-4 Drawing Out the Interior Body of the Digital Controller to Replace It

You can use the Draw-out Jig to remove the interior body of the Digital Controller from the case to perform maintenance without removing the terminal leads. Use the Y92F-58 Draw-out Jig for the E5CD and the Y92F-59 Draw-out Jig for the E5ED. Check the specifications of the case and Digital Controller before removing the interior body from the case. (The E5□D-B cannot be removed the interior body from the case.)

1 Draw out the interior body from the rear case.

- (1) Align the arms on the Draw-out Jig with the top of the front panel on the Digital Controller and position it vertically.
(The Y92F-58 is shown in the figure.)

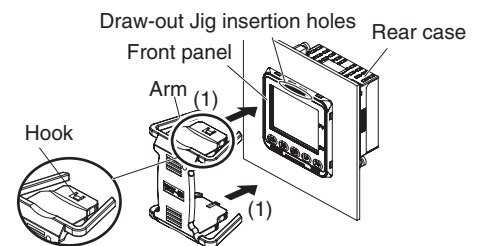

- (2) Align the hooks on the Draw-out Jig with the Draw-out Jig insertion holes on the Digital Controller and slowly insert the Draw-out Jig into the Draw-out Jig insertion holes laterally until it clicks into place. (If you attempt to draw out the interior body of the Digital Controller when only one hook is engaged, the Digital Controller may be damaged.)
(The Y92F-58 is shown in the figure.)

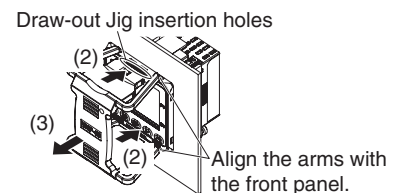

- (3) Pull out the Draw-out Jig together with the front panel. Do not pull with excessive force. Slowly pull out the Digital Controller laterally. (If you pull the interior body out at an angle, the Digital Controller may be damaged.)
- (4) After the interior body is free from the rear case, support the interior body with one hand and pull it out slowly in a horizontal direction.

2 Prepare the new interior body.

- (1) Place the Digital Controller flat on a table and slowly insert the Draw-out Jig into the Draw-out Jig insertion holes laterally until it clicks into place. (There is a hole at both the top and bottom.)
(The E5CD is shown in the figure.)
- (2) Place the Digital Controller on a table facing upward.
- (3) Hold the rear case with your hand and slowly draw out the interior body in a vertical direction. If you draw out the interior body horizontally while holding the Digital Controller in your hand, the interior body will fall and may be damaged.

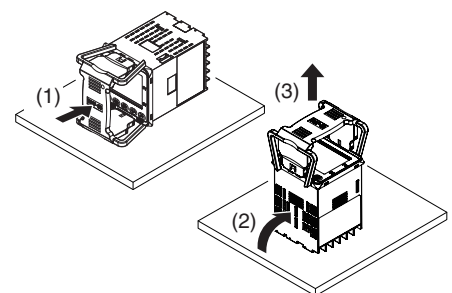

3 Insert the new interior body into the rear case.

- (1) When inserting the interior body back into the rear case, mount the sealing rubber in the position shown on the right, make sure the PCBs are parallel to each other, and press the interior body toward the rear case and into position, making sure that the sealing rubber does not move.

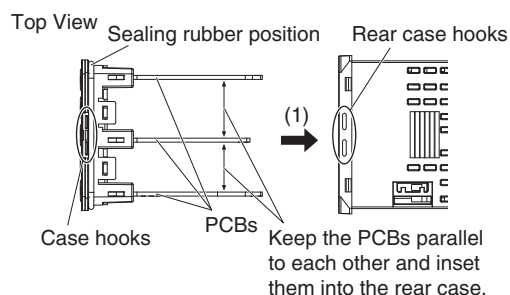

- (2) When you press the Digital Controller into position, press down on the rear case hooks so that the case hooks securely lock in place. (There are rear case hooks at both the top and bottom of the rear case.) If the Digital Controller is not correctly mounted into the rear case, the rear case may not be waterproof. When inserting the Digital Controller, do not allow the electronic components to touch the rear case. (The E5CD is shown in the figure.)

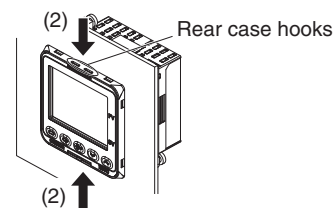

Additional Information

Removing the draw-out jig when only one hook is caught in the draw-out jig insertion hole

- (1) Pull the Draw-out Jig slowly in the direction shown in the figure. (This step is the same even if the other hook is caught.)
- (2) Confirm that the Draw-out Jig is free of the Draw-out Jig insertion hole.
- (3) If the interior body separates from the rear case, slowly press the interior body into the rear case in a horizontal direction. (The E5CD is shown in the figure.) If you do not follow the procedures above, the Digital Controller may be damaged.

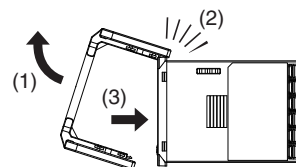

2-2 Using the Terminals

2-2-1 E5CD Terminal Block Wiring Example

● Terminal Arrangement

The terminals block of the E5CD is divided into five types of terminals: control output 1, sensor input, auxiliary outputs, input power supply, and options.

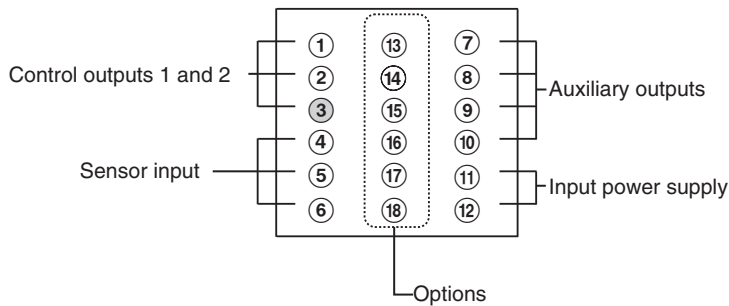

Precautions for Correct Use

When you purchase the Digital Controller, it will be set for a K thermocouple (input type = 5) by default. If a different sensor is used, an input error (*5.ERR*) will occur. Check the setting of the Input Type parameter.

Control Output 1

● Model Numbers

The control output 1 specification of the E5CD is given in the following location in the model number.

E5CD-□□ □ □ □ M-□□□□

Control outputs 1 and 2

Code	Output type	Specification
RX	1 relay output	250 VAC, 3 A (resistive load)
QX	1 voltage output (for driving SSR)	12 VDC, 21 mA
CX	1 linear current output 4 to 20 mA DC or 0 to 20 mA	DC with load of 500 Ω max.

● Terminal Details

Do not connect anything to the terminals that are shaded gray.

RX	QX	CX
<p>Control output 1</p> <p>Relay output</p>	<p>Control output 1</p> <p>Voltage output (for driving SSR)</p>	<p>Control output 1</p> <p>Linear current output</p>

Sensor Input

● Model Numbers

All E5CD models have universal sensor inputs, so the code in the model number is always "M."

E5CD-□□ □ □ □ M-□□□□

└── Sensor input

● Terminal Details

Do not connect anything to the terminals that are shaded gray.

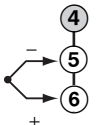
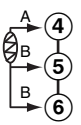
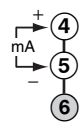
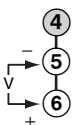
TC (thermocouple)	Pt (resistance thermometer)	I (current)	V (voltage)
			



Precautions for Correct Use

- When complying with EMC standards, the line connecting the sensor must be 30 m or less. If the cable length exceeds 30 m, compliance with EMC standards will not be possible.
- The sensor input is not electrically isolated from the internal circuits. If you use a grounded thermocouple, do not connect one of the sensor input terminals to ground. (If the sensor input terminals are connected to ground, errors will occur in the measured temperature as a result of leakage current.)

Auxiliary Outputs

● Model Numbers

The number of auxiliary outputs on the E5CD is given in the following location in the model number.

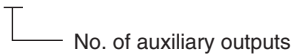
E5CD-□□ □ □ □ M-□□□□

 No. of auxiliary outputs

Code	Auxiliary outputs	Specification
2	Model with 2 auxiliary outputs	SPST-NO, 250 VAC, 3 A

● Terminal Details

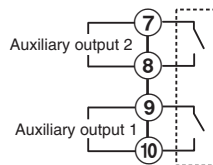
Model with 2 auxiliary outputs



Input Power Supply

● Model Numbers

The input power supply specification of the E5CD is given in the following location in the model number.

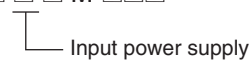
E5CD-□□ □ □ □ M-□□□□

 Input power supply

Code	Specification	Power consumption
A	100 to 240 VAC, 50/60 Hz	Option number 000 or 800: 5.2 VA max. Other option numbers: 6.5 VA max.
D	24 VAC, 50/60 Hz 24 VDC (no polarity)	Option number 000 or 800: 3.1 VA max./1.6 W max. Other option numbers: 4.1 VA max./2.3 W max.

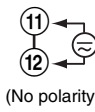
● Terminal Details

100 to 240 VAC	24 VAC/DC
	

Options

● Model Numbers

The options specification of the E5CD is given in the following location in the model number.

E5CD-□□ □ □ □ M-□□□
└── Options

Code	Specification
000 or 800	None
001	Event inputs 1 and 2, and CT1
002 or 802	Communications (RS-485) and CT1
004 or 804	Communications (RS-485), and event inputs 3 and 4
006	Event inputs 1 and 2, and transfer output Transfer output: Current: 4 to 20 mA DC Voltage: 1 to 5 VDC

● Terminal Details

Do not connect anything to the terminals that are shaded gray.

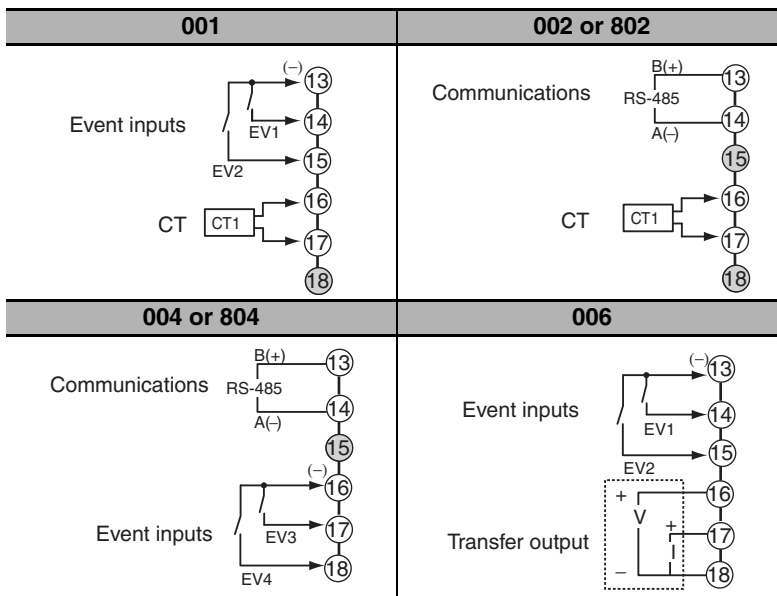

Note: Use non-voltage inputs for the event inputs.
 The polarity for a non-contact input is indicated by “(-).”

2-2-2 E5CD-B Terminal Block Wiring Example

● Terminal Arrangement

The terminals block of the E5CD-B is divided into five types of terminals: control output 1, sensor input, auxiliary outputs, input power supply, and options.

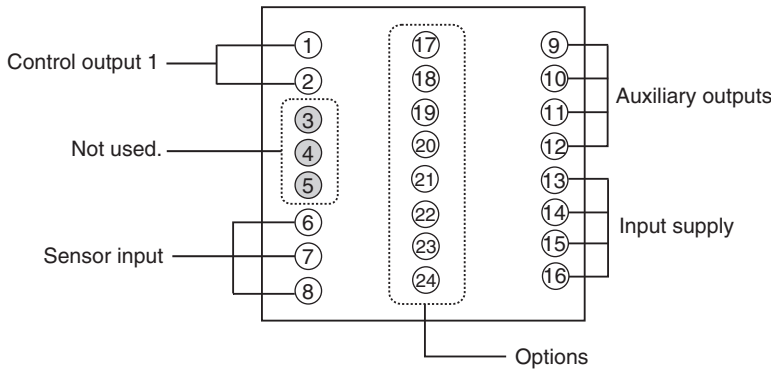

Precautions for Correct Use

When you purchase the Digital Controller, it will be set for a K thermocouple (input type = 5). If a different sensor is used, an input error (*5.ERR*) will occur. Check the setting of the Input Type parameter.

Control Output 1

● Model Numbers

The control output 1 specification of the E5CD-B is given in the following location in the model number.

E5CD-□□□□ B M-□□□□
 Control outputs 1

Code	Output type	Specification
RX	1 relay output	250 VAC, 3 A (resistive load)
QX	1 voltage output (for driving SSR)	12 VDC, 21 mA
CX	1 linear current output	4 to 20 mA DC or 0 to 20 mA DC with load of 500 Ω max.

● Terminal Details

RX	QX	CX

Sensor Input

● Model Numbers

All E5CD-B models have universal sensor inputs, so the code in the model number is always “M.”

E5CD-□□ □ □ B M-□□□□
 └── Sensor input

TC (thermocouple)	Pt (resistance thermometer)	I (current)	V (voltage)



Precautions for Correct Use

- When complying with EMC standards, the line connecting the sensor must be 30 m or less. If the cable length exceeds 30 m, compliance with EMC standards will not be possible.
- The sensor input is not electrically isolated from the internal circuits. If you use a grounded thermocouple, do not connect one of the sensor input terminals to ground. (If the sensor input terminals are connected to ground, errors will occur in the measured temperature as a result of leakage current.)

Auxiliary Outputs

● Model Numbers

The number of auxiliary outputs on the E5CD-B is given in the following location in the model number.

E5CD-□□ □ □ B M-□□□□
 └── No. of auxiliary outputs

Code	Output type	Specification
2	Model with 2 auxiliary outputs	SPST-NO, 250 VAC, 2 A

● Terminal Details

Model with 2 auxiliary outputs

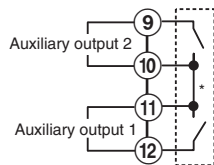

* Common terminals are indicated with asterisks (*).

Input Power Supply

● Model Numbers

The input power supply specification of the E5CD-B is given in the following location in the model number.

E5CD-□□ □ □ B M-□□□□
 └── Input power supply

The codes that are given in the following table show the specification.

Code	Specification	Specification
A	100 to 240 VAC, 50/60 Hz	Option number 000: 5.2 VA max. Other option numbers: 6.5 VA max.
D	24 VAC, 50/60 Hz 24 VDC (no polarity)	Option number 000: 3.1 VA max./1.6 W max. Other option numbers: 4.1 VA max./2.3 W max.

● Terminal Details

Details on the input power supply terminals are shown below.

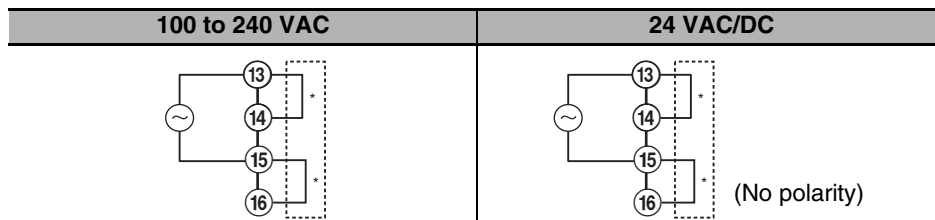

- * Common terminals are indicated with asterisks (*). You can use them for crossover wiring. For crossover wiring, do not exceed the maximum number of Temperature Controllers given below.
- 100 to 240 VAC Controllers: 16 max.
 - 24 VAC/VDC Controllers: 8 max.

Options

● Model Numbers

The options specification of the E5CD-B is given in the following location in the model number.

E5CD-□□ □ □ B M-□□□□
 └── Options

Code	Specification
000 or 800	None
001	Event inputs 1 and 2, and CT1
002 or 802	Communications (RS-485) and CT1
004 or 804	Communications (RS-485), and event inputs 3 and 4
006	Event inputs 1 and 2, and transfer output Transfer output: Current: 4 to 20 mA DC Voltage: 1 to 5 VDC

● Terminal Details

Do not connect anything to the terminals that are shaded gray.

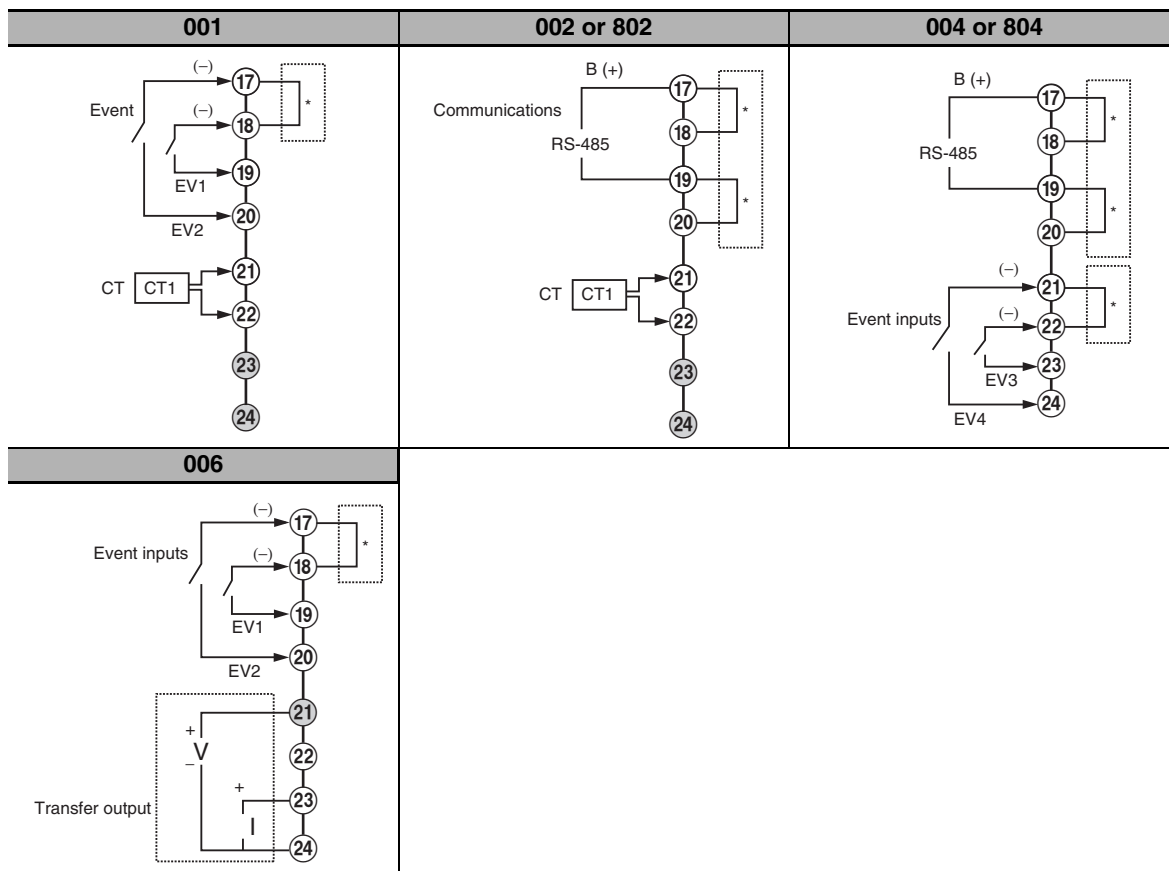

* Common terminals are indicated with asterisks (*).
 You can use communications common terminals for crossover wiring.
 Note: Use non-voltage inputs for the event inputs.
 The polarity for a non-contact input is indicated by "(-)."

2-2-3 E5ED Terminal Block Wiring Example

● Terminal Arrangement

The terminals block of the E5ED is divided into five types of terminals: control outputs 1 and 2, sensor input, auxiliary outputs, input power supply, and options.

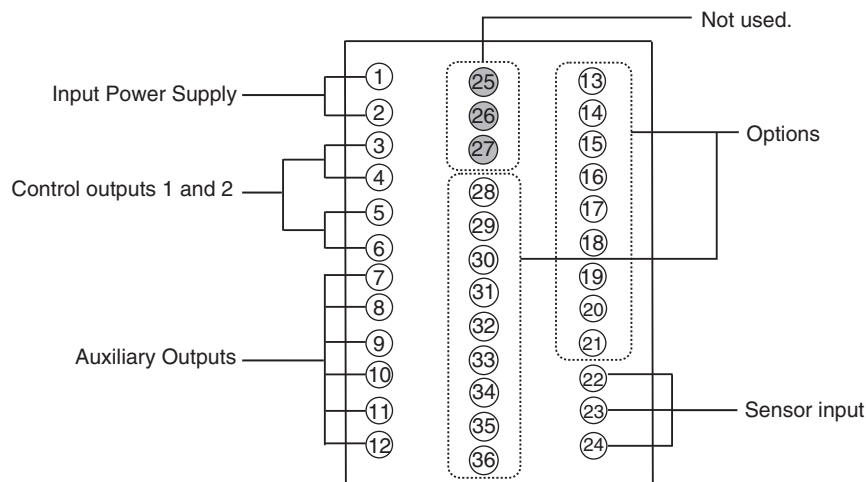

Precautions for Correct Use

When you purchase the Digital Controller, it will be set for a K thermocouple (input type = 5). If a different sensor is used, an input error (*5.ERR*) will occur. Check the setting of the Input Type parameter.

Control Outputs 1 and 2

● Model Numbers

The control outputs 1 and 2 specifications of the E5ED are given in the following location in the model number.

E5ED-□□ □ □ □ M-□□□□

Control outputs 1 and 2

Code	Output type	Specification
RX	1 relay output	250 VAC, 5 A (resistive load)
QX	1 voltage output (for driving SSR)	12 VDC, 40 mA
CX	1 linear current output	4 to 20 mA DC or 0 to 20 mA DC with load of 500 Ω max.
QR	1 voltage output (for driving SSR) and 1 relay output	12 VDC, 21 mA for voltage output 250 VAC, 5 A (resistive load) for relay output
RR	2 relay outputs	250 VAC, 5 A (resistive load)

● **Terminal Details**

Do not connect anything to the terminals that are shaded gray.

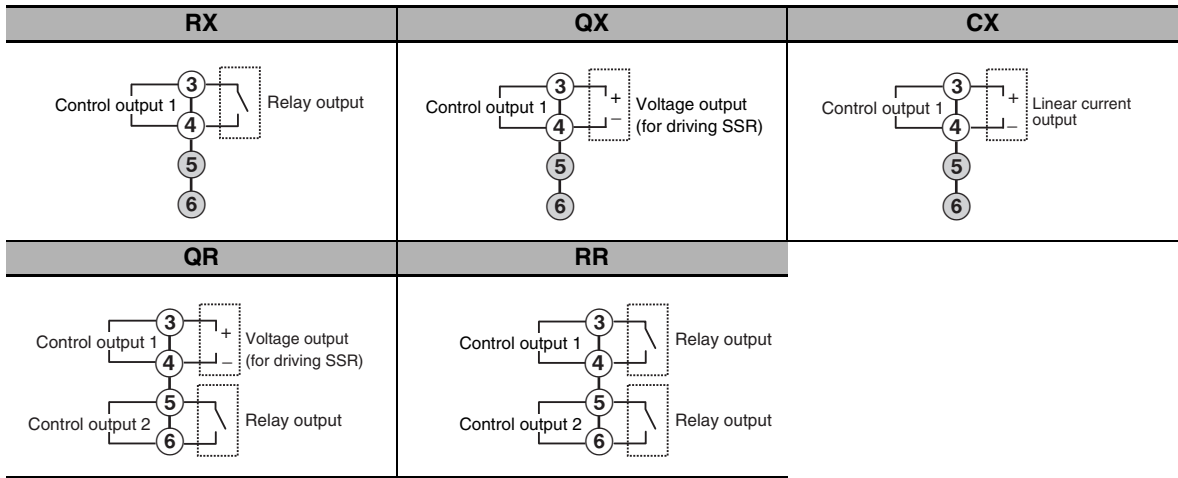

Sensor Input

● **Model Numbers**

All E5ED models have universal sensor inputs, so the code in the model number is always "M."



● **Terminal Details**

Do not connect anything to the terminals that are shaded gray.

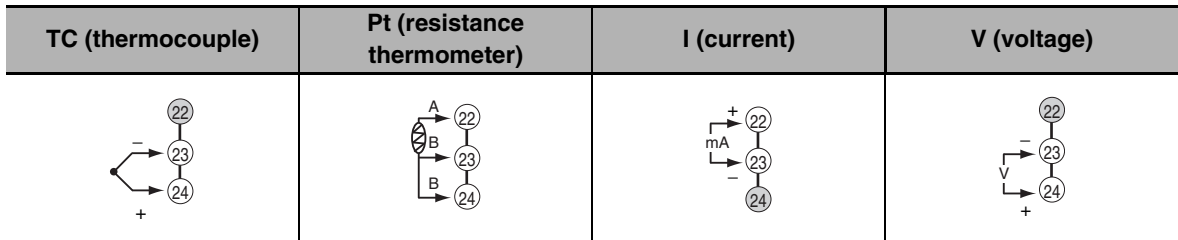

Precautions for Correct Use

- When complying with EMC standards, the line connecting the sensor must be 30 m or less. If the cable length exceeds 30 m, compliance with EMC standards will not be possible.
- The sensor input is not electrically isolated from the internal circuits. If you use a grounded thermocouple, do not connect one of the sensor input terminals to ground. (If the sensor input terminals are connected to ground, errors will occur in the measured temperature as a result of leakage current.)

Auxiliary Outputs

● Model Numbers

The number of auxiliary outputs on the E5ED is given in the following location in the model number.

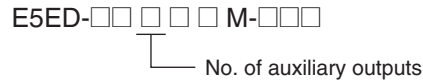

Code	Auxiliary outputs	Specification
2	Model with 2 auxiliary outputs	SPST-NO, 250 VAC, 3 A
4	Model with 4 auxiliary outputs	SPST-NO, 250 VAC, 2 A

● Terminal Details

Do not connect anything to the terminals that are shaded gray.

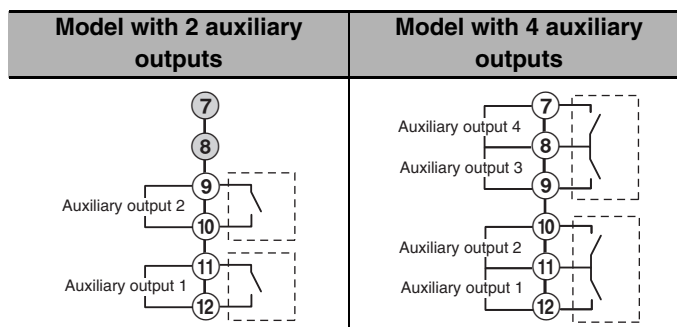

Input Power Supply

● Model Numbers

The input power supply specification of the E5ED is given in the following location in the model number.

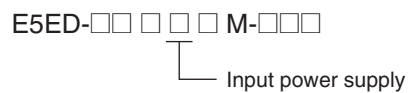

Code	Specification	Power consumption	
		Options No.: 000 or 800	Other option numbers
A	100 to 240 VAC (50/60 Hz)	6.6 VA max.	8.3 VA max.
D	24 VAC, 50/60 Hz	4.1 VA max.	5.5 VA max.
	24 VDC (no polarity)	2.3 W max.	3.2 W max.

● Terminal Details

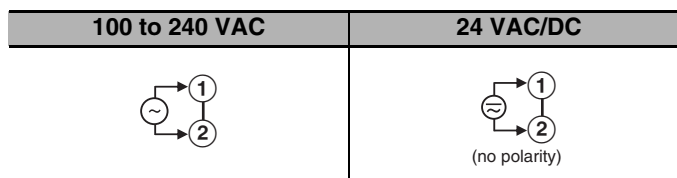

Options

● Model Numbers

The options specification of the E5ED is given in the following location in the model number.

E5ED-□□ □ □ □ M-□□□
└─ Options

Code	Specification
000 or 800	None
004 or 804	Communications (RS-485), and event inputs 1 and 2
008 or 808	Communications (RS-485), event inputs 1 and 2, and CT1
010	Event inputs 1 to 4, and CT1
022	Communications (RS-485), and event inputs 1, 2, 5 and 6, and transfer output

● Terminal Details

Do not connect anything to the terminals that are shaded gray.

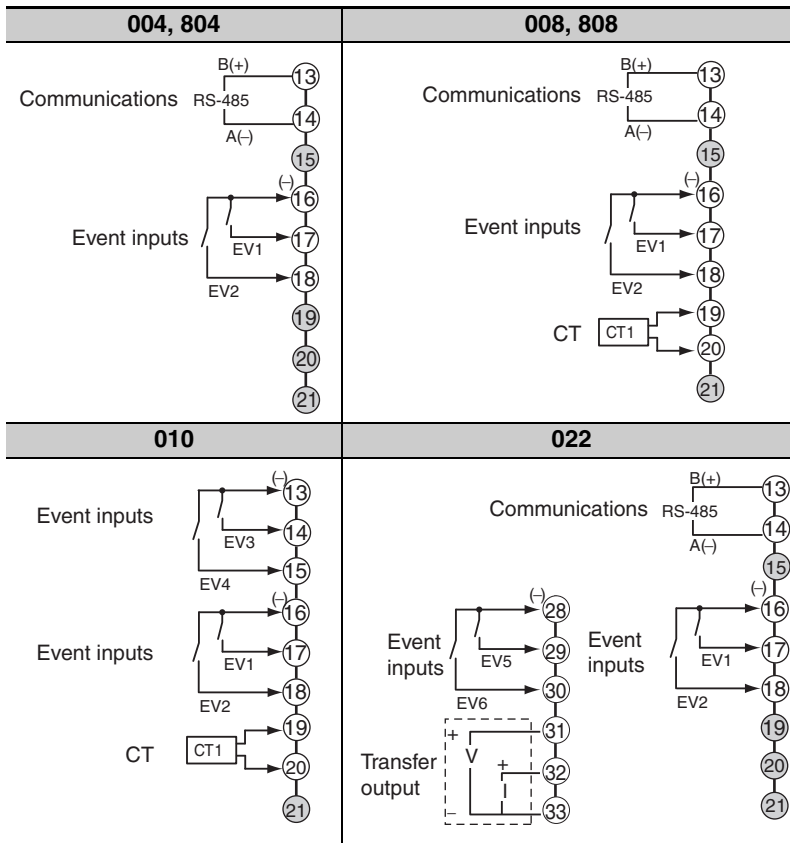

Note: Use non-voltage inputs for the event inputs.
 The polarity for a non-contact input is indicated by “(-).”

2-2-4 E5ED-B Terminal Block Wiring Example

● Terminal Arrangement

The terminals block of the E5ED-B is divided into five types of terminals: control outputs 1 and 2, sensor input, auxiliary outputs, input power supply, and options.

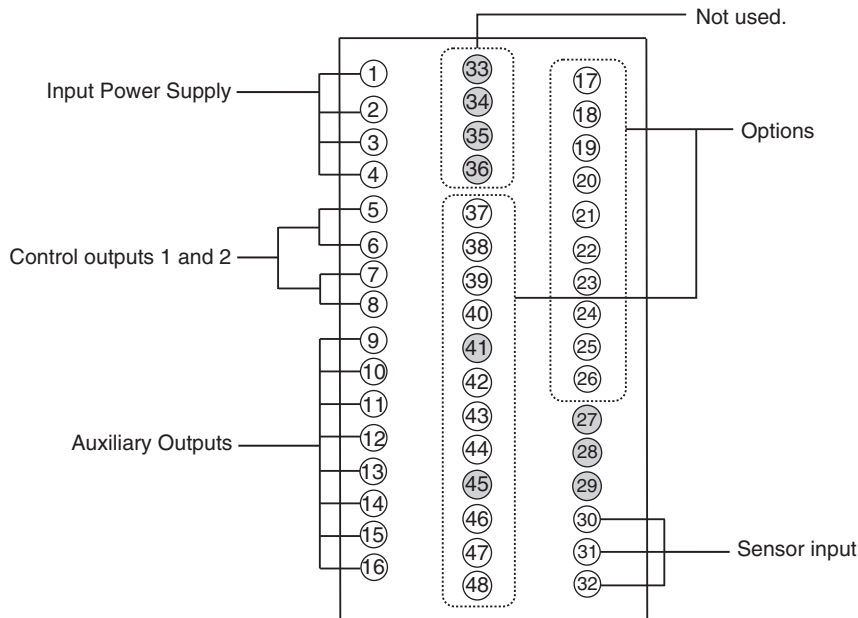

Note: The terminals that are shaded gray are not used.



Precautions for Correct Use

When you purchase the Digital Controller, it will be set for a K thermocouple (input type = 5). If a different sensor is used, an input error (*5.ERR*) will occur. Check the setting of the Input Type parameter.

Control Outputs 1 and 2

● Model Numbers

The control outputs 1 and 2 specifications of the E5ED-B are given in the following location in the model number.

E5□D-□□ □ □ B M-□□□□

Control outputs 1 and 2

Code	Output type	Specification
RX	1 relay output	250 VAC, 5 A (resistive load)
QX	1 voltage output (for driving SSR)	12 VDC, 40 mA
CX	1 linear current output	4 to 20 mA DC or 0 to 20 mA DC with load of 500 Ω max.
QR	1 voltage output (for driving SSR) and 1 relay output	12 VDC, 21 mA for voltage output 250 VAC, 5 A (resistive load) for relay output
RR	2 relay outputs	250 VAC, 5 A (resistive load)

● Terminal Details

RX	QX	CX
QR	RR	

Sensor Input

● Model Numbers

All E5ED-B models have universal sensor inputs, so the code in the model number is always “M.”

E5ED-□□ □ □ B M-□□□
└─ Sensor input

● Terminal Details

Do not connect anything to the terminals that are shaded gray.

TC (thermocouple)	Pt (resistance thermometer)	I (current)	V (voltage)



Precautions for Correct Use

- When complying with EMC standards, the line connecting the sensor must be 30 m or less. If the cable length exceeds 30 m, compliance with EMC standards will not be possible.
- The sensor input is not electrically isolated from the internal circuits. If you use a grounded thermocouple, do not connect one of the sensor input terminals to ground. (If the sensor input terminals are connected to ground, errors will occur in the measured temperature as a result of leakage current.)

Auxiliary Outputs

● Model Numbers

The number of auxiliary outputs on the E5ED-B is given in the following location in the model number.

E5ED-□□ □ □ B M-□□□□
 └──────────┬──────────
 No. of auxiliary outputs

Code	Auxiliary outputs	Specification
2	Model with 2 auxiliary outputs	SPST-NO, 250 VAC, 3 A
4	Model with 4 auxiliary outputs	SPST-NO, 250 VAC, 2 A

● Terminal Details

Do not connect anything to the terminals that are shaded gray.

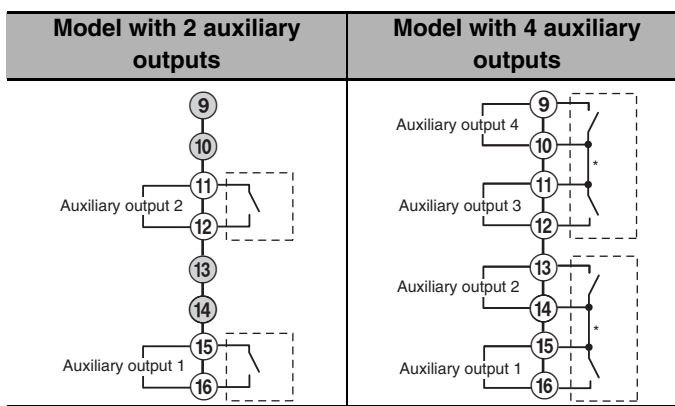

* Common terminals are indicated with asterisks (*).

Input Power Supply

● Model Numbers

The input power supply specification of the E5ED-B is given in the following location in the model number.

E5ED-□□ □ □ B M-□□□□
 └──────────┬──────────
 Input power supply

Code	Specification	Power consumption	
		Options No.: 000	Other option numbers
A	100 to 240 VAC, 50/60 Hz	6.6 VA max.	8.3 VA max.
D	24 VAC, 50/60 Hz	4.1 VA max.	5.5 VA max.
	24 VDC (no polarity)	2.3 W max.	3.2 W max.

● Terminal Details

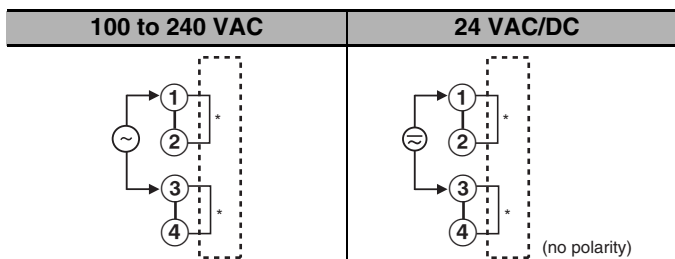

* Common terminals are indicated with asterisks (*). You can use them for crossover wiring. For crossover wiring, do not exceed the maximum number of Digital Controllers given below.
 100 to 240 VAC Controllers: 16 max.
 24 VAC/VDC Controllers: 8 max.

Options

● Model Numbers

The options specification of the E5ED-B is given in the following location in the model number.

E5ED-□□ □ □ B M-□□□
└── Options

Code	Specification
000 or 800	None
004 or 804	Communications (RS-485), event inputs 1 and 2
008 or 808	Communications (RS-485), event inputs 1 and 2, and CT1
010	Event inputs 1, 2, 3, and 4, and CT1
022	Communications (RS-485), event inputs 1, 2, 3, 4, 5, and 6, transfer output

● Terminal Details

Do not connect anything to the terminals that are shaded gray.

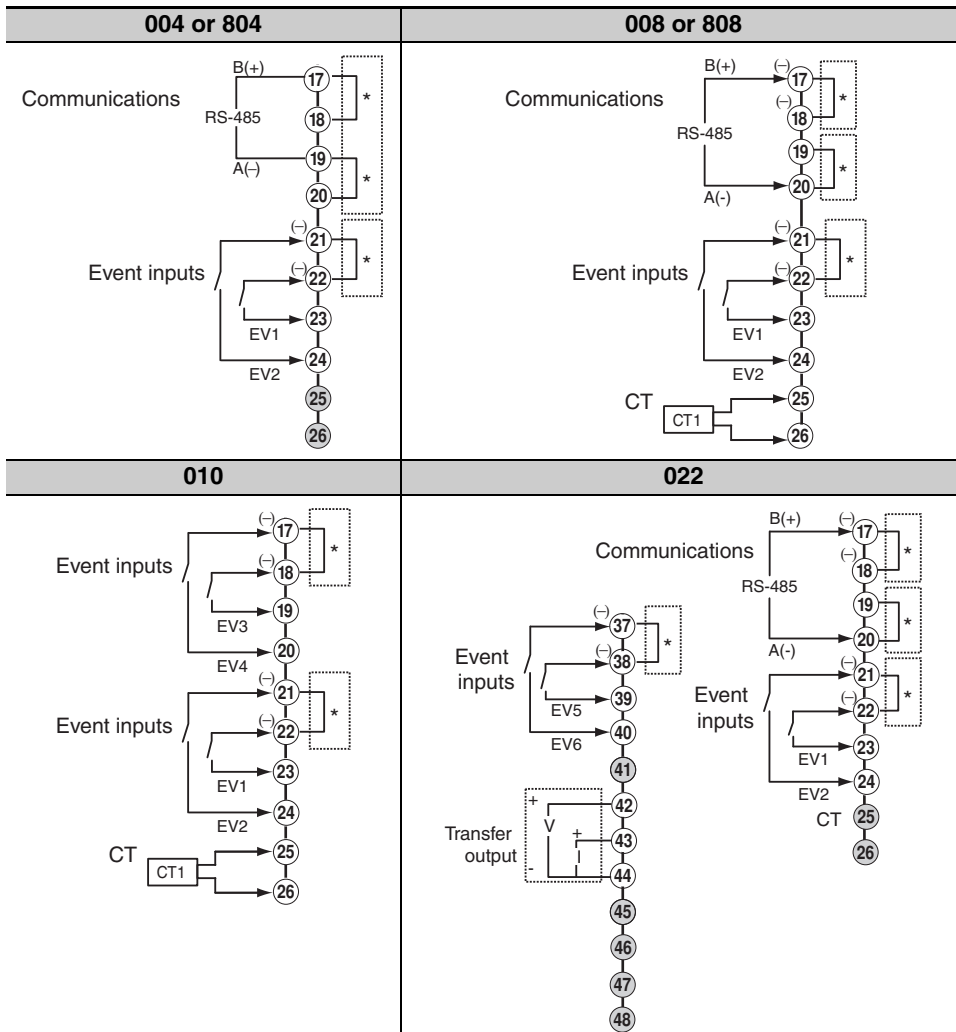

* Common terminals are indicated with asterisks (*).

You can use communications common terminals for crossover wiring.

Note: Use non-voltage inputs for the event inputs.

The polarity for a non-contact input is indicated by “(-).”

2-2-5 Precautions when Wiring

- Separate input leads and power lines in order to prevent external noise.
- Use crimp terminals when wiring the screw terminals.
- Use the suitable wiring material and crimp tools for crimp terminals.
- Tighten the terminal screws to a torque of 0.43 to 0.58 N·m.

● E5CD or E5ED (models with screw terminal blocks)

Wires

Use the wire specifications given in the following table.

Model	Recommended wires	Stripping length
E5CD or E5ED	AWG24 to AWG18 (0.205 to 0.823 mm ²)	6 to 8 mm (when crimp terminals are not used)

- Strip the wires on which crimp terminals will be used to the length recommended by the crimp terminal manufacturer.
- Use shielded twisted-pair cables for signal lines to prevent the influence of noise.

Crimp Terminals

For the E5CD or E5ED, use the following types of crimp terminals for M3 screws.

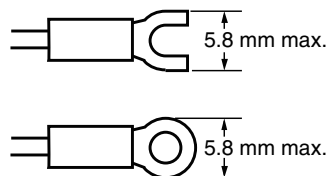

Although you can connect two crimp terminals with insulation sleeves to one terminal, you cannot do so if the diameter of the insulation sleeves is too large.

Select a crimp terminal that can be tightened as shown below.

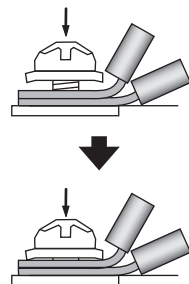

Some terminal blocks have a large crimp part. In this case, bend the terminal in advance as shown in the figure, and tighten slowly to ensure that the terminal screw is vertical to the terminal surface of the terminal block.

● E5□D-B (Models with Push-In Plus Terminal Blocks)

1. Connecting to the Push-In Plus Terminal Block

- Part Names of the Terminal Block

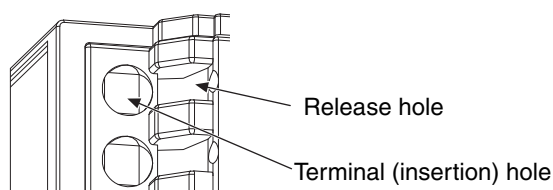

- Connecting Wires with Ferrules or Solid Wires

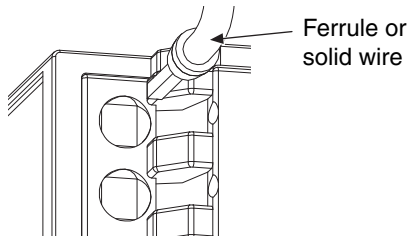

If a wire is difficult to connect because it is too thin, use a flat-blade screwdriver in the same way as when connecting stranded wire.

- Connecting Stranded Wires

Use the following procedure to connect the wires to the terminal block.

- (1) Hold a flat-blade screwdriver at an angle and insert it into the release hole. The angle should be between 10° and 15° . If the flat-blade screwdriver is inserted correctly, you will feel the spring in the release hole.
- (2) With the flat-blade screwdriver still inserted into the release hole, insert the wire into the terminal hole until it strikes the terminal block.
- (3) Remove the flat-blade screwdriver from the release hole.

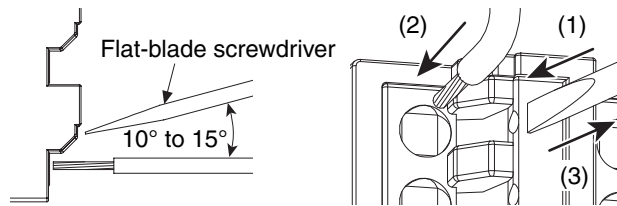

- Checking Connections

- After the insertion, pull gently on the wire to make sure that it will not come off and the wire is securely fastened to the terminal block.
- To prevent short circuits, insert the stripped part of a stranded or solid wire or the conductive part of a ferrule until it is hidden inside the terminal insertion hole. (See the following diagram.)

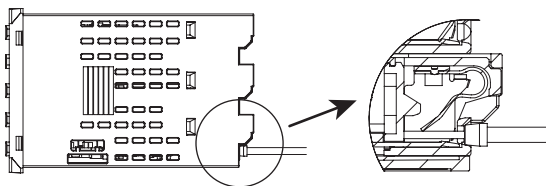

2. Removing Wires from the Push-In Plus Terminal Blocks

Use the following procedure to remove wires from the terminal block.

The same method is used to remove stranded wires, solid wires, and ferrules.

- (1) Hold a flat-blade screwdriver at an angle and insert it into the release hole.
- (2) With the screwdriver still inserted into the release hole, remove the wire from the terminal insertion hole.
- (3) Remove the flat-blade screwdriver from the release hole.

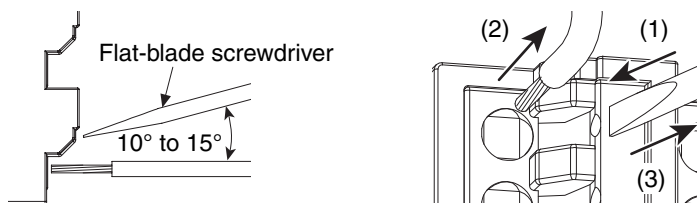

3. Recommended Wires, Ferrules and Crimp Tools

- Recommended Wires (stranded or solid wires)

Recommended wires	Stripping length (ferrules not used)
AWG24 to AWG16 (0.25 to 1.5 mm ²)	8 mm

- Recommended Ferrules

Applicable wire		Ferrule conductor length (mm)	Stripping length (mm) (ferrules used)	Recommended ferrules		
(mm ²)	(AWG)			Manufactured by Phoenix Contact	Manufactured by Weidmuller	Manufactured by Wago
0.25	24	8	10	AI0,25-8	H0.25/12	FE-0.25-8N-YE
		10	12	AI0,25-10	---	---
0.34	22	8	10	AI0,34-8	H0.34/12	FE-0.34-8N-TQ
		10	12	AI0,34-10	---	---
0.5	20	8	10	AI0,5-8	H0.5/14	FE-0.5-8N-WH
		10	12	AI0,5-10	H0.5/16	FE-0.5-10N-WH
0.75	18	8	10	AI0,75-8	H0.75/14	FE-0.75-8N-GY
		10	12	AI0,75-10	H0.75/16	FE-0.75-10N-GY
1 or 1.25	18 or 17	8	10	AI1-8	H1.0/14	FE-1.0-8N-RD
		10	12	AI1-10	H1.0/16	FE-1.0-10N-RD
1.25 or 1.5	17 or 16	8	10	AI1,5-8	H1.5/14	FE-1.5-8N-BK
		10	12	AI1,5-10	H1.5/16	FE-1.5-10N-BK
Recommended crimp tool				CRIMPFOX6 CRIMPFOX6T-F CRIMPFOX10S	PZ6 roto	Variocrimp4

Note1: Make sure that the outer diameter of the wire coating is smaller than the inner diameter of the insulation sleeve of the recommended ferrule.

- 2: Make sure that the ferrule processing dimensions conform to the following figures.

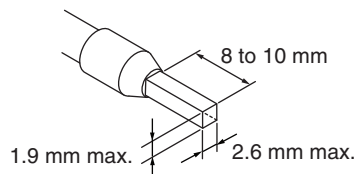

- Recommended Flat-blade Screwdriver

Use a flat-blade screwdriver to connect and remove wires.

Use the following flat-blade screwdriver.

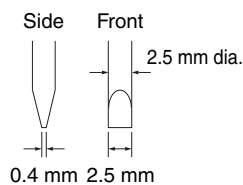

Model	Manufacturer
ESD 0,40 × 2,5	Wera
SZS 0,4 × 2,5 SZF 0-0,4 × 2,5 *	Phoenix Contact
0.4 × 2.5 × 75 302	Wiha
AEF.2,5 × 75	Facom
210-719	Wago
SDI 0.4 × 2.5 × 75	Weidmuller

* You can purchase the SZF 0-0,4 × 2,5 flat-blade screwdriver made by PHOENIX CONTACT with OMRON model XW4Z-00B.

2-2-6 Wiring

In the connection diagrams, the left side of the terminal numbers represents the inside of the Digital Controller and the right side represents the outside.

● Power Supply

Power Consumption

Input Power Supply	E5CD or E5CD-B		E5ED or E5ED-B	
	Options No.: 000 or 800	Options No.: Not 000 or 800	Options No.: 000 or 800	Options No.: Not 000 or 800
100 to 240 VAC, 50/60 Hz	5.2 VA max.	6.5 VA max.	6.6 VA max.	8.3 VA max.
24 VAC, 50/60 Hz	3.1 VA max.	4.1 VA max.	4.1 VA max.	5.5 VA max.
24 VDC (no polarity)	1.6 W max.	2.3 W max.	2.3 W max.	3.2 W max.

- These models have reinforced insulation between the input power supply, the relay outputs, and other terminals.

● Inputs

Refer to *2-2-1 E5CD Terminal Block Wiring Example*, *2-2-2 E5CD-B Terminal Block Wiring Example*, *2-2-3 E5ED Terminal Block Wiring Example* or *2-2-4 E5ED-B Terminal Block Wiring Example* for the terminal arrangement.

When extending the thermocouple lead wires, be sure to use compensating wires that match the thermocouple type. When extending the lead wires of a resistance thermometer, be sure to use wires that have low resistance and keep the resistance of the three lead wires the same.

● Control Outputs 1 and 2

The following diagrams show the applicable outputs and their internal equivalent circuits.

E5CD

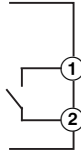
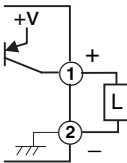
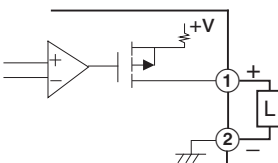
RX (relay output)	QX (voltage output (for driving SSR))	CX (linear current output)
		

Output type		Specification
RX	Relay output	SPST-NO, 250 VAC, 3 A (resistive load), Electrical life: 100,000 operations
QX	Voltage output (for driving SSR)	PNP, 12 VDC $\pm 20\%$, 21 mA (with short-circuit protection)
CX	Linear current output	4 to 20 mA DC or 0 to 20 mA DC with load of 500 Ω max., Resolution: 10,000

E5CD-B

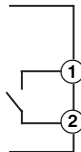
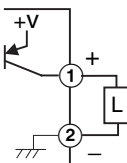
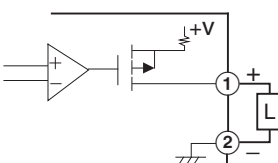
RX (relay output)	QX (voltage output (for driving SSR))	CX (linear current output)
		

Output type		Specification
RX	Relay output	SPST-NO, 250 VAC, 3 A (resistive load), Electrical life: 100,000 operations
QX	Voltage output (for driving SSR)	PNP, 12 VDC $\pm 20\%$, 21 mA (with short-circuit protection)
CX	Linear current output	4 to 20 mA DC or 0 to 20 mA DC with load of 500 Ω max., Resolution: 10,000

E5ED

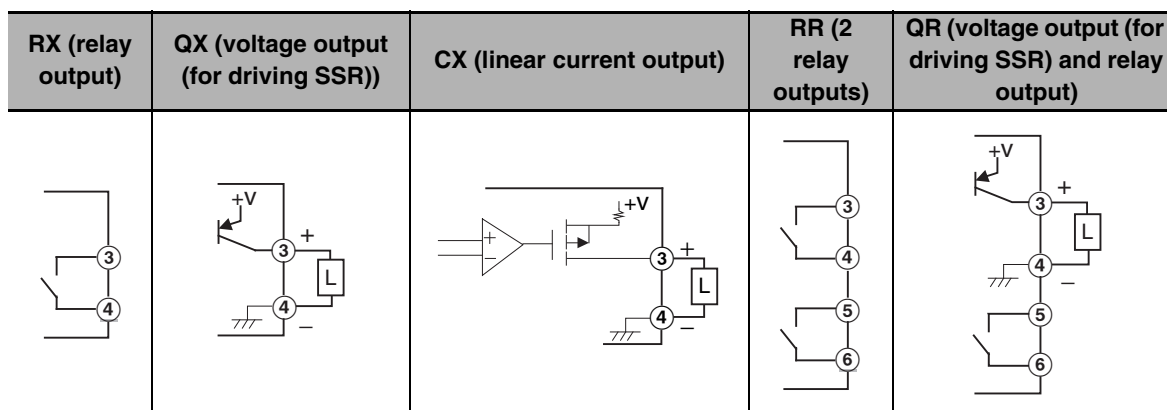

Output type		Specification
RX	Relay output	SPST-NO, 250 VAC, 5 A (resistive load), Electrical life: 100,000 operations
QX	Voltage output (for driving SSR)	PNP, 12 VDC \pm 20%, 40 mA (with short-circuit protection)
CX	Linear current output	4 to 20 mA DC or 0 to 20 mA DC with load of 500 Ω max., Resolution: 10,000
RR	2 relay outputs	SPST-NO, 250 VAC, 5 A (resistive load), Electrical life: 100,000 operations
QR	Voltage output (for driving SSRs) (control output 1)	PNP, 12 VDC \pm 20%, 21 mA (with short-circuit protection)
	Relay output (control output 2)	SPST-NO, 250 VAC, 5 A (resistive load), Electrical life: 100,000 operations

E5ED-B

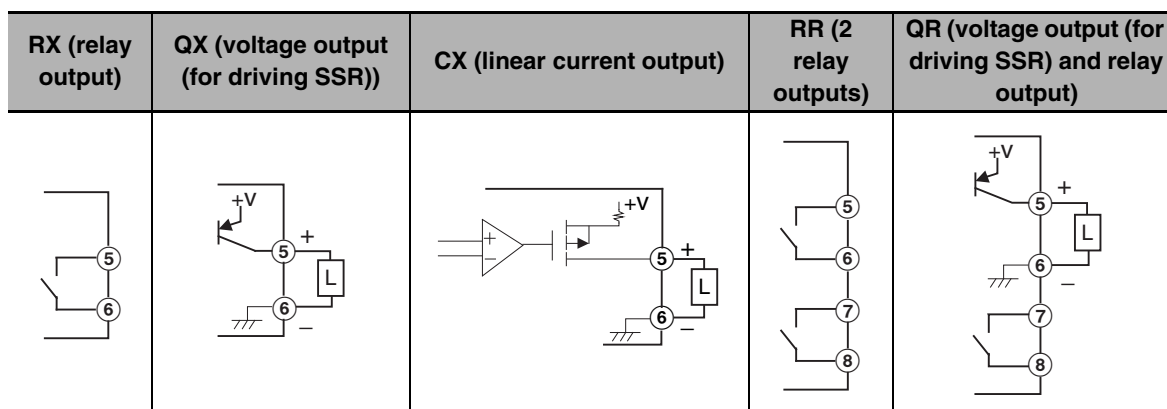

Output type		Specification
RX	Relay output	SPST-NO, 250 VAC, 5 A (resistive load), Electrical life: 100,000 operations
QX	Voltage output (for driving SSR)	PNP, 12 VDC \pm 20%, 40 mA (with short-circuit protection)
CX	Linear current output	4 to 20 mA DC or 0 to 20 mA DC with load of 500 Ω max., Resolution: 10,000
RR	2 relay outputs	SPST-NO, 250 VAC, 5 A (resistive load), Electrical life: 100,000 operations
QR	Voltage output (for driving SSRs) (control output 1)	PNP, 12 VDC \pm 20%, 21 mA (with short-circuit protection)
	Relay output (control output 2)	SPST-NO, 250 VAC, 5 A (resistive load), Electrical life: 100,000 operations

● **Auxiliary Outputs 1 to 4**

- When heating/cooling control is selected for the E5CD or E5CD-B, auxiliary output 2 is assigned as the control output for cooling.
- If heating/cooling control is selected for the E5ED or E5ED-B when there is only one control output, the auxiliary output 4 terminal is assigned as the control output for cooling. (However, if the Digital Controller has two auxiliary outputs, auxiliary output 2 is the cooling control output.)

● **Event Inputs**

Models with an option number of 001, 004, 006, 008, 010, 022, 804 or 808 have one or more event inputs.

E5CD

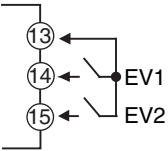
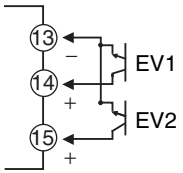
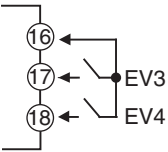
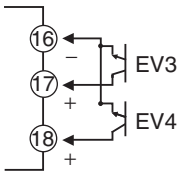
Contact inputs	Non-contact inputs
<p>Option number: 001 or 006</p> 	
<p>Option number: 004 or 804</p> 	

E5CD-B

Contact inputs	Non-contact inputs
<p>Option number: 001 or 006</p>	
<p>Option number: 004 or 804</p>	

E5ED

Contact inputs	Non-contact inputs
<p>Option number: 004, 008 or 808</p>	
<p>Option number: 010</p>	
<p>Option number: 022</p>	

E5ED-B

Contact inputs	Non-contact inputs
<p>Option number: 004, 008, 804</p>	
<p>Option number: 010</p>	
<p>Option number: 022</p>	

- Use non-voltage inputs for the event inputs.
- Use event inputs under the following conditions:
The outflow current is approximately 7 mA.

Contact input ON: 1 kΩ max., OFF: 100 kΩ min.

No-contact input ON: Residual voltage of 1.5 V max.; OFF: Leakage current of 0.1 mA max.

● **CT Inputs**

Models with an option number of 001, 002, 008, 010, 802 or 808 have one or more CT inputs.

● **Transfer Output**

Models with an option number of 006 or 022 have a transfer output.

E5CD

Option number: 006

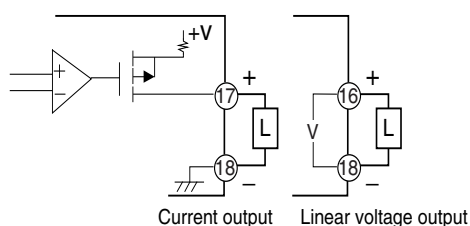

Current output Linear voltage output

E5CD-B

Option number: 006

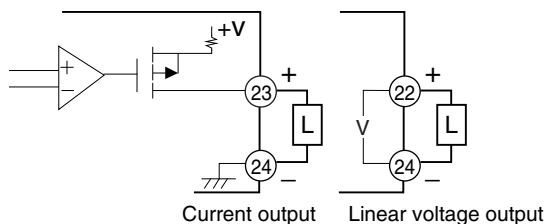

E5ED

Option number: 022

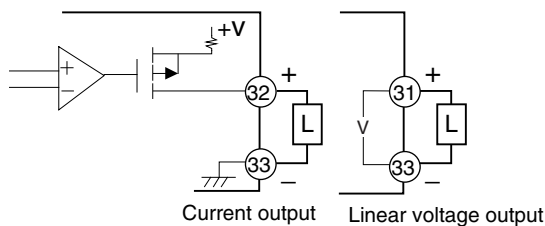

E5ED-B

Option number: 022

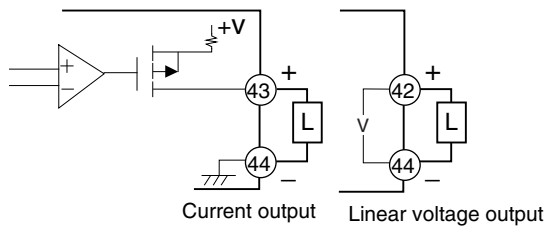

Output type	Specification
Linear current output	4 to 20 mA DC, Load: 500 Ω max., Resolution: 10,000
Linear voltage output	1 to 5 VDC, Load: 1 kΩ min., Resolution: 10,000

● **Communications**

RS-485

Models with an option number of 002, 008, 802 or 808 support RS-485.

To use communications with the E5CD or E5ED, connect the communications cable to terminals 13 and 14, with the E5CD-B or E5ED-B, to terminals 17 or 18 and 19 or 20.

Communications Unit Connection Diagram

E5□D

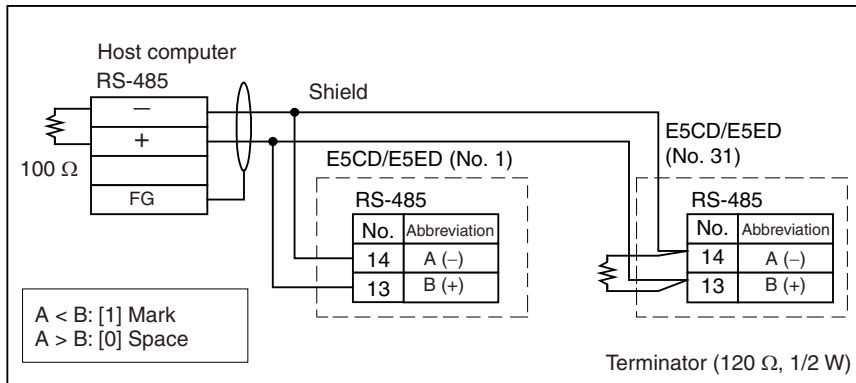

E5□D-B

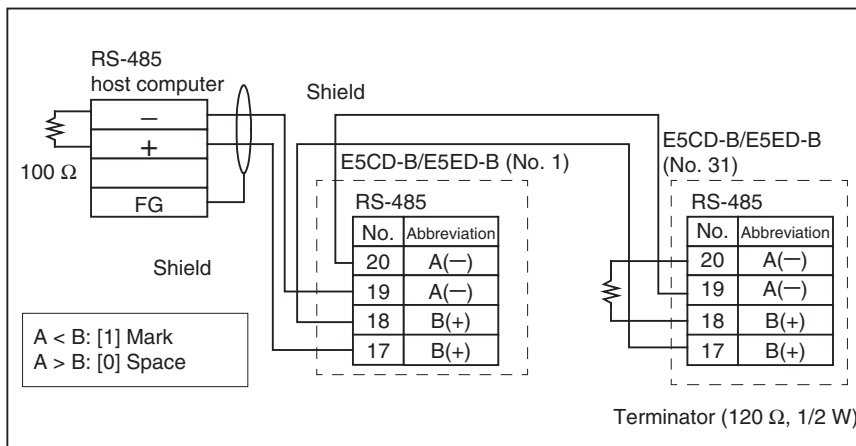

- The RS-485 connection can be either one-to-one or one-to-N. A maximum of 32 Units (including the host computer) can be connected in one-to-N systems. The maximum total cable length is 500 m. Use shielded twisted-pair cable.

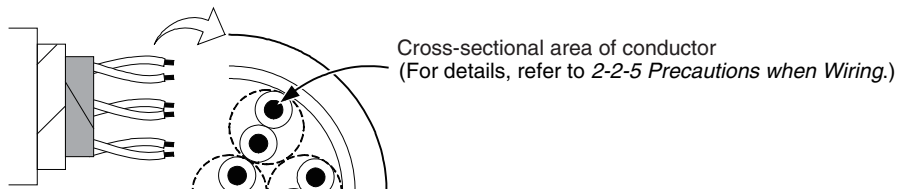

2-3 Installing Temperature Sensors for Packing Machines

A Temperature Sensor for Packing Machines*1 has a diameter of 1.0 mm and it is embedded in a heating plate. It has superior heat resistance and flexibility.

Refer to *5-1 Suppressing Temperature Variations When Using a Temperature Sensor for Packing Machines (for Packing Machines)* for general information.

To measure the temperature close to the seal surface, mount the Sensor as close as possible to the surface.

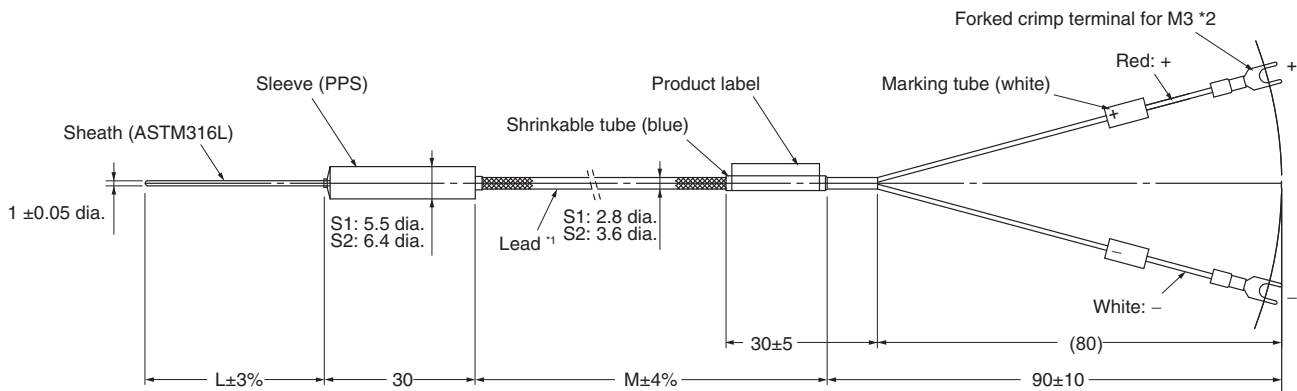

*1 The specifications of E52-series Temperature Sensors for Packing Machines and mounting brackets are provided as an appendix.

*2 Models with ferrules are available.

The following installation methods are assumed.

Example 1: Groove for Temperature Sensor created in heating plate and Temperature Sensor secured with mounting brackets.

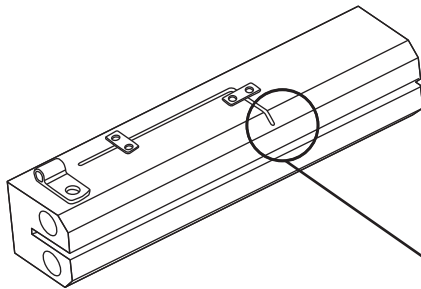

To correctly measure the surface temperature, the following installation conditions are recommended.

Example 2: Groove for Temperature Sensor created in heating plate and Temperature Sensor secured with a cover.

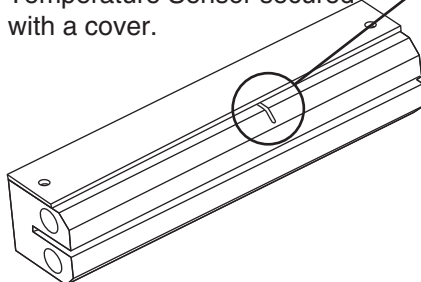

Example 3: Lateral hole for the Temperature Sensor created in the heating plate and the Temperature Sensor inserted into it.

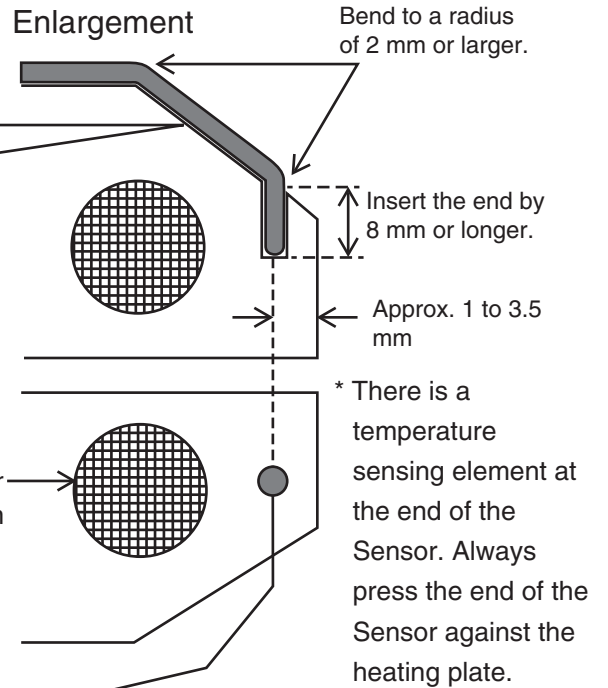
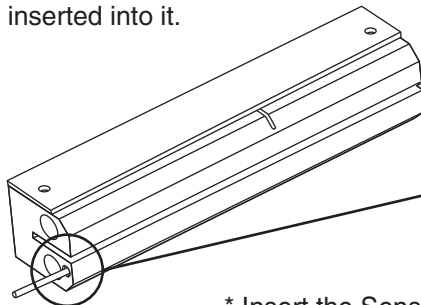

* Insert the Sensor until contact is made with the packing surface.

2-4 Insulation Block Diagrams

The insulation block diagrams are provided in this section.

● E5CD/E5CD-8□□/E5ED-8□□/E5ED-B-8□□

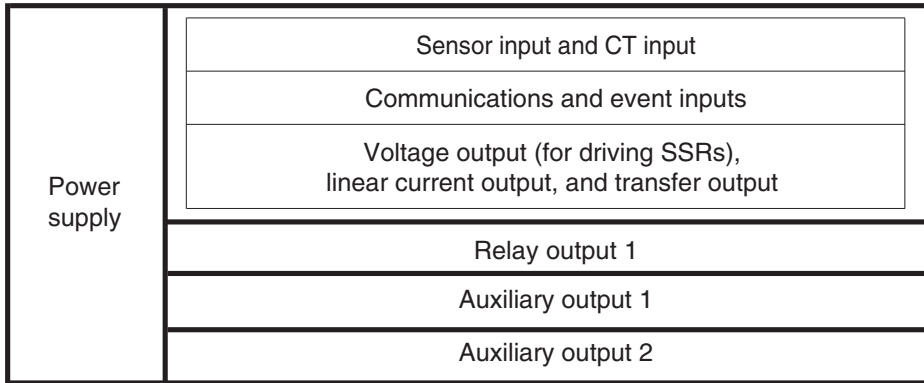

 : Reinforced insulation

 : Functional isolation

● E5CD-B/E5CD-B-8□□

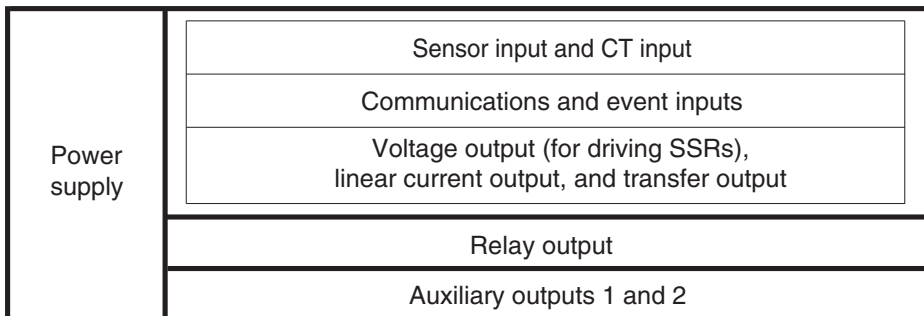

 : Reinforced insulation

 : Functional isolation

● E5ED/E5ED-B

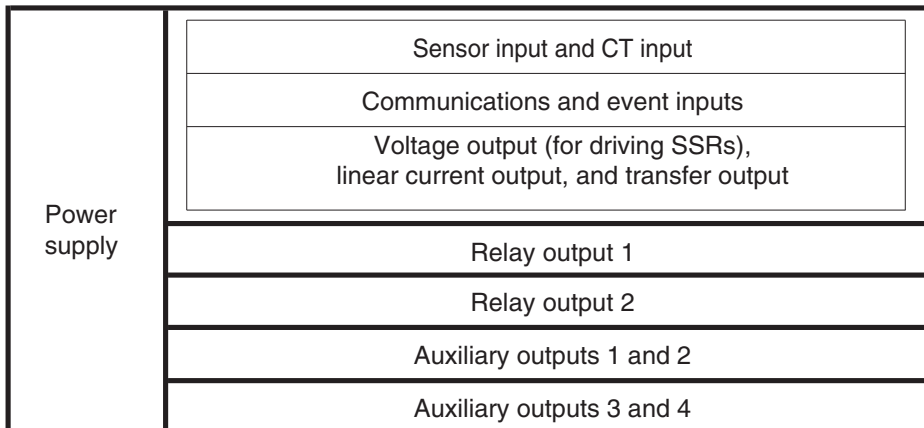

 : Reinforced insulation

 : Functional isolation

2-5 Using the Setup Tool Port **000**

Use one of the Setup Tool ports to connect the computer to the Digital Controller when using the CX-Thermo (EST2-2C-MV4 or later) or other Support Software.

The E58-CIFQ2 USB-Serial Conversion Cable*¹ is required for the connection. For information on the models that can be used with CX-Thermo, contact your OMRON sales representative.

*1 The E58-CIFQ2-E is required to connect to the Setup Tool port on the front panel of the E5ED or E5ED-B.

2-5-1 Procedure

When the USB-Serial Conversion Cable is connected to the Digital Controller, the following operations are possible even if the power supply to the Digital Controller is not turned ON.

- Setting up the Digital Controller from a computer (Special software is required.)
- Changing settings by using key operations on the Digital Controller
- Displaying the current temperature on the Digital Controller

The control outputs, alarm outputs, transfer output, event inputs, and external communications for the Digital Controller will not operate unless the power supply to the Digital Controller is turned ON.

2-5-2 Connection Method

Use the E58-CIFQ2 USB-Serial Conversion Cable to connect the E5□D to the computer. The USB-Serial Conversion Cable is used to communicate with a USB port on a computer as a virtual COM port.

E5CD/E5CD-B

● Setup Tool Port and Connecting Cable

The location of the Setup Tool port on the E5CD or E5CD-B and the required cable are shown below.

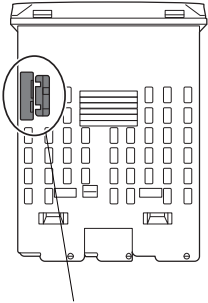
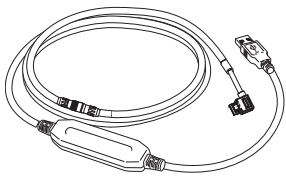
Setup Tool port	Connecting cable
<p>• Top panel on the Digital Controller</p>  <p>Top-panel Setup Tool port</p>	<p>E58-CIFQ2 USB-Serial Conversion Cable</p> 

● **Connection Procedure**

- 1** Connect the serial connector on the USB-Serial Conversion Cable to the Setup Tool port on the top panel of the Digital Controller.

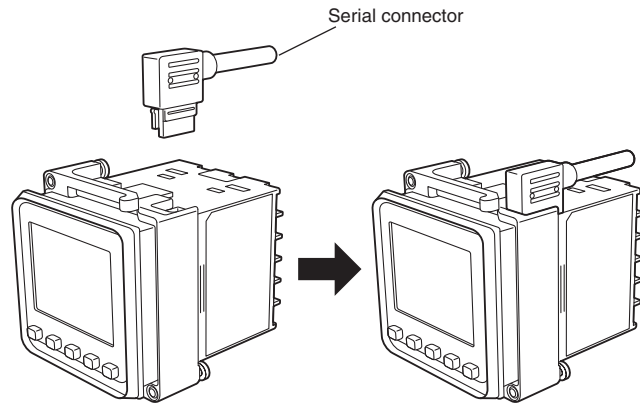

E5ED/E5ED-B

● **Setup Tool Ports and Connecting Cables**

The location of the Setup Tool port on the E5ED or E5ED-B and the required cable are shown below. There are Setup Tool ports on both the top panel and front panel of the Digital Controller.

Setup Tool ports		Connecting cables	
<ul style="list-style-type: none"> • Top panel on the Digital Controller 	<ul style="list-style-type: none"> • Front panel on the Digital Controller 	<p>E58-CIFQ2 USB-Serial Conversion Cable</p>	<p>E58-CIFQ2-E Conversion Cable*</p>

* This Cable is required only to connect to the front-panel Setup Tool port.

● **Connection Procedure**

- Top-panel Port

- 1** Connect the serial connector to the Setup Tool port on the top panel of the Digital Controller.

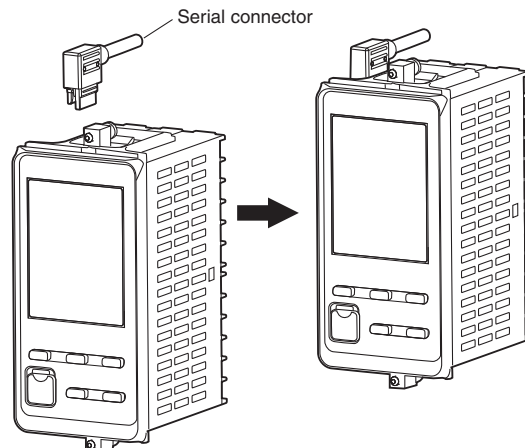

- Front-panel Port

1 Connect the E58-CIFQ2 USB-Serial Conversion Cable to the E58-CIFQ2-E Conversion Cable.

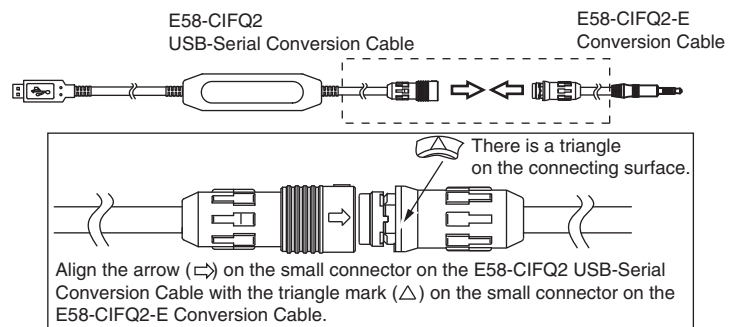

2 Remove the Port Cover from the front-panel Setup Tool port, and then plug in the Conversion Cable.

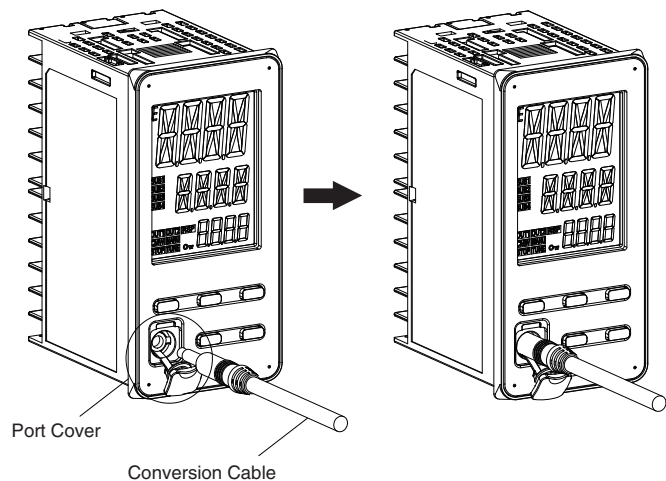

Precautions for Correct Use

- Hold the connector when inserting or disconnecting the Cable.
- When connecting a connector, always make sure that it is oriented correctly. Do not force the connector if it does not connect smoothly. Connectors may be damaged if they are connected with excessive force.
- Do not connect cables to both of the Setup Tool ports at the same time. The Digital Controller may be damaged or may malfunction.

2-5-3 Installing the Driver

1. Connect a USB connector on the computer with a Setup Tool port on the Digital Controller using the Cable or Cables.

2. Obtaining the Driver

When the CX-Thermo Support Software for the Digital Controller is installed, the driver for the USB-Serial Conversion Cable will be copied to the following folder.

C:\Program Files\OMRON\Drivers\USB\E58-CIF

3. Installing the Driver

Install the driver to enable the Cable to be used with the personal computer.

- Installation

When the Cable is connected with the personal computer, the OS will detect the product as a new device. At this time, install the driver using the Installation Wizard.

Note 1: We recommend that you install the driver for each USB port on the computer at the start. The Digital Controller assigns a COM port number to each USB port on the computer. If the same USB port is used, you will be able to use the same COM port number even if you use a different Cable.

2: Installation of the driver will not be completed if the installation is canceled before it is completed. Normal communications will not be possible unless the driver is installed completely. If the driver is not installed completely, uninstall it, and then install it correctly.

4. Setting Setup Tool Communications Conditions

Set the communications port (COM port) number to be used for the CX-Thermo Setup Tool to the COM port number assigned to the USB-Serial Conversion Cable.

Refer to the E58-CIFQ2 USB-Serial Conversion Cable Instruction Manual and Setup Manual for details on how to check the COM port assigned to the USB-Serial Conversion Cable.

The communications conditions for Setup Tool COM ports are fixed as shown in the table below. Set the communications conditions for the CX-Thermo Setup Tool according to the following table

Parameter	Set value
Communications Unit No.	01
Communications baud rate	38.4 (kbps)
Communications data length	7 (bits)
Communications stop bits	2 (bits)
Communications parity	Even

3

Part Names and Basic Procedures

3

3-1	Basic Flow of Operation	3-2
3-2	Power ON	3-3
3-3	Part Names, Part Functions, and Setting Levels	3-4
3-3-1	Part Names and Functions	3-4
3-3-2	Entering Numeric Values	3-7
3-3-3	Setting Levels	3-8
3-4	Procedures after Turning ON the Power Supply	3-11
3-4-1	Basic Flow of Operations	3-11
3-4-2	Basic Procedure	3-11

3-1 Basic Flow of Operation

The following figure shows the basic flow for operating the Digital Controller.

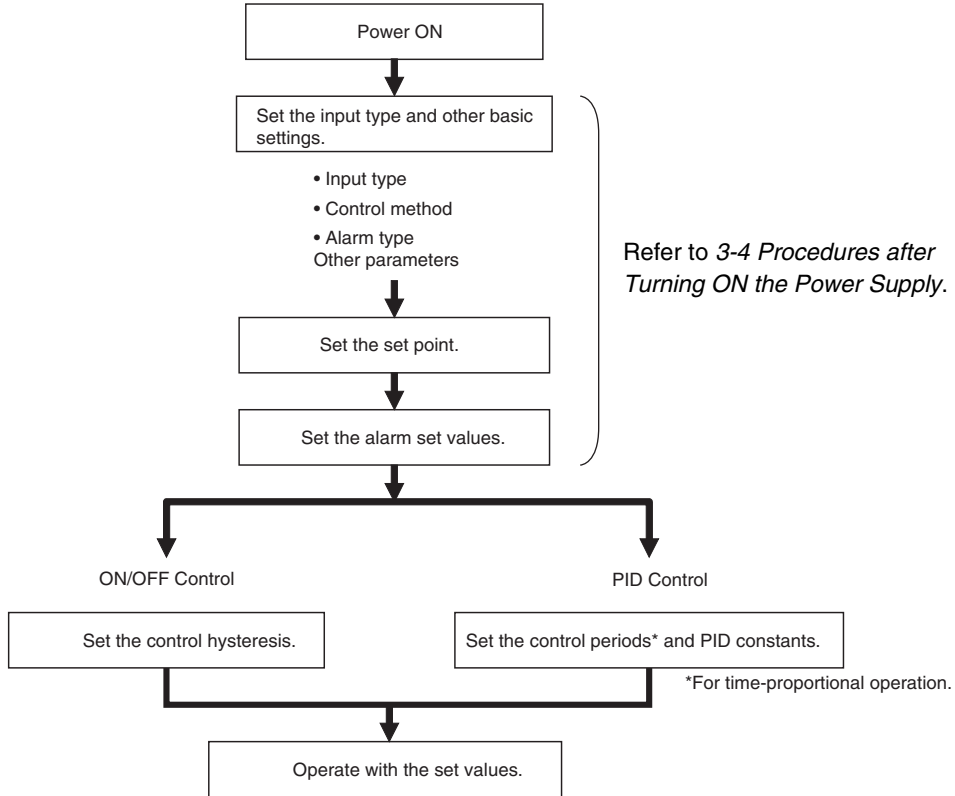

3-2 Power ON

Operation will start as soon as you turn ON the power supply to the E5□D.*

* With the E5□D, you can set the Operation After Power ON parameter to change the operation that is performed when the power supply is turned ON. For details, refer to 5-25 *Setting the Operating Status to Use When Power Is Turned ON*.

The following default settings will be used when operation starts.

- Input type 5: K thermocouple
- PID control operation
- Alarm: Upper-limit alarm*
- Set point: 0°C

* If the Controller is equipped with HB/HS alarm detection, the default setting for the Auxiliary Output 1 Assignment is for heater alarms. Therefore, the alarm 1 function is disabled and the Alarm 1 Type is not displayed. To enable alarm 1, set an output assignment to alarm 1.

After the power comes ON, all indicators and displays will light for approximately 1 second, and then the operation display will appear.

The top display will show the PV and the bottom display will show the SP.

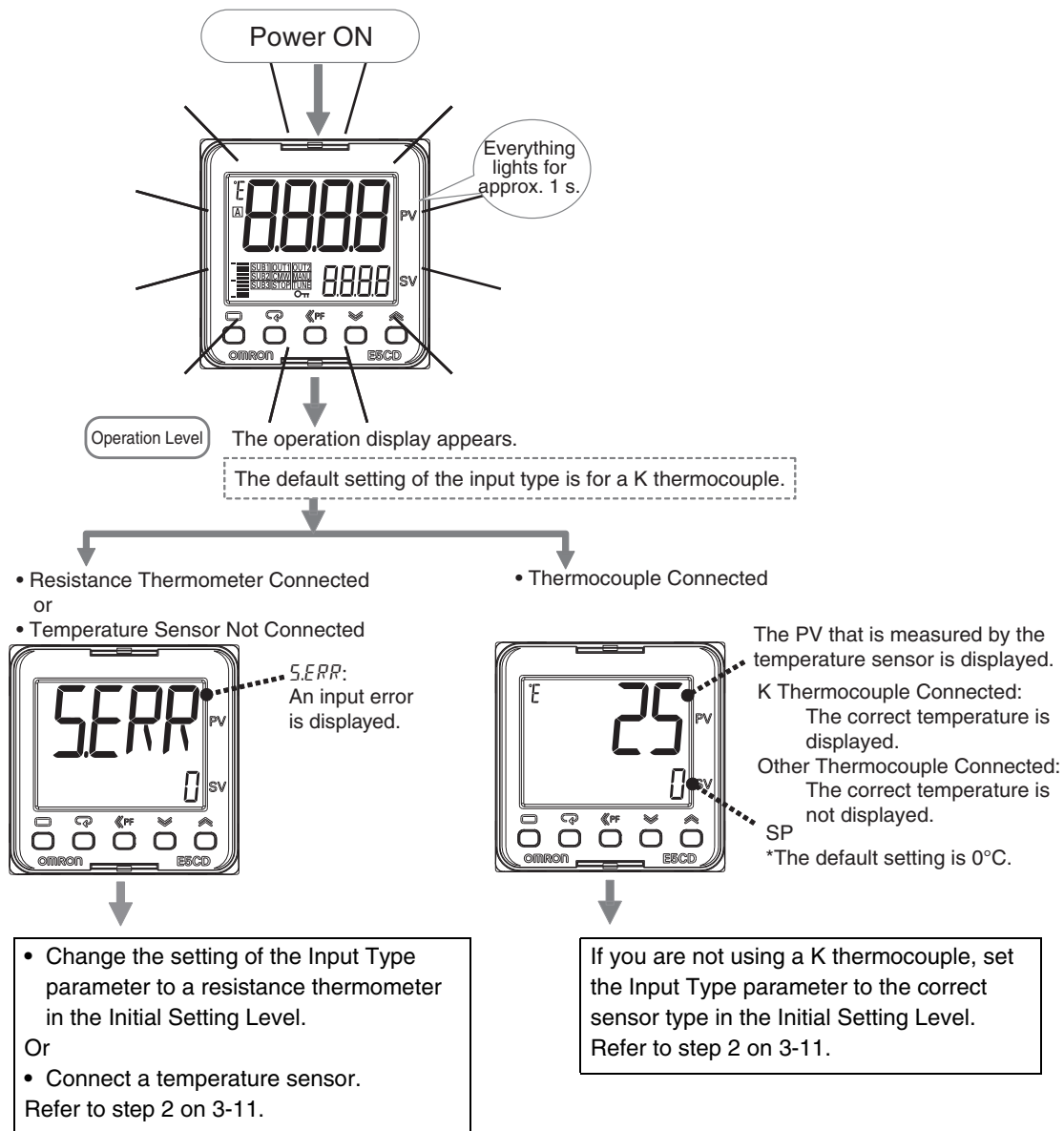

3-3 Part Names, Part Functions, and Setting Levels

3-3-1 Part Names and Functions

E5CD/E5CD-B

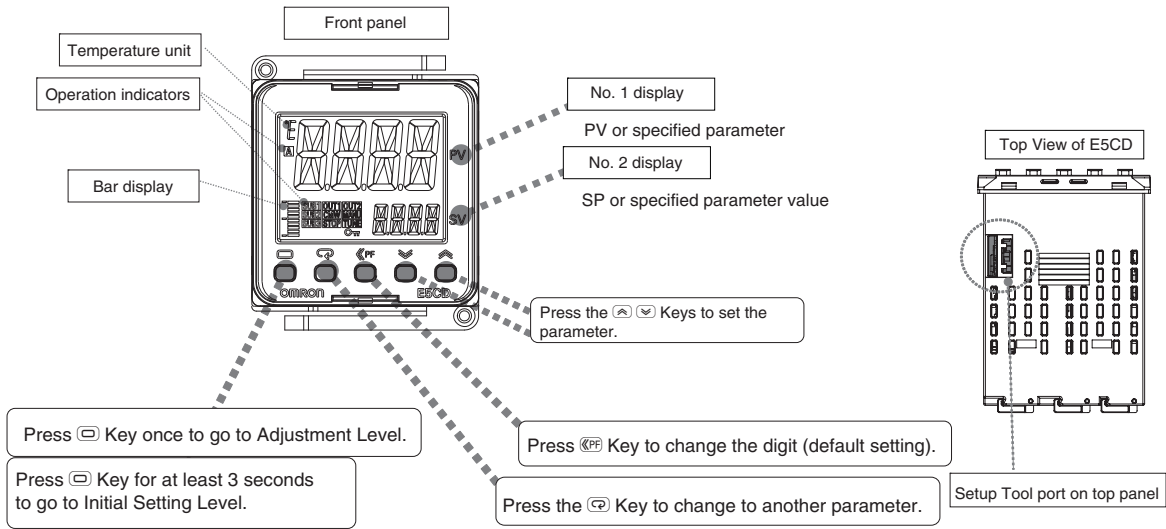



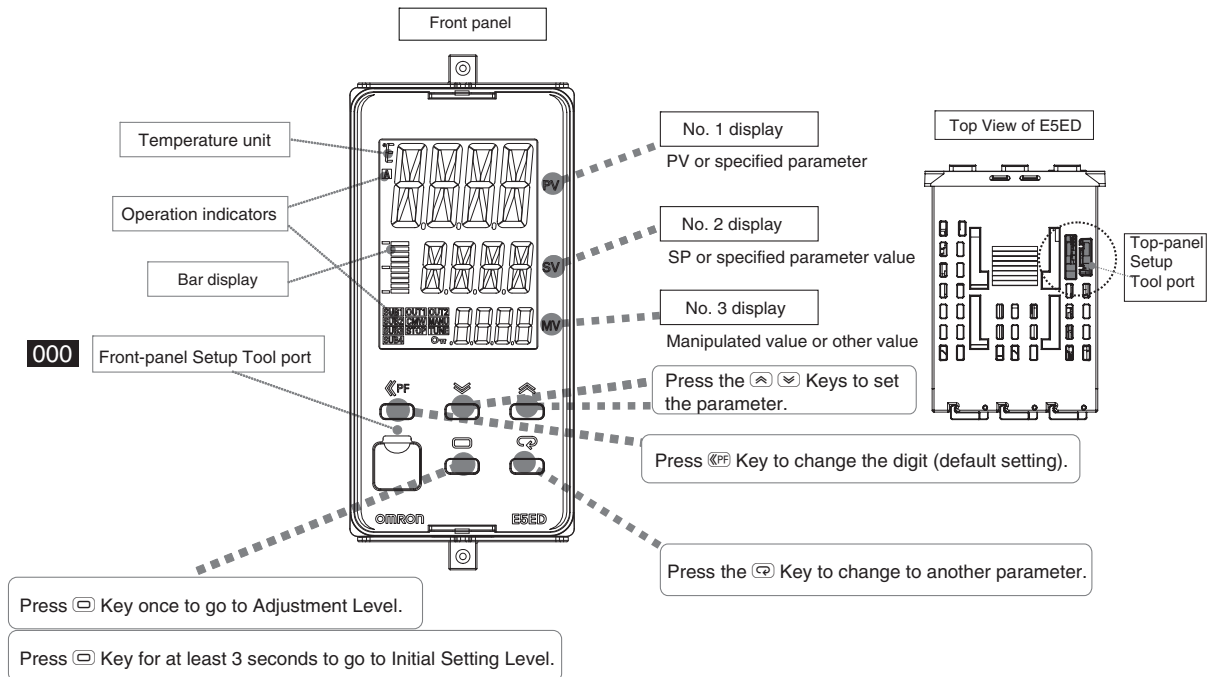





E5ED/E5ED-B

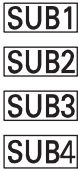





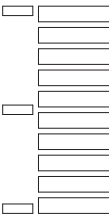





Displays

Name	Description
No. 1 display	Displays the process value or a monitor/setting item.
No. 2 display	Displays the set point or the value of a monitor/setting item.
No. 3 Display (E5ED and E5ED-B only)	Displays the manipulated variable, remaining soak time, multi-SP No., internal SP (ramp SP), or alarm value 1. (The value that is displayed is set in the PV/SP Display Selection parameter in the Advanced Function Setting Level.)
Temperature unit	Displays the temperature unit (°C or °F).

Indicators

Operation indicators	Name	Description
	Auxiliary outputs 1 to 4 (Only the E5ED and E5ED-B have auxiliary outputs 3 and 4.)	Each indicator lights when the function that is assigned to corresponding auxiliary output (1 to 4) is ON.
	Control outputs 1 and 2 (Only the E5ED and E5ED-B have control output 2.)	Each indicator lights when the function that is assigned to corresponding control output (1 or 2) is ON. (For a linear current output, the indicator is not lit for values below 0%.)
	Communications writing	This indicator lights when wiring with communications is enabled.
	Manual	This indicator is lit in Manual Mode.
	Stop	This indicator is lit while operation is stopped.
	AT execution in progress	This indicator is lit during autotuning.
	Adaptive control in progress	This indicator is flashing or lit during adaptive control.
	Bar display	This bar display indicates the manipulated value or heater current.
	Setting change protection	This indicator is lit while setting change protection is ON.

Keys



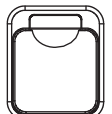

Key	Name	Overview	Description
	Level Key	<p>Selects the setting level.</p> <p>The next setting level depends on how long the key is pressed.</p>	<ul style="list-style-type: none"> In Operation Level <ul style="list-style-type: none"> Press once for less than 1 second to go to Adjustment Level. Press for at least 3 seconds to go to Initial Setting Level. In Adjustment Level <ul style="list-style-type: none"> Press once for less than 1 second to go to Operation Level. Press for at least 3 seconds to go to Initial Setting Level. In Initial Setting Level <ul style="list-style-type: none"> Press for at least 1 second to go to Operation Level.
	Mode Key	Changes the parameter that is displayed within a setting level.	<ul style="list-style-type: none"> Press once to go to the next parameter. Hold to go to the previous parameter.
 	Down Key and Up Key	Set the value.	<ul style="list-style-type: none"> Hold the key to increment or decrement the value quickly. Any changes in settings are applied at the following times: <ul style="list-style-type: none"> After 3 seconds elapse When the  Key is pressed When the level is changed with the  Key
	Shift Key (PF Key)	Operates as a user-defined function key.	<ul style="list-style-type: none"> Press the  Key for less than 1 second to select the digit to change. The key operates as a Shift Key to change the digit by one digit every time you press the key (default setting). You can change the PF Setting parameter in the Advanced Setting Level to assign any of the following functions to the  Key. Run/stop, auto/manual, autotune, cancel alarm latch, display monitor/setting item, digit shift (default), PID update (adaptive control), automatic filter adjustment, or water-cooling output adjustment <p>Example: If you set the PF Setting parameter in the Advanced Setting Level to $\overline{5} \overline{L} \overline{0} \overline{P}$, operation will be stopped when you press the  Key for 1 second or longer.</p> <ul style="list-style-type: none"> If you set $PF \overline{d} \overline{F}$ (monitor/setting items), each time you press the  Key for less than 1 second, the display is changed in order for the items that are set for the Monitor/Setting Item 1 to 5 parameters.

Setup Tool Ports 000

Setup Tool port	Name	Description
	Setup Tool port (card edge type)	Use the E58-CIFQ2 USB-Serial Conversion Cable to connect the E5□D to the computer (i.e., the CX-Thermo Support Software). E5CD, E5ED, E5CD-B, or E5ED-B: On top panel
	Setup Tool port (pin jack)	Use the E58-CIFQ2 USB-Serial Conversion Cable and the E58-CIFQ2-E Conversion Cable to connect the E5ED or E5ED-B to the computer (i.e., the CX-Thermo Support Software). E5ED or E5ED-B: On front panel



3-3-2 Entering Numeric Values

Applying Changes to Numeric Values

After you change a numeric value with the   Keys, the changes are applied 1) when 3 seconds elapses, 2) when the  Key is pressed, or 3) when the level is changed with the  Key.





Precautions for Correct Use

Always make sure that any changes to numeric values are applied for one of the three methods that are given above before you turn OFF the power supply to the E5□D.
If you only change the values with the   Keys and turn OFF the power supply before 3 seconds has elapsed, the changes will not be applied.

Moving between Digits (Digit Shift Key)

Press the Shift Key (PF Key) to select the digit to change.

This is useful when entering a numeric value with many digits.

Use this key to change levels: The digit to change will move as follows: 1s digit, 10s digit, 100s digit, 1000s digit, and then back to the 1s digit. Press the  +  Keys to change the value of a digit.

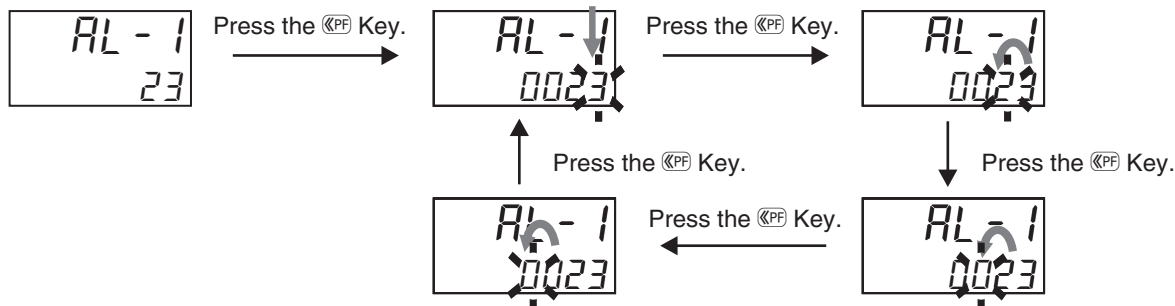

3-3-3 Setting Levels

On the E5□D, the parameters are classified into levels according to their applications. These levels are called setting levels. The setting levels consist of some basic setting levels and other setting levels.

Moving between Setting Levels

The following figure gives an overall image of the setting levels. The setting levels consist of the basic setting levels (shaded below) and the other setting levels (not shaded).

The Initial Setting Level, Communications Setting Level, Advanced Function Setting Level, and Calibration Level can be used only when control is stopped. If you change to any of these levels, control will stop.

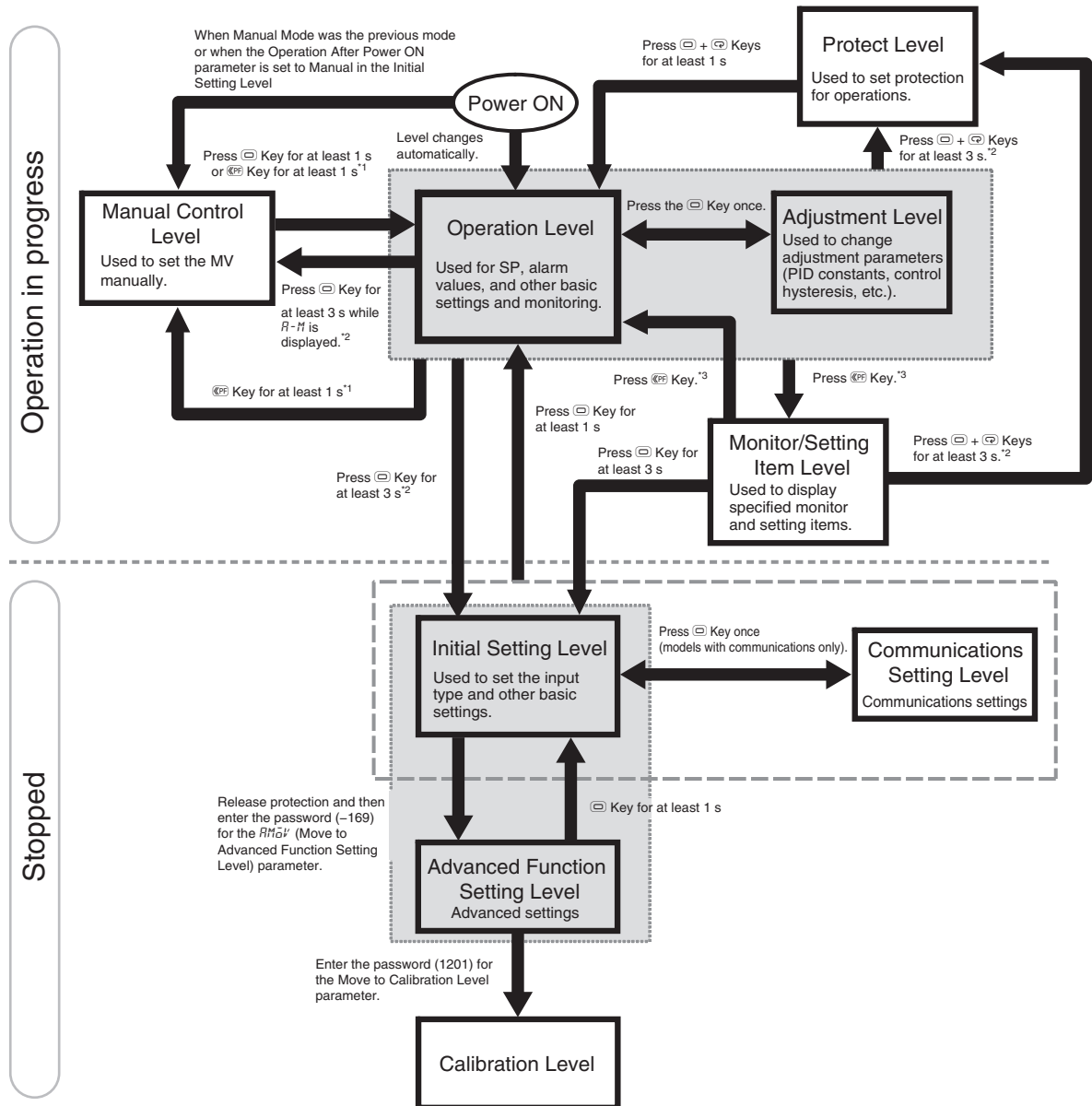

*1 Set the Auto/Manual Select Addition parameter to ON and set the PF Setting parameter to $R-M$ (Auto/Manual).
 *2 The No. 1 display will flash when the keys are pressed for 1 s or longer.
 *3 Set the PF Setting parameter to $PFdP$ (monitor/setting items).

Basic Setting Levels

● Operation Level

This level is displayed automatically when the power supply is turned ON.
 This level is used for the SP, alarm values, and other basic settings and monitoring.
 Normally, select this level for operation.

● Adjustment Level

This level is used to set the PID constants and to perform tuning, such as autotuning.
 In Adjustment Level, the settings of the parameters can be changed during operation. This is not possible in the Initial Setting Level or Advanced Function Setting Level.

● Initial Setting Level

This level is used for the most basic settings.
 It is used to set the input type and other parameters.
 Use it to set the input type, alarm type, and other basic settings.

● Advanced Function Setting Level

This level is used for advanced settings.
 Use it to assign functions to the control outputs and auxiliary outputs.
 You will not be able to enter the Advanced Function Setting Level with the default settings.
 To enter the Advanced Function Setting Level, first disable Initial Setting/Communications Protection and then enter the password (-169) at the *RM0V* (Move to Advanced Function Setting Level) parameter in the Initial Setting Level.
 Use the following procedure to move to Advanced Function Setting Level.

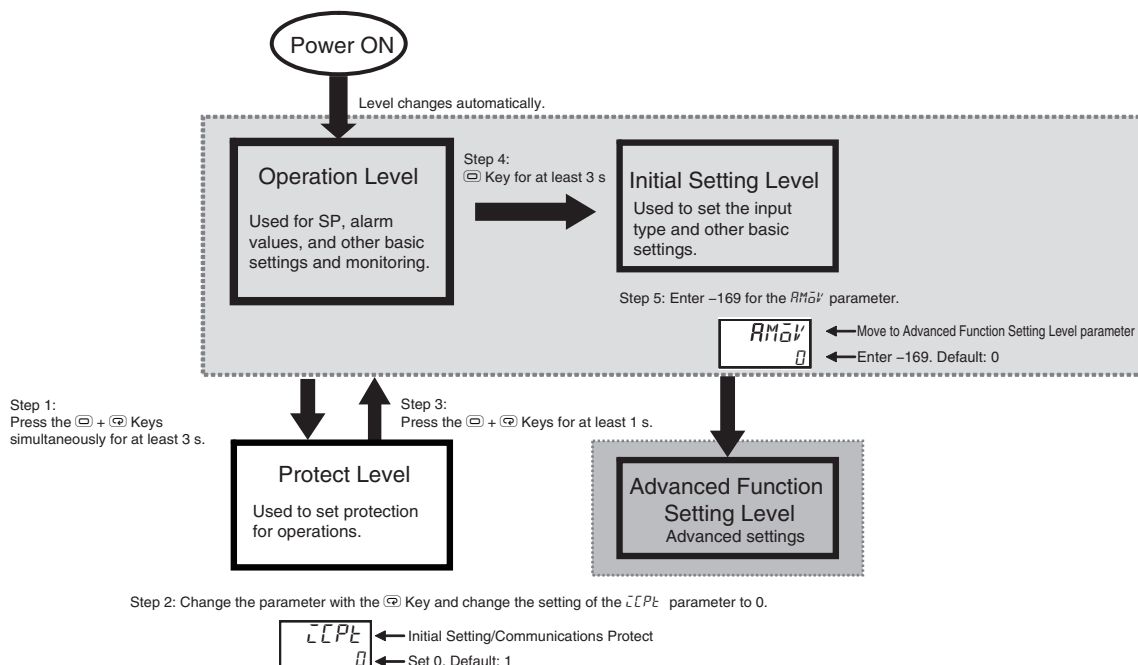

- Step 1: Move to Protect Level.
- Step 2: Display *LCP* (Initial Setting/Communications Protect) and set it to 0.
- Step 3: Return to Operation Level.
- Step 4: Return to Initial Setting Level.
- Step 5: Display *RM0V* (Move to Advanced Function Setting Level) and then enter -169.

Steps 1 to 3 are necessary only the first time. Perform only steps 4 and 5 to move to Advanced Function Setting Level.

Other Setting Levels

There are five other setting levels: Manual Control Level, Protect Level, Communications Setting Level, Calibration Level, and Monitor/Setting Item Level.

● Manual Control Level

This level is used to set the MV manually. With the default settings, you cannot move to the Manual Control Level.

- To use the \llcorner PF Key to move to the Manual Control Level, change the setting of the PF Setting parameter to *M*.
- You can use the Level Key on the Auto/Manual Switch Display to move to the Manual Control Level.
- To use an event input to move to the Manual Control Level, change the setting of the Event Input Assignment 1 to 6 parameter to *MANU*.

● Protect Level

This level is used to restrict the operations that can be performed and the parameters that can be displayed with the front-panel keys. For example, you can prohibit changing the SP and other parameters in the Operation Level and Adjustment Level. You can move to the Protect Level from the Operation Level or the Adjustment Level. To move to the Advanced Function Setting Level, you must first cancel the protection that is set in the Protect Level.

● Communications Setting Level

This level is used to set the communications parameters. You can move to the Communications Setting Level from the Initial Setting Level.

● Calibration Level

This level is used to calibrate the Digital Controller. You can move to the Calibration Level from the Advanced Function Setting Level.

● Monitor/Setting Item Level

To use the \llcorner PF Key to display the Monitor/Setting Items, change the setting of the PF Setting parameter to *PF dP*. The items that will be displayed in the Monitor/Setting Item Level are set using the Monitor/Setting Item 1 to 5 parameters.

3-4 Procedures after Turning ON the Power Supply

3-4-1 Basic Flow of Operations

The basic flow of operations after you turn ON the power supply is shown below.

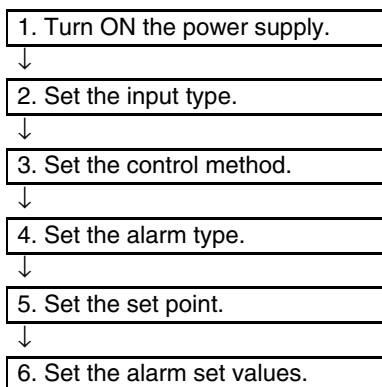

3-4-2 Basic Procedure

The basic procedure is given below.

1 Turn ON the power supply.

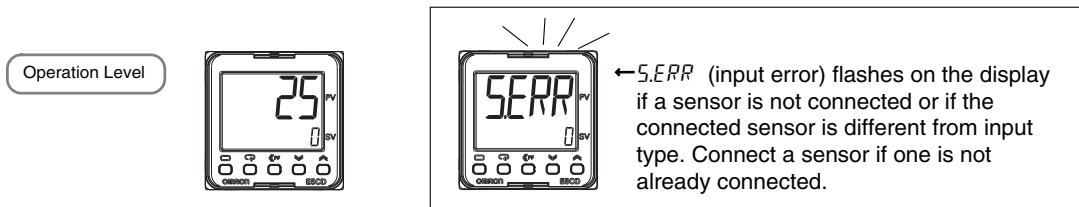

2 Set the input type.

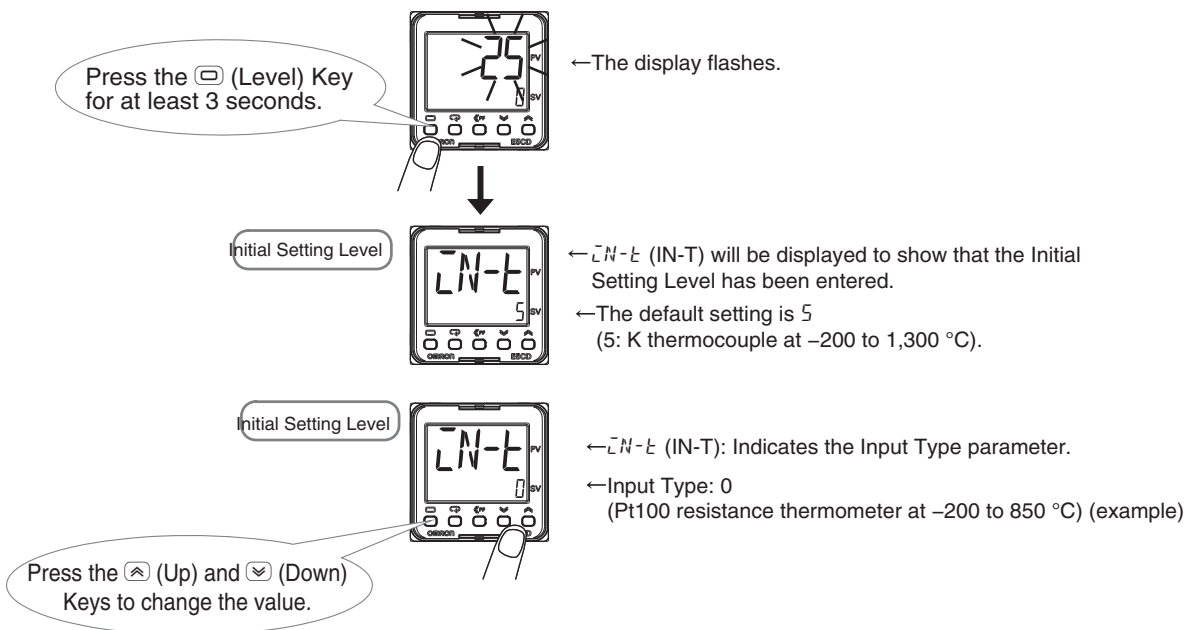

When you are finished, press the (Level) Key for at least 1 second to return to the operation display.

List of Input Types

	Input type	Specifications	Set value	Temperature range in °C	Temperature range in °F
Temperature input	Resistance thermometer	Pt100	0	-200 to 850	-300 to 1500
			1	-199.9 to 500.0	-199.9 to 900.0
		JPt100	2	0.0 to 100.0	0.0 to 210.0
			3	-199.9 to 500.0	-199.9 to 900.0
	Thermocouple	K	4	0.0 to 100.0	0.0 to 210.0
			5	-200 to 1300	-300 to 2300
		J	6	-20.0 to 500.0	0.0 to 900.0
			7	-100 to 850	-100 to 1500
		T	8	-20.0 to 400.0	0.0 to 750.0
			9	-200 to 400	-300 to 700
		E	10	-199.9 to 400.0	-199.9 to 700.0
			11	-200 to 600	-300 to 1100
		L	12	-100 to 850	-100 to 1500
			13	-200 to 400	-300 to 700
		U	14	-199.9 to 400.0	-199.9 to 700.0
			15	-200 to 1300	-300 to 2300
		R	16	0 to 1700	0 to 3000
			17	0 to 1700	0 to 3000
		B	18	0 to 1800	0 to 3200
			19	0 to 2300	0 to 3200
C/W	20	0 to 1300	0 to 2300		
	21	0 to 1300	0 to 2300		
Infrared temperature sensor ES1B	10 to 70°C	21	0 to 90	0 to 190	
	60 to 120°C	22	0 to 120	0 to 240	
	115 to 165°C	23	0 to 165	0 to 320	
	140 to 260°C	24	0 to 260	0 to 500	
Analog input	Current input	4 to 20 mA	25	One of the following ranges according to the scaling: -1999 to 9999 -199.9 to 999.9 -19.99 to 99.99 -1.999 to 9.999	
		0 to 20 mA	26		
	Voltage input	1 to 5 V	27		
		0 to 5 V	28		
		0 to 10 V	29		

The default is 5.

3 Set the control method.

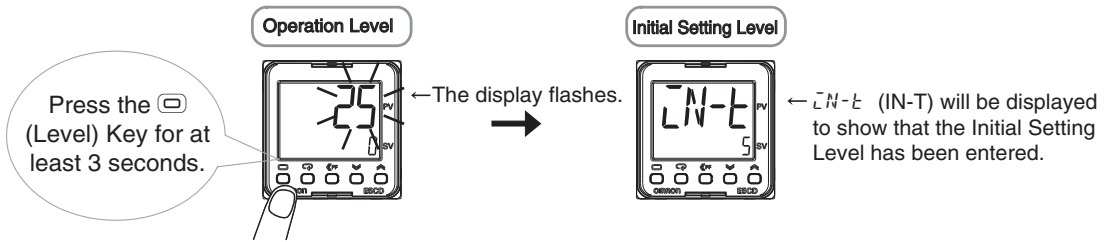

Standard Models

PID Control

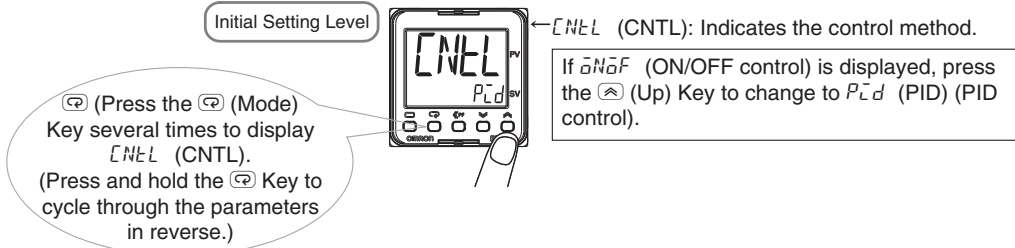

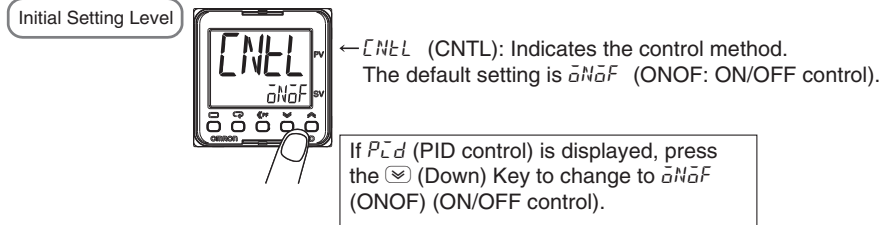

ON/OFF Control

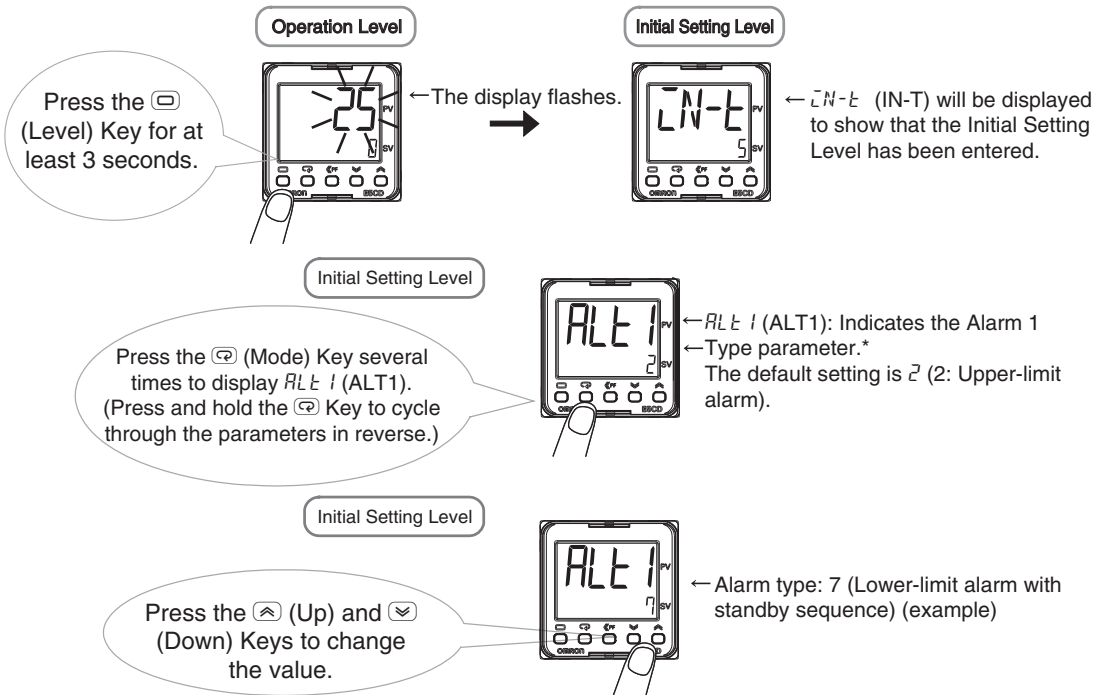

4 Set the alarm type.



* If the Digital Controller is equipped with HB/HS alarm detection, the Alarm 1 Type is not displayed for the default settings. To use alarm 1, set an output assignment to alarm 1. For details, refer to 4-6-3 Assigned Output Functions.

If required, use the  (Mode) Key and the  (Up) and  (Down) Keys to repeat the procedure to set alarm types for AL2 (ALT2) (Alarm 2 Type), AL3 (ALT3) (Alarm 3 Type), and AL4 (ALT4) (Alarm 4 Type). (The number of alarms that is supported depends on the model of Digital Controller. Some of the alarm parameters may not be displayed.)

When you are finished, press the  (Level) Key for at least 1 second to return to the operation display.

Alarm Type Numbers

Set value	Alarm type	Description	Operation
0	Alarm function OFF	There will be no alarm outputs.	---
1	Upper- and lower-limit alarm	The alarm output is ON while the PV is equal to or higher than the upper-limit alarm point or while the PV is equal to or lower than the lower-limit alarm point.	Example:
2	Upper-limit alarm	The alarm output is ON while the PV is equal to or higher than the upper-limit alarm point.	Example:
3	Lower-limit alarm	The alarm output is ON while the PV is equal to or lower than the lower-limit alarm point.	Example:
4	Upper- and lower-limit range alarm	The alarm output is ON while the PV is equal to or lower than the upper-limit alarm point or equal to or higher than the lower-limit alarm point.	Example:
5	Upper- and lower-limit alarm with standby sequence	This alarm provides a standby sequence. The alarm output is ON while the PV is equal to or higher than the upper-limit alarm point or while the PV is equal to or lower than the lower-limit alarm point.	Example:
6	Upper-limit alarm with standby sequence	This alarm provides a standby sequence. The alarm output is ON while the PV is equal to or higher than the upper-limit alarm point.	Example:
7	Lower-limit alarm with standby sequence	This alarm provides a standby sequence. The alarm output is ON while the PV is equal to or lower than the lower-limit alarm point.	Example:

Set value	Alarm type	Description	Operation
<i>8</i>	Absolute-value upper-limit alarm	The alarm output is ON while the PV is equal to or higher than the alarm value.	Example: <p>The graph shows a horizontal line for 'Temperature' with a vertical axis for 'ON' and 'OFF'. A horizontal line at the bottom represents the 'Alarm value (e.g., 100°C)'. An arrow points to the 'Upper-limit alarm point (e.g., 100°C)' on the temperature line. The alarm output (shaded area) turns ON when the temperature reaches this point and remains ON as long as the temperature is at or above the alarm value.</p>
<i>9</i>	Absolute-value lower-limit alarm	The alarm output is ON while the PV is equal to or lower than the alarm value.	Example: <p>The graph shows a horizontal line for 'Temperature' with a vertical axis for 'ON' and 'OFF'. A horizontal line at the bottom represents the 'Alarm value (e.g., 100°C)'. An arrow points to the 'Lower-limit alarm point (e.g., 100°C)' on the temperature line. The alarm output (shaded area) turns ON when the temperature reaches this point and remains ON as long as the temperature is at or below the alarm value.</p>
<i>10</i>	Absolute-value upper-limit alarm with standby sequence	This alarm provides a standby sequence. The alarm output is ON while the PV is equal to or higher than the alarm value.	Example: <p>The graph is similar to the absolute-value upper-limit alarm, but the shaded area representing the alarm output starts with a delay after the temperature reaches the alarm point, indicating a standby sequence.</p>
<i>11</i>	Absolute-value lower-limit alarm with standby sequence	This alarm provides a standby sequence. The alarm output is ON while the PV is equal to or lower than the alarm value.	Example: <p>The graph is similar to the absolute-value lower-limit alarm, but the shaded area representing the alarm output starts with a delay after the temperature reaches the alarm point, indicating a standby sequence.</p>
<i>12</i>	Loop Burnout Alarm (LBA) (Valid only for alarm 1.)	The alarm output turns ON when the control loop is broken.	<p>There is assumed to be a loop burnout alarm if the control deviation ($SP - PV$) is greater than the threshold set in the LBA Level parameter and if the PV is not reduced by at least the value set in the LBA Band parameter within a specific period of time. The LBA detection time and LBA band are set in parameters.</p> <p>The graph shows four variables over time: <ul style="list-style-type: none"> PV (Process Variable): A curve that starts at a setpoint (SP) and begins to rise, crossing the LBA level and staying above it for a duration labeled 'LBA detection time'. The 'LBA band' is the vertical distance between the PV curve and the LBA level. SP (Setpoint): A constant horizontal line. MV (Manipulated Variable): A step function that starts at 100% and drops to 0% when the LBA is detected. LBA Alarm Output: A step function that turns ON (shaded area) at the moment the LBA is detected and remains ON. </p>

Set value	Alarm type	Description	Operation
13	PV change rate alarm	The alarm output turns ON if the change in the PV within the specified calculation period exceeds a specific width.	<p>The PV rate of change calculation period and the alarm value are set in parameters.</p>
14	SP absolute-value upper-limit alarm	The alarm output is ON while the SP is equal to or higher than the alarm value.	<p>Example:</p>
15	SP absolute-value lower-limit alarm	The alarm output is ON while the SP is equal to or lower than the alarm value.	<p>Example:</p>
16	MV absolute-value upper-limit alarm	The alarm output is ON while the MV is equal to or higher than the alarm value.	<p>Example for Standard Control:</p>
17	MV absolute-value lower-limit alarm	The alarm output is ON while the MV is equal to or lower than the alarm value.	<p>Example for Standard Control:</p>

5 Set the set point.

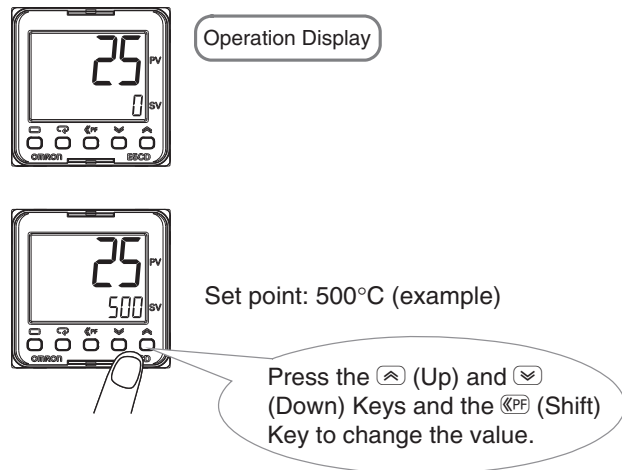

*Hold the (Up) or (Down) Key to increment or decrement the value quickly.

6 Set the alarm set value or values.

Change the parameter that is displayed with the (Mode) Key.

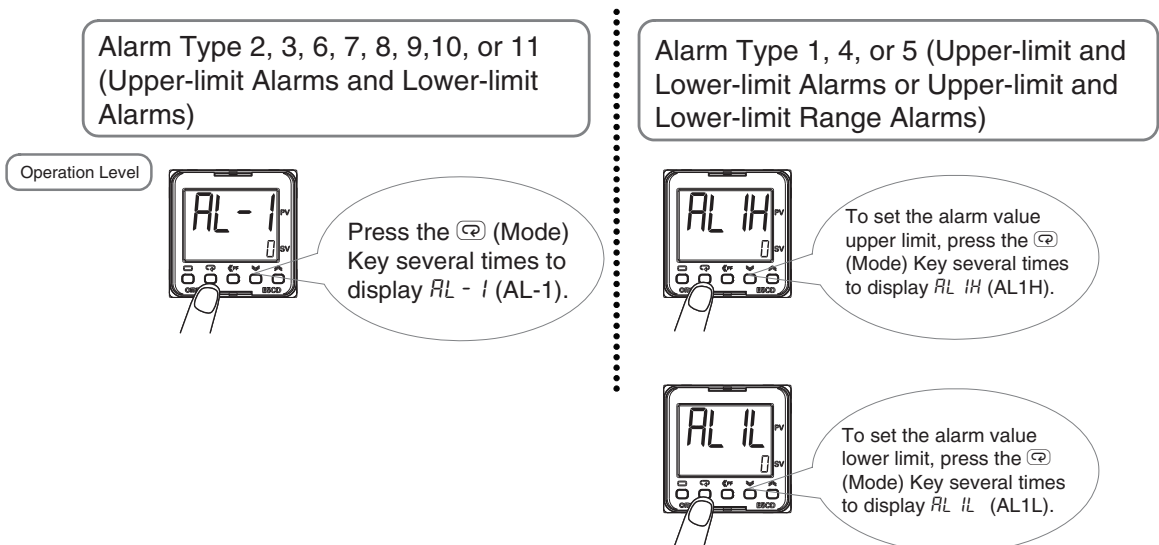

This concludes the procedure to set the input type, alarm type, control method, set point, and alarm set values. For information on the settings of the ON/OFF hysteresis, PID constants, HS alarm, HS alarm, and other parameters, refer to *Section 4 Basic Operation* or *Section 5 Advanced Operations*.

4

Basic Operation

4-1	Moving between Setting Levels	4-3
4-1-1	Moving to the Initial Setting Level	4-3
4-1-2	Moving to the Adjustment Level	4-4
4-1-3	Moving to the Protect Level	4-4
4-1-4	Moving to the Advanced Function Setting Level	4-5
4-1-5	Moving to the Communications Setting Level	4-7
4-2	Initial Setting Examples	4-8
4-3	Setting the Input Type	4-11
4-3-1	Input Type	4-11
4-4	Selecting the Temperature Unit	4-13
4-4-1	Temperature Unit	4-13
4-5	Selecting PID Control or ON/OFF Control	4-14
4-6	Setting Output Specifications	4-15
4-6-1	Control Period	4-15
4-6-2	Direct and Reverse Operation	4-15
4-6-3	Assigned Output Functions	4-16
4-6-4	Auxiliary Output Opening or Closing in Alarm	4-19
4-7	Setting the Set Point (SP)	4-20
4-7-1	Changing the SP	4-20
4-8	Using ON/OFF Control	4-21
4-8-1	ON/OFF Control	4-21
4-8-2	Settings	4-22
4-9	Determining PID Constants (AT, Manual Setup)	4-24
4-9-1	AT (Auto-tuning)	4-24
4-9-2	RT (Robust Tuning) (Use with AT)	4-27
4-9-3	Manual Setup	4-29
4-10	Alarm Outputs	4-31
4-10-1	Alarm Types	4-31
4-10-2	Alarm Values	4-34

4-11 Alarm Hysteresis 4-37
4-11-1 Standby Sequence 4-37
4-11-2 Alarm Latch 4-38

4-12 Using Heater Burnout (HB) and Heater Short (HS) Alarms 4-39
4-12-1 HB Alarm 4-39
4-12-2 HS Alarm 4-41
4-12-3 Installing Current Transformers (CT) 4-43
4-12-4 Calculating Detection Current Values 4-44
4-12-5 Application Examples 4-44

4-13 Customizing the PV/SP Display 4-46
4-13-1 PV/SP Display Selections 4-46

4-1 Moving between Setting Levels

The Operation Level is displayed first when the power supply to the Digital Controller is turned ON. To display the parameters, you must move to the following setting levels.

- Operation Level (Entered when the power supply is turned ON.)
- Initial Setting Level
- Adjustment Level
- Protect Level
- Advanced Function Setting Level
- Communications Setting Level

The procedures to move between the setting levels starting from the Operation Level are provided below.

4-1-1 Moving to the Initial Setting Level

Moving from the Operation Level to the Initial Setting Level

1 Press the Key for at least 3 seconds in the Operation Level.

The No. 1 display will flash when the key is pressed for 1 s or longer.

The display will change from the Operation Level to the Initial Setting Level.

Operation Level

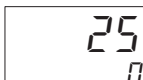

Initial Setting Level

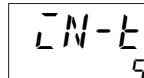

Moving from the Initial Setting Level to the Operation Level

1 Press the Key for at least 1 second in the Initial Setting Level.

The display will change from the Initial Setting Level to the Operation Level.

Initial Setting Level

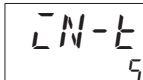

Operation Level

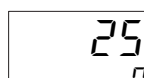

4-1-2 Moving to the Adjustment Level

Moving from the Operation Level to the Adjustment Level

- 1** Press the  Key for less than 1 second in the Operation Level.

The display will change from the Operation Level to the Adjustment Level.

* *L.ADJ* will be displayed only once when you move to the Adjustment Level.

Operation Level



Adjustment Level

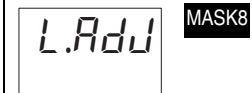

Moving from the Adjustment Level to the Operation Level

- 1** Press the  Key for less than 1 second in the Adjustment Level.

The display will change from the Adjustment Level to the Operation Level.

Adjustment Level

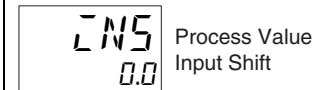

Operation Level

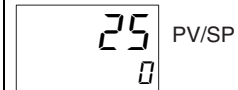

4-1-3 Moving to the Protect Level

Moving from the Operation Level to the Protect Level

- 1** Press the  and  Keys simultaneously for at least 3 seconds* in the Operation Level.

The No. 1 display will flash when the keys are pressed for 1 s or longer.

* The key pressing time can be changed in the Move to Protect Level Time parameter in the Advanced Function Setting Level.

The display will change to the Protect Level.

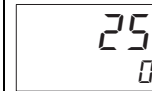

Operation Level

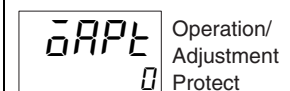

Protect Level



Moving from the Protect Level to the Operation Level

- 1** Press the  and  Keys simultaneously for at least 1 second in the Protect Level.

The display will change from the Protect Level to the Operation Level.

Protect Level

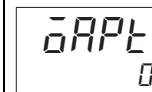

Operation Level

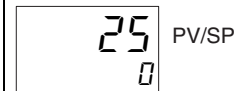



4-1-4 Moving to the Advanced Function Setting Level

Moving to the Advanced Function Setting Level for the First Time (i.e., with the Default Settings)

To enter the Advanced Function Setting Level, you must first enter the Protect Level and change the setting of the $\overline{\text{LCP}}\text{L}$ (Initial Setting/Communications Protect) parameter to 0 (enable moving to Advanced Function Setting Level) to clear the protection.

● Clearing Protection

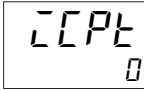
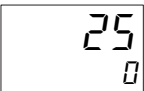
<p>1 Press the ⏏ and ⏏ Keys simultaneously for at least 3 seconds* in the Operation Level.</p> <p>The No. 1 display will flash when the key is pressed for 1 s or longer.</p> <p>* The key pressing time can be changed in the Move to Protect Level Time parameter in the Advanced Function Setting Level.</p> <p>The display will change to the Protect Level.</p>	<p>Operation Level</p> 
<p>2 Press the ⏏ Key once at the Operation/Adjustment Protect parameter.</p> <p>The display will change to the Initial Setting/Communications Protect parameter.</p>	<p>Protect Level</p>  <p>Operation/Adjustment Protect</p>
<p>3 Press the ⏏ or ⏏ Key at the Initial Setting/Communications Protect parameter to change the set value to 0 (enable moving to Advanced Function Setting Level).</p> <p>Now the $\overline{\text{AMOV}}$ (Move to Advanced Function Setting Level) parameter can be displayed in the Initial Setting Level.</p> <p>The default is 1 (disable moving to Advanced Function Setting Level).</p>	<p>$\overline{\text{LCP}}\text{L}$ 1</p> <p>Initial Setting/Communications Protect</p> <p>1: Moving to Advanced Function Setting Level is disabled.</p>
<p>4 Press the ⏏ and ⏏ Keys simultaneously for at least 1 second in the Protect Level.</p> <p>The display will change from the Protect Level to the Operation Level.</p>	<p>Protect Level</p>  <p>Initial Setting/Communications Protect</p> <p>Operation Level</p>  <p>PV/SP</p>

Moving to the Advanced Function Setting Level after Clearing Protection

After you have set the $\overline{C}P\overline{E}$ (Initial Setting/Communications Protect) parameter to $\overline{0}$ (enable moving to Advanced Function Setting Level), select $AM\overline{O}V$ (Move to Advanced Function Setting Level) in the Initial Setting Level.

● Moving to the Advanced Function Setting Level

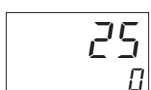
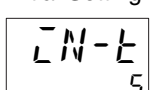
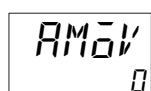
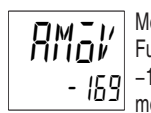
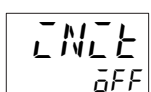

<p>1 Press the $\overline{\text{C}}\overline{\text{P}}\overline{\text{E}}$ Key for at least 3 seconds in the Operation Level. The No. 1 display will flash when the key is pressed for 1 s or longer. The display will change from the Operation Level to the Initial Setting Level.</p>	<p>Operation Level</p> 
<p>2 Press the $\overline{\text{M}}\overline{\text{O}}\overline{\text{V}}$ Key several times in the Initial Setting Level (or hold it down to move through the parameters in reverse) to display the Move to Advanced Function Setting Level parameter. The display will change to $AM\overline{O}V$ (Move to Advanced Function Setting Level).</p>	<p>Initial Setting Level</p>  Input Type
<p>3 Press the $\overline{\text{U}}\overline{\text{P}}$ and $\overline{\text{D}}\overline{\text{O}}\overline{\text{W}}\overline{\text{N}}$ Keys at the Move to Advanced Function Setting Level parameter and then enter -169. * You can hold the $\overline{\text{U}}\overline{\text{P}}$ (Up) or $\overline{\text{D}}\overline{\text{O}}\overline{\text{W}}\overline{\text{N}}$ (Down) Key to increment or decrement the set value quickly.</p>	<p>Initial Setting Level</p>  Move to Advanced Function Setting Level
<p>4 Press $\overline{\text{M}}\overline{\text{O}}\overline{\text{V}}$ Key once or wait for 2 seconds or longer without doing anything. The display will change to the Advanced Function Setting Level.</p>	<p> Move to Advanced Function Setting Level -169: Password to move to Advanced Function Setting Level</p> <p>Advanced Function Setting Level</p>  Parameter Initialization

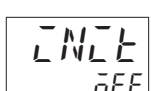
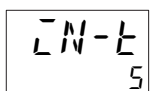
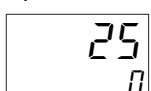
● Moving from the Advanced Function Setting Level to the Operation Level

<p>1 Press the $\overline{\text{C}}\overline{\text{P}}\overline{\text{E}}$ Key for at least 1 second in the Advanced Function Setting Level. The display will change from the Advanced Function Setting Level to the Initial Setting Level.</p>	<p>Advanced Function Setting Level</p> 
<p>2 Press the $\overline{\text{C}}\overline{\text{P}}\overline{\text{E}}$ Key for at least 1 second in the Initial Setting Level. The display will change from the Initial Setting Level to the Operation Level.</p>	<p>Initial Setting Level</p>  Input Type <p>Operation Level</p>  PV/SP

4-1-5 Moving to the Communications Setting Level

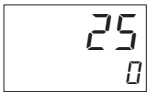

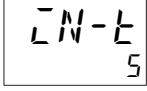
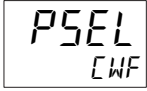
● Moving from the Operation Level to the Communications Setting Level

<p>1 Press the  Key for at least 3 seconds in the Operation Level. The No. 1 display will flash when the keys are pressed for 1 s or longer. The display will change from the Operation Level to the Initial Setting Level.</p>	<p>Operation Level</p> 
<p>2 Press the  Key for less than 1 second in the Initial Setting Level.</p> <p>The display will change from the Initial Setting Level to the Communications Setting Level.</p>	<p>Initial Setting Level</p>  <p>Input Type</p> <p>Communications Setting Level</p>  <p>Protocol Setting</p>

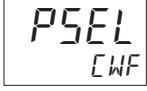
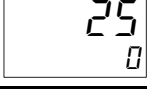
● Moving from the Communications Setting Level to the Operation Level

<p>1 Press the  Key for at least 1 second in the Communications Setting Level. The display will change from the Communications Setting Level to the Initial Setting Level.</p>	<p>Communications Setting Level</p>  <p>Operation Level</p>  <p>PV/SP</p>
---	---

4-2 Initial Setting Examples



Initial hardware setup, including the sensor input type, alarm types, control periods, and other settings, is done using parameter displays. The  and  Keys are used to switch between parameters, and the amount of time that you press the keys determines which parameter you move to.

This section describes three typical examples.

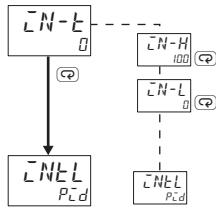

Explanation of Examples

Changing Parameters



A  image means that there are parameters. Continue pressing the  Key several times to change parameters until you reach the intended parameter.

Changing Numbers

 Numeric data and selections in each screen can be changed by using the  and  Keys.

Example 1

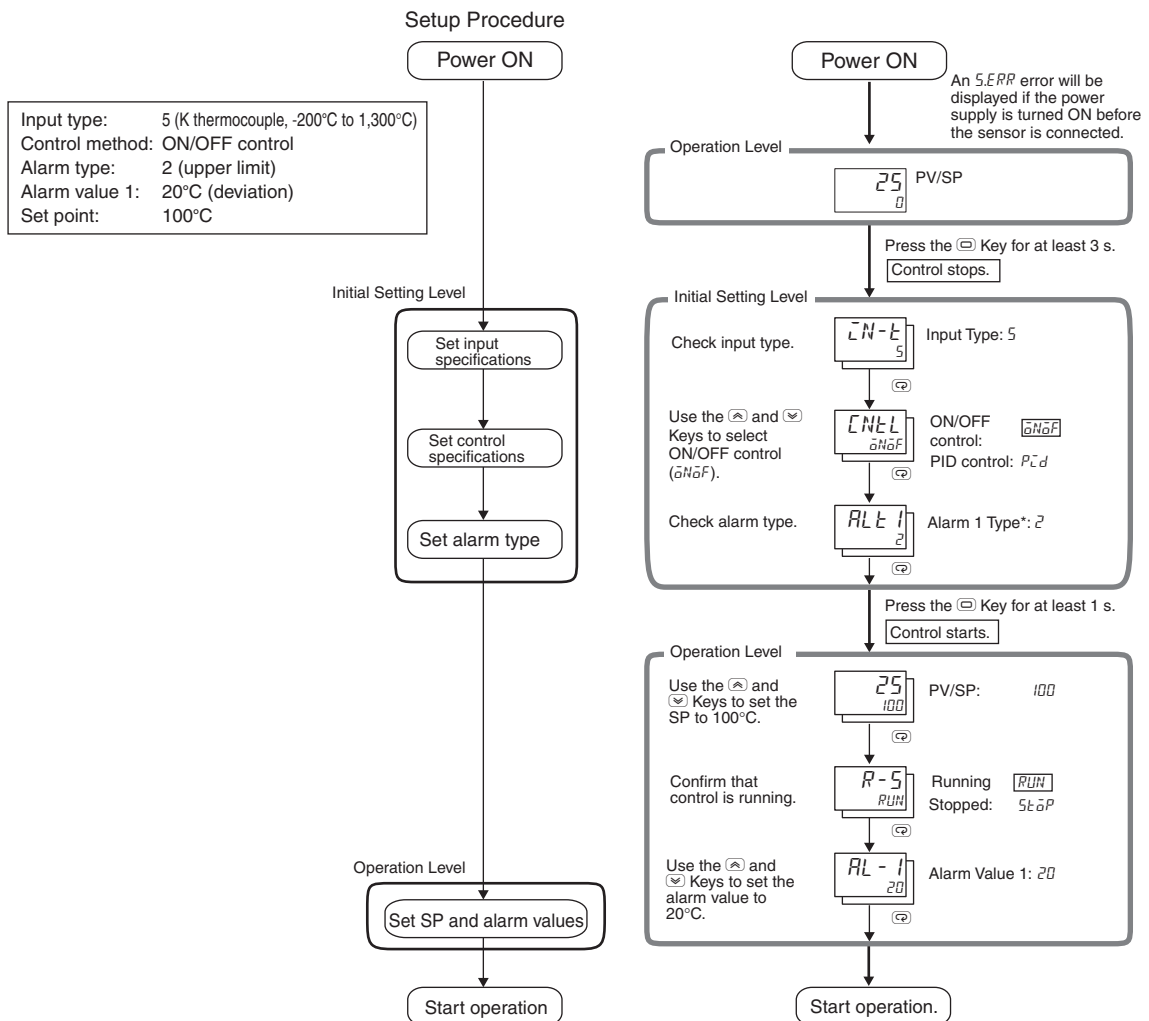

* If the Controller is equipped with HB/HS alarm detection, the default setting for the Auxiliary Output 1 Assignment is for heater alarms. Therefore, the alarm 1 function is disabled and the Alarm 1 Type is not displayed. To enable alarm 1, set an output assignment to alarm 1. For details, refer to *4-6-3 Assigned Output Functions*.



Additional Information

If you go past the desired parameter, hold down the Key to move through the parameters in reverse.

Example 2

Input type: 9 (T thermocouple, -200°C to 400°C)
 Control method: PID control
 PID constants found using auto-tuning (AT).
 Alarm type: 2 (upper limit)
 Alarm value 1: 30°C
 Set point: 150°C

Setup Procedure

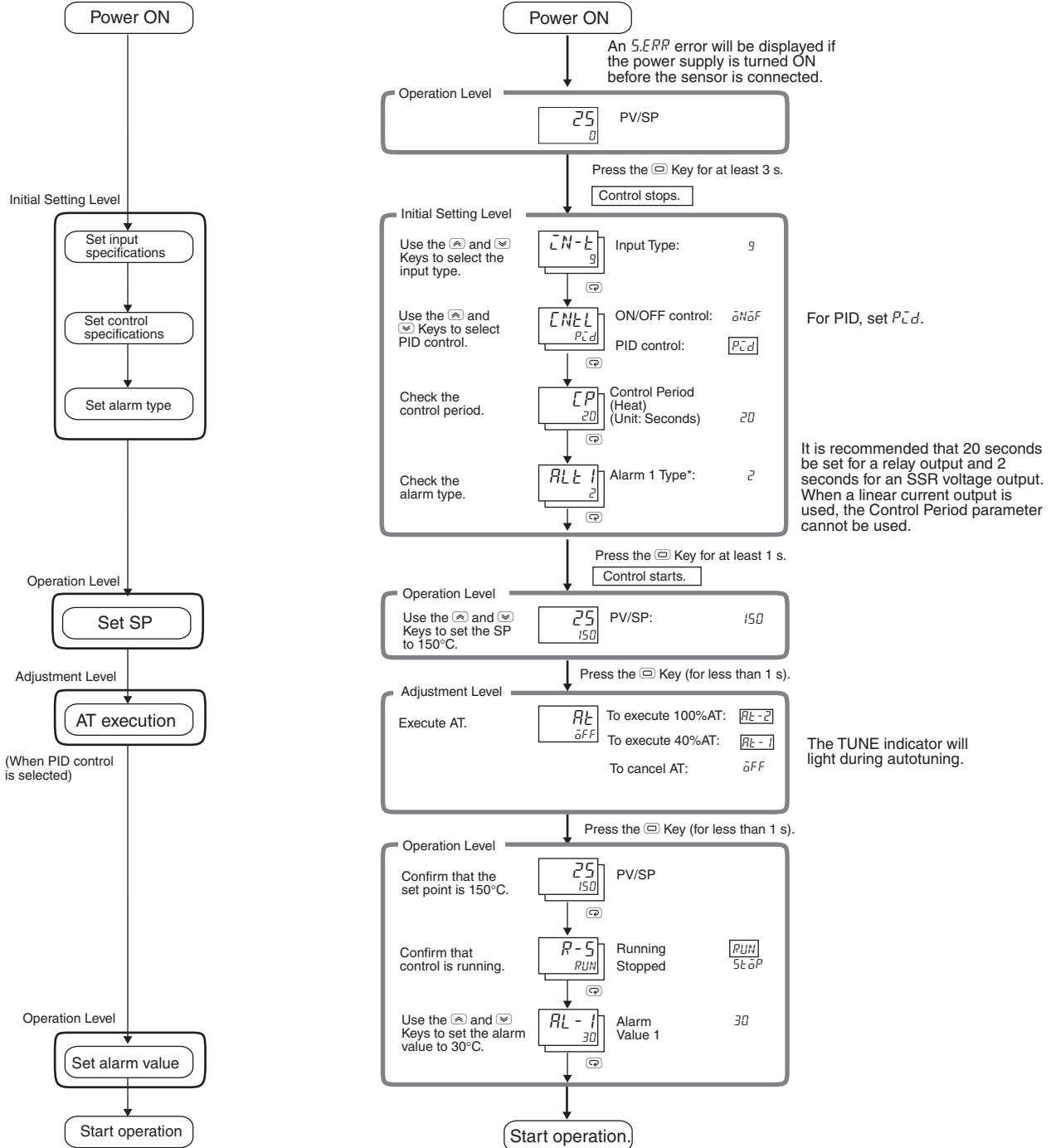

* If the Controller is equipped with HB/HS alarm detection, the default setting for the Auxiliary Output 1 Assignment is for heater alarms. Therefore, the alarm 1 function is disabled and the Alarm 1 Type is not displayed. To enable alarm 1, set an output assignment to alarm 1. For details, refer to 4-6-3 Assigned Output Functions.



4-3 Setting the Input Type

The Digital Controller supports four input types: resistance thermometer, thermocouple, infrared temperature sensor, and analog inputs. Set the input type that matches the sensor that is used.

4-3-1 Input Type



The following example shows how to set a K thermocouple for -20.0 to 500.0°C (input type 6).

Operating Procedure

<p>1 Press the  Key for at least 3 seconds to move from the Operation Level to the Initial Setting Level. The $\bar{L}N-E$ (Input Type) parameter will be displayed.</p>	<p>Initial Setting Level</p> <div style="border: 1px solid black; padding: 5px; display: inline-block;"> $\bar{L}N-E$ 5 </div> <p>Input Type</p>
<p>2 Press the  or  Key to select 6 (K thermocouple at -20.0 to 500.0°C). The default is 5 (5: K thermocouple at -200 to $1,300^{\circ}\text{C}$).</p>	<div style="border: 1px solid black; padding: 5px; display: inline-block;"> $\bar{L}N-E$ 6 </div>



Additional Information

Changes that are made with key operations are applied when the  or  Key is pressed. They are also applied if you do nothing for 3 seconds or longer.

List of Input Types

	Specifications	Set value	Temperature range in °C	Temperature range in °F	
Temperature input	Resistance thermometer	Pt100	0	-200 to 850	-300 to 1500
		1	-199.9 to 500.0	-199.9 to 900.0	
		2	0.0 to 100.0	0.0 to 210.0	
		JPt100	3	-199.9 to 500.0	-199.9 to 900.0
		4	0.0 to 100.0	0.0 to 210.0	
	Thermocouple	K	5	-200 to 1300	-300 to 2300
			6	-20.0 to 500.0	0.0 to 900.0
		J	7	-100 to 850	-100 to 1500
			8	-20.0 to 400.0	0.0 to 750.0
		T	9	-200 to 400	-300 to 700
			10	-199.9 to 400.0	-199.9 to 700.0
		E	11	-200 to 600	-300 to 1100
		L	12	-100 to 850	-100 to 1500
		U	13	-200 to 400	-300 to 700
			14	-199.9 to 400.0	-199.9 to 700.0
		N	15	-200 to 1300	-300 to 2300
		R	16	0 to 1700	0 to 3000
		S	17	0 to 1700	0 to 3000
		B	18	0 to 1800	0 to 3200
		C/W	19	0 to 2300	0 to 3200
PLII	20	0 to 1300	0 to 2300		
Infrared temperature sensor ES1B	10 to 70°C	21	0 to 90	0 to 190	
	60 to 120°C	22	0 to 120	0 to 240	
	115 to 165°C	23	0 to 165	0 to 320	
	140 to 260°C	24	0 to 260	0 to 500	
Analog input	Current input	4 to 20 mA	25	One of the following ranges according to the scaling: -1999 to 9999 -199.9 to 999.9 -19.99 to 99.99 -1.999 to 9.999	
		0 to 20 mA	26		
	Voltage input	1 to 5 V	27		
		0 to 5 V	28		
		0 to 10 V	29		

The default is 5.



Precautions for Correct Use

S.ERR (S.ERR: input error) flashes on the display if a sensor is not connected or if the connected sensor is different from input type. Connect a sensor if one is not already connected.

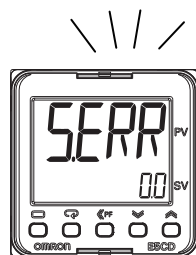

4-4 Selecting the Temperature Unit

4-4-1 Temperature Unit

- Either °C or °F can be selected as the temperature unit.
- Set the temperature unit in the Temperature Unit (*d-U*) parameter of the Initial Setting Level. The default is $\bar{\square}$ (°C).
- If you change the temperature unit, the units of temperature set values (e.g., the alarm values) will be automatically converted.

The following procedure selects °C.

Operating Procedure

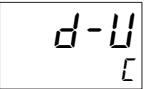
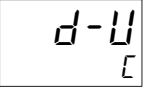
<p>1 Press the Ⓢ Key several times in the Initial Setting Level to display <i>d-U</i> (Temperature Unit).</p>	<p>Initial Setting Level</p> 
<p>2 Press the ⏏ or ⏏ Key to select °C. The default is $\bar{\square}$ (°C). $\bar{\square}$: °C, $\bar{\square}$: °F</p>	

4-5 Selecting PID Control or ON/OFF Control

Two control methods are supported: 2-PID control and ON/OFF control. Switching between 2-PID control and ON/OFF control is executed by means of the PID ON/OFF parameter in the initial setting level. When this parameter is set to $P\bar{L}d$, 2-PID control is selected, and when set to $\bar{O}N\bar{O}F$, ON/OFF control, is selected. The default is $P\bar{L}d$.

● 2-PID Control

Use autotuning to set the PID constants, or set them manually.

For PID control, set the PID constants in the Proportional Band (\bar{P}), Integral Time (\bar{I}), and Derivative Time (\bar{d}) parameters.

For heating and cooling control, also set the Proportional Band (Cooling) ($\bar{I}-\bar{P}$), Integral Time (Cooling) ($\bar{I}-\bar{I}$), and Derivative Time (Cooling) ($\bar{I}-\bar{d}$).

For details, refer to *4-7 Setting the Set Point (SP)*.

● ON/OFF Control

In ON/OFF control, the control output is turned ON when the process value is lower than the current set point, and the control output is turned OFF when the process value is higher than the current set point (reverse operation).

For details, refer to *4-8 Using ON/OFF Control*.

4-6 Setting Output Specifications

4-6-1 Control Period

 Control Period (Heating)

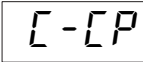
 Control Period (Cooling)

- Set the output periods (control periods). Though a shorter period provides better control performance, it is recommended that the control period be set to 20 seconds or longer for a relay output to preserve the service life of the relay. After the settings have been made in the initial setup, readjust the control period, as required, by means such as trial operation.
- Set the control periods in the Control Period (Heating) and Control Period (Cooling) parameters in the Initial Setting Level. The default is 20 seconds for a relay output and 2 seconds for a voltage output (for driving SSR).
- The control periods are used only for PID control.
- The Control Period (Cooling) parameter is used only for heating/cooling control.
- When control output is used as a linear current output, the Control Period parameter cannot be used.

4-6-2 Direct and Reverse Operation

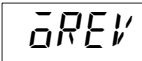

- Direct operation increases the manipulated variable whenever the process value increases. Reverse operation decreases the manipulated variable whenever the process value increases.

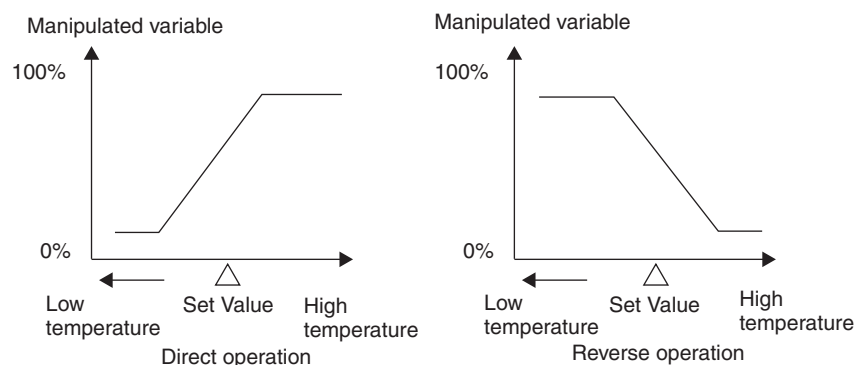

For example, when the process value (PV) is lower than the set point (SP) in a heating control system, the manipulated variable increases according to the difference between the PV and SP. Accordingly, reverse operation is used in a heating control system. Direct operation is used in a cooling control system, in which the operation is the opposite of a heating control system. The Control Output 1 Assignment is set to \bar{a} (control output (heating)) for either direct or reverse operation.

- Direct/reverse operation is set in the Direct/Reverse Operation parameter in the Initial Setting Level. The default is \bar{a}^R-R (reverse operation).

In this example, direct/reverse operation, and control period (heating) parameters are checked.
 Direct/reverse operation = $\bar{\alpha}R-R$ (reverse operation)
 Control period (heating) = 20 (seconds)

Operating Procedure

- Setting the Control Period (Heating) Parameter

<p>1 Press the ☰ Key several times in the Initial Setting Level to display CP (Control Period (Heating)).</p>	<p>Initial Setting Level</p> <div style="border: 1px solid black; padding: 5px; display: inline-block;"> CP 20 </div> <p>Control Period (Heating)</p>
<p>2 Press the ▲ or ▼ Key to set the value to 20. The default for a relay output is 20 seconds.</p>	<div style="border: 1px solid black; padding: 5px; display: inline-block;"> CP 20 </div>

- Setting Direct/Reverse Operation

<p>1 Press the ☰ Key several times in the Initial Setting Level to display $\bar{\alpha}REV$ (Direct/Reverse Operation).</p>	<p>Initial Setting Level</p> <div style="border: 1px solid black; padding: 5px; display: inline-block;"> $\bar{\alpha}REV$ $\bar{\alpha}R-R$ </div> <p>Direct/Reverse Operation</p>
<p>2 Press the ▲ or ▼ Key to select $\bar{\alpha}R-R$ (Reverse Operation). The default is $\bar{\alpha}R-R$ (Reverse Operation).</p>	<div style="border: 1px solid black; padding: 5px; display: inline-block;"> $\bar{\alpha}REV$ $\bar{\alpha}R-R$ </div>

4-6-3 Assigned Output Functions

- Function assignments can be changed by changing the settings for control and auxiliary output assignments.
- The default function assignments for each output are shown below.
- During tuning,* ensure that the power for the load (e.g., heater) is ON. If the power supply to the load (e.g., heater) is not turned ON during tuning, tuning results will not be calculated correctly and it will not be possible to achieve optimum control.
 - * “Tuning” refers to the following functions: AT, adaptive control, automatic filter adjustment, and water-cooling output adjustment.

Parameter name	Display	Initial status
Control Output 1 Assignment	$\bar{\alpha}Ut1$	Control output (heating)
Control Output 2 Assignment (E5ED or E5ED-B only)	$\bar{\alpha}Ut2$	Not assigned.
Auxiliary Output 1 Assignment	$Sub1$	Alarm 1* ¹
Auxiliary Output 2 Assignment	$Sub2$	Alarm 2
Auxiliary Output 3 Assignment (E5ED or E5ED-B only)	$Sub3$	Alarm 3
Auxiliary Output 4 Assignment (E5ED or E5ED-B only)	$Sub4$	Alarm 4

*1. If the Digital Controller is equipped with HB/HS alarm detection, it is set by default to detect heater alarms (HA). Therefore, the alarm 1 function is disabled and the Alarm 1 Type is not displayed. To enable alarm 1, set an output assignment to alarm 1. If the Program Pattern parameter is changed to a setting other than OFF, Auxiliary Output 1 Assignment parameter is set as the program end output.

- Refer to page 6-80 and page 6-81 for the functions that can be assigned to the outputs.
- Each output is automatically initialized as shown below by changing the control mode between standard and heating/cooling.

Assigned Output Functions

Two Auxiliary Outputs (E5CD, E5ED, E5CD-B, or E5ED-B)

Parameter name	Display	Allocations	
		Standard	Heating/cooling
Control Output 1 Assignment	oUt 1	Control output (heating)	Control output (heating)
Auxiliary Output 1 Assignment	5Ub 1	Alarm 1 ^{*1}	Alarm 1 ^{*1}
Auxiliary Output 2 Assignment	5Ub 2	Alarm 2	Control output (cooling)

Four Auxiliary Outputs (E5ED or E5ED-B)

Parameter name	Display	Without control output 2		With control output 2	
		Standard	Heating/cooling	Standard	Heating/cooling
Control Output 1 Assignment	oUt 1	Control output (heating)	Control output (heating)	Control output (heating)	Control output (heating)
Control Output 2 Assignment	oUt 2	---	---	Not assigned.	Control output (cooling)
Auxiliary Output 1 Assignment	5Ub 1	Alarm 1 ^{*1}	Alarm 1 ^{*1}	Alarm 1 ^{*1}	Alarm 1 ^{*1}
Auxiliary Output 2 Assignment	5Ub 2	Alarm 2	Alarm 2	Alarm 2	Alarm 2
Auxiliary Output 3 Assignment	5Ub 3	Alarm 3	Alarm 3	Alarm 3	Alarm 3
Auxiliary Output 4 Assignment	5Ub 4	Alarm 4	Control output (cooling)	Alarm 4	Alarm 4

*1. If the Digital Controller is equipped with HB/HS alarm detection, it is set by default to detect heater alarms (HA). Therefore, the alarm 1 function is disabled and the Alarm 1 Type is not displayed. To enable alarm 1, set an output assignment to alarm 1. If the Program Pattern parameter is changed to a setting other than OFF, Auxiliary Output 1 Assignment parameter is set as the program end output.

● Alarms

It will be specified in this section when an alarm must be assigned, i.e., when an alarm must be set for the Control Output 1 or 2 Assignment parameters, or for the Auxiliary Output 1 to 4 Assignment parameters. For example, if alarm 1 is set for the Control Output 1 Assignment parameter, then alarm 1 has been assigned.

Assigning a work bit to either control output 1 or 2 or to auxiliary output 1 to 4 is also considered to be the same as assigning an alarm. For example, if work bit 1 is set for the Auxiliary Output 1 Assignment parameter, then alarms 1 to 4 have been assigned.

Assign the control outputs and auxiliary outputs.

Control output 1: Control output (heating)



Control output 2: Control output (cooling)

Auxiliary output 1: Alarm 1

Auxiliary output 2: Alarm 2

Operating Procedure

- Setting Heating/Cooling Control

<p>1 Press the  Key several times in the Initial Setting Level to display 5-HC (Standard or Heating/Cooling).</p>	<p>Initial Setting Level</p> <div style="border: 1px solid black; padding: 5px; display: inline-block;"> <p>5-HC StNd</p> </div> <p>Standard or Heating/Cooling</p>
<p>2 Press the  or  Key to set the parameter to H-C. The default is StNd (standard).</p>	<div style="border: 1px solid black; padding: 5px; display: inline-block;"> <p>5-HC H-C</p> </div>

* Use the following procedures to check the output assignments. The output assignments are changed automatically when you change between standard and heating/cooling control. You do not have to set them.



- Setting Control Output 1

<p>1 Press the  Key several times in the Advanced Function Setting Level to display out 1 (Control Output 1 Assignment).</p>	<p>Advanced Function Setting Level</p> <div style="border: 1px solid black; padding: 5px; display: inline-block;"> <p>out 1 o</p> </div> <p>Control Output 1 Assignment</p>
<p>2 Set the parameter to o (Control Output (Heating)). The default is o (Control Output (Heating)).</p>	<div style="border: 1px solid black; padding: 5px; display: inline-block;"> <p>out 1 o</p> </div>



- Setting Control Output 2

<p>1 Press the  Key several times in the Advanced Function Setting Level to display out 2 (Control Output 2 Assignment).</p>	<p>Advanced Function Setting Level</p> <div style="border: 1px solid black; padding: 5px; display: inline-block;"> <p>out 2 [-o]</p> </div> <p>Control Output 2 Assignment</p>
<p>2 Set the parameter to [-o] (Control Output (Cooling)). As soon as you select H-C (Heating/Cooling) for the Standard or Heating/Cooling parameter, the setting of this parameter is automatically changed to [-o] (Control Output (Cooling)).</p>	<div style="border: 1px solid black; padding: 5px; display: inline-block;"> <p>out 2 [-o]</p> </div>

- Setting Auxiliary Output 1

<p>1 Press the  Key several times in the Advanced Function Setting Level to display Sub 1 (Auxiliary Output 1 Assignment).</p>	<p>Advanced Function Setting Level</p> <div style="border: 1px solid black; padding: 5px; display: inline-block;"> <p>Sub 1 ALM 1</p> </div> <p>Auxiliary Output 1 Assignment</p>
<p>2 Press the  or  Key to set the parameter to ALM 1. The default is ALM 1 (Alarm 1). If the Digital Controller is equipped with HB/HS alarm detection, this parameter is set by default to HR (heater alarm).</p>	<div style="border: 1px solid black; padding: 5px; display: inline-block;"> <p>Sub 1 ALM 1</p> </div>

- Setting Auxiliary Output 2

<p>1 Press the  Key several times in the Advanced Function Setting Level to display <i>SUb2</i> (Auxiliary Output 2 Assignment).</p>	<p>Advanced Function Setting Level</p> <div style="display: flex; align-items: center;"> <div style="border: 1px solid black; padding: 5px; margin-right: 10px;"> <p style="font-size: 1.2em; margin: 0;"><i>SUb2</i></p> <p style="font-size: 0.8em; margin: 0;"><i>ALM2</i></p> </div> <p style="margin: 0;">Auxiliary Output 2 Assignment</p> </div>
<p>2 Press the  or  Key to set the parameter to <i>ALM2</i>. The default is <i>ALM2</i> (Alarm 2).</p>	<div style="border: 1px solid black; padding: 5px;"> <p style="font-size: 1.2em; margin: 0;"><i>SUb2</i></p> <p style="font-size: 0.8em; margin: 0;"><i>ALM2</i></p> </div>

4-6-4 Auxiliary Output Opening or Closing in Alarm

- When "close in alarm" is set, the status of the auxiliary output is output unchanged. When "open in alarm" is set, the status of the auxiliary output function is reversed before being output.
- Each auxiliary output can be set independently.
- These settings are made in the Auxiliary Output 1 to 4 Open in Alarm parameters (Advanced Function Setting Level).
- The default is $N-\bar{a}$: Close in Alarm.

	Auxiliary output functions 1 to 4	Auxiliary output	Indicators (SUB1 to SUB4)
Close in Alarm ($N-\bar{a}$)	ON	ON	Lit
	OFF	OFF	Not lit
Open in Alarm ($N-\bar{c}$)	ON	OFF	Lit
	OFF	ON	Not lit

- The alarm will turn OFF (i.e., the relay contacts will open) when power is interrupted and for about two seconds after the power is turned ON regardless of the setting of the Auxiliary Output 1 to 4 Open in Alarm parameter.

4-7 Setting the Set Point (SP)

Operation Level



The Operation Level is displayed when the power is turned ON. For the default setting, the No. 1 display shows the PV, the No. 2 display shows the SP, and the No. 3 display (E5ED or E5ED-B only) shows the MV.

The contents that is set in the PV/SP Display Screen Selection parameter in the Advanced Function Setting Level are displayed. For details, refer to 4-13-1 PV/SP Display Selections.

4-7-1 Changing the SP

- The set point cannot be changed when the Operation/Adjustment Protect parameter is set to 3. For details, refer to 5-11 Using the Key Protect Level.
- To change the set point, press the or Key in the PV/SP parameter (Operation Level) or for the SP/SP (character display) display in the Operation Level, and set the desired set value. The new set point is selected three seconds after you have specified the new value.
- Multi-SP can be used to switch between eight set points. For details, refer to 5-8 Using Event Inputs for details.

In this example, the set point is changed from 0°C to 200°C.

Operating Procedure

- 1 Press the or Key in the Operation Level to set the SP to 200°C. The default SP is 0°C. The default SP is 0°C.

Operation Level

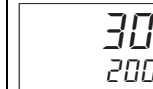

Additional Information

- If there are a lot of digits in a numeric value, you can use the (Shift Key) to select the digit to change before you change the value of the digit.

Example: Changing 1,000°C to 1,200°C

- 1 Press Key three times.
The third digit will flash.

Operation Level



- 2 Press the Key to set the value to 1200.

Operation Level

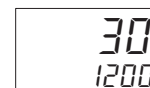

4-8 Using ON/OFF Control

In ON/OFF control, the control output turns OFF when the temperature being controlled reaches the preset set point. When the manipulated variable turns OFF, the temperature begins to fall and the control turns ON again. This operation is repeated over a certain temperature range. At this time, how much the temperature must fall before control turns ON again is determined by the Hysteresis (Heating) parameter. Also, what direction the manipulated variable must be adjusted in response to an increase or decrease in the process value is determined by the Direct/Reverse Operation parameter.

4-8-1 ON/OFF Control

- Switching between 2-PID control and ON/OFF control is performed using the PID ON/OFF parameter in the Initial Setting Level. When this parameter is set to P_{Ld} , 2-PID control is selected, and when it is set to $\bar{a}N\bar{o}F$, ON/OFF control is selected. The default is P_{Ld} .

● Hysteresis

- With ON/OFF control, hysteresis is used to stabilize operation when switching between ON and OFF. The control output (heating) and control output (cooling) functions are set in the Hysteresis (Heating) and Hysteresis (Cooling) parameters, respectively.
- In standard control (heating or cooling control), the setting of the Hysteresis (Heating) parameter in the Adjustment Level is used as the hysteresis regardless of whether the control type is heating control or cooling control.

Reverse operation

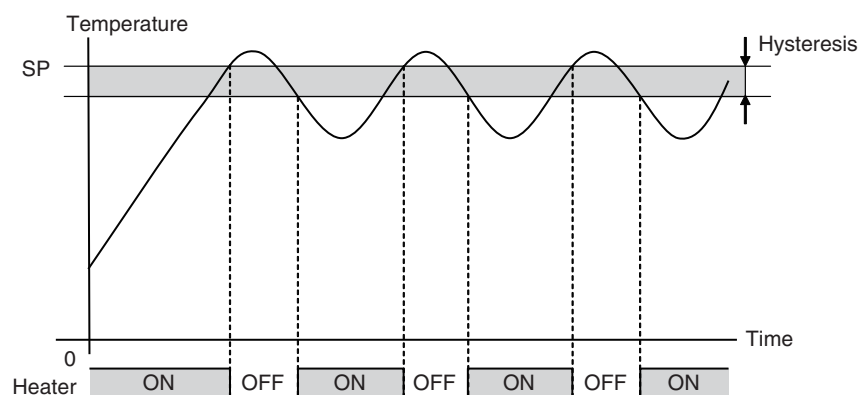

Parameters

Display	Parameter	Application	Level
S-HC	Standard or Heating/Cooling	Specifying control method	Initial Setting Level
ENEL	PID ON/OFF	Specifying control method	Initial Setting Level
REV	Direct/Reverse Operation	Specifying control method	Initial Setting Level
db	Dead Band	Heating/cooling control	Adjustment Level
HYS	Hysteresis (Heating)	ON/OFF control	Adjustment Level
HYS	Hysteresis (Cooling)	ON/OFF control	Adjustment Level



4-8-2 Settings

To execute ON/OFF control, set the Set Point, PID ON/OFF, and Hysteresis parameters.

Setting the PID ON/OFF Parameter

Confirm that the PID ON/OFF parameter is set to $\bar{a}N\bar{o}F$ in the Initial Setting Level.

Operating Procedure

<p>1 Press the ☐ Key several times in the Initial Setting Level to display ENEL (PID ON/OFF). The default is $P\bar{c}d$ (PID control).</p>	<p>Initial Setting Level</p>  <p>PID ON/OFF</p>
<p>2 Press the ▲ or ▼ Key to set $\bar{a}N\bar{o}F$ (ON/OFF control).</p>	

Setting the SP

In this example, the set point is set to 200°C. The set value (i.e., the SP) is shown at the bottom of the display.



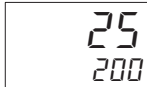

Operating Procedure

<p>1 Select PV/SP in the Operation Level.</p>	<p>Operation Level</p>  <p>PV/SP</p>
<p>2 Press the ▲ or ▼ Key to set the SP to 200. The default is 0. The new set value can be saved by pressing the ☐ Key, or it will go into effect after 3 seconds has elapsed.</p>	

Setting the Hysteresis

Set the heating hysteresis to 2.0°C.

Operating Procedure

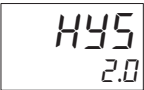
<p>1 Press the  Key several times in the Adjustment Level to display <i>HYS</i> (Hysteresis (Heating)).</p>	<p>Adjustment Level</p>  <p>Hysteresis (Heating)</p>
<p>2 Press the  or  Key to set the hysteresis to 2.0. The default is 1.0. The new set value can be saved by pressing the  Key, or it will go into effect after 3 seconds has elapsed.</p>	

4-9 Determining PID Constants (AT, Manual Setup)

4-9-1 AT (Auto-tuning)

AT

- When AT is executed, the optimum PID constants for the set point at that time are set automatically. A method (called the limit cycle method) for forcibly changing the manipulated variable and finding the characteristics of the control object is employed.
- Either 40% AT or 100% AT can be selected depending on the width of MV variation in the limit cycle. In the AT Execute/Cancel parameter, specify $AT - 2$ (100% AT) or $AT - 1$ (40% AT). To cancel AT, specify OFF (AT cancel).
- Only 100% AT can be executed for heating and cooling control.
- If the Heating/Cooling Tuning Method parameter is set to any value other than 0 (same as heating control), the PID constants are set automatically for both heating control and cooling control.
- AT cannot be executed when control has stopped or during ON/OFF control.
- The results of autotuning are saved in the following parameters in the Adjustment Level: Proportional Band (P), Integral Time (I), Derivative Time (D), Proportional Band (Cooling) (C-P), Integral Time (Cooling) (C-I), and Derivative Time (Cooling) (C-D). If the Adaptive Control parameter (ADP) in the Initial Setting Level is set for automatic updating ($UPDATE$) or notification ($NOTIFY$), the change will be reflected in set point response PID, disturbance PID, and model parameters that give the system characteristics. (*For information on adaptive control, refer to 5-3 *Performing Adaptive Control*.)

PID Constants Updated for 2-PID Control
Adjustment Level

P
8.0

Proportional
Band

C-P
8.0

Proportional
Band (Cooling)

I
233

Integral
Time

C-I
233

Integral Time
(Cooling)

d
40

Derivative
Time

C-D
40

Derivative Time
(Cooling)

Model Parameters and PID Constants Updated for Adaptive Control Adjustment Level

$SP-P$ 8.0	SP Response Proportional Band	$d-P$ 8.0	Disturbance Proportional Band
$SP-I$ 233	SP Response Integral Time	$d-I$ 233	Disturbance Integral Time
$SP-d$ 40	SP Response Derivative Time	$d-d$ 40	Disturbance Derivative Time

Initial Setting Level

$M-PV$ 0.0	Model Creation PV Amplitude	$M-ON$ 0	Model Creation ON Time
$M-MV$ 0.0	Model Creation MV Amplitude	$M-OFF$ 0	Model Creation OFF Time

● AT Operations

AT is started when either $RL-2$ (100% AT) or $RL-1$ (40% AT) is specified for the AT Execute/Cancel parameter.

The **TUNE** indicator will light during execution.

Only the Communications Writing, RUN/STOP, AT Execution/Cancel, and Program Start parameters can be changed during AT execution. Other parameters cannot be changed.

● AT Calculated Gain **MASK8**

Sets the gain used when calculating the PID constants in autotuning. When emphasizing rapid response, decrease the set value. When emphasizing stability, increase the set value.

● AT Hysteresis **MASK8**

The AT Hysteresis parameter sets the hysteresis when switching ON and OFF for the limit cycle operation during auto-tuning.

● Limit Cycle MV Amplitude **MASK8**

The Limit Cycle MV Amplitude parameter sets the MV amplitude for limit cycle operation during auto-tuning.

* This setting is disabled for 100% AT.

40% AT

- The width of MV variation in the limit cycle can be changed in the Limit Cycle MV Amplitude parameter, but the AT execution time may be longer than for 100% AT. The limit cycle timing varies according to whether the deviation (DV) at the start of auto-tuning execution is less than 10% FS.

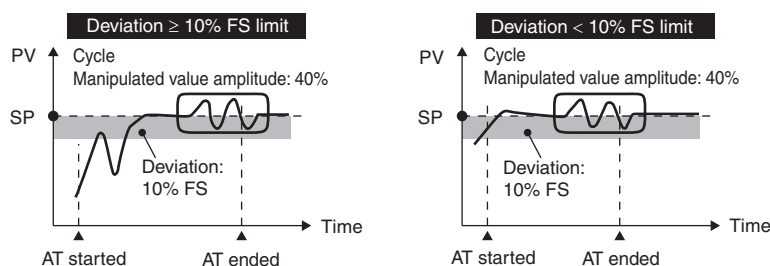

100% AT

- Operation will be as shown in the following diagram, regardless of the deviation (DV) at the start of AT execution. To shorten the AT execution time, select 100% AT.

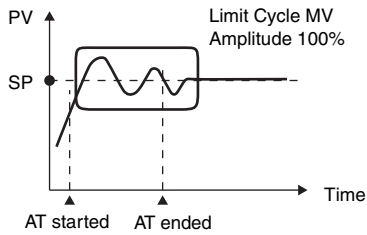

* The Limit Cycle MV Amplitude parameter is disabled.

The 100% autotuning is executed.

Operating Procedure

<p>1 Press the Key several times in the Adjustment Level to display AL (AT Execute/Cancel).</p>	<p>Adjustment Level</p> <div style="border: 1px solid black; padding: 5px; display: inline-block;"> <p>AL OFF</p> </div> <p>AT Execute/Cancel</p>
<p>2 Press the or Key to select AL-2 (100% AT execute).</p> <p>* The TUNE indicator will light during autotuning.</p>	<div style="border: 1px solid black; padding: 5px; display: inline-block;"> <p>AL AL-2</p> </div>
<p>3 When AT ends, the AT Execute/Cancel parameter is set to OFF.</p>	<p>Adjustment Level</p> <div style="border: 1px solid black; padding: 5px; display: inline-block;"> <p>AL OFF</p> </div> <p>AT Execute/Cancel</p>



Precautions for Correct Use

To execute autotuning, you must set the RUN/STOP parameter to RUN (default: RUN) and the PID ON/OFF parameter to PID (default: PID). If the RUN/STOP parameter is set to STOP or the PID ON/OFF parameter is set to ON/OFF, the settings for the AT Execute/Cancel parameter will not be displayed.

Supplemental Information on AT Operation

- Perform AT with the control set point set and the power supply to the output side (e.g., heater) turned ON.
- You can start AT from any current temperature.



Additional Information

• PID Constants

When control characteristics are already known, PID constants can be set directly to adjust control. The PID constants are set in the following parameters in the Adjustment Level: Proportional Band (P), Integral Time (I), Derivative Time (D), Proportional Band (Cooling) (C-P), Integral Time (Cooling) (C-I), and Derivative Time (Cooling) (C-D).

• Integral/Derivative Time Unit

If the results of executing AT give a derivative time (D) of less than 10 seconds, we recommend that you set the Integral/Derivative Time Unit parameter (Advanced Setting Level) to 0.1 seconds and perform AT again.

4-9-2 RT (Robust Tuning) (Use with AT) MASK8

RT

- When AT is executed with RT selected, PID constants are automatically set that make it hard for control performance to deteriorate even when the characteristics of the controlled object are changed.
- RT can be set in the Advanced Function Setting Level when PID control has been set.
- The RT mode cannot be selected while an analog input is set.
- Selecting the RT mode in the following cases will help to prevent hunting from occurring.
 - When the set temperature is not constant and is changed in a wide range
 - When there are large variations in ambient temperatures due to factors such as seasonal changes or differences between day and night temperatures
 - When there are large variations in ambient wind conditions and air flow
 - When heater characteristics change depending on the temperature
 - When an actuator with disproportional I/O, such as a phase-control-type power regulator, is used
 - When a rapidly heating heater is used
 - When the control object or sensor has much loss time
 - When hunting occurs in normal mode for any reason
 - * PID constants are initialized to the factory settings by switching to RT mode.
 - * When the RT mode is selected, the Integral/Derivative Time Unit parameter changes to 0.1 s.

● **RT Features**

- Even when hunting occurs for PID constants when AT is executed in normal mode, it is less likely to occur when AT is executed in RT Mode.

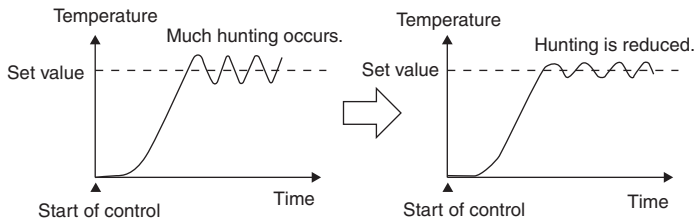

- When the temperature (PV) falls short of the set point for the PID constants when using AT in normal mode, executing AT in RT Mode tends to improve performance.

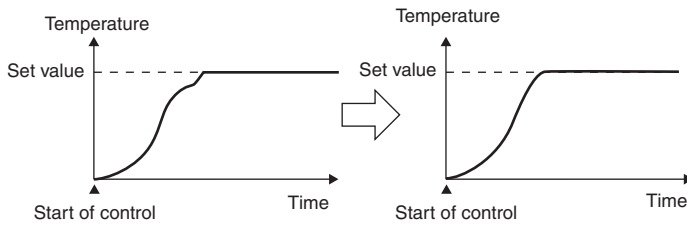

- When the manipulated variable (MV) is saturated, the amount of overshooting may be somewhat higher in comparison to PID control based on AT in normal mode.

This procedure selects RT mode.

Operating Procedure

<p>1 Press the Key several times in the Advanced Function Setting Level to display <i>RT</i> (RT: robust tuning).</p>	<p>Advanced Function Setting Level</p> <div style="border: 1px solid black; padding: 5px; display: inline-block;"> <p><i>RT</i> RT <i>OFF</i> MASK8</p> </div>
<p>2 Press the or Key to select <i>ON</i> (RT ON). The default is <i>OFF</i>.</p>	<div style="border: 1px solid black; padding: 5px; display: inline-block;"> <p><i>RT</i> <i>ON</i> MASK8</p> </div>





4-9-3 Manual Setup

Individual PID constants can be manually set in the Proportional Band, Integral Time, and Derivative Time parameters in the Adjustment Level.

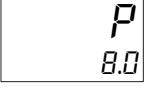

In this example, the Proportional Band parameter is set to 10.0, the Integral Time parameter to 250, and the Derivative Time parameter to 45.

Operating Procedure

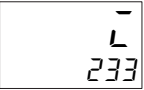

- Setting the Proportional Band

<p>1 Press the  Key several times in the Adjustment Level to display the <i>P</i> (Proportional Band) parameter.</p>	<p>Adjustment Level</p>  Proportional Band
<p>2 Press the  or  Key to set the value to 10.0. The default settings are as follows:</p> <ul style="list-style-type: none"> Temperature input (°C or °F): 8.0 Analog input (%FS): 10.0 	

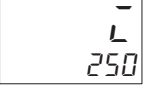
- Setting the Integral Time

<p>1 Press the  Key several times in the Adjustment Level to display the <i>I</i> (Integral Time) parameter.</p>	<p>Adjustment Level</p>  Integral Time
<p>2 Press the  or  Key to set the value to 250. The default settings are as follows:</p> <ul style="list-style-type: none"> Integral/Derivative Time Unit of 1 s: 233 Integral/Derivative Time Unit of 0.1 s: 233.0 	

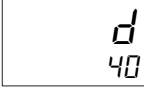
- Setting the Derivative Time

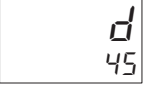
<p>1 Press the  Key several times in the Adjustment Level to display the <i>d</i> (Derivative Time) parameter.</p>	<p>Adjustment Level</p>  Derivative Time
<p>2 Press the  or  Key to set the value to 45. The default settings are as follows:</p> <ul style="list-style-type: none"> Integral/Derivative Time Unit of 1 s: 40 Integral/Derivative Time Unit of 0.1 s: 40.0 	



Additional Information

- Proportional Action
When PID constants I (integral time) and D (derivative time) are set to 0, control is executed according to proportional action. As the default, the center value of the proportional band becomes the set point.
* Related parameter: Manual Reset Value (Adjustment Level)
- Integral/Derivative Time Unit
If the results of executing AT give a derivative time (D) of less than 10 seconds, we recommend that you set the Integral/Derivative Time Unit parameter (Advanced Setting Level) to 0.1 seconds and perform AT again.

When P (Proportional Band) Is Adjusted

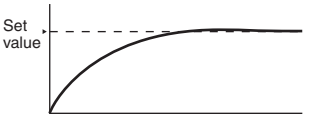
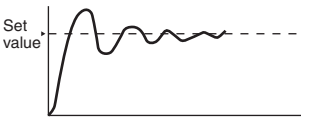
Increased	 <p>The graph shows a smooth curve starting from the origin and rising to a horizontal dashed line labeled 'Set value'. The curve has a concave-down shape, indicating a gradual rise and long stabilization time.</p>	The curve rises gradually, and a long stabilization time is created, but overshooting is prevented.
Decreased	 <p>The graph shows a curve that rises quickly, overshoots the 'Set value' line, and then oscillates around it with decreasing amplitude before stabilizing.</p>	Overshooting and hunting occur, but the set value is quickly reached and the temperature stabilizes.

When I (Integral Time) Is Adjusted

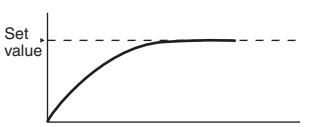
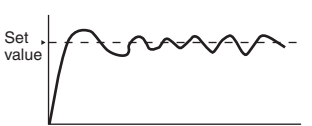
Increased	 <p>The graph shows a smooth curve starting from the origin and rising to a horizontal dashed line labeled 'Set value'. The curve has a concave-down shape, indicating a gradual rise and long stabilization time.</p>	It takes a long time to reach the set point. It takes time to achieve a stable state, but overshooting, undershooting, and hunting are reduced.
Decreased	 <p>The graph shows a curve that rises quickly, overshoots the 'Set value' line, and then oscillates around it with decreasing amplitude before stabilizing.</p>	Overshooting and undershooting occur. Hunting occurs. The Digital Controller starts up faster.

When D (Derivative Time) Is Adjusted

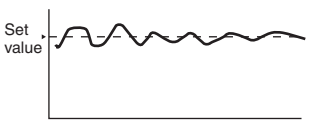
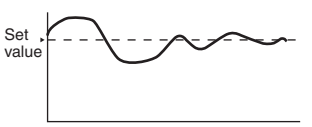
Increased	 <p>The graph shows a curve that rises quickly, overshoots the 'Set value' line, and then oscillates around it with decreasing amplitude before stabilizing.</p>	Overshooting, undershooting, and stabilization times are reduced, but fine hunting occurs on changes in the curve itself.
Decreased	 <p>The graph shows a curve that rises quickly, overshoots the 'Set value' line, and then oscillates around it with decreasing amplitude before stabilizing.</p>	Overshooting and undershooting increase, and it takes time to return to the set point.

4-10 Alarm Outputs

- Alarms are output from auxiliary outputs. For relay outputs or voltage outputs (for driving SSRs), alarms can also be used by setting the Control Output 1 Assignment or Control Output 2 Assignment parameter to any of the alarms from alarm 1 to 4. The alarm output condition is determined by a combination of the alarm type, alarm value, alarm hysteresis, and the standby sequence. For details, refer to *4-11 Alarm Hysteresis*.
- This section describes the Alarm Type, Alarm Value, Upper-limit Alarm and Lower-limit Alarm parameters.

4-10-1 Alarm Types

AL1 Alarm 1 Type

AL2 Alarm 2 Type

AL3 Alarm 3 Type

AL4 Alarm 4 Type

- Set the alarm type independently for each alarm in the Alarm 1 to 4 Type parameters in the Initial Setting Level.
- The alarms that can be set are listed in the following table.
- You can use an LBA (12) only for alarm 1.
- If the Controller is equipped with HB/HS alarm detection, the default setting for the Auxiliary Output 1 Assignment is for heater alarms. Therefore, the alarm 1 function is disabled and the Alarm 1 Type is not displayed. To use alarm 1, set an output assignment to alarm 1. (Refer to *4-6-3 Assigned Output Functions* on page 4-16.)

Set value	Alarm type	Alarm output operation		Description of function
		When alarm value X is positive	When alarm value X is negative	
0	Alarm function OFF	Output OFF		No alarm
1	Upper- and lower-limit*1		*2	Set the upward deviation in the set point for the alarm upper limit (H) and the lower deviation in the set point for the alarm lower limit (L). The alarm is ON when the PV is outside this deviation range.
2 (default)	Upper-limit			Set the upward deviation in the set point by setting the alarm value (X). The alarm is ON when the PV is higher than the SP by the deviation or more.
3	Lower-limit			Set the downward deviation in the set point by setting the alarm value (X). The alarm is ON when the PV is lower than the SP by the deviation or more.

Set value	Alarm type	Alarm output operation		Description of function
		When alarm value X is positive	When alarm value X is negative	
4	Upper- and lower-limit range*1		*3	Set the upward deviation in the set point for the alarm upper limit (H) and the lower deviation in the set point for the alarm lower limit (L). The alarm is ON when the PV is inside this deviation range.
5	Upper- and lower-limit with standby sequence*1		*4	A standby sequence is added to the upper- and lower-limit alarm (1).*6
6	Upper-limit with standby sequence			A standby sequence is added to the upper-limit alarm (2).*6
7	Lower-limit with standby sequence			A standby sequence is added to the lower-limit alarm (3).*6
8	Absolute-value upper-limit			The alarm will turn ON if the process value is larger than the alarm value (X) regardless of the set point.
9	Absolute-value lower-limit			The alarm will turn ON if the process value is smaller than the alarm value (X) regardless of the set point.
10	Absolute-value upper-limit with standby sequence			A standby sequence is added to the absolute-value upper-limit alarm (8).*6
11	Absolute-value lower-limit with standby sequence			A standby sequence is added to the absolute-value lower-limit alarm (9).*6
12	LBA (alarm 1 type only)	/		*7
13	PV change rate alarm	/		*8
14	SP absolute-value upper-limit alarm			This alarm type turns ON the alarm when the set point (SP) is higher than the alarm value (X).
15	SP absolute-value lower-limit alarm			This alarm type turns ON the alarm when the set point (SP) is lower than the alarm value (X).
16	MV absolute-value upper-limit alarm*9	Standard Control		This alarm type turns ON the alarm when the manipulated variable (MV) is higher than the alarm value (X).
		Heating/Cooling Control (Heating MV)		
		Heating/Cooling Control (Cooling MV)	Always ON	

Set value	Alarm type	Alarm output operation		Description of function
		When alarm value X is positive	When alarm value X is negative	
17	MV absolute-value lower-limit alarm*9	Standard Control 	Standard Control 	This alarm type turns ON the alarm when the manipulated variable (MV) is lower than the alarm value (X).
		Heating/Cooling Control (Cooling MV) 	Heating/Cooling Control (Cooling MV) Always ON	

- *1 With set values 1, 4, and 5, the upper- and lower-limit values can be set independently for each alarm type, and are expressed as “L” and “H.”
- *2 Set value: 1 (Upper- and lower-limit alarm)

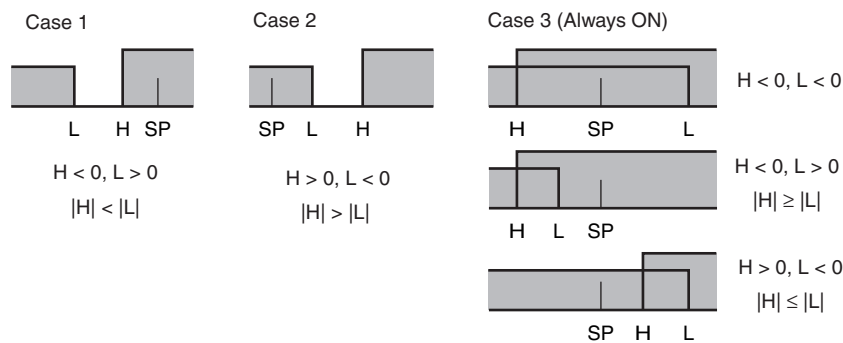

- *3 Set value: 4 (Upper- and lower-limit range)

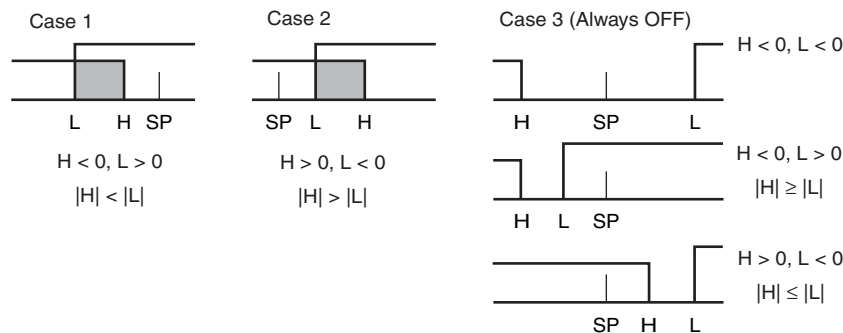

- *4 Set value: 5 (Upper- and lower-limit alarm with standby sequence)
 - For the upper- and lower-limit alarms in cases 1 and 2 above, the alarm is always OFF if upper- and lower-limit hysteresis overlaps.
 - In case 3, the alarm is always OFF.
- *5 Set value: 5 (Upper- and lower-limit alarm with standby sequence)
 - The alarm is always OFF if upper- and lower-limit hysteresis overlaps.
- *6 Refer to *Standby Sequence Reset* on page 6-65 for information on the operation of the standby sequence.
- *7 Refer to *5-15-1 Loop Burnout Alarm (LBA)*.
- *8 Refer to *PV Change Rate Alarm* on page 4-35.
- *9 When heating/cooling control is performed, the MV absolute-value upper-limit alarm functions only for the heating operation and the MV absolute-value lower-limit alarm functions only for the cooling operation.

4-10-2 Alarm Values

 Alarm Lower Limit Value

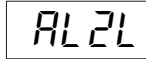



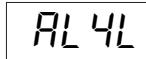

 Alarm Upper Limit Value

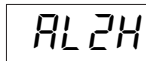

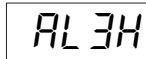

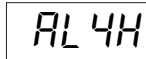

 Alarm Value

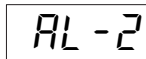

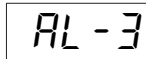

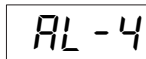



- Alarm values are indicated by “X” in the table on the previous page. When the upper and lower limits are set independently, “H” is displayed for upper limit values, and “L” is displayed for lower limit values.
- To set the alarm value upper and lower limits for deviation, set the upper and lower limits in each of the Alarm 1 to 4 Upper Limit, and Alarm 1 to 4 Lower Limit parameters in the Operation Level.

This procedure sets alarm 1 as an upper-limit alarm. The alarm is output when the process value (PV) exceeds the set point (SP) by 10°C. (In this example, the temperature unit is °C.)

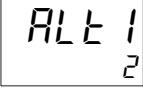

This procedure sets the Alarm 1 Type parameter to 2 (upper alarm) and the Alarm 1 parameter to 10.

Operating Procedure

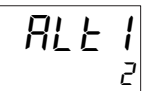
- Selecting the Alarm 1 Type

<p>1 Press the  Key several times in the Initial Setting Level to display <i>AL 1</i> (Alarm 1 Type).*</p>	<p>Initial Setting Level</p>  Alarm 1 Type
<p>2 Press the  or  Key to set the set value to 2. The default is 2 (upper-limit alarm).</p>	

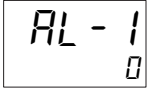
- Setting the Alarm Value

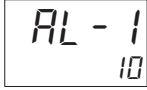
<p>1 Press the  Key several times in the Operation Level to display <i>AL - 1</i> (Alarm Value 1).</p>	<p>Operation Level</p>  Alarm Value 1
<p>2 Press the  or  Key to set the set value to 10. The default is 10.</p>	

* If the Controller is equipped with HB/HS alarm detection, the default setting for the Auxiliary Output 1 Assignment is for heater alarms. Therefore, the alarm 1 function is disabled and the Alarm 1 Type is not displayed. To enable alarm 1, set an output assignment to alarm 1. For details, refer to 4-6-3 Assigned Output Functions on page 4-16.

● **PV Change Rate Alarm**

The change width can be found for PV input values in any set period. Differences with previous values in each set period are calculated, and an alarm is output if the result exceeds the alarm value. The PV rate of change calculation period can be set in units of 50 ms.

If a positive value is set for the alarm value, the PV will operate as a change rate alarm in the rising direction. If a negative value is set, the PV will operate as a change rate alarm in the falling direction.

 **Precautions for Correct Use**

If a shorter PV rate of change calculation period is set, outputs set for the PV change rate alarm function may repeatedly turn ON and OFF for a short period of time. It is therefore recommended that the PV change rate alarm be used with the alarm latch turned ON.

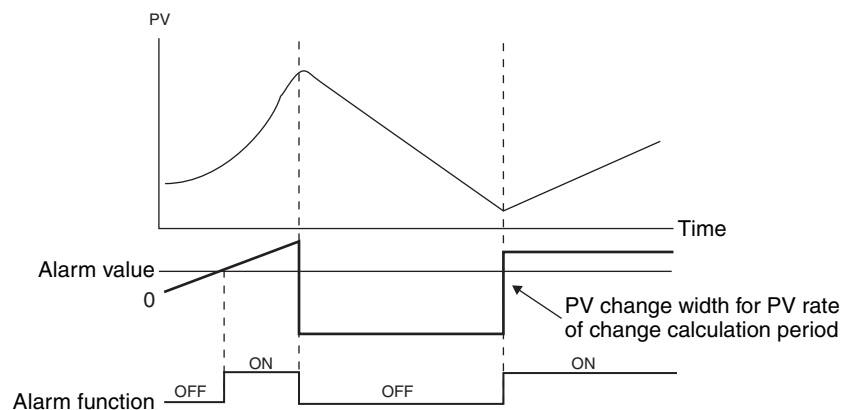

Parameter name	Setting range	Unit	Default
PV Rate of Change Calculation Period	1 to 999	Sampling cycle	20 (1 s)

● **SP Alarms**

You can set an SP absolute-value upper-limit or SP absolute-value lower-limit alarm for the set point (SP).

The alarm point is set in the corresponding alarm value parameter. The Alarm SP Selection parameter is used to specify the alarm for either the ramp SP or the target SP.

The corresponding alarm hysteresis setting is also valid.

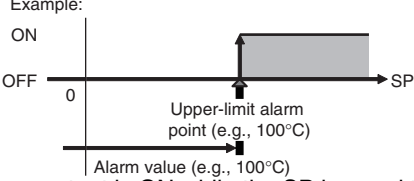
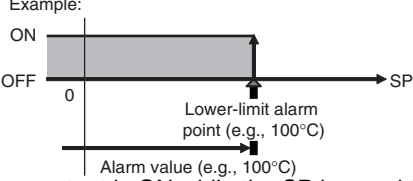
SP absolute-value upper-limit alarm	SP absolute-value lower-limit alarm
<p>Example:</p>  <p>The alarm output is ON while the SP is equal to or higher than the set value.</p>	<p>Example:</p>  <p>The alarm output is ON while the SP is equal to or lower than the set value.</p>

● **MV Alarms**

You can set an MV absolute-value upper-limit or MV absolute-value lower-limit alarm for the manipulated value (MV).

The alarm point is set in the corresponding alarm value parameter. The corresponding alarm hysteresis setting is also valid.

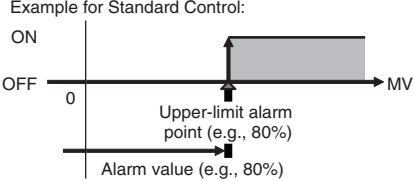
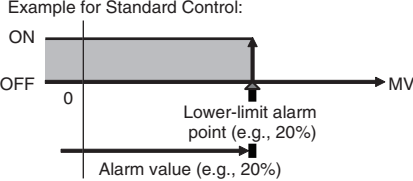
MV absolute-value upper-limit alarm	MV absolute-value lower-limit alarm
<p>Example for Standard Control:</p>  <p>The alarm output is ON while the MV is equal to or higher than the set value.</p>	<p>Example for Standard Control:</p>  <p>The alarm output is ON while the MV is equal to or lower than the set value.</p>

4-11-2 Alarm Latch

- The alarm latch can be used to keep the alarm output ON until the latch is canceled regardless of the temperature once the alarm output has turned ON.

Any of the following methods can be used to clear the alarm latch.

- Turn OFF the power supply. (The alarm latch is also cleared by switching to the Initial Setting Level, Communications Setting Level, Advanced Function Setting Level, or Calibration Level.)
- Use the PF Key.
- Use an event input.

For details on setting the PF Key, refer to 5-21 *Setting the PF Key*. For details on setting events, refer to 5-8 *Using Event Inputs*.

● Summary of Alarm Operation

The following figure summarizes the operation of alarms when the Alarm Type parameter is set to "lower-limit alarm with standby sequence" and "close in alarm" is set.

Alarm type: Lower-limit alarm with standby sequence

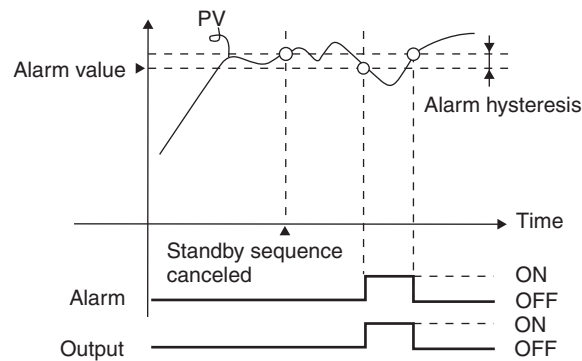

Parameters

Display	Parameter	Description	Level
<i>RLH*</i>	Alarm 1 to 4 Hysteresis	Alarm	Initial Setting Level
<i>RESET</i>	Standby Sequence	Alarm	Advanced Function Setting Level

* * = 1 to 4

4-12 Using Heater Burnout (HB) and Heater Short (HS) Alarms

These functions are supported for models that detect heater burnout (HB) and heater short (HS) alarms.

4-12-1 HB Alarm

● What Is an HB Alarm?

An HB alarm is detected by measuring the heater current with a current transformer (CT) when the control output is ON. If the measured heater current is lower than the setting of the Heater Burnout Detection Current parameter, an alarm is output.

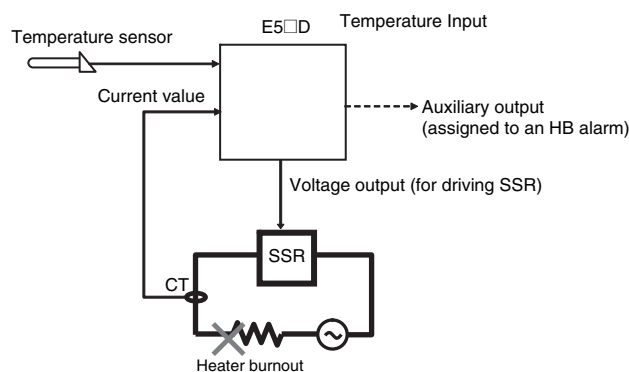

- This alarm cannot be used for the cooling control output.
- The default setting for the Auxiliary Output 1 Assignment is for heater alarms. Therefore, the alarm 1 function is disabled and the Alarm 1 Type is not displayed. You can use the output assignment parameters to change the alarm output location. For details, refer to *4-6-3 Assigned Output Functions* on page 4-16.
- You can use an integrated alarm to output an OR of alarms 1 to 4 and the other alarms. For details on the integrated alarm, refer to *5-13 OR Output of Alarms* on page 5-49.

● Parameters

Parameter	No. 1 display	Value	No. 2 display	Level
HB ON/OFF	<i>HbU</i>	OFF or ON (default: ON)	<i>āFF, āN</i>	Advanced Function Setting Level
Heater Burnout Latch	<i>HbL</i>	OFF or ON (default: OFF)	<i>āFF, āN</i>	Advanced Function Setting Level
Heater Burnout Hysteresis	<i>HbH</i>	0.1 to 50.0 A (default: 0.1 A)	0.1 to 50.0	
Heater Burnout Detection 1 or 2 (alarm current)	<i>Hb1</i>	0.0 to 50.0 A (default: 0.0 A)	0.0 to 50.0	Adjustment Level
Heater Current 1 or 2 Value Monitor	<i>Et1</i> <i>Et2</i>	0.0 to 55.0 A	0.0 to 55.0	Advanced Function Setting Level
Auxiliary Output 1 to 4 Assignment	<i>SUb1</i> to <i>SUb4</i>	HB: HB alarm or HA: Heater alarm	<i>Hb</i> or <i>HA</i>	

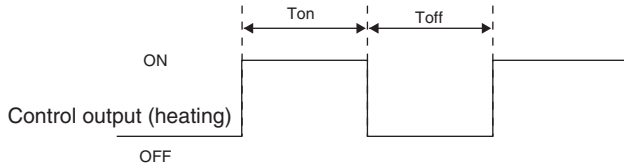

In the above diagram, power is considered to be ON (normal) if the heater current is greater than $H_b I$ (Heater Burnout Detection Current) during the T_{on} interval. The HB alarm will be OFF in this case. If the heater current is less than $H_b I$ (Heater Burnout Detection Current) during the T_{on} interval, the HB alarm will turn ON. Heater burnout is not detected if the ON time (T_{on}) for the control output for heating is 100 ms or less (30 ms or less if the control period is 0.1 or 0.2 s).

Heater burnouts are not detected in the following cases.

- Turn ON the heater power supply simultaneously or before turning ON the E5□D power supply. If the heater power supply is turned ON after turning ON the E5□D power supply, the HB alarm will be output.
- Control will be continued even when there is an HB alarm.
- The rated current may sometimes differ slightly from the actual current flowing to the heater. Check the current value in an actual operating state in the Heater Current Value 1 Monitor parameter.
- If there is little difference between the current in normal and abnormal states, detection may be unstable. To stabilize detection, set a current difference of at least 1.0 A for heaters lower than 10.0 A, and at least 2.5 A for heaters of 10.0 A or higher. If the heater current is too low, loop the load line several times through a CT, as shown in the following diagram. Looping it through once will double the detected current.

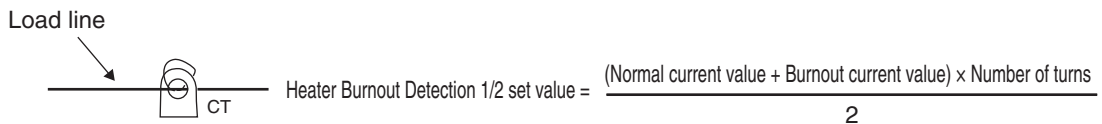

Precautions for Correct Use

Due to UL Listing requirements, use the E54-CT1L or E54-CT3L Current Transformer with the factory wiring (internal wiring). Use a UL category XOBA or XOBA7 current transformer that is UL Listed for field wiring (external wiring) and not the factory wiring (internal wiring).

● Operating Procedure

Set the HB ON/OFF parameter in the Advanced Function Setting Level, and set the Heater Burnout Detection 1 parameter in the Adjustment Level.







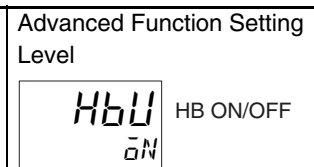

Heater Burnout Detection 1 = 2.5

Operating Procedure

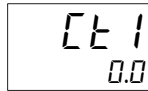
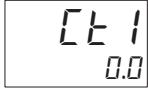
- Checking the HB ON/OFF Parameter Setting

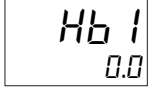
1 Press the **Ⓢ** Key several times in the Advanced Function Setting Level to display $H_b I$ (HB ON/OFF).



<p>2 Check to see if the set value is $\bar{a}N$ (enabled, default).</p>	
<p>• Checking the Heater Current</p>	
<p>1 Press the  Key several times in the Adjustment Level to display $CT1$ (Heater Current 1 Value Monitor).</p>	<p>Adjustment Level</p>  <p>Heater Current 1 Value Monitor</p>
<p>2 Check the heater current from the CT input that is used to detect heater burnout. The monitoring range is 0.0 to 55.0 A.</p>	
<p>• Setting Heater Burnout Detection</p>	
<p>1 Press the  Key several times in the Adjustment Level to display $Hb1$ (Heater Burnout Detection 1).</p>	<p>Adjustment Level</p>  <p>Heater Burnout Detection 1</p>
<p>2 Press the  or  Key to set the set value to 2.5 Refer to 4-12-4 Calculating Detection Current Values when you set the value.</p>	

4-12-2 HS Alarm

● What Is an HS Alarm?

An HS alarm is detected by measuring the heater current with a current transformer (CT) when the control output is OFF. If the measured heater current is higher than the setting of the HS Alarm parameter, an alarm is output.

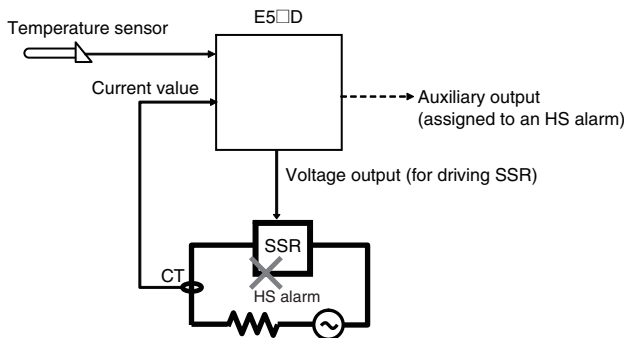

Control output (heating)	Power to heater	HS alarm output
OFF	Yes (HS alarm)	ON
	No (normal)	OFF

This alarm cannot be used for the cooling control output. With the default settings, the HS alarm is output on auxiliary output 1. You can use the output assignment parameters to change the output. You can use an integrated alarm to output an OR of alarms 1 to 4 and the other alarms. For details on the integrated alarm, refer to 5-13 OR Output of Alarms.

● Parameters

Parameter	No. 1 display	Value	No. 2 display	Level
HS Alarm Use	<i>HSU</i>	OFF or ON (default: ON)	$\bar{0}FF, \bar{0}N$	Advanced Function Setting Level
HS Alarm Latch	<i>HSL</i>	OFF or ON (default: OFF)	$\bar{0}FF, \bar{0}N$	
HS Alarm Hysteresis	<i>HSH</i>	0.1 to 50.0 A (default: 0.1 A)	0.1 to 50.0	
HS Alarm 1 (alarm current)	<i>HS I</i>	0.0 to 50.0 A (default: 50.0 A)	0.0 to 50.0	Adjustment Level
Leakage Current 1 Monitor	<i>LER I</i>	0.0 to 55.0 A	0.0 to 55.0	
Auxiliary Output 1 to 4 Assignment	<i>SUb 1 to SUB4</i>	HS: HS alarm or HA: Heater alarm	<i>HS</i> or <i>HR</i>	Advanced Function Setting Level

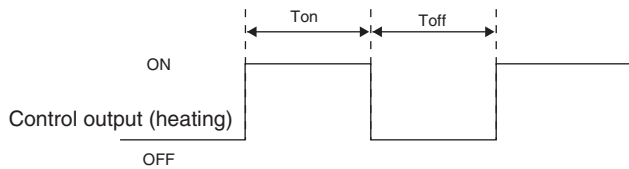

In the above diagram, power is considered to be OFF (normal) if the leakage current is less than *HS I* (Heater Short Detection Current) during the *Toff* interval. The HS alarm will be OFF in this case. If the leakage current is greater than *HS I* (Heater Short Detection Current) during the *Toff* interval, the HS alarm will turn ON. Heater shorts are not detected if the OFF time (*Toff*) for the control output for heating is 100 ms or less (38 ms or less if the control period is 0.1 or 0.2 s). Heater shorts are not detected in the following cases.

- Control will be continued even when there is an HS alarm.
- The rated current may sometimes differ slightly from the actual current flowing to the heater. Check the current value in an actual operating state in the Leakage Current Value 1 Monitor parameter.



Set the HS Alarm Use parameter to ON in the Advanced Function Setting Level and set the HS Alarm 1 parameter in the Adjustment Level. This procedure sets the HS Alarm 1 parameter to 2.5.

Operating Procedure

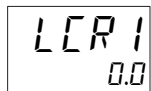

- Setting the HS Alarm Use Parameter

<p>1 Press the Ⓢ Key several times in the Advanced Function Setting Level to display <i>HSU</i> (HS Alarm Use).</p>	<p>Advanced Function Setting Level</p> <div style="border: 1px solid black; padding: 5px; display: inline-block;"> <p><i>HSU</i> $\bar{0}N$</p> </div> <p>HS Alarm Use</p>
<p>2 Check to see if the set value is $\bar{0}N$ (enabled, default).</p>	<div style="border: 1px solid black; padding: 5px; display: inline-block;"> <p><i>HSU</i> $\bar{0}N$</p> </div>

- Setting the Leakage Current Value Monitor

<p>1 Press the  Key several times in the Adjustment Level to display LCR 1 (Leakage Current 1 Value Monitor).</p>	<p>Adjustment Level</p>  <p>Leakage Current 1 Value Monitor</p>
<p>2 Check the leakage current from the CT input that is used to detect heater short. The monitoring range is 0.0 to 55.0 A.</p>	

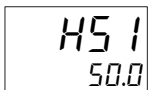
- Setting Heater Short Alarm Detection

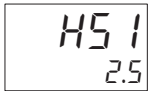
<p>1 Press the  Key several times in the Adjustment Level to display HS 1 (HS Alarm 1).</p>	<p>Adjustment Level</p>  <p>HS Alarm 1</p>
<p>2 Press the  or  Key to set the set value to 2.5 Refer to 4-12-4 Calculating Detection Current Values when you set the value.</p>	

- If there is little difference between the current in normal and abnormal states, detection may be unstable. To stabilize detection, set a current difference of at least 1.0 A for heaters lower than 10.0 A, and at least 2.5 A for heaters of 10.0 A or higher. If the heater current is too low, loop the load line several times through a CT, as shown in the following diagram. Looping it through once will double the detected current.

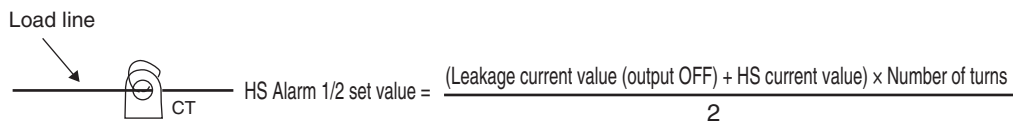

Precautions for Correct Use

Due to UL Listing requirements, use the E54-CT1L or E54-CT3L Current Transformer with the factory wiring (internal wiring). Use a UL category XOBA or XOBA7 current transformer that is UL Listed for field wiring (external wiring) and not the factory wiring (internal wiring).

4-12-3 Installing Current Transformers (CT)

- CTs can be used for the heater burnout (HB) and heater short (HS) alarms.
For the E5CD, connect the CT in advance to terminals 16 and 17 (CT1). For the E5CD-B, connect the CT in advance to terminals 21 and 22 (CT1). For the E5ED, connect the CT in advance to terminals 19 and 20 (CT1). For the E5ED-B, connect the CT in advance to terminals 25 and 26 (CT1). Then pass the heater power line through the hole in the CT. For specifications, models, and dimensions of the CTs that can be used with the Digital Controller, refer to A-2 Current Transformer (CT).

Install the CT in the position shown in the following diagram.

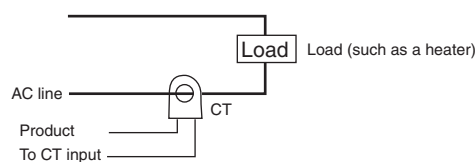

4-12-4 Calculating Detection Current Values

Calculate the set value using the following equation:

$$\text{Heater Burnout Detection 1 set value} = \frac{\text{Normal current value} + \text{Burnout current value}}{2}$$

$$\text{HS Alarm 1 set value} = \frac{\text{Leakage current value (output OFF)} + \text{HS current value}}{2}$$

- To set the current for heater burnout when two or more heaters are connected through the CT, use the value from when the heater with the smallest current burns out. If all of the heaters have the same current, use the value from when any one of them burns out.

Example: Heater Burnout Detection 1 set value = $\frac{(\text{Normal current value} + \text{Burnout current value}) \times \text{Number of turns}}{2}$

- Make sure that the following conditions are satisfied:
 Heater with a current of less than 10.0 A:
 $(\text{Normal current value}) - (\text{Burnout current value}) \geq 1 \text{ A}$
 When the difference is less than 1 A, detection is unstable.
 Heater with a current of 10.0 A or more:
 $(\text{Normal current value}) - (\text{Burnout current value}) \geq 2.5 \text{ A}$
 When the difference is less than 2.5 A, detection is unstable.
- The setting range is 0.1 to 49.9 A. Heater burnouts and heater shorts are not detected when the set value is 0.0 or 50.0. When the set value is 0.0, the HB alarm is always OFF and the HS alarm is always ON. When the set value is 50.0, the HB alarm is always ON and the HS alarm is always OFF.
- Set the total current value for normal heater operation to 50 A or less. When a current value of 55.0 A is exceeded, *FFFF* is displayed in the Heater Current 1 Value Monitor and Leakage Current 1 Monitor parameters.

4-12-5 Application Examples

Example: Using a 200-VAC, 1-kW Heater

Normal

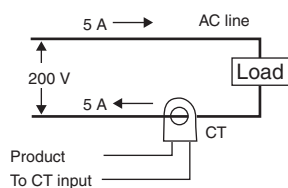

Burnout

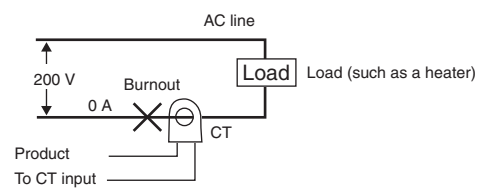

The heater power supply provides 5 A when the current is normal, and 0 A when there is a burnout, so the heater burnout detection current is calculated as follows:

$$\begin{aligned} \text{Heater burnout detection current} &= \frac{(\text{Normal current}) + (\text{Heater burnout current})}{2} \\ &= \frac{5 + 0}{2} = 2.5 \text{ [A]} \end{aligned}$$

Example: Using Three 200-VAC, 1-kW Heaters

Normal

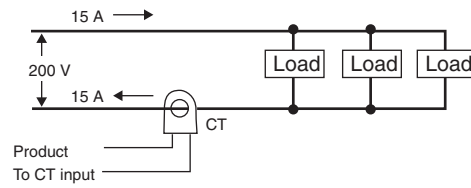

Burnout

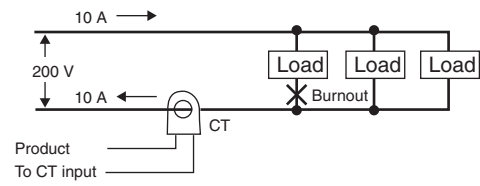

The heater power supply provides 15 A when the current is normal, and 10 A when there is a burnout, so the heater burnout detection current is calculated as follows:

$$\begin{aligned} \text{Heater burnout detection current} &= \frac{(\text{Normal current}) + (\text{Heater burnout current})}{2} \\ &= \frac{15 + 10}{2} = 12.5 \text{ [A]} \end{aligned}$$

4-13 Customizing the PV/SP Display

The following table shows the contents of the No. 1, 2, and 3 displays, according to the setting of the PV/SP Display Screen Selection parameter.

4-13-1 PV/SP Display Selections

The following table shows the contents of the No. 1, 2, and 3 displays, according to the setting of the PV/SP Display Screen Selection parameter in the Advanced Function Setting Level.

Set value	No. 1 display	No. 2 display	No. 3 display (E5ED or E5ED-B only)
0	Nothing is displayed.	Nothing is displayed.	Nothing is displayed.
1	PV	SP	Nothing is displayed.
2	PV	Nothing is displayed.	Nothing is displayed.
3	SP	SP (character display)	Nothing is displayed.
4	PV	SP	MV (Heating)
5	PV	SP	Multi-SP No.*
6	PV	SP	Soak Time Remain *
7	PV	SP	Internal Set Point (ramp SP)
8	PV	SP	Alarm Value 1*
9	PV	SP	MV (Cooling)*

* Nothing is displayed on the No. 1, 2, and 3 displays if the display conditions are not met.

	Monitoring range	Unit
PV	Temperature input: The specified range for the specified sensor. Analog input: Scaling lower limit -5%FS to Scaling upper limit +5%FS	EU

	Setting (monitoring) range	Unit
SP	SP lower limit to SP upper limit	EU

During temperature input, the decimal point position depends on the currently selected sensor, and during analog input it depends on the Decimal Point parameter setting.

PV/SP Display Selections

Code	Parameter	Default	Level
<i>SPd1</i>	PV/SP No. 1 Display Selection	4	Advanced Function Setting Level
<i>SPd2</i>	PV/SP No. 2 Display Selection	0	

5

Advanced Operations

5-1	Suppressing Temperature Variations When Using a Temperature Sensor for Packing Machines (for Packing Machines)	5-3
5-2	Automatically Adjusting a Water-cooling Output (for Water-cooled Extruders)	5-7
5-3	Performing Adaptive Control	5-11
5-3-1	Overview	5-11
5-3-2	Application Methods for Adaptive Control	5-19
5-4	Indication Data	5-21
5-5	Shifting Input Values	5-25
5-6	Setting Scaling Upper and Lower Limits for Analog Inputs	5-27
5-7	Executing Heating/Cooling Control	5-29
5-7-1	Heating/Cooling Control	5-29
5-8	Using Event Inputs	5-33
5-8-1	Event Input Settings	5-33
5-8-2	How to Use the Multi-SP Function	5-33
5-8-3	Operation Commands Other than Multi-SP	5-35
5-9	Setting the SP Upper and Lower Limit Values	5-39
5-9-1	Set Point Limiter	5-39
5-9-2	Setting	5-40
5-10	Using the SP Ramp Function to Limit the SP Change Rate	5-41
5-10-1	SP Ramp	5-41
5-11	Using the Key Protect Level	5-43
5-11-1	Protection	5-43
5-11-2	Entering the Password to Move to the Protect Level	5-44
5-12	Hiding and Displaying Parameters	5-46
5-12-1	Parameter Mask Setting	5-46
5-13	OR Output of Alarms	5-49
5-13-1	Integrated Alarm	5-49
5-14	Alarm Delays	5-51
5-14-1	Alarm Delays	5-51
5-15	Loop Burnout Alarm	5-53
5-15-1	Loop Burnout Alarm (LBA)	5-53

5-16 Performing Manual Control	5-56
5-16-1 Manual MV	5-56
5-17 Using the Simple Program Function	5-59
5-17-1 Simple Program Function	5-59
5-17-2 Operation at the Program End	5-62
5-17-3 Application Example Using a Simple Program	5-64
5-18 Output Adjustment Functions	5-65
5-18-1 Output Limits	5-65
5-18-2 MV at Stop	5-65
5-18-3 MV at PV Error	5-65
5-19 Using the Extraction of Square Root Parameter	5-67
5-19-1 Extraction of Square Roots	5-67
5-20 Setting the Width of MV Variation	5-69
5-20-1 MV Change Rate Limit	5-69
5-21 Setting the PF Key	5-70
5-21-1 PF Setting (Function Key)	5-70
5-22 Displaying PV/SV Status	5-73
5-22-1 PV and SV Status Display Functions	5-73
5-23 Logic Operations 000	5-75
5-23-1 The Logic Operation Function (CX-Thermo)	5-75
5-23-2 Using Logic Operations	5-75
5-24 Initializing Settings	5-84
5-25 Setting the Operating Status to Use When Power Is Turned ON	5-85
5-26 Using the Transfer Output for the Process Value, Set Point, or other Data 000	5-86
5-26-1 Transfer Output Function	5-86

5-1 Suppressing Temperature Variations When Using a Temperature Sensor for Packing Machines (for Packing Machines)

● Overview

The seal quality in packing machines is influenced by the temperature of the seal surface at the hot plates.

Traditionally, the temperature of hot plates in packing machines is measured a distance from the seal surface in the hot plates, which makes the measurement easily influenced by the heat from the heaters and creates a deviation between the measured temperature and the actual temperature of the seal surface.

- * The actual seal surface temperature is essentially the same as the surface temperature of the heating plate.

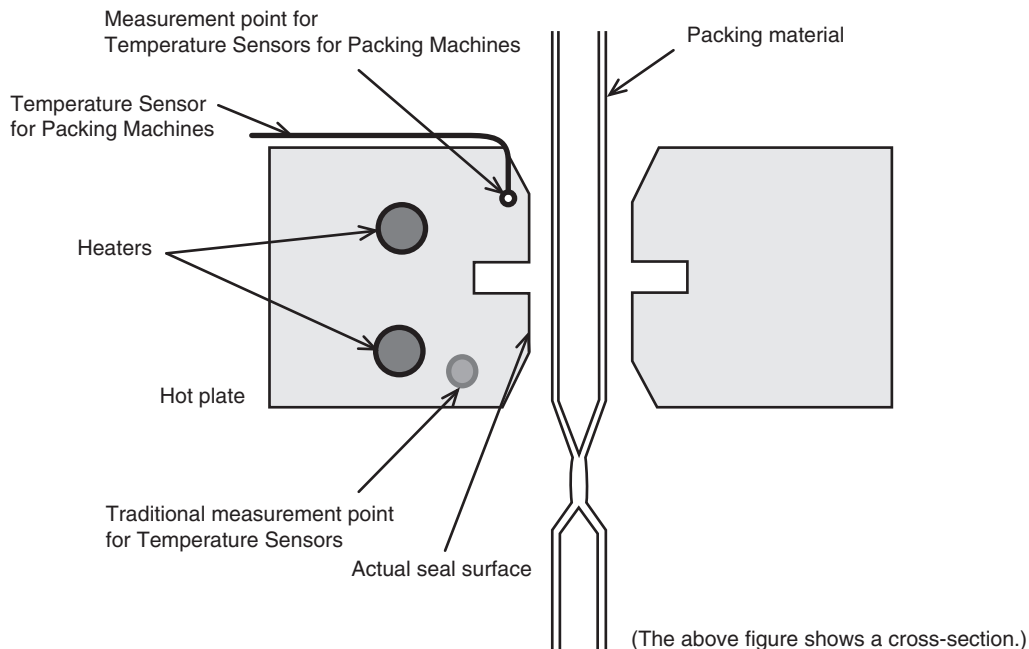

To solve this problem, OMRON provides Temperature Sensors for Packing Machines* and automatic filter adjustment to measure the surface temperature of the hot plate. If you use our Temperature Sensors for Packing Machines, you can measure the actual temperature of the seal surface. However, heat is taken from the packing materials, so periodic temperature variations can occur. If you also use the automatic filter adjustment function of the E5□D, you can automatically suppress these temperature fluctuations.

This lets you use the Temperature Sensors for Packing Machines together with automatic filter adjustment to control quality with the actual seal surface temperature while also suppressing temperature variations automatically without workers performing adjustments. You can also use automatic filter adjustment to suppress temperature variations for periodic disturbances even when using traditional temperature sensors.

- * Refer to 2-3 *Installing Temperature Sensors for Packing Machines*.

We recommend that you use automatic filter adjustment in the following cases.

- If temperature variation occurs when Temperature Sensors for Packing Machines are used even if AT is performed

- If temperature variation occurs after a heater is replaced
- If temperature variation occurs after packing materials are changed or the packing speed is changed
- If temperature variation occurs due to changes in the operating environment
- Example of Temperature Control with a Traditional Measurement Point

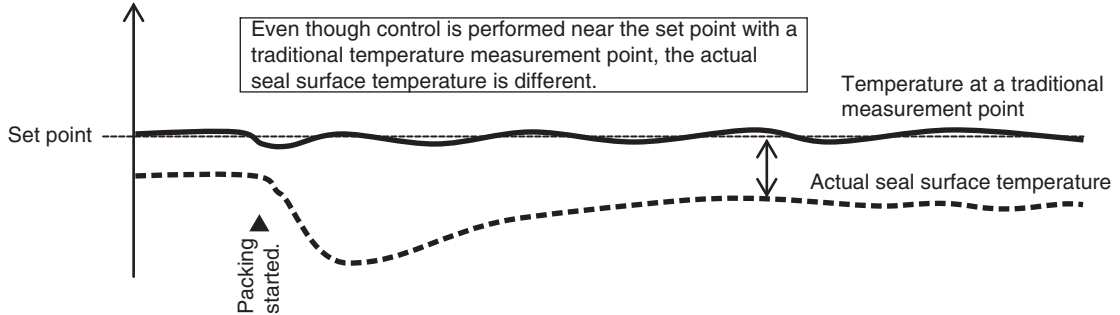

- Control Example Using a Temperature Sensor for Packing Machines

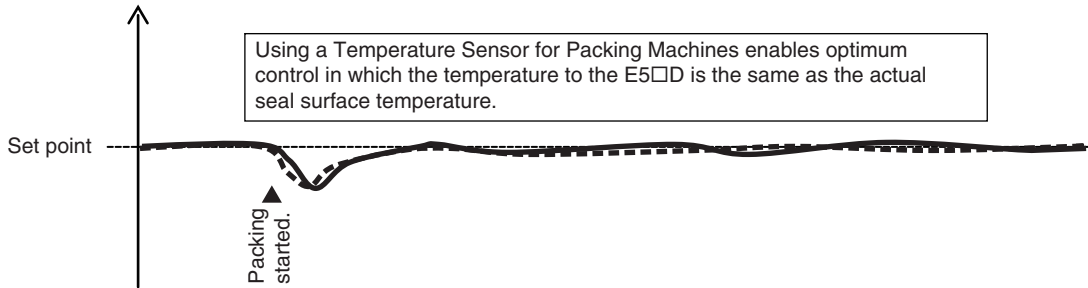

Particularly when packing materials are thick or the contents are cold, heat is taken from the hot plates and temperature variations occur. If normal temperature control is used in this case, there will be large temperature variations for each seal and over long periods of several tens of seconds. If this occurs, the automatic filter adjustment function of the E5□D can be used to improve control.

- Control Example Where Automatic Filter Adjustment Suppresses Temperature Variations Caused by a Temperature Sensor for Packing Machines

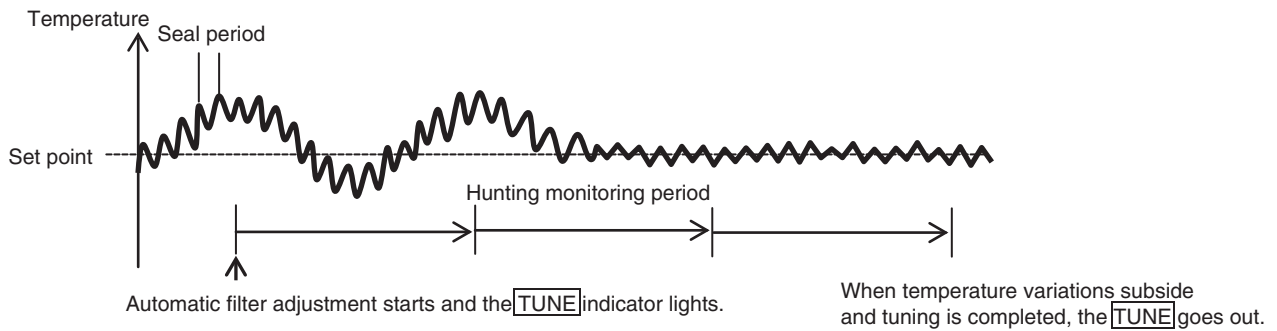

Note: When using automatic filter adjustment, turn ON power for the load (e.g., heater) at the same time as or before supplying power to the Digital Controller. Also, do not turn OFF the load power supply during the adjustment. Doing so will prevent correct calculation of the input digital filter.

● Parameters Related to Automatic Filter Adjustment

Parameter	Display	Set (monitor) values	Unit	Default	Level
Automatic Filter Adjustment*	FR	OFF: OFF ON: ON	---	OFF	Adjustment Level
Input Digital Filter	INF	0.0 to 999.9	Seconds	0.0	Adjustment Level
Automatic Filter Adjustment Seal Period*	FRSP	0.1 to 10.0	Seconds	2.0	Advanced Function Setting Level

Parameter	Display	Set (monitor) values	Unit	Default	Level
Automatic Filter Adjustment Hunting Monitor Period*	<i>FRHP</i>	10 to 1999	Seconds	200	Advanced Function Setting Level

* These parameters are displayed when 2-PID control or standard control (not heating/cooling control) is selected.

● Parameters

- Automatic Filter Adjustment (*FA*)
This parameter is used to execute automatic filter adjustment.
- Input Digital Filter (*INF*)
The set value of this parameter is used by a digital filter through which the sensor input passes to create a stable input value even when the sensor input value fluctuates due to noise. This parameter is automatically set when automatic filter adjustment is used.
- Automatic Filter Adjustment Seal Period (*FASP*)
This is the period of small temperature variations (up to several seconds) that occur in one seal. Normally, use the default for this parameter.*
- Automatic Filter Adjustment Hunting Monitor Period (*FRHP*)
This is the period of large temperature variations (several tens of seconds or longer) when packing.
Normally, use the default for this parameter.
If tuning for the automatic filter adjustment continues indefinitely or tuning requires a long time, measure the temperature waveform to set this parameter.*

* If tuning for the automatic filter adjustment continues indefinitely or tuning requires a long time, measure the temperature waveform to set this parameter according to the frequency of oscillation.

● Operating Conditions

Operation is possible when all of the following conditions are met.

- Startup Conditions
Automatic filter adjustment will start when all of the following conditions are met.
 - The PID ON/OFF parameter must be set to "PID."
 - The Standard or Heating/Cooling parameter must be set to "Standard."
 - The Auto/Manual parameter must be set to "Automatic."
 - The RUN/STOP parameter must be set to "RUN."
 - The AT Execute/Cancel parameter must be set to "AT Cancel."
 - There must be no input errors.
- Restrictions during Execution
During automatic filter adjustment, the settings of other parameters cannot be changed in the same way that they cannot be changed during auto-tuning.
However, the following parameters can be changed.
 - Auto/Manual
 - Communications Writing
 - RUN/STOP
 - Automatic Filter Adjustment
 - AT Execute/Cancel
 - Program Start (simple program)

Automatic filter adjustment will be cancelled in the following cases. The value of the Input Digital Filter parameter that was set during adjustment will not be saved.

- When the Automatic Filter Setting parameter is set to “OFF”
- When the RUN/STOP parameter is set to “STOP”
- When auto-tuning (AT) has been executed
- When the display is moved to the Initial Setting Level or Manual Control Level
- When a sensor error occurs
- When the temperature variations cannot be eliminated
- When the power supply is turned OFF

Calculations for the input digital filter will not be performed if the following things occur at startup.

- When the process value is not close to the set point
- When the SP ramp operates

● Using Automatic Filter Adjustment

Automatic filter adjustment will be performed with the following operation.

Execute auto-tuning in advance. Refer to 4-9-1 AT (Auto-tuning). Or, if you are also using adaptive control, make preparations for adaptive control in advance. (Refer to 5-3 Performing Adaptive Control)

Operating Procedure

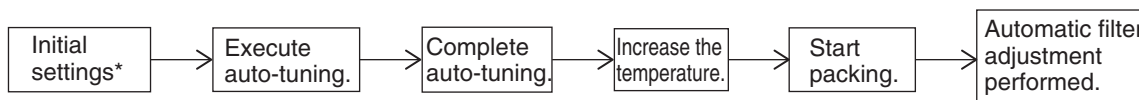

*For example, setting startup conditions.

- Automatic filter adjustment performed.

<p>1 Press the Key several times in the Adjustment Level to display FA (Automatic Filter Adjustment).</p>	<p>Adjustment Level</p> <p>Automatic Filter Adjustment</p>
<p>2 Press the or Key to select ON (ON). The TUNE indicator will light and the Input Digital Filter parameter will be set automatically.</p>	
<p>3 When adjustments have been completed, the TUNE indicator will go out. The Automatic Filter Adjustment parameter will automatically return to OFF (OFF).</p>	



Precautions for Correct Use

- If you use automatic filter adjustment, do not use manual operation to change the PID constants that were automatically set by auto-tuning. It may not be possible to suppress hunting in some cases.
- If you perform automatic filter adjustment when there is a continuous deviation between the process temperature and set point*, the input digital filter may not be adjusted correctly. Turn ON automatic filter adjustment when the process temperature is close to the set point.
 - * Examples of continuous deviation are given below.
 - Example 1: Heat cannot escape, so the temperature declines only slowly.
 - Example 2: The power supply to the heater is not turned ON.
- If a MV change rate limit has been set, the input digital filter may not be adjusted correctly.
- If there are water drops or similar object on the temperature sensor, the input digital filter may not be adjusted correctly.

5-2 Automatically Adjusting a Water-cooling Output (for Water-cooled Extruders)

● Overview

Mainly, this function simultaneously suppresses temperature variations in water-cooled extruders for the following two factors to maintain stable performance.

1. When the heat of vaporization is used as a cooling method, such as in water-cooled extruders, the cooling performance is nonlinear, so temperature variations can occur.
The water-cooling output adjustment function automatically suppresses hunting that occurs due to a water-cooling output.
2. With traditional auto-tuning, temperature variations can occur when changes in conditions during operation cannot be handled.
The water-cooling output adjustment function constantly monitors temperature changes and updates the cooling-side proportional band to help suppress temperature variations. You can disable water-cooling output adjustment after temperature variations have subsided to continue control with the cooling-side proportional band that was being used.

We recommend that you use water-cooling output adjustment in the following cases.

- If temperature variation occurs due to changes in the water-cooling system
- If temperature variation occurs due to changes in the cooling valve settings
- To reduce the amount of work required to adjust cooling valves

Water-cooling output adjustment works to suppress hunting by automatically increasing and decreasing the following value.

- Increasing the Cooling-side Proportional Band
The Proportional Band (Cooling) parameter is adjusted to suppress the width of temperature variations.
- Decreasing the Cooling-side Proportional Band
If disturbances results from heat generated by the material in the extruder or by screw friction, hunting will occur if the cooling capacity is too weak.
The Proportional Band (Cooling) parameter is adjusted to reduce the influence of hunting.

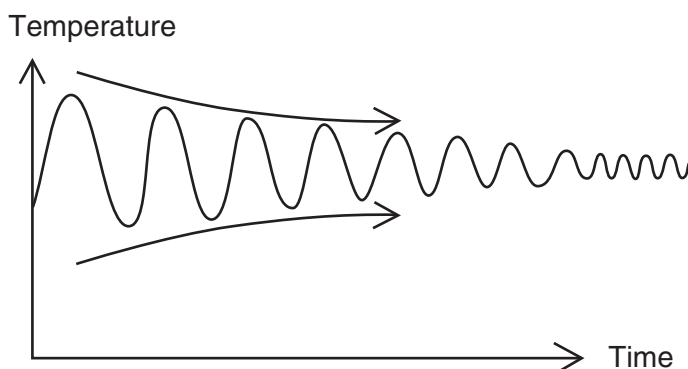

● Parameters Related to Water-cooling Output Adjustment

Parameter	Display	Set (monitor) values	Unit	Default	Level
Water-cooling Output Adjustment *1*2	$W-HL$	\bar{OFF} : Disabled \bar{ON} : Enabled	---	\bar{OFF}	Adjustment Level
Water-cooling Proportional Band Increase Threshold *1	$W-\bar{L}$	Water-cooling proportional band decrease threshold + 0.1 to 200.0	°C or °F	1.4	Adjustment Level
Water-cooling Proportional Band Decrease Threshold *1	$W-dL$	OFF or 0.1 to Water-cooling increase threshold - 0.1	°C or °F	0.6	Adjustment Level
Water-cooling Proportional Band Increase Constant *1	$W-\bar{L}$	1.00 to 10.00	---	1.70	Advanced Function Setting Level
Water-cooling Proportional Band Decrease Constant *1	$W-dL$	0.10 to 0.99	---	0.90	Advanced Function Setting Level
Proportional Band (Cooling)	$L-P$	0.1 to 999.9	Temperature input (°C or °F)	8.0	Adjustment Level
			Analog input (%FS)*3	10.0	

*1 These parameters are displayed when 2-PID control is used, a temperature input is used, heating/cooling control is used, and the Heating/Cooling Tuning Method parameter is set to "Water cooling."

*2 You can allocate an event input to water-cooling output adjustment and use the event input to enable and disable the function.

*3 Water-cooling output adjustment will not work with an analog input.

● Parameters

• Water-cooling Output Adjustment($W-HL$)

This parameter is used to enable or disable water-cooling output adjustment.

• Water-cooling Proportional Band Increase Threshold ($W-\bar{L}$)

This parameter sets the threshold for the temperature variation that is used to detect hunting. If the variation exceeds this threshold, the cooling proportional band is adjusted to reduce hunting. Normally, use the default for this parameter.

• Water-cooling Proportional Band Decrease Threshold ($W-dL$)

This parameter sets the threshold to the temperature variation that is used to detect when disturbance response is not optimal.

If the variation is less than or equal to this threshold, the cooling-side proportional band is adjusted to optimize disturbance response.

Normally, use the default for this parameter.

• Water-cooling Proportional Band Increase Constant ($W-\bar{L}$)

This parameter gives the increase constant when the value of the cooling proportional band is adjusted to reduce hunting.

This function works to suppress an excessive cooling output that may cause hunting when the cooling-side proportional band is increased

Normally, use the default for this parameter.

- Water-cooling Proportional Band Decrease Constant ($W-d\bar{L}$)
This parameter gives the decrease constant when the value of the cooling proportional band is adjusted to optimize disturbance response.
This function works to increase an insufficient cooling output that may reduce disturbance response when the cooling proportional band is decreased.
Normally, use the default for this parameter.
- Proportional Band (Cooling) ($\bar{L}-P$)
The set value of this parameter is used to calculate the manipulated value of the cooling output in proportion to the deviation between the process value and the set value. The water-cooling output adjustment function automatically adjusts the Proportional Band (Cooling) parameter.
If you set the cooling proportional band manually, first turn OFF water-cooling output adjustment.

● Operating Conditions

- Startup Conditions

Operation is possible when all of the following conditions are met.

- The input type must be set for a temperature input.
- The PID ON/OFF parameter must be set to "PID."
- The Standard or Heating/Cooling parameter must be set to "Heating/cooling."
- The Heating/Cooling Tuning Method must be set to "Water cooling."
- The Auto/Manual parameter must be set to "Automatic."
- The RUN/STOP parameter must be set to "Run."
- Reverse operation must be set.
- The AT Execute/Cancel parameter must be set to "AT Cancel."
- The Integral Time (Cooling) parameter must not be set to 0.
- The Water-cooling Output Adjustment parameter must be set to "ON."
- A SP ramp must not be operating.
- The process value must be close to the set point.
- There must be no input errors.

- Cancellation Conditions

Water-cooling output adjustment is cancelled in the following cases. The cooling-side proportional band that was being calculated is not saved.

- When the Auto/Manual parameter is changed to "Manual"
- When the RUN/STOP parameter is set to "STOP"
- When direct operation is used
- When the AT Execute/Cancel parameter is changed to "AT Execute"
- When the Integral Time (Cooling) parameter is changed to 0
- When the display is moved to the Initial Setting Level or Manual Control Level
- When a software reset is performed
- When a sensor error occurs

● Using Water-cooling Output Adjustment

Confirm that all of the previous startup conditions have been met.
Execute auto-tuning in advance. Refer to 4-9-1 AT (Auto-tuning).

Operating Procedure

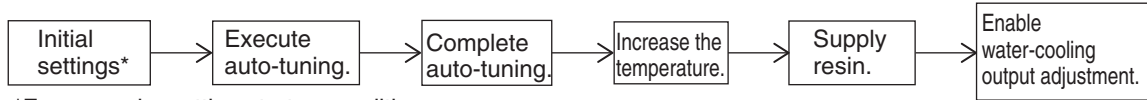

*For example, setting startup conditions.

- Setting Water-cooling Output Adjustment

<p>1 Press the Key several times in the Adjustment Level to display $W-HL$ (Water-cooling Output Adjustment). This parameter is not displayed if an event input is allocated to water-cooling output adjustment.</p>	<p>Adjustment Level</p> <div style="border: 1px solid black; padding: 5px; display: inline-block;"> $W-HL$ \bar{OFF} </div> <p>Water-cooling Output Adjustment</p>
<p>2 Press the or Key to select \bar{ON} (Enabled). Water-cooling output adjustment is started. It will stop if the parameter is changed to \bar{OFF} (Disabled).</p>	<div style="border: 1px solid black; padding: 5px; display: inline-block;"> $W-HL$ \bar{ON} </div>



Precautions for Correct Use

If you use water-cooling output adjustment, do not use manual operation to change the PID constants that were automatically set by auto-tuning. It may not be possible to suppress hunting in some cases.

5-3 Performing Adaptive Control

5-3-1 Overview

Adaptive control has the following two features.

1. You can increase control performance over traditional auto-tuning.
2. Even if factors emerge during long-term equipment operation that cause temperature variations and influence system characteristics, such as changes in the operating environment or equipment deterioration, the changes can be followed to maintain high control performance.

We recommend adaptive control in the following cases.

- When satisfactory control is not possible with the PID constants calculated with auto-tuning
- When high control performance cannot be maintained due to temporal variations in system characteristics, such as changes in the environment or equipment deterioration

Broadly speaking, adaptive control provides the following two functions.

- Control with PID constants that are optimum for the system characteristics
- Maintenance of optimum status following changes in system characteristics

You can also use only the function to find the optimum PID constants for the system characteristics.

1. Control with PID Constants That Are Optimum for the System Characteristics

To find the PID constants for adaptive control, set adaptive control ($AdPt$) for automatic updating ($Auto$) and then perform the following procedure.

- 1** Perform auto-tuning to determine system characteristics.
- 2** Lower the temperature sufficiently.
- 3** Increase the temperature to the set point. While the temperature is rising, system performance will be evaluated and the PID constants for adaptive control will be calculated automatically. (The A indicator will flash during this process.)
- 4** From here on, control will be performed with the PID constants for adaptive control. The PID constants for adaptive control will reflect the system characteristics more than the PID constants calculated with auto-tuning to enable better control.

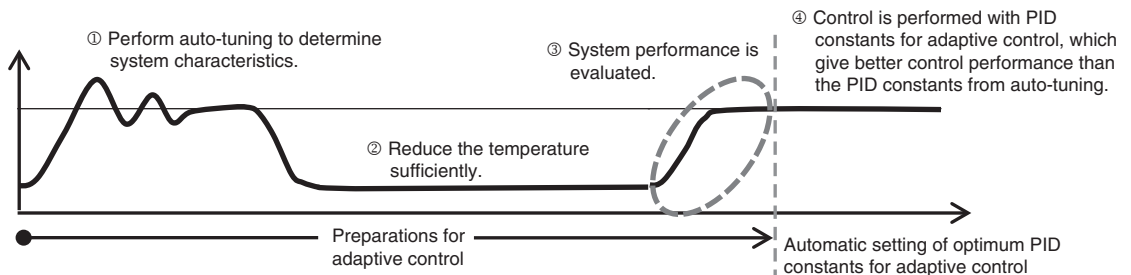

Note: When using adaptive control, turn ON power for the load (e.g., heater) at the same time as or before supplying power to the Digital Controller. If you turn ON the power supply to the load after you turn ON the power supply to the Digital Controller, correct system performance evaluation will not be possible, the PID constants for adaptive control will not be calculated correctly, and you will not achieve optimum control.

2. Maintenance of Optimum Status Following Changes in System Characteristics

After the PID constants for adaptive control are calculated, the system performance is evaluated each time the equipment is started and the PID constants for adaptive control are updated according to any changes. Therefore, even if the heater or other equipment deteriorates over time and system performance changes gradually, control with the optimum PID constants is possible.

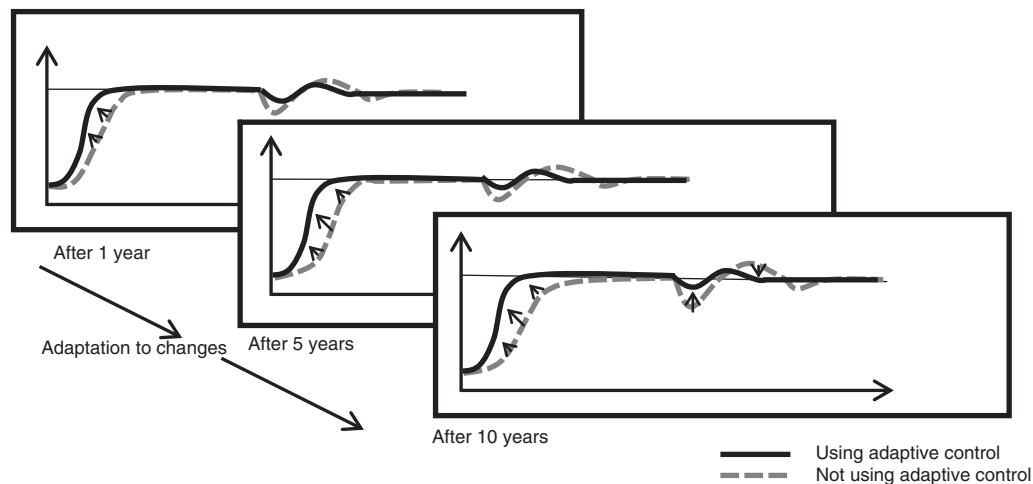

- Note 1. The expected performance will not be achieved if heaters deteriorate to the point where there is insufficient capacity to reach the set point.
2. This function cannot be used during any of the following: heating/cooling control, an analog input type, direct operation, and SP ramp operation.

Related Parameters

Parameter	Display	Set (monitor) values	Default	Level
Adaptive Control	<i>RdPE</i>	$\bar{\alpha}FF$: Disabled $\bar{FL}x$: Fixed $\bar{CNF}\bar{\alpha}$: Notification $\bar{RUt}\bar{\alpha}$: Automatic update	$\bar{\alpha}FF$	Initial Setting Level
PID Update (adaptive control)	<i>R-Ud</i>	$\bar{\alpha}FF$: OFF $\bar{\alpha}N$: Updated	$\bar{\alpha}FF$	Adjustment Level
Adaptive Control Operation Possible Deviation	<i>R-dV</i>	0.0% to 100.0% 0°C (32°F) to Set point = 100%	50.0	Advanced Function Setting Level
System Fluctuation Reference Deviation	<i>R-5d</i>	0.0% to 100.0%	15.0	Advanced Function Setting Level

The following parameters are also available. These parameters are set automatically, so there is no need to change the settings.

- Model Parameters: These parameters are set to determine the system characteristics with auto-tuning.
- SP response PID constants, disturbance PID constants, and SP Response Coefficient Number: These PID constants are used for adaptive control. Refer to 5-14.

Parameters

● Adaptive Control ($R_d P_t$)

If the Adaptive Control parameter is set to anything except $\bar{a}FF$ (Disabled), control is performed with the PID constants for adaptive control.

After you set this parameter, perform either 40% or 100% auto-tuning.

After auto-tuning is completed, stop control (STOP or turn OFF the power supply), allow the temperature to drop sufficiently, and then start control (RUN) again.

If you do, operation will be performed according to the setting of the Adaptive Control parameter, as described below.

● Setting Value of $R_{U\bar{t}\bar{a}}$ (Automatic Update)

System performance is evaluated and the PID constants for adaptive control are updated automatically. This enables continuous control with the optimum PID constants. The \boxed{A} indicator flashes during system performance evaluation and goes out when evaluation is completed.

● Set Value of $\bar{L}NF\bar{a}$ (Notification)

If system fluctuations occur after system performance is evaluated, the PID constants for adaptive control are updated by the user.

This setting can be used so that the user can confirm changes in the environment or deterioration in equipment.

The \boxed{A} indicator flashes during system performance evaluation. If the PID constants need to be updated, the \boxed{A} indicator will light to provide notification of changes in the operating environment or deterioration in equipment. If the fluctuation in the system is small, the \boxed{A} indicator will not light, but the adaptive control PID constants will be calculated.

To update the PID constants, the user changes the setting of the $R-Ud$ (PID Update) parameter described below to $\bar{a}N$ (Update). The notification display (\boxed{A} indicator) will appear the third time system performance is evaluated.

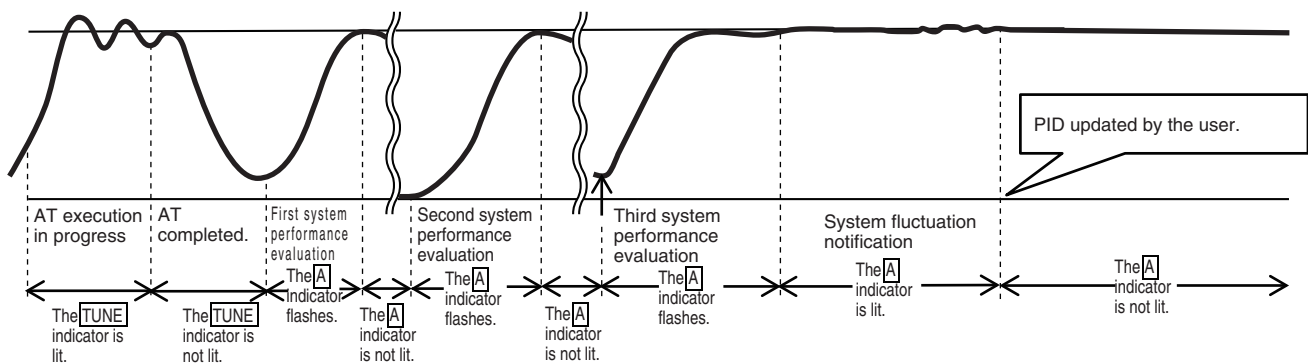

● Set Value of $F\bar{L}\bar{x}$ (Fixed)

System performance is not evaluated.

Use this setting when you want to calculate the PID constants for adaptive control with $R_{U\bar{t}\bar{a}}$ (Automatic update) or $\bar{L}NF\bar{a}$ (Notification), and then perform control with the calculated PID constants for adaptive control without changing them. If the set value is $F\bar{L}\bar{x}$ (Fixed), you can display and check the SP response PID constants and disturbance PID constants in the Adjustment Level.

The \boxed{A} indicator will remain not lit.

● Set Value of $\bar{a}FF$ (Disabled)

Adaptive control is disabled. Operation uses 2-PID control.

● PID Update (Adaptive Control) ($R-Ud$)

This parameter is displayed if the Adaptive Control parameter is set to $\bar{L}NF\bar{a}$ (Notification) and updateable PID constants are calculated.

This setting is used to manually update the PID constants to newly calculated PID constants. The parameters can be updated in the following two cases.

- When PID Update parameter is being displayed
- When the Enable PID Constants for Adaptive Control Bit in the communications status is ON.

If you use the Ⓢ Key to change the setting from $\bar{a}FF$ (OFF) to $\bar{a}N$ (Update), the PID values are updated to the values calculated with system performance evaluation. After the setting is updated, the $R-Ud$ display disappears and the next parameter will be displayed.

After the setting is updated, the notification display (Ⓢ indicator) will appear the third time system performance is evaluated.

To prevent updating, perform one of the following operations. The Ⓢ indicator will go out.

- Cycle the power supply.
- Set the Adaptive Control parameter for fixed operation ($F\bar{L}\bar{x}$).
- Perform a software reset.

● Adaptive Control Operation Possible Deviation ($R-dv$)

The set value of this parameter is used to determine if system performance evaluation for adaptive control is possible based on the relationship between the process value and set point when control is started.

This parameter gives the temperature range over which system performance evaluation is performed using the temperature width from 0°C to the set point as 100%. The default is 50.0 (%). To ensure the performance of adaptive control, do not set a value less than 50%.

If the Adaptive Control Operation Possible Deviation parameter is set to 50%, system performance evaluation for adaptive control will not be performed if the starting temperature is 50% of the set point or higher from 0°C. (The Ⓢ indicator will not flash and will not be lit.)

Example: If the set point is 280°C, the temperature range at which adaptive control is possible is 140°C.

If the temperature is 140°C or lower when adaptive control is enabled, adaptive control will be performed. If the temperature is greater than 140°C, adaptive control will not be performed.

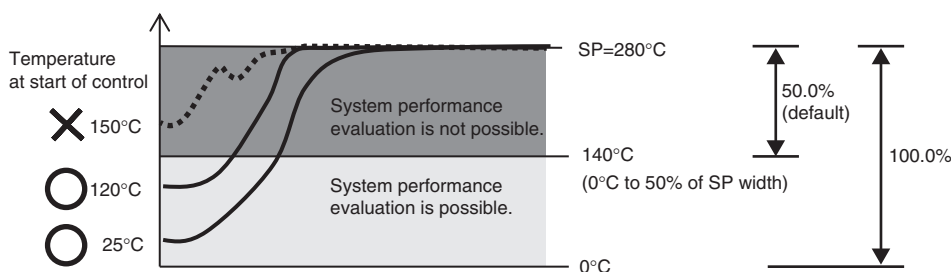

● System Fluctuation Reference Deviation ($R-5d$)

This parameter is displayed when the Adaptive Control parameter is set to $\bar{L}NF\bar{a}$ (Notification).

If the rate of change in the proportional band* that is calculated for system performance evaluation exceeds this reference value, the Ⓢ indicator lights to provide notification of a temperature variation in the system.

The default is 15.0%.

* This is the rate of change in the proportional band calculated for the second system evaluation.

● **Model Parameters**

These parameters express the characteristics of the system.

These parameters are displayed when the Adaptive Control parameter is not set to $\bar{\alpha}FF$ (Disabled).

The model parameters are calculated automatically if auto-tuning is performed when the Adaptive Control parameter is set to $\bar{R}U\bar{L}\bar{\alpha}$ (Automatic update) or $\bar{L}NF\bar{\alpha}$ (Notification). They do not need to be set by the user. Also, this parameter is copied so that another Digital Controller can inherit the measured system characteristics.

Parameter	Display	Setting range	Unit	Default	Level
Model Creation PV Amplitude	$M-PV$	0.00 to 99.99	%FS	0.00	Initial Setting Level
Model Creation MV Amplitude	$M-MV$	0.0 to 100.0	%FS	0.0	Initial Setting Level
Model Creation ON Time	$M-\bar{\alpha}N$	0 to 9999	---	0	Initial Setting Level
Model Creation OFF Time	$M-\bar{\alpha}F$	0 to 9999	---	0	Initial Setting Level

● **SP Response PID Constants, Disturbance PID Constants, and SP Response Coefficient Number**

These parameters are necessary to perform adaptive control.

Adaptive control is performed with different PID constants for transient control states and steady states. These two sets of PID constants (SP response PID constants and disturbance PID constants) are used with the SP Response Coefficient Number to automatically calculate the optimum values following changes in the equipment based on system performance evaluation. It is not necessary for you to set these parameters.

These parameters are displayed only when the Adaptive Control parameter is set to $\bar{F}\bar{L}\times$ (Fixed).

They are not displayed while the Adaptive Control parameter is set to $\bar{R}U\bar{L}\bar{\alpha}$ (Automatic update) or $\bar{L}NF\bar{\alpha}$ (Notification).

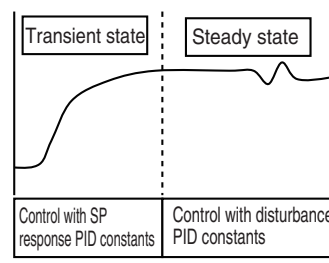

The following parameters are available.

Parameter	Display	Setting range	Unit	Default	Level
SP Response Proportional Band	$\bar{S}P-\bar{P}$	0.1 to 999.9	Temperature input °C °F	8.0 14.4	Adjustment Level
SP Response Integral Time	$\bar{S}P-\bar{I}$	Integral/Derivative Time Unit of 1 s: 0 to 9,999	Seconds	233	Adjustment Level
		Integral/Derivative Time Unit of 0.1 s: 0.0 to 999.9		233.0	
SP Response Derivative Time	$\bar{S}P-d$	Integral/Derivative Time Unit of 1 s: 0 to 9,999	Seconds	40	Adjustment Level
		Integral/Derivative Time Unit of 0.1 s: 0.0 to 999.9		40.0	
SP Response Coefficient Number	$\bar{S}P-N$	0 to 9999	---	0	Adjustment Level
Disturbance Proportional Band	$d-\bar{P}$	Same as SP Response Proportional Band.	Same as SP Response Proportional Band.	Same as SP Response Proportional Band.	Adjustment Level
Disturbance Integral Time	$d-\bar{I}$	Same as SP Response Integral Time.	Same as SP Response Integral Time.	Same as SP Response Integral Time.	Adjustment Level
Disturbance Derivative Time	$d-d$	Same as SP Response Derivative Time.	Same as SP Response Integral Time.	Same as SP Response Integral Time.	Adjustment Level



Additional Information

Reducing Tuning Work for Replacing the E5□D or for Equipment Mass Production

If you replace the E5□D or are mass-producing the same equipment, you can copy model parameters to eliminate the need to repeat tuning (AT with system performance evaluation) and perform adaptive control with the same system performance.

Adaptive Control Set to Notification or Automatic Update

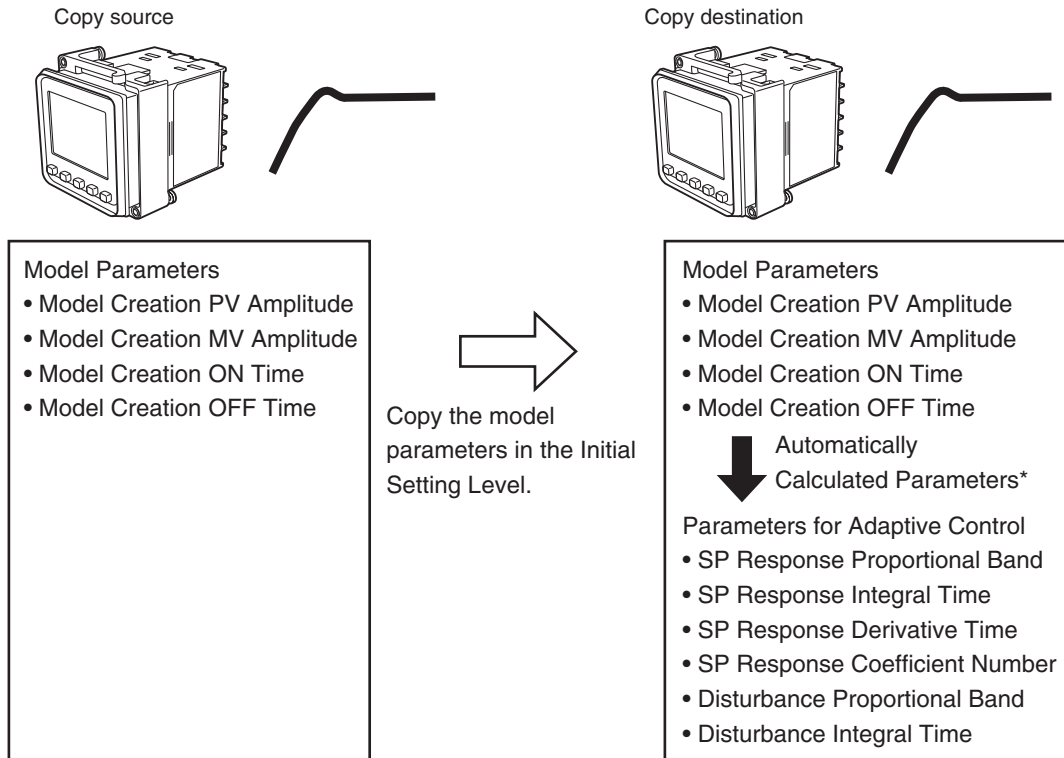

* Characteristics are determined from the model parameters and the adaptive control PID constants are automatically calculated. When system performance is evaluated, the PID constants are automatically updated to match the system at the copy destination.

Adaptive Control Set to Fixed

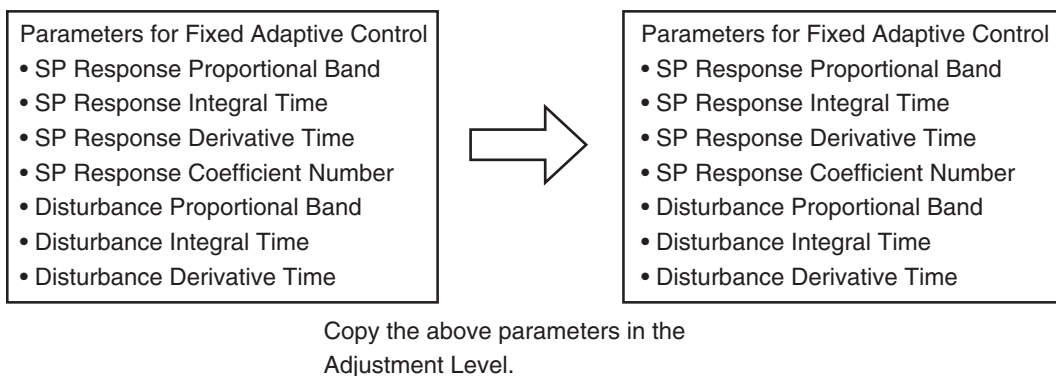

Precautions for Correct Use

- Before you copy the model parameters, set the input type and temperature unit. If you change these setting later, the model parameters will be initialized.
- If you have changed the AT Hysteresis or AT Calculated Gain parameters from their default values on the copy source Digital Controller, copy the AT Hysteresis and AT Calculated Gain parameters before you copy the model parameters. Calculation error will occur when calculating adaptive control PID constants from model parameters.

Operating Conditions

Adaptive control is possible when all of the following conditions are met.

- Display Conditions for Adaptive Control Parameter

RdPt (Adaptive Control) is displayed in the Initial Setting Level when all of the following conditions are met.

- The Standard or Heating/Cooling parameter must be set to “Standard.”
 - The input type must be set for a temperature input.
 - The PID ON/OFF parameter must be set to “PID.”
- Conditions for System Performance Evaluation
- System performance evaluation is performed when all of the following conditions are met.
- The Adaptive Control parameter must be set to “Automatic update” or “Notification.”
 - The Auto/Manual parameter must be set to “Auto.”
 - The Direct/Reverse Operation parameter must be set to “Reverse operation.”
 - The AT Execute/Cancel parameter must be set to “AT Cancel.”
 - The SP Ramp Set Value parameter must be set to “OFF.”
 - The SP Ramp Fall Value parameter must be set to “OFF” or “SAME.”
 - All of the model parameters must not be at the default values.
 - The starting temperature must be separated from the set point by at least the adaptive control operation possible deviation.
 - The starting temperature must be separated from the set point by at least 10°C.
 - The starting temperature must be at least 0°C.
 - System performance evaluation must not start immediately after recovery from an input error.

Startup Conditions

- When power is turned ON with the RUN/STOP parameter set to RUN
- When the RUN/STOP parameter is changed from STOP to RUN after the power supply is turned ON

Restrictions

1. Starting Temperature Restriction

If the control starting temperature is equal to or greater than the temperature set in the Adaptive Control Operation Possible Deviation parameter, system performance will not be evaluated.

2. Set Point Change Restriction

The set point can be changed, but if the change is too large, system characteristics will change and may influence control performance.

We recommend that you perform auto-tuning again if the set point is changed by more than the following range.

Set point calculated during AT $\pm 30\%$

3. Changes to Parameters during System Performance Evaluation

If any of the following parameters is changed during system performance evaluation (i.e., when the Δ indicator is flashing or lit), system performance evaluation and notification will be cancelled. The PID constants will not be updated.

- Set point currently being used
- Multi-SP
- SP Ramp Rise Value
- SP Ramp Fall Value
- PV Input Shift
- PV Input Slope Coefficient
- MV Upper Limit
- MV Lower Limit
- MV Change Rate Limit
- SP response PID constants
- SP Response Coefficient Number
- Disturbance PID constants

4. Restrictions in Changes to Parameters after System Performance Evaluation

If any of the following parameters, which restrict inputs to the system or outputs from the system, are changed, they will be considered system fluctuations and system performance evaluation will be performed the next time control is started.

- Moving Average Count
- PV Input Shift
- PV Input Slope Coefficient
- Input Digital Filter
- MV Upper Limit/MV Lower Limit
- MV Change Rate Limit
- Control Period
- SP response PID constants
- SP Response Coefficient Number
- Disturbance PID constants

5. Display Conditions for SP Response PID Constants and Disturbance PID Constants

If the Adaptive Control parameter is set to $Auto$ (Automatic update) or $Notify$ (Notification), you will not be able to display the SP response PID constants and disturbance PID constants in the Adjustment Level. Set the Adaptive Control parameter to $Fixed$ (Fixed) to display them. You can also confirm the settings with communications.

6. Initializing Model Parameters

The model parameters will be initialized if you change any of the following parameters, which are related to the input range. To use adaptive control, perform auto-tuning again.

- Input Type
- Temperature Unit



Precautions for Correct Use

The effectiveness of adaptive control may not be achieved under the following conditions.

- Heaters for which there is a large change in the resistance depending on the temperature
- Devices for which boiling or melting occurs
- Devices for which there is high thermal interference
- Devices that reach the set point in 5 s or less
- Devices that have a set point near room temperature
- When large disturbances (temperature fluctuations) occur during system performance evaluation (Δ flashing).
- When the MV upper limit is less than 100%
- When the MV lower limit is greater than 0%
- When an MV change rate limit is set
- When the MV is not 0% when stopping

5-3-2 Application Methods for Adaptive Control

You can set the following three operations for adaptive control.

Mode	Description
Automatic update	Control is performed with the PID constants for adaptive control and the PID constants are updated automatically according to system fluctuations.
Notification	Control is performed with the PID constants for adaptive control, notification is provided for the PID constants according to system fluctuations, and the user determines when to update the PID constants.
Fixed	The PID constants for adaptive control are used, but control is performed without changing the PID constants.

The setup and procedural flow is given below.

Power ON



Initial Setting Level

- Input type = Temperature input (default: thermocouple K (5) (Select a thermocouple, resistance thermometer, or infrared temperature sensor.) Required
- PID ON/OFF = PID (default) Required
- Standard or Heating/Cooling = Standard (default) Required
- Auto/Manual = Auto (default) Required
- Direct/Reverse Operation = Reverse operation (default) Required
- SP Ramp Set Value = OFF (default) Required
- Control Period
- Alarm Type and other parameters

Setting Up Adaptive Control

* To use the "Fixed" setting, first perform system performance evaluation by setting "Automatic update" or "Notification," and then change the setting to "Fixed."

Operating Procedure

● Setting Up Adaptive Control

1. Press the Key several times in the Initial Setting Level to display *AdPt* (Adaptive Control).



2. Press the to select auto (Automatic update). The default is *OFF* (OFF).



Preparations for Adaptive Control

* If you change the Input Type or Temperature Unit parameter during adaptive control, perform the operation again from this procedure.

Set the set point in Operation Level.



Execute 100% AT (AT-2, recommended) in the Adjustment Level.

The **TUNE** indicator will light.

*The system characteristics are determined. (The model parameters are set automatically.)



After auto-tuning is completed, turn OFF the power supply or STOP and allow the temperature to drop sufficiently.*3

The **TUNE** indicator will go out.



Turn ON the power supply or RUN and increase the temperature.*1

The **A** indicator will flash.

*System performance is evaluated.



Go to Setting Up Adaptive Control (Automatic Update or Notification and Then Changing to Fixed Control When Necessary) on the next page.

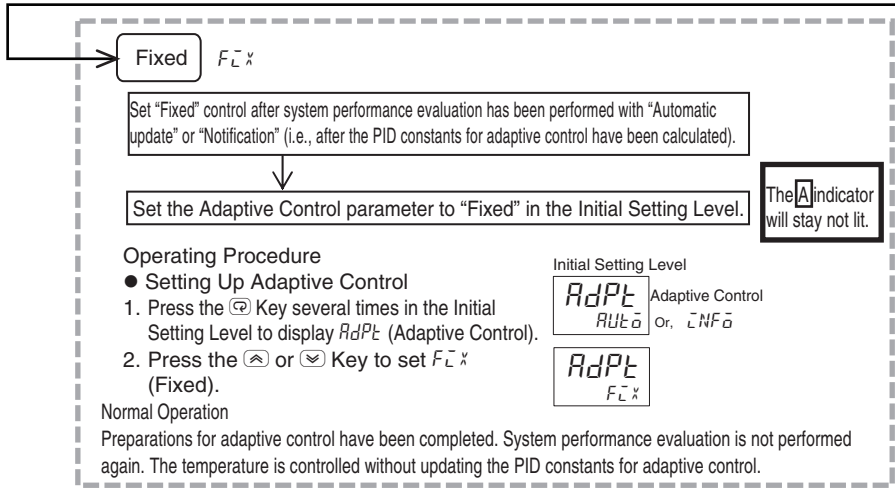
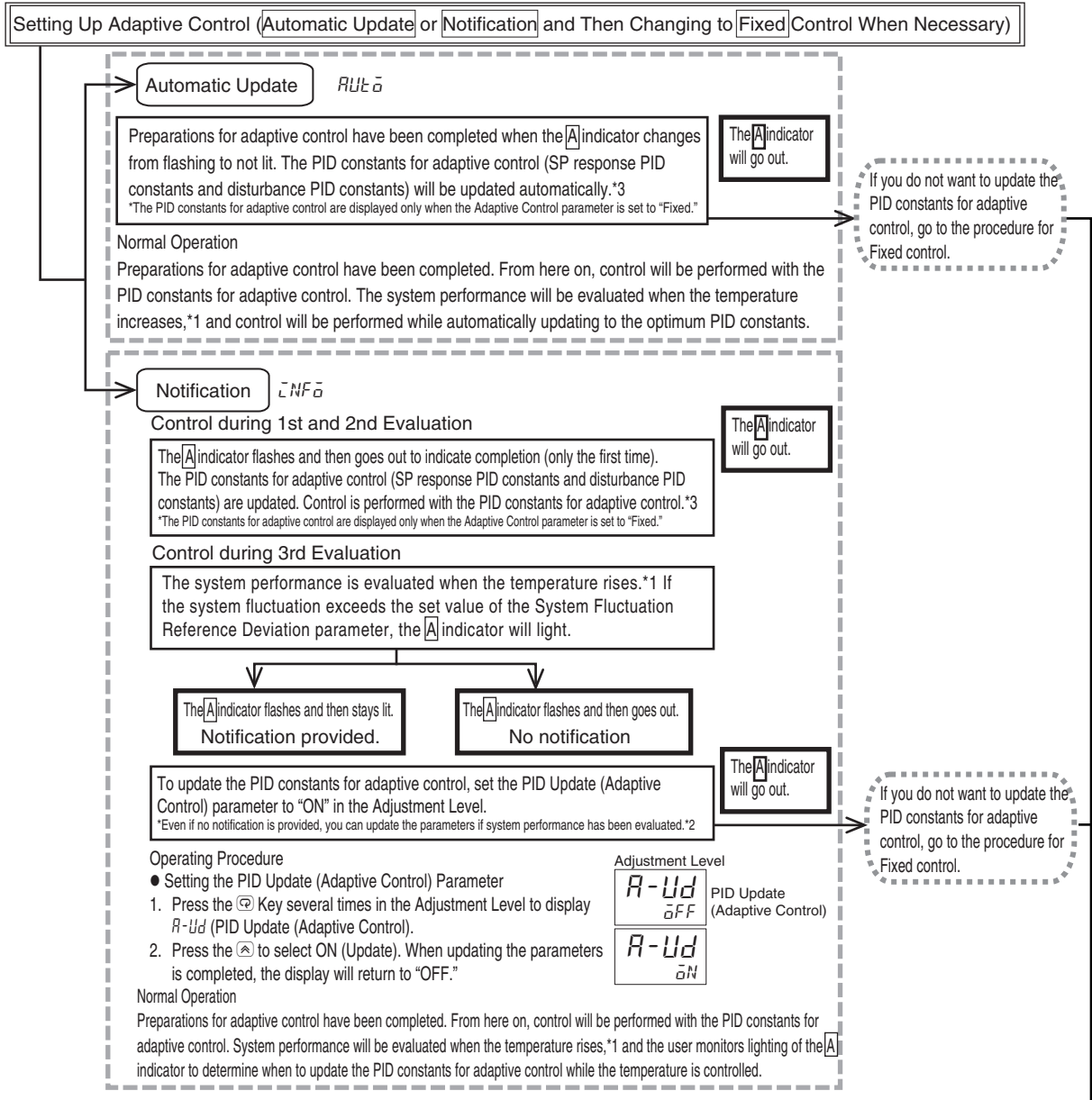

*1: System performance is evaluated if the temperature exceeds the set value of the Adaptive Control Operation Possible Deviation parameter.

*2: You can use the following methods to determine if the PID constants for adaptive control can be updated or not.

- Display the PID Update parameter.
- Turn ON the Enable Update PID Constants for Adaptive Control Bit in the communications status.

*3: Do not change the PID constants for adaptive control with manual operation. If you do, error will occur in the PID calculations for system performance evaluation.

5-4 Indication Data

● Overview of Functions

The E5□D contains indication data that can be used to help monitor trends in panel equipment, predict product service life, and determine replacement periods.

You can use this data to collect and analyze data and make predictions in the host system.

- Ambient temperature monitor: You can display the temperature around the terminals or read it with communications. You can monitor trends in the ambient temperature to monitor for abnormal heat generation in the panel.
- Power ON time data: You can display the total power ON time of the Digital Controller or read it with communications.
The service life of the Digital Controller and equipment depends on the operating environment.
You can collect power ON time data to clarify the relation between the operating environment and service life and use it to predict future machine maintenance periods and to improve the operating environment.
- Control output ON/OFF count monitors: The contacts in the relays have a service life. You can display the number of relay ON/OFF operations or read it with communications.
You can monitor this data to determine replacement periods before the service life count to make maintenance more efficient.

● Power ON Time Data

You can display the power ON time of the E5□D or monitor it through communications.

The monitoring range is 0 to 99,990 hours. Power ON time is not recorded beyond that. The user cannot initialize the power ON time data.

There is no function to link this data with an alarm output.

Monitor data	Display	Monitor range	Unit	Default	Level
Power ON Time Monitor	<i>PWLM</i>	0 to 9999	10 hours	0	Advanced Function Setting Level

● Ambient Temperature Monitor

You can monitor the temperature around the terminals on the E5□D, but you cannot link this to an alarm output. This is a predictive value based on the temperature sensor element inside the E5□D. Reference accuracy: Typically $\pm 3^{\circ}\text{C}$

Monitor data	Display	Monitor range	Unit	Default	Level
Ambient Temperature Monitor	<i>AbEM</i>	-30 to 75 10 to 171	$^{\circ}\text{C}$ $^{\circ}\text{F}$	---	Advanced Function Setting Level

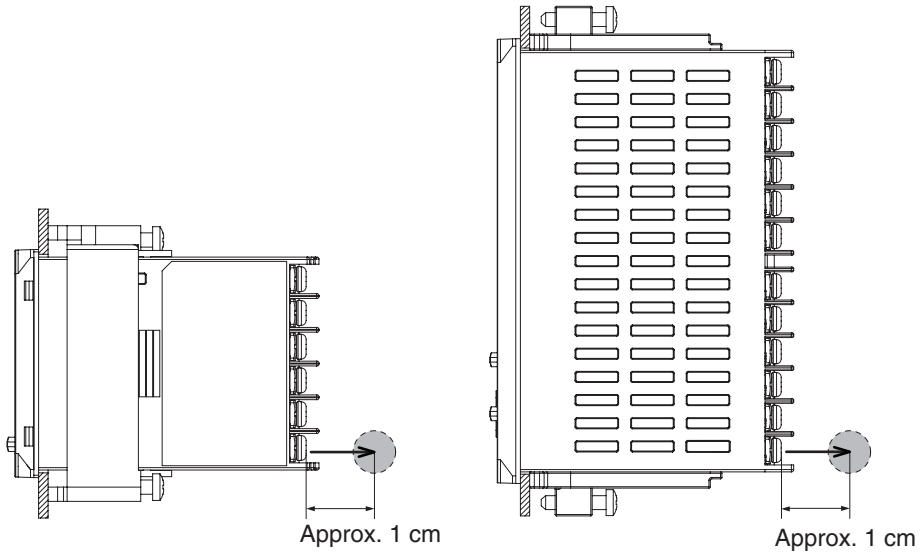

● Control Output ON/OFF Count Monitors

With Control Output 1 and 2 ON/OFF outputs (relay outputs or voltage outputs for driving SSR), the number of times that a control output turns ON and OFF can be counted.

You can display the counts or monitor them through communications.

The monitor range is 0 to 999,900 times. The counts are not recorded beyond that.



There is no function to link this data with an alarm output.

There is a function to reset the control output ON/OFF counts. (Resetting is possible only with a key operation.)



Setting/monitor data	Display	Monitor range	Unit	Default	Level
Control Output 1 ON/OFF Count Monitor	<i>RA1M</i>	0 to 9999	100 times	0	Advanced Function Setting Level
Control Output 2 ON/OFF Count Monitor	<i>RA2M</i>	0 to 9999	100 times	0	Advanced Function Setting Level
ON/OFF Counter Reset	<i>RAC</i>	0: Resetting is disabled. 1: Control Output 1 ON/OFF Count Monitor parameter is reset. 2: Control Output 2 ON/OFF Count Monitor parameter is reset.	---	0	Advanced Function Setting Level

Operating Procedure









- Checking the Power ON Time Monitor

<p>1 Press the  Key several times in the Advanced Function Setting Level to display <i>PWEM</i> (Power ON Time Monitor).</p>	<p>Advanced Function Setting Level</p>  <p>Power ON Time</p>
<p>2 Check the power ON time. Every 10 hours is one count. Therefore, in the example on the right, the power ON time is between 10 hours and 19 hours 59 minutes.</p>	

- Checking the Ambient Temperature Monitor

<p>1 Press the  Key several times in the Advanced Function Setting Level to display <i>AbEM</i> (Ambient Temperature Monitor).</p>	<p>Advanced Function Setting Level</p>  <p>Ambient Temperature</p>
<p>2 Check the ambient temperature. In the example on the right, the temperature would be 28°C if the temperature unit was °C.</p>	

- Checking and Resetting the Control Output 1 ON/OFF Count Monitor

<p>1 Press the  Key several times in the Advanced Function Setting Level to display <i>RA 1M</i> (Control Output 1 ON/OFF Count Monitor).</p>	<p>Advanced Function Setting Level</p> <div style="border: 1px solid black; padding: 5px; display: inline-block;">  </div> <p>Control Output 1 ON/OFF Count</p>
<p>2 Check the control output 1 ON/OFF count. Every 100 operations is one count. Therefore, in the example on the right, the ON/OFF count is between 100 and 199 times.</p>	<div style="border: 1px solid black; padding: 5px; display: inline-block;">  </div>
<p>3 Press the  Key several times to select <i>RAC</i> (ON/OFF Counter Reset). Press the  or  Key to select "1." The Control Output 1 ON/OFF Count Monitor parameter will be reset to 0. Press the  or  Key to select "2." The Control Output 2 ON/OFF Count Monitor parameter will be reset to 0. The display will return to 0 after the counter is reset.</p>	<p>Advanced Function Setting Level</p> <div style="border: 1px solid black; padding: 5px; display: inline-block;">  </div> <p>ON/OFF Counter Reset</p>

5-5 Shifting Input Values

● Shifting Inputs

You can set the Process Value Slope Coefficient and Process Value Input Shift parameters to compensate the PV.

Parameter	Setting range	Unit	Default
Process Value Input Shift	Temperature input: -199.9 to 999.9	°C or °F	0.0
	Analog input: -1,999 to 9,999	EU	0
Process Value Slope Coefficient MASK8	0.001 to 9.999	None	1.000

- Calculating the Process Value Slope Coefficient and Process Value Input Shift

In the following equation, PV_i is the input to the calculation, PV_o is the result, $INRT$ is the process value slope coefficient, and INS is the process value input shift: $PV_o = (PV_i \times INRT) + INS$

● Moving Average

- The moving average operation reduces sudden changes in the input due to noise and other factors, and can be enabled separately for each input.
- The Moving Average Count parameter is used for the moving average. It can be set to OFF, 2, 4, 8, 16, or 32.
- The default is OFF (disabled).*

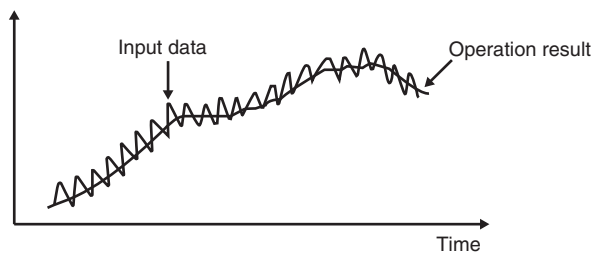

Parameter	Setting range	Unit	Default
Moving Average Count	OFF, 2, 4, 8, 16, or 32	Times	OFF*

* The default is 8 for models other than the E5□D-□-8□□.

● Input Digital Filter

You can use the input digital filter to help remove the noise component from input signals.

If you set the Input Digital Filter parameter to any value other than 0.0, the filter works as a robust filter to reduce high-frequency noise.

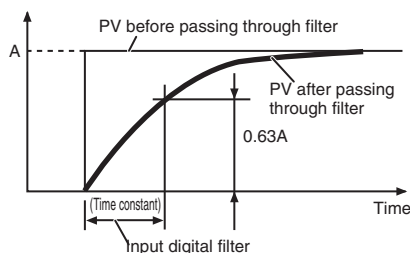

Setting range	Unit	Default
0.0 to 999.9	Seconds	0.0

● Using the PV Input Shift

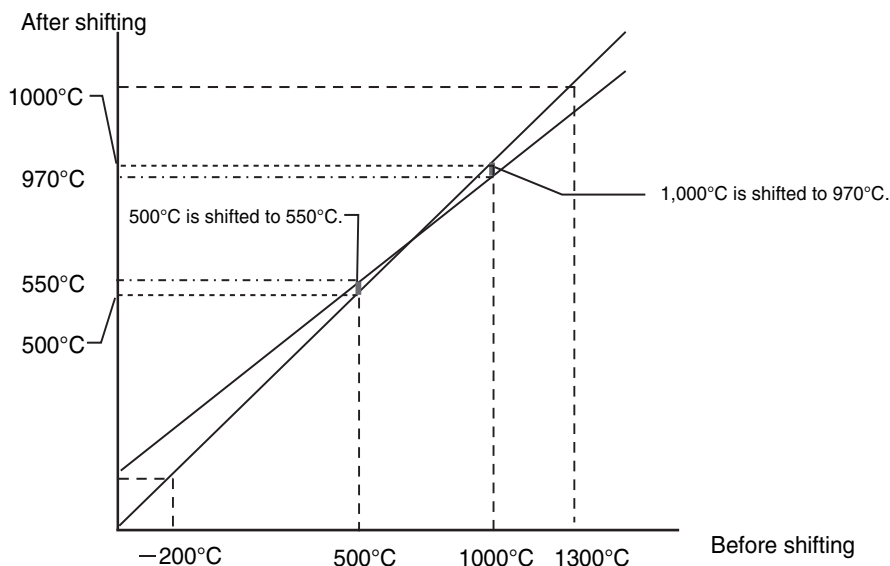

- (1) **Find the two points to shift and determine the PVs after the shifts are applied.**
 Example: Shift 500°C (temperature before shifting) to 550°C (temperature after shifting).
 Example: Shift 1,000°C (temperature before shifting) to 970°C (temperature after shifting).
- (2) **Find the process value slope coefficient from the above results.**

$$(970 - 550) / (1,000 - 500) = 0.840$$
 * Do not yet set the Process Value Slope Coefficient parameter in the Digital Controller.
- (3) **Adjust the PV display on the Digital Controller to the point to be shifted.**
 Example: Adjust the PV to 500°C.
- (4) **Set the Process Value Slope Coefficient parameter to the value that you found in step 2.**
 Example: Set the Process Value Slope Coefficient parameter to 0.840.
- (5) **Read off the PV after the setting is changed.**
 Example: The PV will be displayed as 420°C.
- (6) **Find the difference between the anticipated PV (i.e., the PV after shifting) and the PV that you read off in step 5.**
 Example: $550^{\circ}\text{C} - 420^{\circ}\text{C} = 130^{\circ}\text{C}$
- (7) **Set the Process Value Input Shift parameter to the value that you found in step 6.**
 Example: Set the Process Value Input Shift parameter to 130°C.

5-6 Setting Scaling Upper and Lower Limits for Analog Inputs

● Analog Input

$\bar{L}N-H$	Scaling Upper Limit
$\bar{L}N-L$	Scaling Lower Limit
dP	Decimal Point

- When an analog input is selected, scaling can be performed as needed by the control application.
- Scaling is set in the Scaling Upper Limit, Scaling Lower Limit, and Decimal Point parameters (Initial Setting Level). These parameters cannot be used when a temperature input is selected.
- The Scaling Upper Limit parameter sets the physical quantity to be expressed by the upper limit value of input, and the Scaling Lower Limit parameter sets the physical quantity to be expressed by the lower-limit value of input. The Decimal Point parameter specifies the number of digits below the decimal point.
- The following figure shows a scaling example for a 4 to 20 mA input. After scaling, the temperature can be directly read. Here, one place below the decimal point is set.

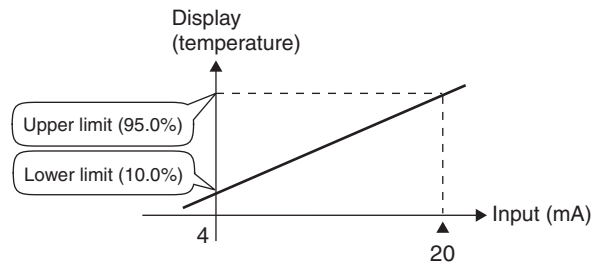

In this example scaling is set to display 4 to 20 mA as 10.0% to 95.0%.

Operating Procedure



- Setting the Input Type

<p>1 Move to the Initial Setting Level. $\bar{L}N-L$ (Input Type) will be displayed.</p>	<p>Initial Setting Level</p> <div style="border: 1px solid black; padding: 5px; display: inline-block;"> $\bar{L}N-L$ 5 </div> <p>Input Type</p>
<p>2 Press the \uparrow or \downarrow Key to set the value to 25. The default is 5.</p>	<div style="border: 1px solid black; padding: 5px; display: inline-block;"> $\bar{L}N-L$ 25 </div>



- Setting the Scaling Upper Limit

<p>1 Press the Ⓢ Key several times in the Initial Setting Level to display $\bar{L}N-H$ (Scaling Upper Limit).</p>	<p>Initial Setting Level</p> <div style="border: 1px solid black; padding: 5px; display: inline-block;"> $\bar{L}N-H$ 100 </div> <p>Scaling Upper Limit</p>
<p>2 Press the \uparrow or \downarrow Key to set the value to 950. The default is 100.</p>	<div style="border: 1px solid black; padding: 5px; display: inline-block;"> $\bar{L}N-H$ 950 </div>

- Setting the Scaling Lower Limit

<p>1 Press the  Key several times in the Initial Setting Level to display $\bar{L}N-L$ (Scaling Lower Limit).</p>	<p>Initial Setting Level</p> <div style="border: 1px solid black; padding: 5px; display: inline-block;"> $\bar{L}N-L$ 0 </div> <p>Scaling Lower Limit</p>
<p>2 Press the  or  Key to set the value to 100. The default is 0.</p>	<div style="border: 1px solid black; padding: 5px; display: inline-block;"> $\bar{L}N-L$ 100 </div>

- Setting the Decimal Point

<p>1 Press the  Key several times in the Initial Setting Level to display dP (Decimal Point).</p>	<p>Initial Setting Level</p> <div style="border: 1px solid black; padding: 5px; display: inline-block;"> dP 0 </div> <p>Decimal Point</p>
<p>2 Press the  or  Key to set the value to 1. The default is 0.</p>	<div style="border: 1px solid black; padding: 5px; display: inline-block;"> dP 1 </div>

5-7 Executing Heating/Cooling Control

5-7-1 Heating/Cooling Control

Heating/cooling control can be used with control output 2 and auxiliary outputs 1 to 4. Heating/cooling control operates when $H-L$ (heating/cooling) is selected for the Standard or Heating/Cooling parameter. The following functions are assigned to outputs in the default status.

Parameter name	Display	Initial status
Control Output 1 Assignment	$\bar{a}Uk1$	Control output for heating
Control Output 2 Assignment (E5ED or E5ED-B only)	$\bar{a}Uk2$	Not assigned.
Auxiliary Output 1 Assignment	$SUb1$	Alarm 1 [*]
Auxiliary Output 2 Assignment	$SUb2$	Alarm 2
Auxiliary Output 3 Assignment (E5ED or E5ED-B only)	$SUb3$	Alarm 3
Auxiliary Output 4 Assignment (E5ED or E5ED-B only)	$SUb4$	Alarm 4

Each output assignment is automatically initialized as shown below when changing between standard and heating/cooling control.

Assigned Output Functions

Two Auxiliary Outputs (E5CD, E5ED, E5CD-B, or E5ED-B)

Parameter name	Display	Allocations	
		Standard	Heating/cooling
Control Output 1 Assignment	$\bar{a}Uk1$	Control output (heating)	Control output (heating)
Auxiliary Output 1 Assignment	$SUb1$	Alarm 1 [*]	Alarm 1 [*]
Auxiliary Output 2 Assignment	$SUb2$	Alarm 2	Control output (cooling)

Four Auxiliary Outputs (E5ED or E5ED-B)

Parameter name	Display	Without control output 2		With control output 2	
		Standard	Heating/cooling	Standard	Heating/cooling
Control Output 1 Assignment	$\bar{a}Uk1$	Control output (heating)	Control output (heating)	Control output (heating)	Control output (heating)
Control Output 2 Assignment	$\bar{a}Uk2$	---	---	Not assigned.	Control output (cooling)
Auxiliary Output 1 Assignment	$SUb1$	Alarm 1 [*]	Alarm 1 [*]	Alarm 1 [*]	Alarm 1 [*]
Auxiliary Output 2 Assignment	$SUb2$	Alarm 2	Alarm 2	Alarm 2	Alarm 2
Auxiliary Output 3 Assignment	$SUb3$	Alarm 3	Alarm 3	Alarm 3	Alarm 3
Auxiliary Output 4 Assignment	$SUb4$	Alarm 4	Control output (cooling)	Alarm 4	Alarm 4

* If the Digital Controller is equipped with HB/HS alarm detection, it is set by default to HA (Heater Alarm). If the Program Pattern parameter is changed to a setting other than OFF, the Auxiliary Output 1 Assignment parameter is set as the program end output.

- The heating/cooling operation of the control outputs will switch when the Direct/Reverse Operation parameter is set to direct operation.

- When DRS (Invert Direct/Reverse Operation) is set for an Event Input Assignment 1 to 6 parameter, control will start with the opposite of the setting of the Direct/Reverse Operation parameter when the event input turns ON. When the event input turns OFF, control will return to operation according to the setting of the Direct/Reverse Operation parameter. For details on event inputs and control combined with the Direct/Reverse Operation parameter, refer to *Control by Inverting Direct/Reverse Operation* on page 5-36.
- If heating/cooling control is selected, also set the Dead Band, Proportional Band (Cooling), Integral Time (Cooling), Derivative Time (Cooling), and Heating/Cooling Tuning Method parameters.

● Dead Band

- For heating/cooling control, the dead band is set with the set point as its center. The dead band width is the set value of the Dead Band parameter (Adjustment Level). Setting a negative value produces an overlapping band.
- If an overlapping band is set, the bumpless function may not operate when switching between manual operation and automatic operation.
- The default is 0.0 EU for Digital Controllers with Temperature Inputs and 0.00% FS for Digital Controllers with Analog Inputs.

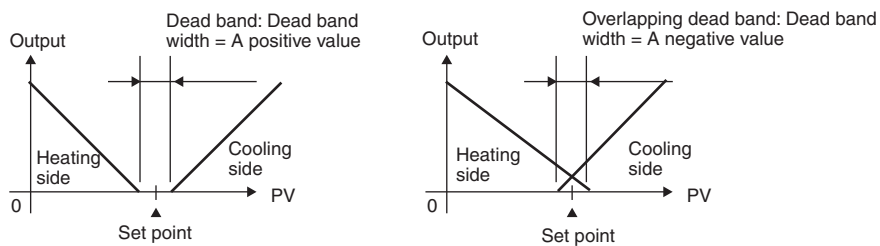

● Heating/Cooling PID Control

If heating/cooling PID control is used, you can set PID control separately for heating and cooling. The PID constants for both heating and cooling can be automatically set according to the cooling control characteristics by setting the Heating/Cooling Tuning Method parameter and then performing autotuning (AT).

Parameter	Setting range	Default	Level
Heating/Cooling Tuning Method	0: Same as heating control	0	Advanced Function Setting Level
	1: Linear		
	2: Air cooling		
	3: Water cooling		

Parameter	Setting range		Unit	Default	Level
Proportional Band (Cooling)	Temperature input	0.1 to 999.9	°C or °F	8.0	Adjustment Level
	Analog input		%FS	10.0	
Integral Time (Cooling)*	Integral/Derivative Time Unit of 1 s	0 to 9999	Seconds	233	
	Integral/Derivative Time Unit of 0.1 s	0.0 to 999.9	Seconds	233.0	
Derivative Time (Cooling)*	Integral/Derivative Time Unit of 1 s	0 to 9999	Seconds	40	
	Integral/Derivative Time Unit of 0.1 s	0.0 to 999.9	Seconds	40.0	

* The unit is determined by the setting of the Integral/Derivative Time Unit parameter. The Proportional Band (Cooling), Integral Time (Cooling), and Derivative Time (Cooling) parameters are initialized if the Integral/Derivative Time Unit parameter is changed.

Air Cooling/Water Cooling Tuning

Control that is suitable for an application that does not have linear cooling characteristics (such as plastic molding machines) is performed. The response is fast and the response characteristics are stable.

Linear Tuning

Control that is suitable for an application that has linear cooling characteristics is performed.

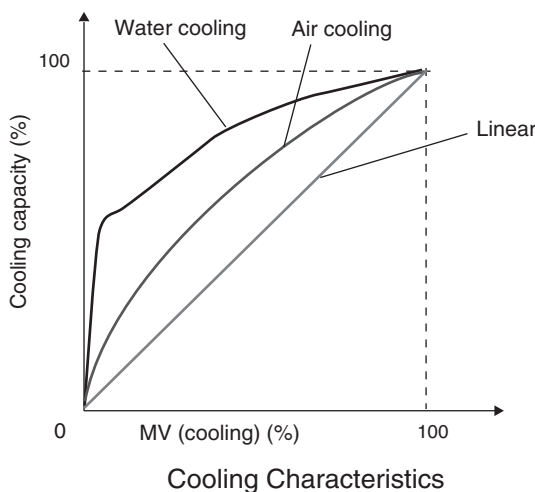

● Water-cooling Output Adjustment

If you set the Heating/Cooling Tuning Method parameter to 3 (Water Cooling), you can use water-cooling output adjustment. We recommend that you perform it in the following cases.

- If the temperature varies due to fluctuations in the cooling system
- If the temperature varies due to changes in the cooling valve settings

For details, refer to *5-2 Automatically Adjusting a Water-cooling Output (for Water-cooled Extruders)*.

● Three-position Control

- Set the PID ON/OFF parameter to $\bar{O}N\bar{O}F$ and set the Standard or Heating/Cooling Parameter to $H-L$ to perform three-position control.
- A dead band (an area where the MV is 0) can be set for either heating or cooling control.

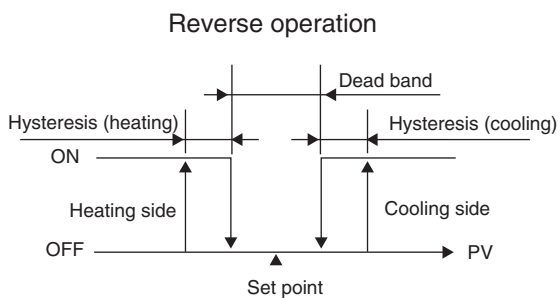

5-8 Using Event Inputs

5-8-1 Event Input Settings

- Events can be used on models that have event inputs.
The number of event inputs that is supported depends on the model of the Digital Controller.
E5CD or E5CD-B: Up to 2 event inputs
E5ED or E5ED-B: Up to 4 event inputs
- Event inputs can be used for switching between RUN and STOP, switching between automatic and manual operation, starting/resetting the program, inverting direct/reverse operation, executing/canceling 100% AT, executing/canceling 40% AT, enabling/disabling setting changes, enabling/disabling communications write, canceling the alarm latch, switching the multi-SP number, PID updating (adaptive control), automatic filter adjustment, and water-cooling output adjustment.

5-8-2 How to Use the Multi-SP Function

The multi-SP function allows you to set up to eight set points (SP 0 to 7) in the Adjustment Level. The set point can be switched by operating the keys on the front panel or by using external input signals (event inputs).

● Using Event Inputs

The following table shows the relationships between the ON/OFF status of multi-SP number switching bits 0 to 2 and the set point.

Selected set point	Multi-SP No. switching bits		
	Bit 0	Bit 1	Bit 2
SP 0	OFF	OFF	OFF
SP 1	ON	OFF	OFF
SP 2	OFF	ON	OFF
SP 3	ON	ON	OFF
SP 4	OFF	OFF	ON
SP 5	ON	OFF	ON
SP 6	OFF	ON	ON
SP 7	ON	ON	ON

Note: Any bits that are not assigned to event inputs are treated as being OFF.

● Using Key Operations

You can select any of the set points 0 to 7 by changing the set value of the Multi-SP Uses parameter. The Multi-SP Uses parameter display conditions are as follows:

- Digital Controllers without event inputs for which the Number of Multi-SP Points parameter is not set to OFF
- Controllers with event inputs for which the Number of Multi-SP Points parameter is not set to OFF and the Event Input Assignment 1 to 6 parameters are not set to Multi-SP switching bits 0 to 2

The following table shows the relationship between the Multi-SP Uses parameter set value and the selected set point

Multi-SP	Selected set point
0	SP 0
1	SP 1
2	SP 2
3	SP 3
4	SP 4
5	SP 5
6	SP 6
7	SP 7

Note: The set point can also be switched using communications.

5-8-3 Operation Commands Other than Multi-SP

The following table shows the functions that can be assigned when an Event Input Assignment 1 or 6 parameter is displayed.

Setting	Function	Detection method ^{*5}
<i>NONE</i>	None	---
<i>STOP</i>	RUN/STOP	Edge
<i>MANU</i>	Auto/Manual ^{*4}	Level
<i>PRST</i>	Program Start ^{*1}	Level
<i>DRS</i>	Invert Direct/Reverse Operation	Level
<i>NONE</i>	None	---
<i>AT-2</i>	100% AT Execute/Cancel	Edge
<i>AT-1</i>	40% AT Execute/Cancel ^{*2}	Edge
<i>WPEL</i>	Setting Change Enable/Disable	Level
<i>CMWE</i>	Communications Write Enable/Disable ^{*3}	Level
<i>LAL</i>	Alarm Latch Cancel	Edge
<i>MSP0</i>	Multi-SP No. switching bit 0	Edge
<i>MSP1</i>	Multi-SP No. switching bit 1	Edge
<i>MSP2</i>	Multi-SP No. switching bit 2	Edge
<i>RUN</i>	STOP/RUN	Edge
<i>R-UD</i>	PID Update (Adaptive Control)	Edge
<i>FA</i>	Automatic Filter Adjustment	Edge
<i>W-HL</i>	Water-cooling Output Adjustment	Edge

*1 PRST (Program Start) can be set even when the Program Pattern parameter is set to OFF, but the function will be disabled.

*2 This function can be set for heating/cooling control, but the function will be disabled.

*3 This function can be set only for a Controller that supports communications. Also, when a work bit is selected as the event input data for a logic operation, Communications Write Enable/Disable cannot be assigned. If the Digital Controller is operating only on the power supply from the USB-Serial Conversion Cable, it will operate as if the event inputs remain OFF. Therefore, communications writing will be disabled and you will not be able to write data from Setup Tools, such as the CX-Thermo.

*4 If the same function is assigned to PF Key, it will be disabled for the PF Key and only the event input can be used to execute the function.

*5 For edge detection, the function will operate only when the status of the event input changes. Edges will be detected for edge-detection events when the power supply is turned ON.

Turn event inputs ON and OFF while the power is being supplied. Event input ON/OFF changes are detected for inputs of 50 ms or longer.

The functions are described in detail below.

● Executing Run/Stop Control

When the Event Input Assignment parameter is set to STOP (RUN/STOP), control is started when event input turns OFF. Control is stopped when the input turns ON. However, alarms will operation regardless of the run/stop status.

The STOP indicator will light while control is stopped.

Setting	Input contact	Status
Event input	ON	STOP
Event input	OFF	RUN

Set the Event Input Assignment parameter to RUN (RUN/STOP) for the reverse logic.

Setting	Input contact	Status
Event input	ON	RUN
Event input	OFF	STOP

● Switching between Auto and Manual Control

When the Event Input Assignment parameter is set to MANU (auto/manual), manual control will start when event input turns ON. Auto control will start when the input turns OFF.

The MANU indicator will light during manual control.

Setting	Input contact	Status
Event input	OFF	Automatic
Event input	ON	Manual

● Controlling the Start of the Simple Program Function

When the Event Input Assignment parameter is set to PRST (program start), the program will start when the event input turns ON. The program will be reset when the input turns OFF and the RUN/STOP status will automatically switch to STOP mode. If the program END output is ON, the program END output will turn OFF.

Setting	Input contact	Status
Event input	OFF	Reset
Event input	ON	Start

● Control by Inverting Direct/Reverse Operation

When the Event Input Assignment parameter is set to DRS (Invert Direct/Reverse Operation) and the Direct/Reverse Operation parameter is set for reverse operation, control starts with direct operation (cooling control) when the event input turns ON and control starts with reverse operation (heating control) when the event input turns OFF.

Setting	Input contact	Direct/Reverse Operation parameter	Status
Event input	OFF	Direct operation (cooling)	Direct operation (cooling)
		Reverse operation (heating)	Reverse operation (heating)
Event input	ON	Direct operation (cooling)	Reverse operation (heating)
		Reverse operation (heating)	Direct operation (cooling)

● Switching 100% AT Execute/Cancel

When the Event Input Assignment parameter is set to AT-2 (100% AT Execute/Cancel), 100% AT will be executed when the event input turns ON and will be cancelled when the input turns OFF.

Setting	Input contact	Status
Event input	OFF	100% AT cancelled
Event input	ON	100% AT executed

● Switching 40% AT Execute/Cancel

When the Event Input Assignment parameter is set to AT-1 (40% AT Execute/Cancel), 40% AT will be executed when the event input turns ON and will be cancelled when the input turns OFF.

Setting	Input contact	Status
Event input	OFF	40% AT cancelled
Event input	ON	40% AT executed

● Switching Setting Change Enable/Disable

When the Event Input Assignment parameter is set to WTPT (Setting Change Enable/Disable), the setting change will be disabled when the event input turns ON and will be enabled when the input turns OFF.

Setting	Input contact	Status
Event input	OFF	Enabled
Event input	ON	Disabled

● Switching Communications Write Enable/Disable

When the Event Input Assignment parameter is set to CMWT (Setting Change Enable/Disable), writing with communications will be enabled when the event input turns ON and writing with communications will be disabled when the event input turns OFF.

Setting	Input contact	Status
Event input	OFF	Disabled
Event input	ON	Enabled

● Switching Alarm Latch Cancel

When the Event Input Assignment parameter is set to LAT (Alarm Latch Cancel), all alarm latches (alarms 1 to 4, heater burnout, HS alarm, latch) will be cancelled when event input turns ON.

Setting	Input contact	Status
Event input	OFF	---
Event input	ON	Cancelled

● Performing PID Update (Adaptive Control)

When the Event Input Assignment parameter is set to A-UD (PID Update), updating PID constants for adaptive control is started when the event input turns ON.

Setting	Input contact	Status
Event input	OFF	---
Event input	ON	Updated

● Performing Automatic Filter Adjustment

When the Event Input Assignment parameter is set to FA (Automatic Filter Adjustment), automatic filter adjustment is performed when the event input turns ON. It will be cancelled when the event input turns OFF.

Setting	Input contact	Status
Event input	OFF	Automatic filter adjustment cancelled.
Event input	ON	Automatic filter adjustment performed.

● Water-cooling Output Adjustment

When the Event Input Assignment parameter is set to W-HT (Water-cooling Output Adjustment), water-cooling output adjustment will be enabled when the event input turns ON.

Setting	Input contact	Status
Event input	OFF	Disabled.
Event input	ON	Enabled.

Parameters

Display	Parameter	Description	Level
<i>EV-1</i>	Event Input Assignment 1	Function of event input	Initial Setting Level
<i>EV-2</i>	Event Input Assignment 2		Initial Setting Level
<i>EV-3</i>	Event Input Assignment 3		Initial Setting Level
<i>EV-4</i>	Event Input Assignment 4		Initial Setting Level
<i>EV-5</i>	Event Input Assignment 5		Initial Setting Level
<i>EV-6</i>	Event Input Assignment 6		Initial Setting Level
<i>MSPU</i>	Number of Multi-SP Points		Advanced Function Setting Level

5-9 Setting the SP Upper and Lower Limit Values

5-9-1 Set Point Limiter

The setting range of the set point is limited by the set point limiter. This function can be used to prevent setting incorrect set points. The upper- and lower-limit values of the set point limiter are set using the Set Point Upper Limit and Set Point Lower Limit parameters in the Initial Setting Level. If the set point is not within the range set for the set point limiter as the result of changes to the Set Point Upper Limit or Set Point Lower Limit parameter, the set point will automatically be changed to a value within the set range. When the set point limiter is reset, the set point is forcibly changed to the upper- or lower-limit value of the set point limiter if the set point is out of the limiter range. Also, when the input type and the temperature unit, scaling upper-limit value, or lower-limit value are changed, the set point limiter is forcibly reset to the input setting range or the scaling upper- or lower-limit value.

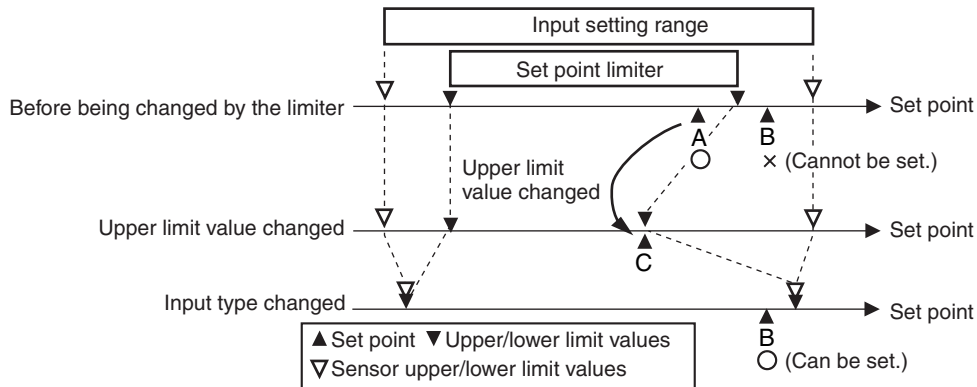

Parameters

Parameters	Parameter	Description	Level
SL-H	Set Point Upper Limit	To limit the SP setting	Initial Setting Level
SL-L	Set Point Lower Limit	To limit the SP setting	Initial Setting Level

5-9-2 Setting

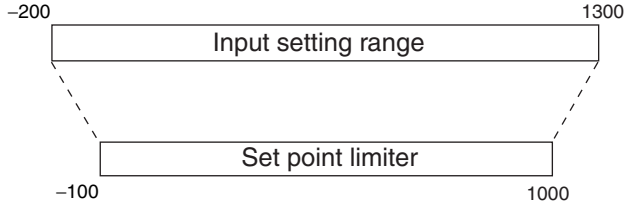

Set the set point upper and lower limits in the Set Point Upper Limit and Set Point Lower Limit parameters in the Initial Setting Level. In this example, it is assumed that the input type is set to a K thermocouple with a temperature range of -200 to 1300°C.





Set the upper and lower limits for the set point.
 Set Point Upper Limit = 1000
 Set Point Lower Limit = -100

Operating Procedure

- Setting the Set Point Upper Limit

<p>1 Press the  Key several times in the Initial Setting Level to display 5L-H (Set Point Upper Limit).</p>	<p>Initial Setting Level</p> <div style="border: 1px solid black; padding: 5px; display: inline-block;"> <p>5L-H 1300</p> </div> <p>Set Point Upper-limit</p>
<p>2 Press the  or  Key to set the value to 1000. The default is 1300.</p>	<div style="border: 1px solid black; padding: 5px; display: inline-block;"> <p>5L-H 1000</p> </div>

- Setting the Set Point Lower Limit

<p>1 Press the  Key several times in the Initial Setting Level to display 5L-L (Set Point Lower Limit).</p>	<p>Initial Setting Level</p> <div style="border: 1px solid black; padding: 5px; display: inline-block;"> <p>5L-L -200</p> </div> <p>Set Point Lower Limit</p>
<p>2 Press the  or  Key to set the value to -100. The default is -200.</p>	<div style="border: 1px solid black; padding: 5px; display: inline-block;"> <p>5L-L -100</p> </div>

5-10 Using the SP Ramp Function to Limit the SP Change Rate

5-10-1 SP Ramp

The SP ramp function is used to restrict the width of changes in the set point as a rate of change. When the SP ramp function is enabled and the change width exceeds the specified rate of change, an area where the set point is restricted will be created, as shown in the following diagram.

During the SP ramp, control will be performed not for the specified set point but rather for the set point restricted by the rate of change set for the SP ramp function.

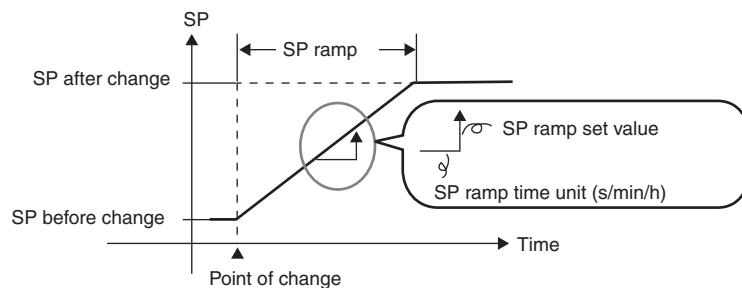

The rate of change during an SP ramp is specified using the SP Ramp Set Value, SP Ramp Fall Value, and SP Ramp Time Unit parameters. The SP Ramp Set Value parameter is set to OFF by default and the SP Ramp Fall Value parameter is set to SAME by default, i.e., the SP ramp function is disabled.

Changes in the ramp set point can be monitored in the Set Point During SP Ramp parameter (Operation Level). Use this parameter when monitoring SP ramp operation.

The SP ramp function operates in the same way when switching the set point using the multi-SP function.

Parameters

Display	Parameter	Description	Level
<i>SPRL</i>	SP Ramp Set Value	To limit the SP rate of change	Adjustment Level
<i>SPRL</i> MASK8	SP Ramp Fall Value	To limit the SP rate of change	Adjustment Level
<i>SPRU</i>	SP Ramp Time Unit	Unit for setting the SP	Advanced Function Setting Level
<i>RLSP</i> MASK8	Alarm SP Selection	Alarm SP selection	Advanced Function Setting Level

● Operation at Startup

If the SP ramp function is enabled when the Digital Controller is turned ON or when switching from STOP to RUN mode, the process value reaches the set point using the SP ramp function in the same way as when the set point is changed. In this case, operation is carried out with the process value treated as the set point before the change was made. The direction of the SP ramp changes according to the relationship between the process value and the set point.

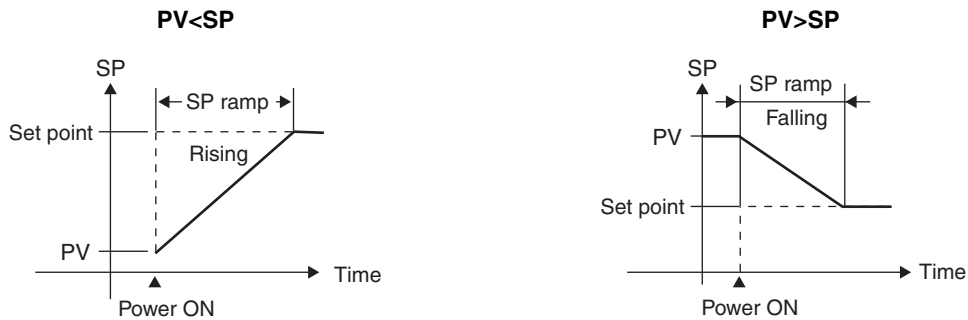

● Restrictions during SP Ramp Operation

- Execution of auto-tuning starts after the end of the SP ramp.
- When control is stopped or an error occurs, the SP ramp function is disabled.

● Alarms during SP Ramp Operation

The operation of alarms during SP ramp operation depends on whether alarms are set to be based on the ramp set point or the target set point (refer to the following diagrams). The set point to be used is set in the Alarm SP Selection parameter.

Alarm SP Selection = Ramp SP (Alarm Type: 1 (Upper/Lower Limits))

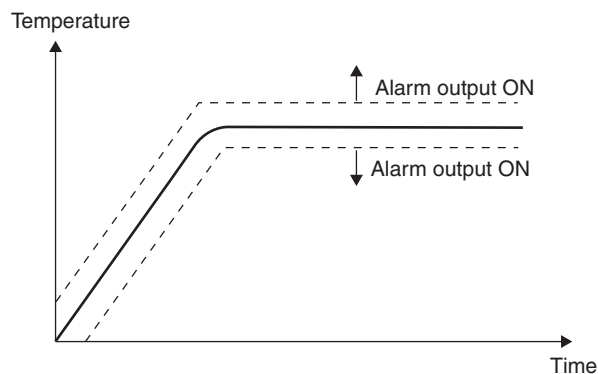

Alarm SP Selection = Target SP (Alarm Type: 1 (Upper/Lower Limits))

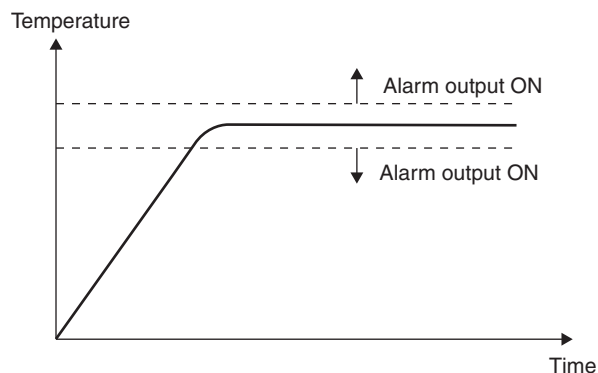

5-11 Using the Key Protect Level

5-11-1 Protection

- To move to the Protect Level, press the ⏏ and ⏏ Keys simultaneously for at least three seconds in Operation Level or Adjustment Level.*
 - * The key pressing time can be changed in the Move to Protect Level Time parameter (Advanced Function Setting Level).
- The Protect Level protects parameters that are not changed during Digital Controller operation until operation is started to prevent them from being modified unintentionally. There are four types of protection: operation/adjustment protect, initial setting/communications protect, setting change protect, and PF Key protect.
- The protect level settings restrict the range of parameters that can be used.

● Operation/Adjustment Protect

Displaying and changing settings in Operation Level and moving to Adjustment Level are restricted. The following table shows the relationship between set values and the range of protection.

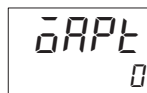

Level		Set value			
		0	1	2	3
Operation Level	PV	Can be displayed	Can be displayed	Can be displayed	Can be displayed
	PV/SP	Can be displayed and changed	Can be displayed and changed	Can be displayed and changed	Can be displayed
	Others	Can be displayed and changed	Can be displayed and changed	Cannot be displayed and moving to other levels is not possible	Cannot be displayed and moving to other levels is not possible
Adjustment Level		Can be displayed and changed	Cannot be displayed and moving to other levels is not possible	Cannot be displayed and moving to other levels is not possible	Cannot be displayed and moving to other levels is not possible

- Parameters are not protected when the set value is set to 0.
- The default is 0.

● Initial Setting/Communications Protect

This protect level restricts movement to the Initial Setting Level, Communications Setting Level, and Advanced Function Setting Level.



Set value	Initial Setting Level	Communications Setting Level	Advanced Function Setting Level
0	Possible to reach	Possible to reach	Possible to reach
1	Possible to reach	Possible to reach	Not possible to reach
2	Not possible to reach	Not possible to reach	Not possible to reach

- The default is 1.

Application Example: To enable setting only the SP, set both the Operation/Adjustment Protect parameter and the Initial Setting/Communications Protect parameter to 2.

● **Setting Change Protect**

This protect level restricts key operations

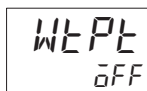

Set value	Description
OFF	Settings can be changed using key operations.
ON	Settings cannot be changed using key operations. (The protect level settings, however, can be changed.)

- The default is OFF.
- The setting change protection indicator (On) will light when the Setting Change Protect parameter is set to ON.

● **PF Key Protect**

This protect level enables or disables PF Key operations.

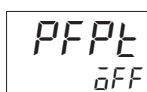

Set value	Description
OFF	PF Key enabled.
ON	PF Key disabled (Operation as function key prohibited).

- The default is OFF.

5-11-2 Entering the Password to Move to the Protect Level

- The Protect Level can be moved to only by displaying the password display and entering the correct password. (The user can set any password in the Password to Move to Protect Level parameter.) If no password is set (i.e., if the password is set to 0 in the Password to Move to Protect Level parameter), the password input display to move to the Protect Level will not be displayed and the Protect Level can be moved to directly.

Move to the Protect Level and set the password.

Example password: 1234

Operating Procedure



● **Password Not Yet Set**

<p>1 Press the and Keys simultaneously for at least 3 seconds (default) in the Operation Level.*¹ If a password is not set, the Protect Level will be entered and <i>OPPL</i> (Operation/Adjustment Protect) will be displayed.</p>	<p>Protect Level</p> <p>Operation/Adjustment Protect</p>
<p>2 Press the Key several times in the Protect Level to display <i>PRLP</i> (Password to Move to Protect Level).</p>	<p>Password to Move to Protect Level</p> <p>MASK8</p>
<p>3 Press the and Keys simultaneously and set the value to 1234. (This enters the password.) To prevent setting the password incorrectly, the and Keys or and Keys must be pressed simultaneously to set the password.</p>	<p>MASK8</p>



*1 The key pressing time can be changed in *PRLT* (Move to Protect Level Time) in the Advanced Function Setting Level. (Setting range: 1 to 30 seconds, Default: 3 seconds)

● Password Already Set

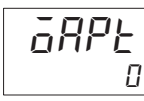
- Deleting the Password (Password Deletion Example: 5678)

<p>1 Press the and Keys simultaneously for at least 3 seconds (default) in the Operation Level.*1 <i>PMōV</i> (Move to Protect Level) will be displayed.</p>	<p>Protect Level</p>  <p>Move to Protect Level</p>
<p>2 Press the or Key to set the password to 5678. (This enters the password.)</p>	
<p>3 Move to the Operation/Adjustment Protect parameter in the Protect Level by pressing the or Key or leaving the setting for at least two seconds. (This deletes the password.)</p>	 <p>Operation/Adjustment Protect</p>

- Setting the Password Again (Password Example: 1234)

<p>1 Set the password to 1234 again. Press the Key several times in the Protect Level to display <i>PRLP</i> (Password to Move to Protect Level).</p>	 <p>Password to Move to Protect Level</p> <p>MASK8</p>
<p>2 Press the and Keys simultaneously and set the value to 1234. (This enters the password.) To prevent setting the password incorrectly, the and Keys or and Keys must be pressed simultaneously to set the password.</p>	 <p>MASK8</p>

*1 The key pressing time can be changed in *PRLT* (Move to Protect Level Time) in the Advanced Function Setting Level. (Setting range: 1 to 30 seconds, Default: 3 seconds)



Precautions for Correct Use

Protection cannot be cleared or changed without the password. Be careful not to forget it. If you forget the password, contact your OMRON sales representative.

● Communications Operation Command to Move to the Protect Level

- The Write Variable operation command can be used via communications to write the password to the Move to Protect Level parameter. When the correct password is written, the display will change to the Operation/Adjustment Protect parameter and writing the parameters in the Protect Level will be enabled.

Note 1: If the Write Variable operation command is used to write the wrong password to the Move to Protect Level parameter after the correct parameter has been written, the Move to Protect Level parameter will be displayed and any Write Variable operation commands to write parameters in the Protect Level will result in operation errors.

2: If a password is not set or if it is set to 0, the display will change to the Operation/Adjustment Protect parameter and writing the parameters in the Protect Level will be enabled immediately.

5-12 Hiding and Displaying Parameters

5-12-1 Parameter Mask Setting

You can use a key operation to hide parameters that do not need to be displayed. This allows you to prevent incorrect settings for parameters or to simplify the parameter configuration according to the application.

● Parameters

Display	Parameter	Description	Level
<i>PMSL</i>	Parameter Mask Setting	Moves you to the Parameter Mask Mode.	Advanced Function Setting Level
<i>PMSK</i>	Parameter Mask Enable	Enables and disables parameter masks.	Protect Level

● Description

- If you set the Parameter Mask Setting parameter (Advanced Function Setting Level) to ON, Parameter Mask Mode is entered.
- When you enter Parameter Mask Mode, the first parameter in the Operation Level is displayed.
- When you press the \ominus Key, the setting level changes as shown below.

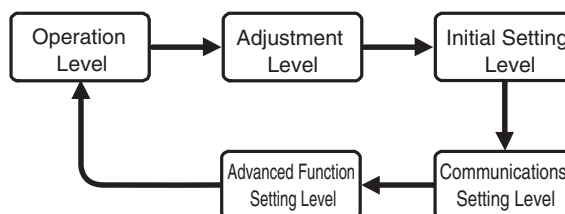

- * You cannot mask parameters in the Manual Control Level, Monitor/Setting Item Level, and Protect Level.
- Press the \ominus Key once for less than one second to move to the next parameter in the current setting level.
Press the \ominus Key for at least one second to move to the previous parameter in the current setting level.
- Press the \uparrow or \downarrow Key to set the parameter to *DISP* (disable mask (show)) or *MASK* (enable mask (hide)).
- Perform one of the following operations to end Parameter Mask Mode.
 1. Cycle the power supply.
 2. Send a Software Reset command with communications.
 3. Press the \ominus Key for at least 1 s.
- When you enter Parameter Mask Mode, the first parameter in the Operation Level is displayed. However, you cannot set a parameter mask for the Process Value/Set Point 1 and Process Value/Set Point 2 parameters.
- **Some parameters are masked (mask: mask enable (hidden)) in the default Parameter Mask Settings. These parameters are indicated with the **MASK** mark.**
 - Auto/Manual Switch (Operation Level)
 - MV Monitor (Heating) (Operation Level)
 - MV Monitor (Cooling) (Operation Level)
 - MV at Stop (Adjustment Level)
 - MV at PV Error (Adjustment Level)

Other than the above parameters, the **MASK8** mark appears for parameters that are masked only for the E5□D-□-8□□.



Masking (Hiding) Parameters

● Setting Example

In this example, the Temperature Input Shift parameter in the Adjustment Level is set to *MASK* (enable mask (hide)).





Operating Procedure

- Moving to Parameter Mask Mode (Advanced Function Setting Level)

<p>1 Press the  Key several times in the Advanced Function Setting Level to display the Parameter Mask Setting parameter.</p>	<p>Advanced Function Setting Level</p> <div style="display: flex; align-items: center;"> <div style="border: 1px solid black; padding: 5px; margin-right: 10px;"> <p style="margin: 0;">PMSL OFF</p> </div> <div> <p>Parameter Mask Setting</p> </div> </div>
<p>2 Press the  or  Key to set the parameter to <i>ON</i> (Move to Parameter Mask Mode). The default is <i>OFF</i>.</p>	<div style="border: 1px solid black; padding: 5px;"> <p style="margin: 0;">PMSL ON</p> </div>



Refer to 4-1-4 Moving to the Advanced Function Setting Level for information on entering the Advanced Function Setting Level.

- Hiding the SP Mode Parameter (Adjustment Level)

<p>1 Press the  Key several times in the Adjustment Level to select the Temperature Input Shift parameter.</p>	<p>Adjustment Level</p> <div style="display: flex; align-items: center;"> <div style="border: 1px solid black; padding: 5px; margin-right: 10px;"> <p style="margin: 0;">TNS dLSP</p> </div> <div> <p>Temperature Input Shift</p> </div> </div>
<p>2 Press the  or  Key to set the parameter to <i>MASK</i> (enable mask (hide)). The default is <i>dLSP</i>.</p>	<div style="border: 1px solid black; padding: 5px;"> <p style="margin: 0;">TNS MASK</p> </div>
<p>3 Press the  Key for at least one second to end Parameter Mask Mode.</p>	

Refer to 4-1-2 Moving to the Adjustment Level for information on entering the Adjustment Level.

- Enabling Parameter Masks (Protect Level)



<p>1 Press the  Key several times in the Protect Level to display the Parameter Mask Enable parameter.</p>	<p>Protect Level</p> <div style="display: flex; align-items: center;"> <div style="border: 1px solid black; padding: 5px; margin-right: 10px;"> <p style="margin: 0;">PMSK ON</p> </div> <div> <p>Parameter Mask Enable</p> </div> </div>
<p>2 Press the  or  Key to set the parameter to <i>ON</i> (enable). The default is <i>ON</i>.</p>	<div style="border: 1px solid black; padding: 5px;"> <p style="margin: 0;">PMSK ON</p> </div>

* The Temperature Input Shift parameter is masked (i.e., hidden).

Refer to 4-1-2 Moving to the Adjustment Level for information on entering the Protect Level.

Unmasking (Displaying) Parameters

- Disabling Parameter Masks (Displaying) (Protect Level)

<p>1 Press the  Key several times in the Protect Level to display the Parameter Mask Enable parameter.</p>	<p>Protect Level</p> <div style="border: 1px solid black; padding: 5px; display: inline-block;"> <p>PMSK ON</p> </div> <p>Parameter Mask Enable</p>
<p>2 Press the  or  Key to set the parameter to OFF (Disable). The default is ON.</p>	<div style="border: 1px solid black; padding: 5px; display: inline-block;"> <p>PMSK OFF</p> </div>

5-13 OR Output of Alarms

5-13-1 Integrated Alarm

You can use an integrated alarm to output an OR of alarms 1 to 4, the HB alarm, the HS alarm, and the input error. Set the Integrated Alarm Assignment parameter (*ALM*) and then assign the integrated alarm (*ALM*) to an auxiliary output or a control output.

● Parameters

Parameter	No. 1 display	Value	No. 2 display	Level
Control Output Assignment	<i>OUT 1</i> to <i>OUT 2</i>	ALM: Integrated alarm (The Integrated Alarm Assignment parameter must be set separately.)	<i>ALM</i>	Advanced Function Setting Level
Auxiliary Output 1 to 4 Assignment	<i>SUB 1</i> to <i>SUB 4</i>	ALM: Integrated alarm (The Integrated Alarm Assignment parameter must be set separately.)	<i>ALM</i>	Advanced Function Setting Level
Integrated Alarm Assignment	<i>ALM</i>	Set the sum of the following values for the alarms and errors to include in the OR output. 0 to 255 Alarm 1: +1 Alarm 2: +2 Alarm 3: +4 Alarm 4: +8 HB alarm: +16 HS alarm: +32 Input error: +64 (Default: 49 (i.e., an OR of alarm 1, the HB alarm, and the HS alarm))	0 to 255	Advanced Function Setting Level

● Operating Procedure







The following procedure outputs an OR of the following alarms on auxiliary output 2.

- Alarm 1
- HB alarm (*Hb*)

The settings are made in the Advanced Function Setting Level.

Operating Procedure

- Assigning the Integrated Alarm to an Auxiliary Output

<p>1 Press the  Key several times in the Advanced Function Setting Level to display <i>SUB2</i> (Auxiliary Output 2 Assignment).</p>	<p>Advanced Function Setting Level</p> <div style="border: 1px solid black; padding: 5px; display: inline-block;"> <p><i>SUB2</i> <i>ALM2</i></p> </div> <p>Auxiliary Output 2 Assignment</p>
<p>2 Press the  or  Key to select <i>ALM</i> (Integrated Alarm). The default is <i>ALM2</i> (Alarm 2).</p>	<div style="border: 1px solid black; padding: 5px; display: inline-block;"> <p><i>SUB2</i> <i>ALM</i></p> </div>
<ul style="list-style-type: none"> • Setting the Integrated Alarm Assignment Parameter 	
<p>1 Press the  Key several times in the Advanced Function Setting Level to display <i>ALMA</i> (Integrated Alarm Assignment).</p>	<p>Advanced Function Setting Level</p> <div style="border: 1px solid black; padding: 5px; display: inline-block;"> <p><i>ALMA</i> 49</p> </div> <p>Integrated Alarm Assignment</p>
<p>2 Press the  or  Key to set the set value to 17 (i.e., the sum of 1 for alarm 1 and 16 for the HB alarm). The default is 49. (Alarm 1 (1) + HB alarm (16) + HS Alarm (32)= 49)</p>	<div style="border: 1px solid black; padding: 5px; display: inline-block;"> <p><i>ALMA</i> 17</p> </div>



Additional Information

For details on the integrated alarm, refer to *Section 6 Parameters*.

5-14 Alarm Delays

5-14-1 Alarm Delays

- Delays can be set for the alarm outputs. ON and OFF delays can be set separately for alarms 1, 2, 3, and 4. The ON and OFF delays for alarms 1, 2, 3, and 4 also apply to the individual SUB1, SUB2, SUB3, and SUB4 indicators and to communications status. The alarm ON delays will also function when power is turned ON or when moving from the Initial Setting Level to Operation Level (e.g., to software resets). All outputs will turn OFF and the OFF delays will not function when moving to the Initial Setting Level or when an alarm is output for an A/D converter error.

● Operation of Alarm ON and OFF Delays (for an Upper-limit Alarm)

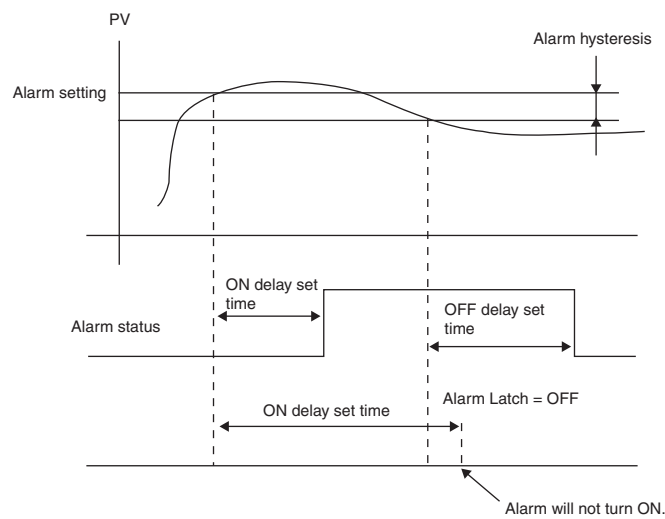

- The alarm will not turn ON if the time that the alarm is ON is equal to or less than the ON delay set time. Also, the alarm will not turn OFF if the time that the alarm is OFF is equal to or less than the OFF delay set time.
- If an alarm turns OFF and then back ON during the ON delay time, the time will be remeasured from the last time the alarm turns ON. Also, if an alarm turns ON and then back OFF during the OFF delay time, the time will be remeasured from the last time the alarm turns OFF.

● Parameters Related to Alarm Delays

Parameter name	Display	Set (monitor) values	Level
Alarm 1 ON Delay	R1 $\bar{O}N$	0 to 999 (s)	Advanced Function Setting Level
Alarm 2 ON Delay	R2 $\bar{O}N$	0 to 999 (s)	
Alarm 3 ON Delay	R3 $\bar{O}N$	0 to 999 (s)	
Alarm 4 ON Delay	R4 $\bar{O}N$	0 to 999 (s)	
Alarm 1 OFF Delay	R1 $\bar{O}F$	0 to 999 (s)	
Alarm 2 OFF Delay	R2 $\bar{O}F$	0 to 999 (s)	
Alarm 3 OFF Delay	R3 $\bar{O}F$	0 to 999 (s)	
Alarm 4 OFF Delay	R4 $\bar{O}F$	0 to 999 (s)	



Note 1: The defaults are 0, i.e., the ON and OFF delays are disabled.

Note 2: The parameters are displayed when alarm functions are assigned and when the alarm type is set to any type but 0 (none), 12: LBA, or 13: PV change rate alarm.

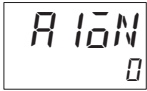

Use the following procedure to set ON and OFF delays for the alarm 1.
An ON delay of 5 seconds and an OFF delay of 10 s will be set.

Operating Procedure

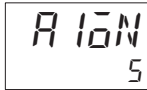
- Setting the Alarm 1 ON Delay

<p>1 Press the  Key several times in the Advanced Function Setting Level to display <i>A lōN</i> (Alarm 1 ON Delay).</p>	<p>Advanced Function Setting Level</p>  Alarm 1 ON Delay
<p>2 Press the  or  Key to set the value to 5. The default is 0.</p>	

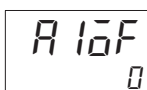
- Setting the Alarm 1 OFF Delay

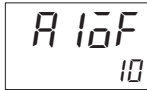
<p>1 Press the  Key several times in the Advanced Function Setting Level to display <i>A lōF</i> (Alarm 1 OFF Delay).</p>	<p>Advanced Function Setting Level</p>  Alarm 1 OFF Delay
<p>2 Press the  or  Key to set the value to 10. The default is 0.</p>	

5-15 Loop Burnout Alarm

5-15-1 Loop Burnout Alarm (LBA)

- With a loop burnout alarm, there is assumed to be an error in the control loop if the control deviation (SP - PV) is greater than the threshold set in the LBA Level parameter and if the control deviation is not reduced by at least the value set in the LBA Detection Band parameter within the LBA detection time.
- Loop burnout alarms are detected at the following times.

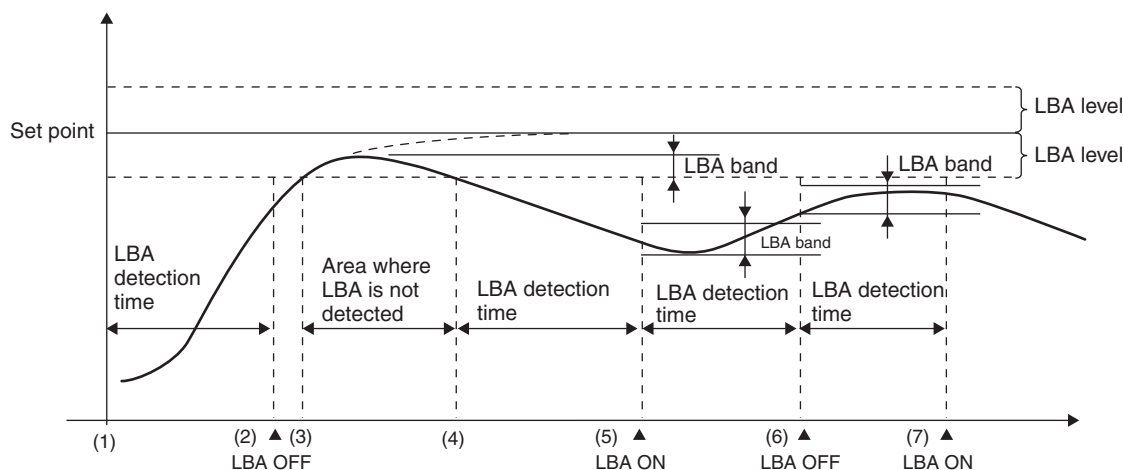

If the control deviation is reduced in the area between 1 and 2 (i.e., the set point is approached) and the amount the control deviation is reduced is at least equal to the LBA band, the loop burnout alarm will remain OFF.

The process value is within the LBA level between 3 and 4, and thus loop burnout alarms will not be detected. (The loop burnout alarm will remain OFF.)

If the process value is outside the LBA level between 4 and 5 and the control deviation is not reduced by at least the LBA band within the LBA detection time, the loop burnout alarm will turn ON. If the control deviation is reduced in the area between 5 and 6 (i.e., the set point is approached) and the amount the control deviation is reduced is at least equal to the LBA band, the loop burnout alarm will turn OFF.

If the control deviation is reduced in the area between 6 and 7 (i.e., the set point is approached) and the amount the control deviation is reduced is less than the LBA band, the loop burnout alarm will turn ON.

- If the LBA detection time, LBA level, LBA detection band, and PID settings are not appropriate, alarms may be detected inappropriately or alarms may not be output when necessary.
- Loop burnout alarms may be detected if unexpectedly large disturbances occur continuously and a large deviation does not decrease.
- If a loop burnout occurs when the set point is near the ambient temperature, the temperature deviation in a steady state may be less than the LBA level, preventing detection of the loop burnout.
- If the set point is so high or low that it cannot be reached even with a saturated manipulated variable, a temperature deviation may remain even in a steady state and a loop burnout may be detected.
- Detection is not possible if a fault occurs that causes an increase in temperature while control is being applied to increase the temperature (e.g., an SSR short-circuit fault).

- Detection is not possible if a fault occurs that causes a decrease in temperature while control is being applied to decrease the temperature (e.g., a heater burnout fault).

● **Parameters Related to Loop Burnout Alarms**

Parameter name	Display	Setting range		Remarks	Level
LBA Detection Time	<i>LbR</i>	0 to 9999 (s)		Setting 0 disables the LBA function.	Advanced Function Setting Level
LBA Level	<i>LbRL</i>	Temperature input	0.1 to 999.9 (°C/°F)	Default: 8.0 (°C/°F)	
		Analog input	0.01 to 99.99 (%FS)	Default: 10.00% FS	
LBA Band	<i>LbRb</i>	Temperature input	0.0 to 999.9 (°C/°F)	Default: 3.0 (°C/°F)	
		Analog input	0.00 to 99.99 (%FS)	Default: 0.20% FS	

- A loop burnout alarm can be output by setting the alarm 1 type to 12 (LBA).
- A setting of 12 (LBA) can be set for alarms 2 to 4, but the setting will be disabled.
- Loop burnouts are not detected during SP ramp operation.
- Loop burnouts are not detected during auto-tuning, manual operation, or while stopped.
- If the alarm 1 latch is set to ON, the latch will be effective for the loop burnout alarm.

● **Automatically Setting the LBA Detection Time**

- The LBA detection time is automatically set by auto-tuning. (It is not set automatically, however, for heating/cooling control.)
- If the optimum LBA detection time is not obtained by auto-tuning, set the LBA Detection Time parameter (Advanced Function Setting Level).

● **Determining the LBA Detection Time**

- To manually set the LBA detection time, set the LBA Detection Time parameter to twice the LBA reference time given below.

(1) **Set the output to the maximum value.**

(2) **Measure the time required for the width of change in the input to reach the LBA band.**

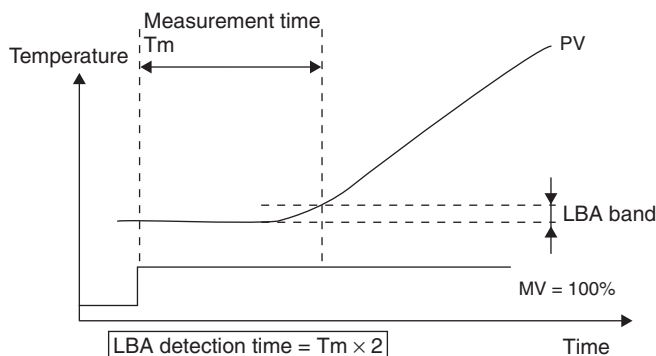

(3) **Set the LBA Detection Time parameter to two times the measured time.**

● **LBA Level**

- Set the control deviation when the control loop is working properly.
- The default is 8.0 (°C/°F) for Digital Controllers with Temperature Inputs and 10.00% FS for Digital Controllers with Analog Inputs.

● LBA Band

- There is assumed to be an error in the control loop and the alarm output turns ON if the control deviation is greater than the threshold set in the LBA Level parameter and if the control deviation does not change by at least the value set in the LBA Band parameter.
- The default is 3.0 (°C/°F) for Digital Controllers with Temperature Inputs and 0.20% FS for Digital Controllers with Analog Inputs.

The LBA is used.

The related parameters are as follows:





LBA Detection Time: 10

LBA Level: 8.0



LBA Band: 3.0

Operating Procedure



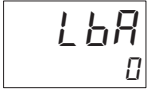

- Setting the LBA

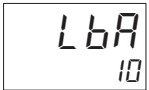
<p>1 Press the  Key several times in the Initial Setting Level to display <i>ALt 1</i> (Alarm 1 Type).</p>	<p>Initial Setting Level</p>  Alarm 1 Type
<p>2 Press the  or  Key to select <i>l2</i> (LBA). The default is <i>2</i> (upper limit).</p>	



- Setting the LBA Detection Time

<p>1 Press the  Key several times in the Advanced Function Setting Level to display <i>LbA</i> (LBA Detection Time).</p>	<p>Advanced Function Setting Level</p>  LBA Detection Time
<p>2 Press the  or  Key to set the value to 10. The default is 0 (s).</p>	

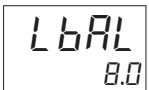
- Setting the LBA Level

<p>1 Press the  Key several times in the Advanced Function Setting Level to display <i>LbAL</i> (LBA Level).</p>	<p>Advanced Function Setting Level</p>  LBA Level
<p>2 Press the  or  Key to set the value to 8.0. The default is 8.0 (°C/°F).</p>	

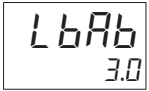
- Setting the LBA Band

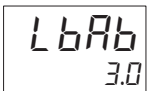
<p>1 Press the  Key several times in the Advanced Function Setting Level to display <i>LbAb</i> (LBA Band).</p>	<p>Advanced Function Setting Level</p>  LBA Band
<p>2 Press the  or  Key to set the value to 3.0. The default is 3.0 (°C/°F).</p>	

5-16 Performing Manual Control

Manual control can be used during PID control.

5-16-1 Manual MV

If you change to Manual Mode, the Manual MV parameter will be displayed and the displayed value will be output as the MV. If you change the setting of the Manual MV parameter, you can set any required MV. (The new value will be applied immediately.) The default setting of the Manual MV parameter is determined by the setting of the Manual Output Method parameter as shown below.

HOLD: The MV from immediately before moving to Manual Mode

INIT: The set value of the Manual MV Initial Value parameter

If the power supply is cycled during manual operation, operation will be restarted with the manual MV that was in effect before the power supply was interrupted. When the Manual MV Limit Enable parameter is set to ON (enable), the setting range will be from the MV lower limit to the MV upper limit. When operation is changed back to Automatic Mode, the MV from immediately before the change is inherited and then gradually changes to the value for Automatic Mode to prevent the MV from changing rapidly. (This is called balanceless-bumpless operation.)

The manual operation is illustrated in the following figure when the Manual Output Method parameter is set to HOLD.

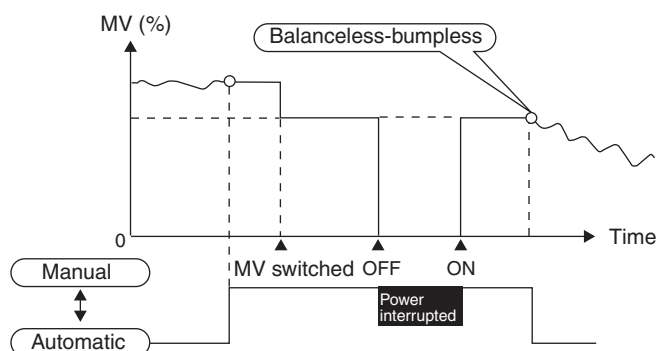

Precautions for Correct Use

- The automatic display return function will not operate in Manual Mode.
- Switching between automatic and manual operation is possible for a maximum of one million times.

● Related Displays and Parameters

Parameter name	Display	Setting range	Default	Level
Auto/Manual Switch ^{*1}	A-M	Switching between Automatic Mode and Manual Mode	---	Operation Level
PV/MV (Manual MV) ^{*2}	---	Standard control or position-proportional control: -5.0 to 105.0 Heating/cooling control: -105.0 to 105.0	---	Manual Control Level

Parameter name	Display	Setting range	Default	Level
Manual Output Method	<i>MANL</i>	HOLD INIT	HOLD	Advanced Function Setting Level
Manual MV Initial Value ^{*2}	<i>MANL</i>	Standard control: -5.0 to 105.0 Heating/cooling control: -105.0 to 105.0	0.0	
Manual MV Limit Enable MASK8	<i>MANL</i>	OFF: Disabled. ON: Enabled.	OFF	

*1 A mask is set to this parameter.

Refer to 5-12 *Hiding and Displaying Parameters*.

*2 If the Manual MV Limit Enable parameter is set to ON, this value will be between the MV upper limit and the MV lower limit.

Note: Refer to 5-18 *Output Adjustment Functions* for information on the order of priority for the MV.

● Moving to the Manual Control Level

• Moving with a Key Operation

- When the \square Key is pressed for at least 3 seconds in the Operation Level's auto/manual switching display*, the Manual Mode will be entered and the Manual Control Level will be displayed. It is not possible to move to any displays except for the PV/MV parameter during manual operation. Press the \square Key for at least one second from the PV/MV parameter display in Manual Control Level to return to Automatic Mode and display the top parameter in the Operation Level.

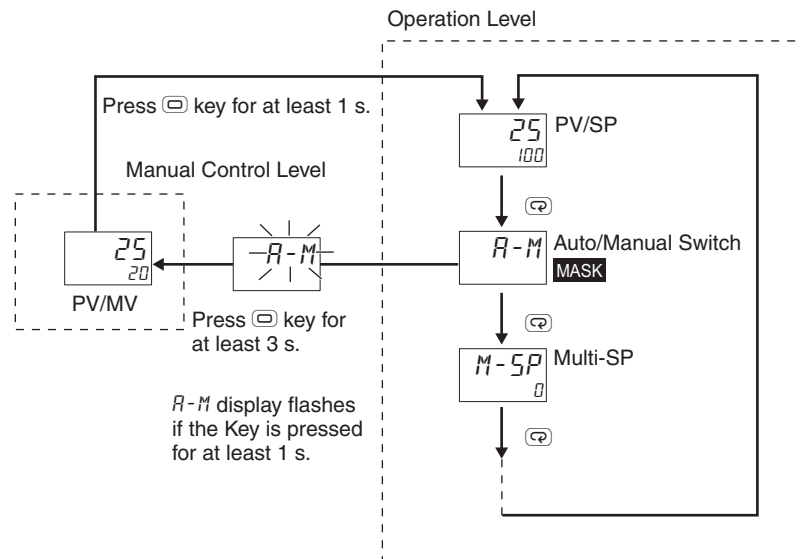

* The Auto/Manual Switch parameter is masked (not displayed) by default. To display it, refer to 5-12 *Hiding and Displaying Parameters*.

• Using the PF Key to Move to the Manual Control Level

- When the PF Setting parameter is set to A-M (Auto/Manual), pressing the PF Key for at least one second while in the Adjustment or Operation Level will change the mode to Manual Mode and move to the Manual Control Level. During manual operation it is not possible to move to any displays other than PV/MV (Manual MV). Press the \llcorner or \square Key for at least one second from the PV/MV display in the Manual Control Level to change the mode to Automatic Mode, move to the Operation Level, and display the top parameter in the Operation Level.

Note 1: Priority of Manual MV and Other Functions

Even when operation is stopped, the manual MV is given priority.

Auto-tuning will stop when Manual Mode is entered.

2: Manual MV and SP Ramp

If operating, the SP ramp function will continue even when Manual Mode is entered.



- Moving to the Manual Control Level with an Event Input

- If an event input is set to MANU (auto/manual), you can use the event input to switch between Automatic Mode and Manual Mode.



We will set the PF Setting parameter to A-M (auto/manual).

Operating Procedure



- Setting PID Control

<p>1 Press the  Key several times in the Initial Setting Level to display ENEL (PID ON/OFF).</p>	<p>Initial Setting Level</p> <div style="border: 1px solid black; padding: 5px; display: inline-block;"> <p>ENEL ON/OFF</p> </div> <p>PID ON/OFF</p>
<p>2 Press the  or  Key to set PID.</p>	<div style="border: 1px solid black; padding: 5px; display: inline-block;"> <p>ENEL PID</p> </div>

- Setting Auto/Manual Selection

<p>1 Press the  Key several times in the Advanced Function Setting Level to display PF (PF Setting).</p>	<p>Advanced Function Setting Level</p> <div style="border: 1px solid black; padding: 5px; display: inline-block;"> <p>PF SHFT</p> </div> <p>PF Setting</p>
<p>2 Press the  or  Key to select A-M (auto/manual).</p>	<div style="border: 1px solid black; padding: 5px; display: inline-block;"> <p>PF A-M</p> </div>

- Setting the Manual MV with the  Key

<p>1 Press the  Key in the Operation Level to enter the Manual Control Level.</p>	<p>Operation Level</p> <div style="border: 1px solid black; padding: 5px; display: inline-block;"> <p>25 0.0</p> </div> <p>PV/MV</p>
<p>2 Press the  or  Key to set the manual MV. (In this example, the MV is set to 50%.)*</p>	<div style="border: 1px solid black; padding: 5px; display: inline-block;"> <p>25 50.0</p> </div>

* The manual MV setting must be saved (see page *Applying Changes to Numeric Values* on page 3-7), but values changed with key operations are reflected in the control output immediately.

5-17 Using the Simple Program Function

5-17-1 Simple Program Function

- The simple program function can be used to execute program operation equivalent to two segments, like the operation shown below.

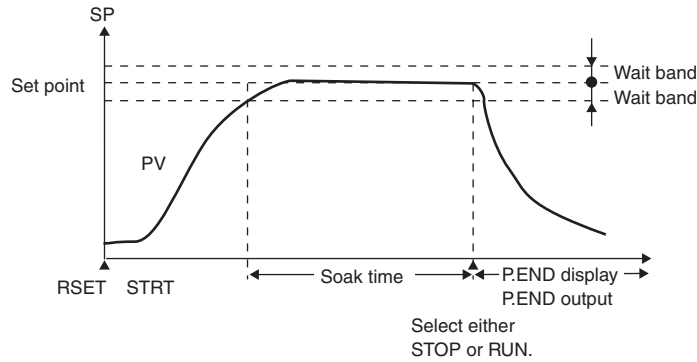

- The program will start when the Program Start parameter is changed from RSET to STRT. P.END will be displayed on the No. 2 display and, if one is assigned, the output assigned as the program end output will turn ON after the time set in the Soak Time parameter has expired in the wait band. The Program Pattern parameter can be used to select moving to STOP mode or continuing operation in RUN mode after the program ends.

● Parameters Related to the Simple Program Function

Parameter name	Display	Set (monitor) values	Unit	Display level
Program Pattern MASK8	<i>P L R N</i>	OFF, STOP, CONT	---	Initial Setting Level
Program Start	<i>P R S T</i>	RSET, STRT	---	Operation Level
Soak Time	<i>S O A K</i>	1 to 9999	min, h, or s	Adjustment Level
Soak Time Unit	<i>t - U</i>	s (seconds)/m (minutes)/h (hours)	---	Advanced Function Setting Level
Wait Band	<i>W E - b</i>	OFF or 0.1 to 999.9*	°C or °F*	Adjustment Level
Soak Time Remain Monitor	<i>S K E R</i>	0 to 9999	min, h, or s	Operation Level

- * The setting unit of the Wait Band parameter is %FS for Digital Controllers with Analog Inputs and the setting range is OFF or 0.01 to 99.99.

● Program Pattern

Either of two program patterns can be selected. The simple program operation will not be performed if the Program Pattern parameter is set to OFF.

(1) Pattern 1 (STOP)

Control will stop and the STOP mode will be entered when the program has ended.

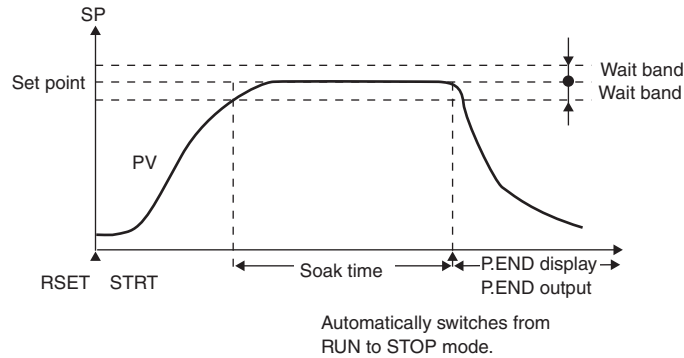

(2) Pattern 2 (CONT)

Control will continue in RUN mode when the program has ended.

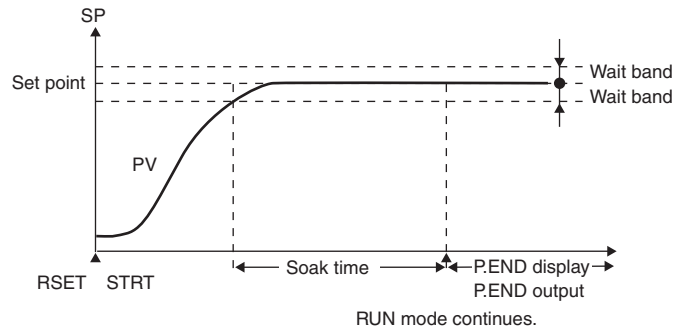

● Starting Method

Any of the following three methods can be used to start the simple program.

- Setting the Program Start parameter to STRT.
- Turning ON an event input. (The program start must be assigned to an event input.*)
- Starting with an Operation Command using communications. (When the program start is not assigned to an event input.)

* When the simple program is started and reset, writing is performed to non-volatile memory. Be sure to consider the write life (1 million writes) of the non-volatile memory in the system design. When the program start is assigned to an event input, the Program Start parameter will function as a monitor display, and the RSET/STRT displays can be used to check when the event input has started or reset the simple program. When this is done, the Program Start parameter functions as a monitor display only and cannot be changed using key operations. If the Program Pattern parameter is set to OFF, the event input assignment setting will be initialized to "None."

● Soak Time and Wait Band

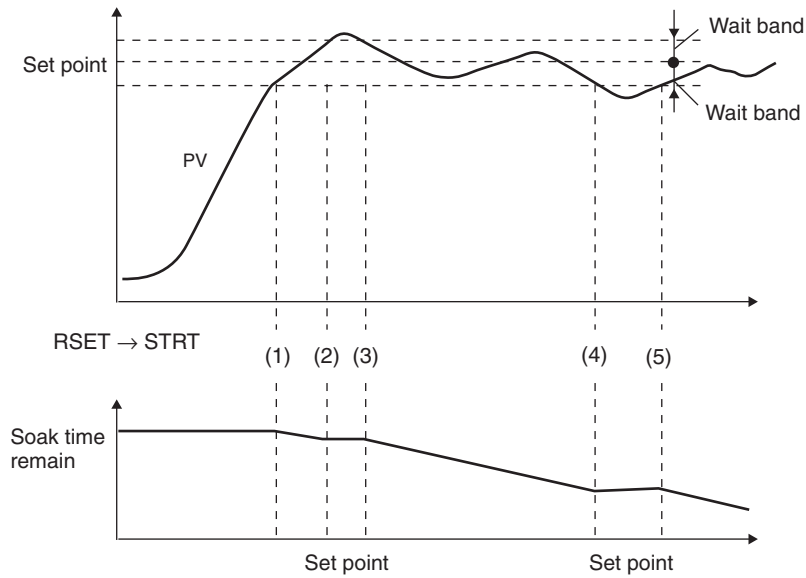

The wait band is the band within which the process value is stable in respect to the set point. The soak time is measured within the wait band. The timer that measures the soak time operates only when the process value is within the wait band around the set point (i.e., $SP \pm \text{wait band}$). In the above diagram, the timer will be stopped between the start and (1), (2) and (3), and (4) and (5) and will measure the time only between (1) and (2), (3) and (4), and (5) and the end.

* If the wait band is set to OFF, the wait band will be treated as infinity and the timer will measure time continuously after changing from RSET to STRT.

5-17-2 Operation at the Program End

- Display at the Program End

When the program ends, the process value will be displayed on the No. 1 display* and the set point and *P.END* will be alternately displayed on the No. 2 display at 0.5 s intervals.

* One of the following displays: PV/SP, PV only, or PV/MV.

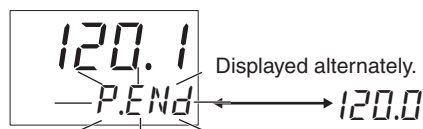

- Program End Output

The output assignment parameters can be used to assign the program END output to any output. The program END output can also be used in communications status.

When the Program Pattern parameter is changed from OFF to STOP or CONT, the Auxiliary Output 1 Assignment parameter will automatically be set to the P.END output. When the Program Pattern parameter is changed from STOP or CONT to OFF, the Alarm 1 Output Assignment parameter will automatically be initialized to ALM1 (or to HA for Digital Controllers that have HB or HS alarms).

- Clearing the Program End Status

The program END output and display will be cleared when the Program Start parameter is changed from STRT to RSET. The setting is changed from STRT to RSET while the Program Start parameter is displayed.

The program END status can also be cleared using an event. If the program start function is assigned to an event, however, the program end status cannot be cleared from the Program Start parameter display, which will function only as a monitor display.

Simple programming is used.

The related parameters are as follows:

Program pattern: STOP

Soak time = 10 min

Wait band: 3

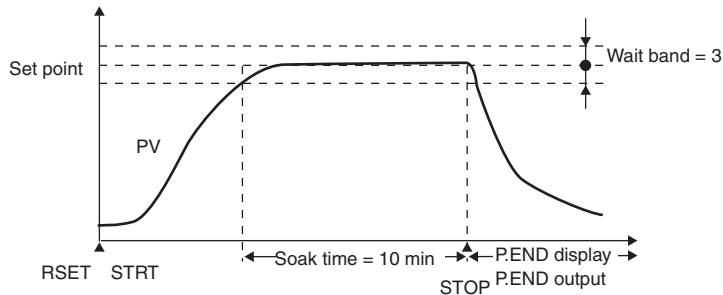

Operating Procedure

- Setting the Program Pattern

<p>1 Press the Key several times in the Initial Setting Level to display <i>PLRM</i> (Program Pattern).</p>	<p>Initial Setting Level</p> <div style="border: 1px solid black; padding: 5px; display: inline-block;"> <i>PLRM</i> <i>OFF</i> </div> <p>Program Pattern</p>
<p>2 Press the or Key to select <i>STOP</i> (STOP). The default is <i>OFF</i>.</p>	<div style="border: 1px solid black; padding: 5px; display: inline-block;"> <i>PLRM</i> <i>STOP</i> </div>

- Setting the Soak Time

<p>1 Press the Key several times in the Adjustment Level to display <i>SOAK</i> (Soak Time).</p>	<p>Adjustment Level</p> <div style="border: 1px solid black; padding: 5px; display: inline-block;"> <i>SOAK</i> <i>1</i> </div> <p>Soak Time</p>
<p>2 Press the or Key to set the value to 10. The default is 1 (min or h).</p>	<div style="border: 1px solid black; padding: 5px; display: inline-block;"> <i>SOAK</i> <i>10</i> </div>

- Setting the Wait Band

<p>1 Press the Key several times in the Adjustment Level to display <i>WE-b</i> (Wait Band).</p>	<p>Adjustment Level</p> <div style="border: 1px solid black; padding: 5px; display: inline-block;"> <i>WE-b</i> <i>OFF</i> </div> <p>Wait Band</p>
<p>2 Press the or Key to set the value to 3.0. The default is <i>OFF</i>.</p>	<div style="border: 1px solid black; padding: 5px; display: inline-block;"> <i>WE-b</i> <i>3.0</i> </div>

5-17-3 Application Example Using a Simple Program

The program will be started by changing the setting of the Program Start parameter. The following example shows using a simple program with the program pattern set to STOP.

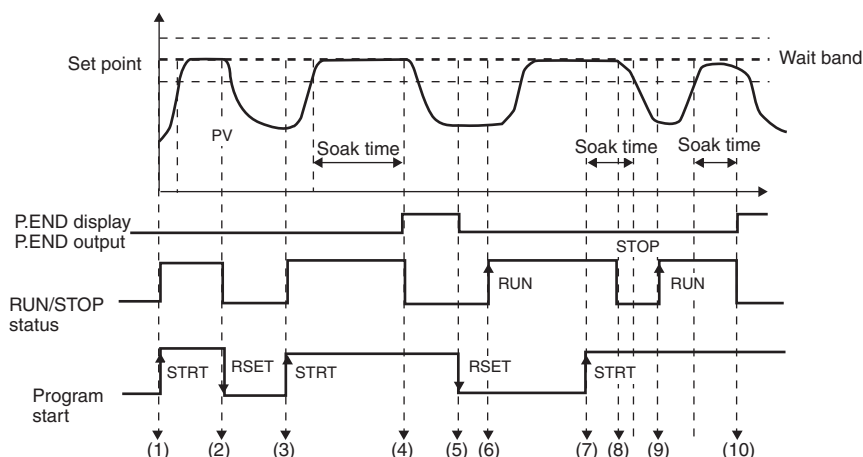

Timing	Description
(1)	<ul style="list-style-type: none"> The Program Start parameter was changed from RSET to STRT using either an event or key operations. The RUN/STOP status automatically changes to RUN mode when the above operation is performed.
(2)	<ul style="list-style-type: none"> The Program Start parameter was changed from STRT to RSET using either an event or key operations before the soak time expired. The RUN/STOP status automatically changes to STOP mode when the above operation is performed.
(3)	<ul style="list-style-type: none"> The Program Start parameter is again changed from RSET to STRT using either an event or key operations. The RUN/STOP status will automatically change to RUN mode when the above operation is performed.
(4)	<ul style="list-style-type: none"> The RUN/STOP status automatically changes to STOP mode when soak time expires. P.END flashes on the No. 2 display and the program END output turns ON.
(5)	<ul style="list-style-type: none"> The Program Start parameter is changed from STRT to RSET using either an event or key operations. The P.END display is cleared and the program END output turns OFF.
(6)	<ul style="list-style-type: none"> Key operations are used to switch the RUN/STOP status to RUN with the Program Start parameter set to RSET (stopped). Normal control operation is started.
(7)	<ul style="list-style-type: none"> The Program Start parameter is changed from RSET to STRT using either an event or key operations after the process value stabilizes. The RUN/STOP status remains as RUN.
(8)	<ul style="list-style-type: none"> Key operations are used to change the RUN/STOP status to STOP (during program operation). Measuring the soak time is continued within the wait band. (Measuring the soak time stops when the process value leaves the wait band.)
(9)	<ul style="list-style-type: none"> Key operations are used to change the RUN/STOP status to RUN. Measuring the soak time is continued within the wait band (continuing from the time between (7) and (9)).
(10)	<ul style="list-style-type: none"> The RUN/STOP status automatically changes to STOP mode when the measured time reaches the soak time. P.END flashes on the No. 2 display and the program END output turns ON.

5-18 Output Adjustment Functions

5-18-1 Output Limits

- Output limits can be set to control the output using the upper and lower limits to the calculated MV.
- The following MV takes priority over the MV limits.
Manual MV*
MV at stop
MV at PV error

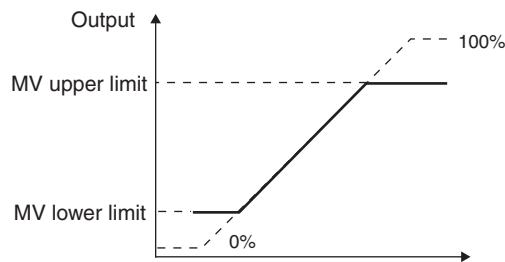

- * When the manual MV limit is enabled, the manual MV will be restricted by the MV limit.
- For heating/cooling control, upper and lower limits are set for overall heating/cooling control. (They cannot be set separately for heating/cooling.)

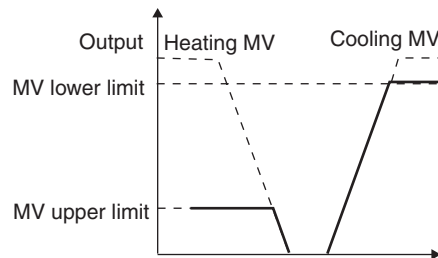

5-18-2 MV at Stop

The MV when control is stopped can be set.

For heating/cooling control, the MV at stop will apply to the cooling side if the MV is negative and to the heating side if the MV is positive. The default is 0.0, so an MV will not be output for either standard or heating/cooling control.

Parameter	Setting range	Unit	Default
MV at Stop	Standard control: -5.0 to 105.0	%	0.0
MASK	Heating/cooling control: -105.0 to 105.0		

Note: The order of priority in respect to the manual MV and the MV at PV error is as follows: Manual MV > MV at stop > MV at PV error.

5-18-3 MV at PV Error

A fixed MV is output when there is an input error. The MV at stop takes priority when control is stopped and the manual MV takes priority in Manual Mode.

For heating/cooling control, the MV at PV Error will apply to the cooling side if the MV is negative and to the heating side if the MV is positive. The default is 0.0, so an MV will not be output for either standard or heating/cooling control.

Parameter	Setting range	Unit	Default
MV at PV Error MASK	Standard control: -5.0 to 105.0 Heating/cooling control: -105.0 to 105.0	%	0.0

Note: The order of priority with respect to the manual MV and the MV at Stop is as follows: Manual MV > MV at stop > MV at PV error.

The order of priority of the MV is illustrated in the following diagram.

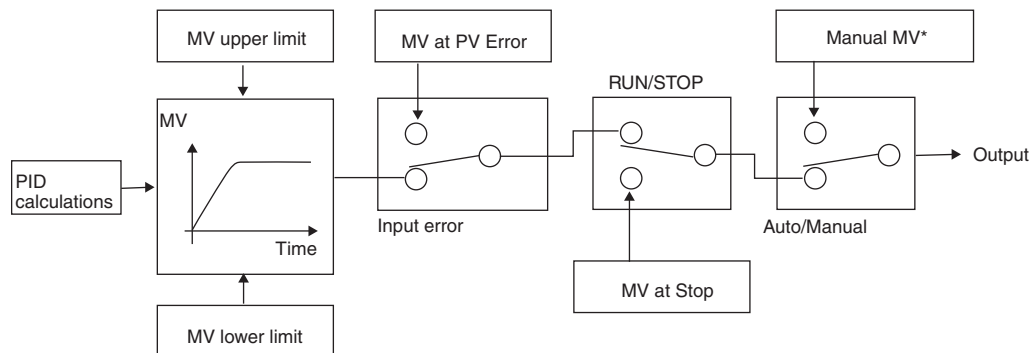

* When the Manual MV Limit Enable parameter is set to ON, the setting range will be the MV lower limit to the MV upper limit.

5-19 Using the Extraction of Square Root Parameter

5-19-1 Extraction of Square Roots

Extraction of Square Root Enable

SQR
OFF

Extraction of Square Root Low-cut Point

SQRP
0.0

- For analog inputs, the Extraction of Square Root parameter is provided for inputs so that differential pressure-type flow meter signals can be directly input.
- The default setting for the Extraction of Square Root parameter is OFF. The Extraction of Square Root Enable parameter must be set to ON in order to use this function.
- If the PV input (i.e., the input before extracting the square root) is higher than 0.0% and lower than the low cut point set in the Extraction of Square Root Low-Cut Point parameter, the results of extracting the square root will be 0.0%. If the PV input is lower than 0.0% or higher than 100.0%, extraction of the square root will not be executed, so the result will be equal to the PV input. The low-cut point is set as normalized data for each input, with 0.0 as the lower limit and 100.0 as the upper limit for the input setting range.

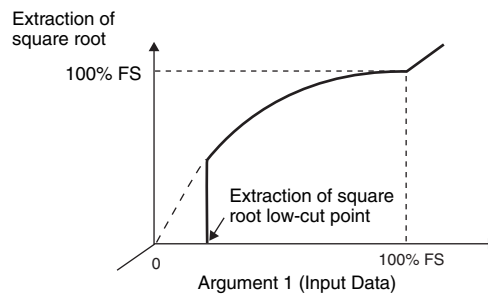

Parameter name	Setting range	Unit	Default	Level
Extraction of Square Root Enable MASK8	OFF: Disabled, ON: Enabled	---	OFF	Initial Setting Level
Extraction of Square Root Low-cut Point	0.0 to 100.0	%	0.0	Adjustment Level

This procedure sets the Extraction of Square Root Low-cut Point parameter to 10.0%.



The input type must be set for an analog input.

Operating Procedure

- Enabling Extraction of Square Roots

<p>1 Press the ⏏ Key several times in the Initial Setting Level to display SQR (Extraction of Square Root Enable).</p>	<p>Initial Setting Level</p> <p>SQR OFF</p> <p>MASK8</p> <p>Extraction of Square Root Enable</p>
<p>2 Press the ⏏ or ⏏ Key to select ON (Enabled). The default is OFF (disabled).</p>	<p>SQR ON</p> <p>MASK8</p>

- Setting the Extraction of Square Root Low-cut Point

<p>1 Press the  Key several times in the Adjustment Level to display <i>SQRP</i> (Extraction of Square Root Low-cut Point).</p>	<p>Adjustment Level</p> <div style="border: 1px solid black; padding: 5px; display: inline-block;"> <p><i>SQRP</i> 0.0</p> </div> <p>Extraction of Square Root Low-cut Point</p>
<p>2 Press the  or  Key to set the value to 10.0. The default is 0.0 (%).</p>	<div style="border: 1px solid black; padding: 5px; display: inline-block;"> <p><i>SQRP</i> 10.0</p> </div>

5-20 Setting the Width of MV Variation

5-20-1 MV Change Rate Limit

MV Change Rate
Limit

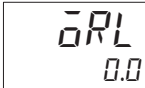

- The MV change rate limit sets the maximum allowable width of change per second in the MV. If the change in the MV exceeds this setting, the MV will be changed by the MV change rate limit until the calculated value is reached. This function is disabled when the setting is 0.0.
- The MV change rate limit does not function in the following situations:
 - In Manual Mode
 - During AT execution
 - During ON/OFF control
 - While stopped (during MV at Stop output)
 - During MV at PV Error output

Parameter name	Setting range	Unit	Default	Level
MV Change Rate Limit MASK8	0.0 to 100.0	%/s	0.0	Adjustment Level

This procedure sets the MV change rate limit to 5.0%/s. The related parameters are as follows:
PID ON/OFF = PID

Operating Procedure

- Setting 2-PID Control

<p>1 Press the Key several times in the Initial Setting Level to display <i>ENEL</i> (PID ON/OFF).</p>	<p>Initial Setting Level</p> <p>PID ON/OFF</p>
<p>2 Confirm that the control is set to <i>Pīd</i> (2-PID control). The default is <i>āNāF</i> (ON/OFF control).</p>	
<ul style="list-style-type: none"> • Setting the MV Change Rate Limit 	
<p>1 Press the Key several times in the Adjustment Level to display <i>āRL</i> (MV Change Rate Limit).</p>	<p>Adjustment Level</p> <p>MV Change Rate Limit</p> <p>MASK8</p>
<p>2 Press the or Key to set the value to 5.0. The default is 0.0 (%/s).</p>	<p>MASK8</p>

5-21 Setting the PF Key

5-21-1 PF Setting (Function Key)

PF Setting (Advanced Function Setting Level)

- Pressing the PF Key for at least one second executes the operation set in the PF Setting parameter. The default is *SHFT* (digit shift).



Set value	Display	Setting	Function
OFF	<i>OFF</i>	Disabled	Does not operate as a function key.
RUN	<i>RUN</i>	RUN	Specifies RUN status.
STOP	<i>StOP</i>	STOP	Specifies STOP status.
R-S	<i>R-S</i>	RUN/STOP reverse operation	Specifies reversing the RUN/STOP operation status.
AT-2	<i>At-2</i>	100% AT Execute/Cancel	Specifies reversing the 100% AT Execute/Cancel status.*1
AT-1	<i>At-1</i>	40% AT Execute/Cancel	Specifies reversing the 40% AT Execute/Cancel status.*1 *4
LAT	<i>LAt</i>	Alarm Latch Cancel	Specifies canceling all alarm latches.*2
A-M	<i>A-M</i>	Auto/Manual	Specifies reversing the Auto/Manual status.*3 *5
PFDP	<i>PFdP</i>	Monitor/Setting Item	Specifies the monitor/setting item display. Select the monitor setting item according to the Monitor/Setting Item 1 to 5 parameters (Advanced Function Setting Level).
SHFT	<i>SHFT</i>	Digit Shift	Operates as a Digit Shift Key when settings are being changed.
A-UD	<i>A-Ud</i>	PID Update (Adaptive Control)	The PID is updated when PID constants that can be updated are calculated for adaptive control.
FA	<i>fA</i>	Automatic Filter Adjustment	Specifies reversing between performing and stopping operation after automatic filter adjustment.
W-HT	<i>W-Ht</i>	Water-cooling Output Adjustment	Specifies reversing between performing and stopping water-cooling output adjustment.

*1 When AT cancel is specified, it means that AT is cancelled regardless of whether the AT currently being executed is 100% AT or 40% AT.

*2 Alarms 1 to 4, the HB alarm, and the HS alarm are cancelled.

*3 For details on auto/manual operations using the PF Key, refer to *5-16 Performing Manual Control*.

*4 AT-1 can be set for heating/cooling control or for floating position-proportional control, but the setting will be disabled.

*5 The function that is set for the PF Key is disabled if the same function is assigned to an event input. For the default event input assignments, refer to *Event Input Assignment 1 to Event Input Assignment 6* on page 6-57.

Note1: Pressing the PF Key for at least one second executes operation according to the set value. (However, if Digit Shift is set, operation will be in less than one second.) When the Monitor/Setting Item parameter is selected, however, the display is changed in order from Monitor/Setting Item 1 to 5 each time the key is pressed.

2: This function is enabled when PF Key Protect is OFF.

● Monitor/Setting Item MASK8

Monitor/Setting Item 1
(Advanced Function Setting
Level)

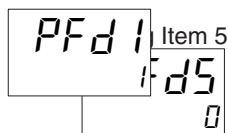

Setting the PF Setting parameter to the Monitor/Setting Item makes it possible to display monitor/setting items using the PF Key. The following table shows the details of the settings. For setting (monitor) ranges, refer to the applicable parameter.

Set value	Setting ^{*2}	Remarks	
		Monitor/Setting	Display
0	Disabled		---
1	PV/SP/Multi-SP	Can be set. (SP) ^{*1}	---
2	PV/SP/MV (Heating)	Can be set. (SP) ^{*1}	---
3	PV/SP /Soak time remain	Can be set. (SP) ^{*1}	---
4	Proportional band (P)	Can be set.	P
5	Integral time (I)	Can be set.	I
6	Derivative time (D)	Can be set.	d
7	Alarm value 1	Can be set.	AL - 1
8	Alarm value upper limit 1	Can be set.	AL 1H
9	Alarm value lower limit 1	Can be set.	AL 1L
10	Alarm value 2	Can be set.	AL - 2
11	Alarm value upper limit 2	Can be set.	AL 2H
12	Alarm value lower limit 2	Can be set.	AL 2L
13	Alarm value 3	Can be set.	AL - 3
14	Alarm value upper limit 3	Can be set.	AL 3H
15	Alarm value lower limit 3	Can be set.	AL 3L
16	Alarm value 4	Can be set.	AL - 4
17	Alarm value upper limit 4	Can be set.	AL 4H
18	Alarm value lower limit 4	Can be set.	AL 4L
19	PV/SP/Internal SP	Can be set. (SP) ^{*1}	---
20	PV/SP/Alarm Value 1	Can be set. (SP) ^{*1}	---
21	Proportional Band (Cooling)	Can be set.	I - P
22	Integral Time (Cooling)	Can be set.	I - I
23	Derivative Time (Cooling)	Can be set.	I - d
24	PV/SP/MV (Cooling)	Can be set. (SP) ^{*1}	---

*1 With the E5CD or E5CD-B, only the PV and SP can be displayed.

*2 If the display condition is not met for even one of the set parameters, the monitor/setting item display will not appear.

Setting Monitor/Setting Items



Pressing the **PF** Key in either the Operation or Adjustment Level displays the applicable monitor/setting items. Press the **PF** Key to display in order Monitor/Setting Items 1 to 5. After Monitor/Setting Item 5 has been displayed, the display will switch to the top parameter in the Operation Level.

- Note 1: Items set as disabled in the Monitor/Setting Items 1 to 5 parameters will not be displayed, and the display will skip to the next enabled setting.
- 2: While a monitor/setting item is being displayed, the display will be switched to the top parameter in the Operation Level if the **PF** Key or the **PF** Key is pressed.

This procedure sets the PF Setting parameter to PFDP, and the Monitor/Setting Item 1 parameter to 7 (Alarm Value 1).

Operating Procedure

- Setting the PF Key

<p>1 Press the PF Key several times in the Advanced Function Setting Level to display PF (PF Setting).</p>	<p>Advanced Function Setting Level</p>  <p>PF Setting</p>
<p>2 Press the ▲ or ▼ Key to select PFdP (Monitor/Setting Item). The default is SHFt (digit shift).</p>	

- Setting the Monitor/Setting Items

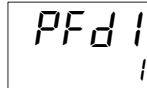
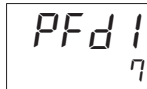
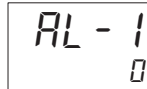
<p>1 Press the PF Key several times in the Advanced Function Setting Level to display PFd 1 (Monitor/Setting Item 1).</p>	<p>Advanced Function Setting Level</p>  <p>Monitor/Setting Item 1</p> <p>MASK8</p>
<p>2 Press the ▲ or ▼ Key to select 7 (Alarm Value 1). The default is 1 (PV/SP/Multi-SP No.).</p>	 <p>MASK8</p>
<p>3 Return to the Operation Level and press the PF Key to display AL - 1 (Alarm Value 1).</p>	<p>Monitor/Setting Item Level</p>  <p>Monitor/Setting Item Display 1</p>

5-22 Displaying PV/SV Status

5-22-1 PV and SV Status Display Functions

● PV Status Display Function (Advanced Function Setting Level)

The PV on the No. 1 display in the PV, PV/SP, PV/Manual MV, or PV/SP Manual MV Display and the control or alarm status specified for the PV status display function are alternately displayed in 0.5-s cycles.*¹

- PV
- PV/SP*²
- PV/Manual MV
- PV/SP/Manual MV

*¹ This includes the displays specified with the PV/SP No. 1 and PV/SP No. 2 Display Selection parameters.

*² This includes when the PV/SP is selected for the Monitor/Setting Item parameter.

Set value	Display	Function
OFF	<i>OFF</i>	No PV status display
Manual	<i>MANU</i>	MANU is alternately displayed during manual control.
Stop	<i>StOP</i>	STOP is alternately displayed while operation is stopped.
Alarm 1	<i>ALM1</i>	ALM1 is alternately displayed during Alarm 1 status.
Alarm 2	<i>ALM2</i>	ALM2 is alternately displayed during Alarm 2 status.
Alarm 3	<i>ALM3</i>	ALM3 is alternately displayed during Alarm 3 status.
Alarm 4	<i>ALM4</i>	ALM4 is alternately displayed during Alarm 4 status.
Alarm 1 to 4 OR status	<i>ALM</i>	ALM is alternately displayed when Alarm 1, 2, 3, or 4 is set to ON.
Heater Alarm	<i>HA</i>	HA is alternately displayed when an HB alarm or HS alarm is ON.

Note: The default is OFF.

Example: When STOP Is Selected for the PV Status Display Function

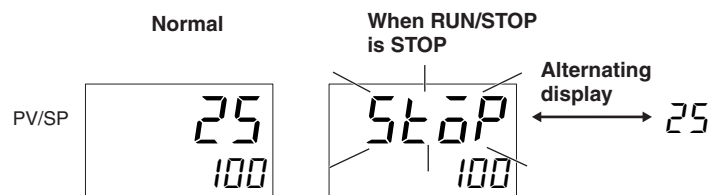

● SV Status Display Function (Advanced Function Setting Level)

The SP, Manual MV, or blank on the No. 2 display in the PV/SP, PV, or PV/Manual MV Display and the control or alarm status specified for the SV status display function are alternately displayed in 0.5-s cycles.*¹

- PV
- PV/SP*²
- PV/Manual MV
- PV/SP/Manual MV

*¹ This includes the displays specified with the PV/SP No. 1 and PV/SP No. 2 Display Selection parameters.

*² This includes when the PV/SP is selected for the Monitor/Setting Item parameter.

Set value	Display	Function
OFF	<i>OFF</i>	No SV status display
Manual	<i>MANU</i>	MANU is alternately displayed during manual control.
Stop	<i>StOP</i>	STOP is alternately displayed while operation is stopped.
Alarm 1	<i>ALM1</i>	ALM1 is alternately displayed during Alarm 1 status.

Set value	Display	Function
Alarm 2	ALM2	ALM2 is alternately displayed during Alarm 2 status.
Alarm 3	ALM3	ALM3 is alternately displayed during Alarm 3 status.
Alarm 4	ALM4	ALM4 is alternately displayed during Alarm 4 status.
Alarm 1 to 4 OR status	ALM	ALM is alternately displayed when Alarm 1, 2, 3, or 4 is set to ON.
Heater Alarm	HA	HA is alternately displayed when an HB alarm or HS alarm is ON.

Note: The default is OFF.

Example: When ALM1 Is Selected for the SV Status Display Function

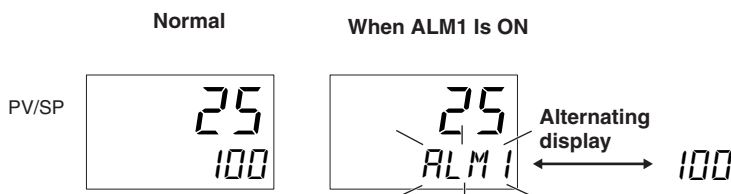

Additional Information

Priority of Flashing and Alternating Displays on No. 2 Display

The priority for flashing and alternating displays is as follows:

- (1) Alternating display with SV status display
- (2) Alternating display during program end output

The following procedure sets the PV Status Display Function parameter to ALM1.

Operating Procedure

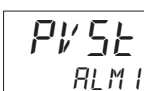
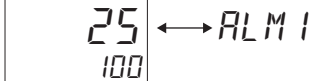
<p>1 Press the Key several times in the Advanced Function Setting Level to display <i>PV St</i> (PV Status Display Function).</p>	<p>Advanced Function Setting Level</p>  <p>PV Status Display Function</p>
<p>2 Press the or Key to select <i>ALM 1</i> (alarm 1). The default is <i>OFF</i>.</p>	
<p>3 If the Alarm 1 status is ON in Operation Level, the PV and <i>ALM 1</i> (Alarm 1) will be alternately displayed.</p>	<p>Operation Level</p> 

5-23 Logic Operations 000

5-23-1 The Logic Operation Function (CX-Thermo)

- The logic operation function logically calculates as 1 or 0 the Digital Controller status (alarms, SP ramp, RUN/STOP, auto/manual, etc.) and the external event input status, and outputs the results to work bits. The work bit status can be output to auxiliary or control outputs, and operating status can be switched according to the work bit status.
- Work bit logic operation can be set from 1 to 8. Set them to *No operation (Always OFF)* (the default) when the work bits are not to be used.
- When logic operations are being used, a dot will be displayed between the first two digits on the No. 2 display of the Adjustment Level display

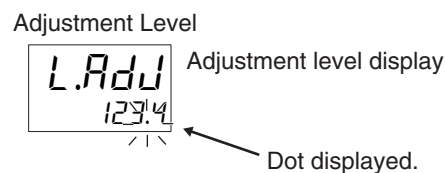

Note: The four numeric digits to identify the product code are displayed in the No. 2 display.

5-23-2 Using Logic Operations

Logic operations are set using the CX-Thermo.

● Starting Logic Operations

There are two ways to start logic operations.

- Select *Logic Operation Editor* from the CX-Thermo tree, and click the **Start** Button.

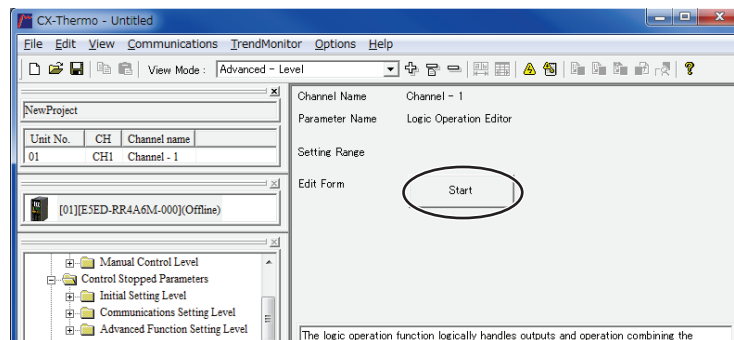

- Select *Logic Operation Editor* from the CX-Thermo Options Menu.

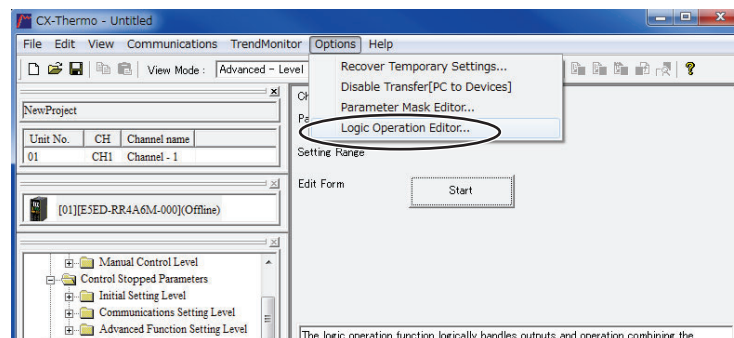

● **Making the Settings**

The following display will appear on the Logic Operation Editor Setting Window. Set each of the parameters.

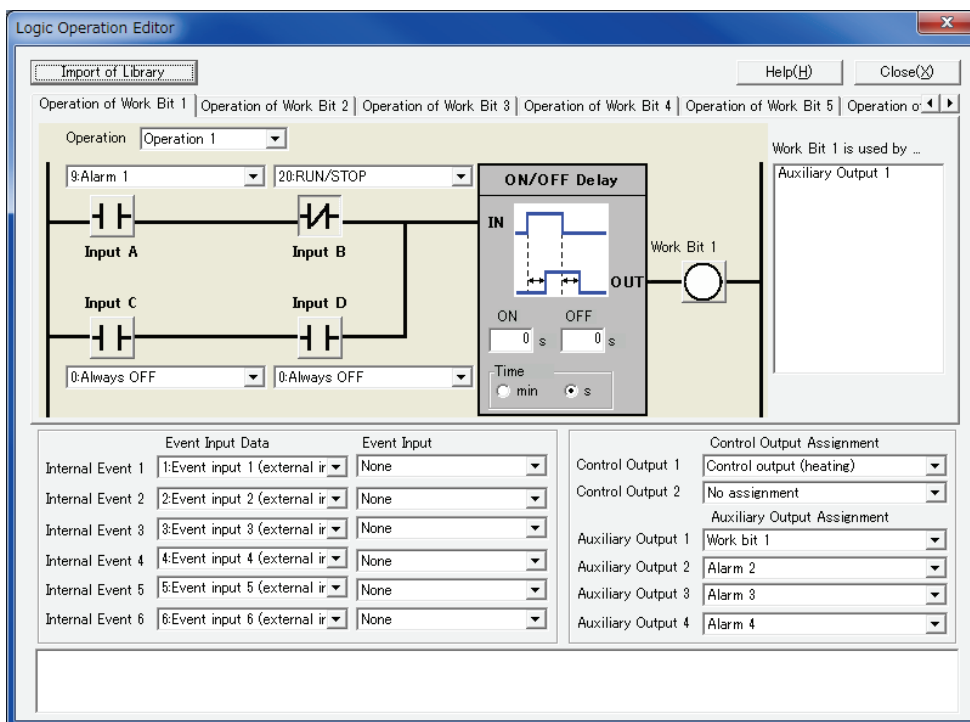

(1) Displaying the Library Import Dialog Box

Logic operation samples for specific cases are set in the library in advance. Examples of settings for specific cases are loaded by selecting them from the library list and clicking the **OK** Button.

Example: Selecting Library 1

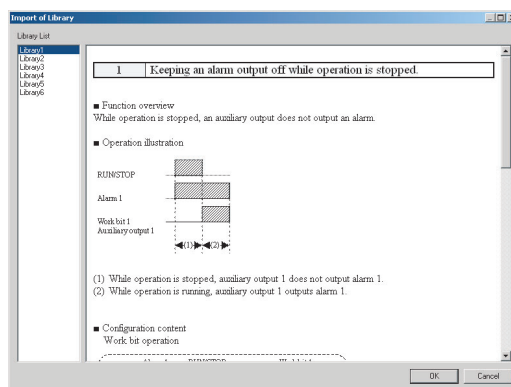

(2) Switching Work Bit Operations

Select the work bit logic operations from the Operation of Work Bit 1 to Operation of Work Bit 8 Tab Pages.

(3) Selecting the Operation Type

From one to four operations are supported. If work bits are not to be used, set them to *No operation (Always OFF)* (the default).

- No operation (Always OFF)

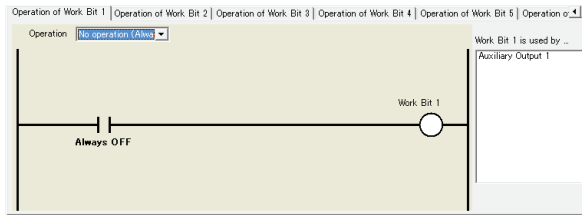

- Operation 1

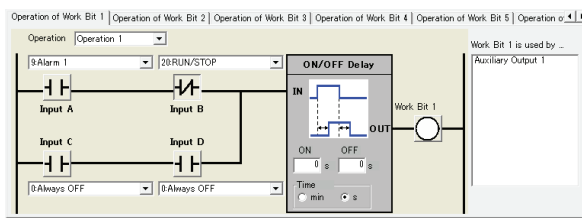

(A and B) or (C and D)
When conditions A and B or conditions C and D are satisfied

- Operation 2

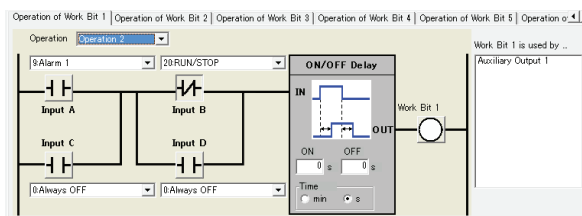

(A or C) and (B or D)
When condition A or C and condition B or D are satisfied

- Operation 3

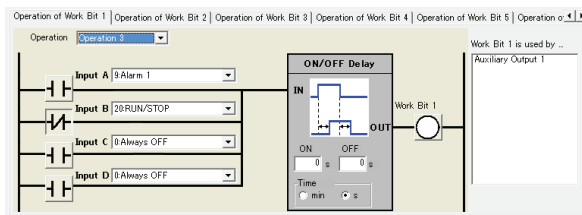

A or B or C or D
When condition A, B, C or D is satisfied

- Operation 4

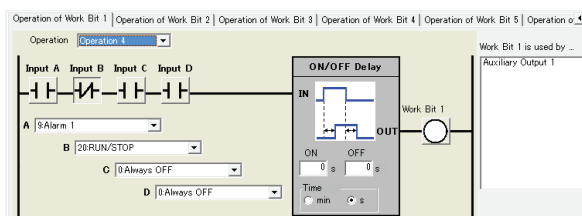

A and B and C and D
When conditions A, B, C and D are all satisfied

(4) Selecting Input Assignments



Select the input assignment for the work bit logic operation from the following settings.

Parameter name	Setting range
Work Bit 1 Input Assignment A	0. Always OFF
	1. Always ON
	2. ON for one cycle when power is turned ON
	3. Event input 1 (external input)*
	4. Event input 2 (external input)*
	5. Event input 3 (external input)*
	6. Event input 4 (external input)*
	7. Event input 5 (external input)*
	8. Event input 6 (external input)*
	9. Alarm 1
	10. Alarm 2
	11. Alarm 3
	12. Alarm 4
	13. Control output (heating)
	14. Control output (cooling)
	15. Input error
	16. Always OFF
	17. HB (heater burnout) alarm
	18. HS alarm
	19. Auto/Manual
	20. RUN/STOP
	21. Always OFF
	22. Program start
	23. AT Execute/Cancel
	24. SP ramp operating
	25. Multi-SP No. switching bit 0
	26. Multi-SP No. switching bit 1
	27. Multi-SP No. switching bit 2
	28. Program end output
	29. Work bit 1
	30. Work bit 2
	31. Work bit 3
	32. Work bit 4
	33. Work bit 5
	34. Work bit 6
	35. Work bit 7
	36. Work bit 8
	37. Adaptive control in progress (system performance evaluation)
	38. Adaptive control notification in progress
	39. Automatic filter adjustment in progress
40. Adaptive control PID update enabled	
Work Bit 1 Input Assignment B	Same as for work bit 1 input assignment A
Work Bit 1 Input Assignment C	Same as for work bit 1 input assignment A
Work Bit 1 Input Assignment D	Same as for work bit 1 input assignment A
to	to
Work Bit 8 Input Assignment D	Same as for work bit 1 input assignment A

* The event inputs that can be used depend on the Digital Controller model.



(5) Switching between Normally Open and Normally Closed for Inputs A to D

Click the condition to switch between normally open and normally closed inputs A to D.

Normally open	Normally closed
	

(6) Switching between Normally Open and Normally Closed for Work Bits

Click the condition to switch between normally open and normally closed work bits.

Normally open	Normally closed
	

(7) Setting ON Delay Times

When an input with ON delay turns ON, the output will turn ON after the set delay time has elapsed. The setting range is 0 to 9,999. The default is 0 (disabled).

(8) Setting OFF Delay Times

When an input with OFF delay turns OFF, the output will turn OFF after the set delay time has elapsed. The setting range is 0 to 9,999. The default is 0 (disabled).

(9) Switching ON/OFF Delay Time Unit

Select either seconds or minutes for the ON/OFF delay time unit. The default is seconds. If the Work Bit * Operation Type is set to anything but OFF, the Work Bit * ON Delay and Work Bit * OFF Delay will be displayed in the Adjustment Level and the settings can be changed with key operations.

(10) Changing Event Input Data

Select the event input conditions from the following setting ranges.

Parameter name	Setting range
Internal event 1	0. Not assigned.
	1. Event input 1 (external input)
	2. Event input 2 (external input)
	3. Event input 3 (external input)
	4. Event input 4 (external input)
	5. Event input 5 (external input)
	6. Event input 6 (external input)
	7. Work bit 1
	8. Work bit 2
	9. Work bit 3
	10. Work bit 4
	11. Work bit 5
	12. Work bit 6
	13. Work bit 7
14. Work bit 8	
Internal event 2	Same as for Event Input Data 1.
Internal event 3	Same as for Event Input Data 1.
Internal event 4	Same as for Event Input Data 1.
Internal event 5	Same as for Event Input Data 1.
Internal event 6	Same as for Event Input Data 1.

Note: The internal event data can be changed from the default setting even if there is no event input terminal (external input). By changing the default setting, the event input assignment parameters will be displayed at the Digital Controller display and can be set from the Digital Controller.

(11) Changing the Event Input Assignment Function

Select the setting for the internal event assignment.

When a work bit is selected as event input data, Communications Write Enable/Disable cannot be assigned to an event input.

(12) Changing Control Output and Auxiliary Output Settings

Control output and auxiliary output assignments can be changed. The items that can be changed depend on the Digital Controller model. For details, refer to *4-6 Setting Output Specifications*.

Assigning a work bit to either a control output or to an auxiliary output is also considered to be the same as assigning an alarm. For example, if work bit 1 is set for the Auxiliary Output 1 Assignment parameter, then alarms 1 to 4 have been assigned.

(13) Displaying Parameter Guides

A description of the parameters can be displayed.

(14) Displaying the Work Bit Use Destinations

Display a list of destinations where the work bits are used.

Operating Procedure

This procedure uses event input 2 to change to RUN or STOP.

Event input 2 ON: RUN

Event input 2 OFF: STOP

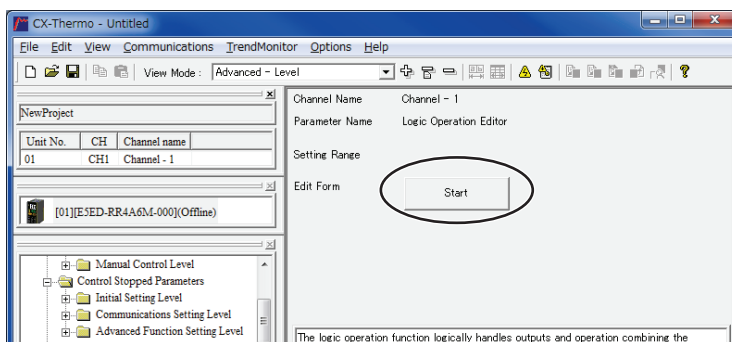
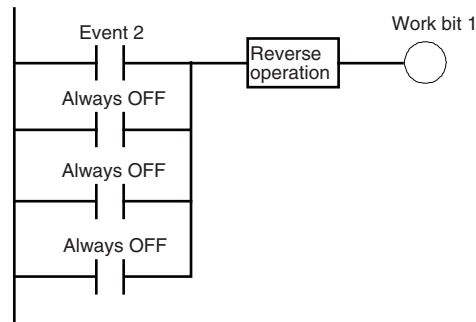

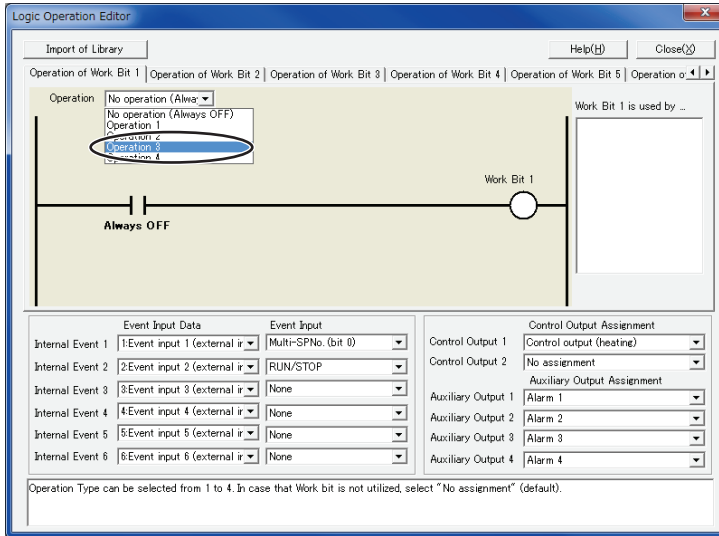

1. Select *Logic Operation Editor* from the CX-Thermo tree, and click the **Start** Button.

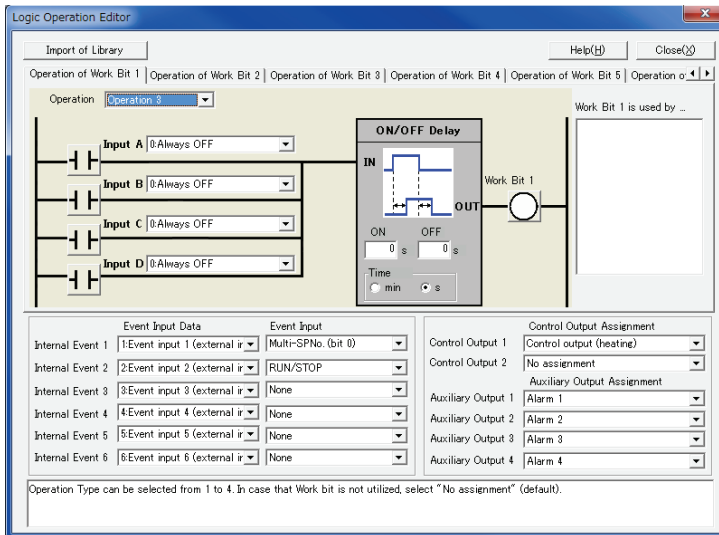

2. The Logic Operation Editor will be displayed. Confirm that the screen for work bit 1 is displayed, and select *Operation 3* from the *Operation Type* Field.



3. Set the operation by selecting one of the following:
 Work bit 1 input assignment A = 4: Event input 2 (external input)
 Work bit 1 input assignment B = 0: Always OFF
 Work bit 1 input assignment C = 0: Always OFF
 Work bit 1 input assignment D = 0: Always OFF

4. Invert work bit 1. Click  (Normally open) to change it to  (Normally closed).

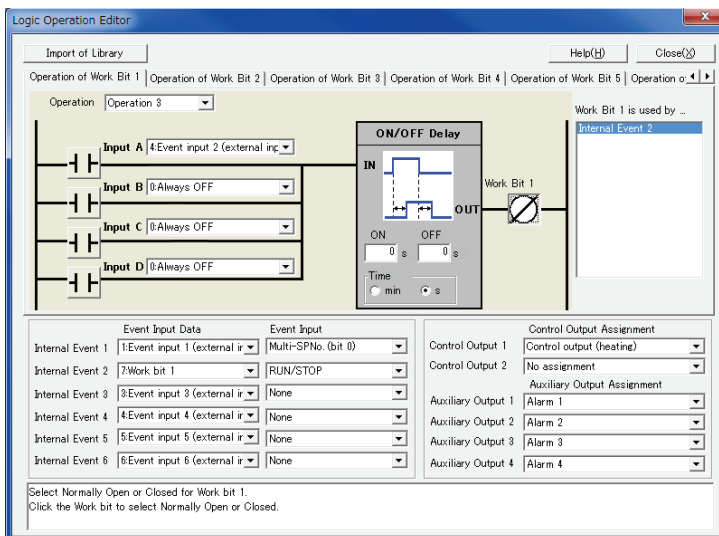

5. Assign RUN/STOP to event input 2. Set "7: Work bit 1" for the event input data for event input 2, and set "RUN/STOP" for the assignment function.

6. Closing the Logic Operation Editor Dialog Box Click the **Close** Button. This completes the procedure for setting parameters using the CX-Thermo. Transfer the settings to the Digital Controller to set the Digital Controller. Refer to CX-Thermo help for the procedure to transfer the settings.

Operating Procedure

This procedure outputs alarm 1 status to auxiliary output 1 during operation (RUN). A library object is used to make the setting.

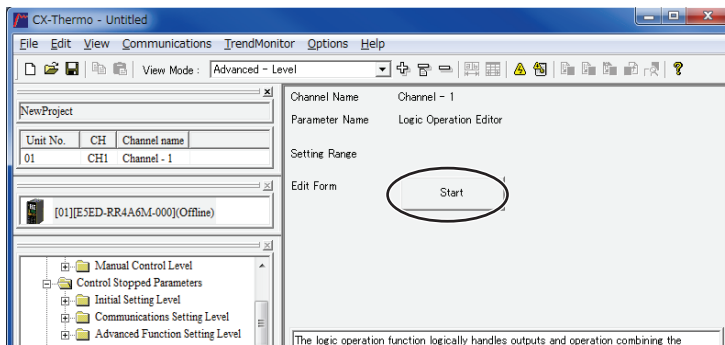
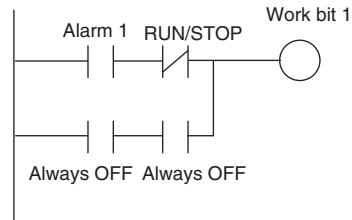

1. Select **Logic Operation Editor** from the CX-Thermo tree, and click the **Start** Button.

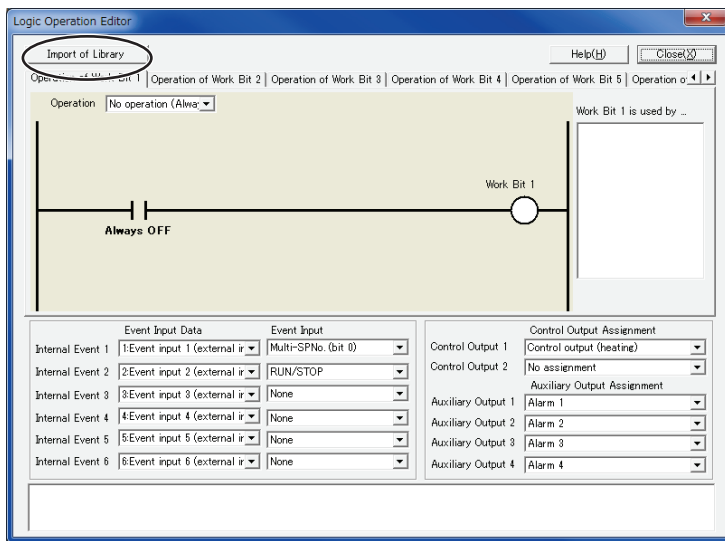

2. Click the **Import of Library** Button.

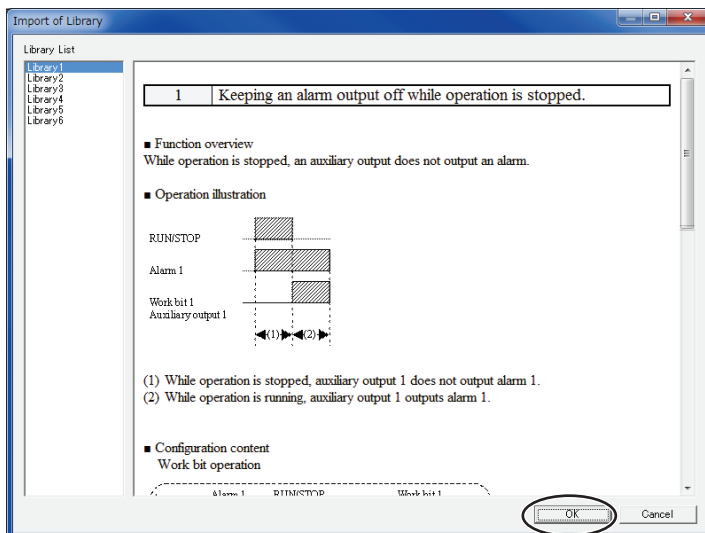

3. Select **Library 1** from the library list, and then click the **OK** Button.

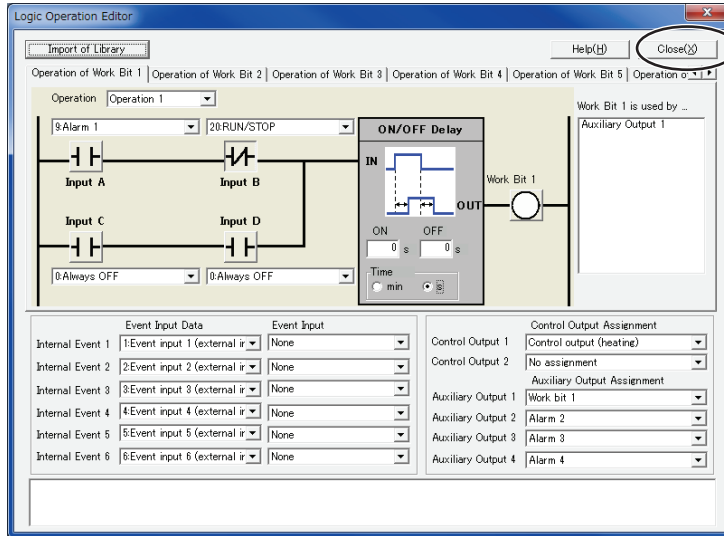

4. Confirm the following settings, and then click the **OK** Button.
- Work bit 1 operation type:
 Operation 1
 Work bit 1 input assignment
 A = 9: Alarm 1
 Work bit 1 input assignment
 B = 20: Invert for
 RUN/STOP
 Work bit 1 input assignment
 C = 0: Always OFF
 Work bit 1 input assignment
 D = 0: Always OFF
 Auxiliary output 1 = Work bit
 1
- Closing the Logic Operation Editor Dialog Box
 Click the **Close** Button.
- This completes the procedure for setting parameters using the CX-Thermo. Transfer the settings to the Digital Controller to set the Digital Controller. Refer to CX-Thermo help for the procedure to transfer the settings.

5-24 Initializing Settings









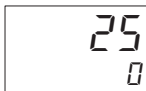

You can set the Parameter Initialization parameter (Advanced Function Setting Level) to *FACT* (initialize parameters to defaults given in the manual) to return all of the parameter settings to the factory defaults.

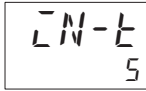
The default is OFF.





Operating Procedure

● Moving to the Advanced Function Setting Level

- * Refer to 4-1-4 *Moving to the Advanced Function Setting Level* for the procedure to enter the Advanced Function Setting Level if you have not done so before.

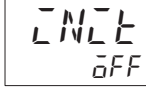
<p>1 Press the  Key for at least 3 seconds in the Operation Level. The No. 1 display will flash when the key is pressed for 1 s or longer. The display will change from the Operation Level to the Initial Setting Level.</p>	<p>Operation Level</p> 
<p>2 Press the  Key several times in the Initial Setting Level to display the Move to Advanced Function Setting Level parameter. <i>AMOV</i> (Move to Advanced Function Setting Level) will be displayed.</p>	<p>Initial Setting Level</p>  Input Type
<p>3 Press the  and  Keys at the Move to Advanced Function Setting Level parameter and then enter - 169.</p> <p>* You can hold the  or  Key to increment or decrement the set value quickly.</p>	<p>Initial Setting Level</p>  Move to Advanced Function Setting Level
<p>4 Press  Key once or wait for 2 seconds or longer without doing anything. You will move to the Advanced Function Setting Level and <i>LNLE</i> (Parameter Initialization) will be displayed.</p>	<p>Initial Setting Level</p>  Move to Advanced Function Setting Level -169: Password to move to Advanced Function Setting Level

● Parameter Initialization

<p>1 Display the first parameter, <i>LNLE</i> (Parameter Initialization) in the Advanced Function Setting Level.</p>	<p>Advanced Function Setting Level</p>  Parameter Initialization
<p>2 Press the  or  Key to select <i>FACT</i> (initialize to the factory settings described in the manual). The parameter settings will be initialized. The default is <i>OFF</i>.</p>	<p>Advanced Function Setting Level</p> 

- * The parameter mask settings are not initialized when other settings are initialized. Refer to *Parameter Mask Enable* on page 6-5.

5-25 Setting the Operating Status to Use When Power Is Turned ON

You can set the operating status to use when the power supply is turned ON (including software resets).

You can set this with the $P-\bar{O}N$ (Operation After Power ON) parameter in the Initial Setting Level. The default setting is to continue (the same status as when power was interrupted).

You can set any of the following options.

Operating status	Description
Continue (default)	The status when power was interrupted is continued. <ul style="list-style-type: none"> If operation (run) was in progress when power was interrupted, operation will start. If control was stopped (stop) when power was interrupted, control will be stopped. If Manual Mode was in progress when power was interrupted, Manual Mode will be entered.
Stop	Control will be stopped (stop).
Manual	Manual Mode will be entered.

● Parameters

Parameter	Display	Setting range	Default	Level
Operation After Power ON	$P-\bar{O}N$	$\bar{C}O N T$: Continue (status at power OFF) $S T O P$: Control stopped (stop) $M A N U$: Manual Mode	$\bar{C}O N T$	Initial Setting Level

Note: Priority of Event Inputs

- If an event input is assigned to RUN/STOP, the setting of the Operation After Power ON parameter (STOP) will be given priority.
- If an event input is assigned to Auto/Manual, the Auto/Manual specification of the event input will be given priority over the setting of the Operation After Power ON parameter (Manual).

Operating Procedure

The following example shows how to set the Digital Controller to stop control when the power supply is turned ON.

- Setting the Operation After Power ON Parameter

<p>1 Press the Ⓢ Key several times in the Initial Setting Level to display $P-\bar{O}N$ (Operation After Power ON). The default is $\bar{C}O N T$ (continue).</p>	<p>Initial Setting Level</p> <div style="border: 1px solid black; padding: 5px; display: inline-block;"> $P-\bar{O}N$ $\bar{C}O N T$ </div> <p>Operation After Power ON</p>
<p>2 Press the ⏏ or ⏏ Key to set the parameter to $S T O P$ (stop).</p>	<div style="border: 1px solid black; padding: 5px; display: inline-block;"> $P-\bar{O}N$ $S T O P$ </div>

5-26 Using the Transfer Output for the Process Value, Set Point, or other Data 000

5-26-1 Transfer Output Function

A transfer output can be used on models that have a transfer output.

● Precision and User Calibration

Precision	User calibration
±0.3% FS	Supported.*

* For details on calibration, refer to *Section 7 User Calibration*.

● Transfer Output Signal (Initial Setting Level)

You can use the Transfer Output Signal parameter to specify whether to output a current or voltage from the transfer output.

Terminal Arrangement

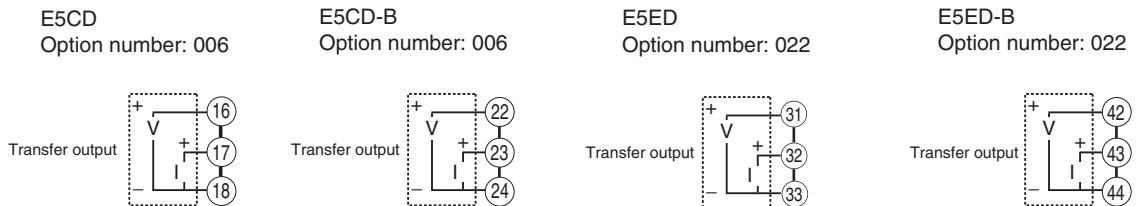

Setting range	Default
4-20: 4 to 20mA	4-20
1-5V: 1-5 V	

● Transfer Output Type (Initial Setting Level)

You can use the Transfer Output Type parameter to specify any of six types of data to output.

Transfer output type	Display	Setting range
OFF (default)	OFF	---
Set point	SP	SP lower limit to SP upper limit
Set point during SP ramp	SP-M	SP lower limit to SP upper limit
PV	PV	Input setting range lower limit to input setting range upper limit or Scaling lower limit to scaling upper limit
MV monitor (heating)*	MV	-5.0 to 105.0 (heating/cooling control: 0.0 to 105.0)
MV monitor (cooling)	C-MV	0.0 to 105.0
Valve opening	V-M	-10.0 to 110.0

* This function can be set for a Standard Control Model, but the setting will be disabled.

● Transfer Scaling

- Reverse scaling is possible by setting the Transfer Output Lower Limit parameter larger than the Transfer Output Upper Limit parameter. If the Transfer Output Lower Limit and Transfer Output Upper Limit parameters are set to the same value, the transfer output will be output continuously at 0%.
- If the SP, SP during SP ramp, or PV is selected, the Transfer Output Upper Limit and Transfer Output Lower Limit parameters will be forcibly initialized to the respective upper and lower setting limits if any of the following parameters is changed: Input Type, Scaling Upper Limit, Scaling Lower Limit, Set Point Upper Limit, Set Point Lower Limit, or Temperature Unit.
If the MV for heating or MV for cooling is selected, the Transfer Output Lower Limit and Transfer Output Upper Limit parameters will be initialized to 100.0 and 0.0, respectively, when a switch is made between standard control and heating/cooling control using the Standard or Heating/Cooling parameter.
- The output current when transfer output signal is set to 4 to 20 mA, the transfer output upper limit is set to 90.0, and the transfer output lower limit is set to 10.0 is shown in the following graph.
- For scaling from 0.0% to 100.0%, the output for -5.0 to 0.0 will be the same value as for 0.0%, and the output for 100.0 to 105.0 will be the same value as for 100.0%.

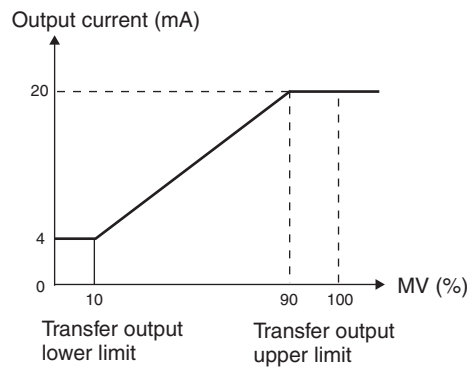



(The above graph is for when transfer output signal is set to 4 to 20 mA.)



Setting Example to Output 1 to 5 V for the Process Value (–50 to 200°C, Input Type 5)

Operating Procedure



- Setting the Transfer Output Signal Type

<p>1 Press the  Key several times in the Initial Setting Level to display <i>ERSt</i> (Transfer Output Signal Type).</p>	<p>Initial Setting Level</p> <div style="border: 1px solid black; padding: 5px; display: inline-block;"> <i>ERSt</i> <i>OFF</i> </div> <p>Transfer Output Signal Type</p>
<p>2 Press the  or  to select <i>1-5V</i> (1 to 5 V). The default is <i>4-20</i>.</p>	<div style="border: 1px solid black; padding: 5px; display: inline-block;"> <i>ERSt</i> <i>1-5V</i> </div>



- Setting the Transfer Output Type

<p>1 Press the  Key several times in the Initial Setting Level to display <i>ER-t</i> (Transfer Output Type).</p>	<p>Initial Setting Level</p> <div style="border: 1px solid black; padding: 5px; display: inline-block;"> <i>ER-t</i> <i>OFF</i> </div> <p>Transfer Output Type</p>
<p>2 Press the  or  Key to select <i>PV</i> (Process Value). The default is <i>OFF</i>.</p>	<div style="border: 1px solid black; padding: 5px; display: inline-block;"> <i>ER-t</i> <i>PV</i> </div>

- Setting the Transfer Output Upper Limit

<p>1 Press the  Key several times in the Initial Setting Level to display <i>ER-H</i> (Transfer Output Upper Limit).</p>	<p>Initial Setting Level</p> <div style="border: 1px solid black; padding: 5px; display: inline-block;"> <i>ER-H</i> <i>1300</i> </div> <p>Transfer Output Upper Limit</p>
<p>2 Press the  or  Key to set the value to 200. The default is 1300.</p>	<div style="border: 1px solid black; padding: 5px; display: inline-block;"> <i>ER-H</i> <i>200</i> </div>

- Setting the Transfer Output Lower Limit

<p>1 Press the  Key several times in the Initial Setting Level to display <i>ER-L</i> (Transfer Output Lower Limit).</p>	<p>Initial Setting Level</p> <div style="border: 1px solid black; padding: 5px; display: inline-block;"> <i>ER-L</i> <i>-200</i> </div> <p>Transfer Output Lower Limit</p>
<p>2 Press the  or  Key to set the value to –50. The default is –200.</p>	<div style="border: 1px solid black; padding: 5px; display: inline-block;"> <i>ER-L</i> <i>-50</i> </div>

6

Parameters

6-1	Conventions Used in this Section	6-2
6-2	Protect Level	6-3
6-3	Operation Level	6-7
6-4	Adjustment Level	6-16
6-5	Monitor/Setting Item Level	6-37
6-6	Manual Control Level	6-38
6-7	Initial Setting Level	6-40
6-8	Advanced Function Setting Level	6-62
6-9	Communications Setting Level	6-97

6-1 Conventions Used in this Section

● Meanings of Icons Used in this Section



Function

Describes the functions of the parameter.



Setting

Describes the setting range and default of the parameter.



Monitor

Used to indicate parameters used only for monitoring.



Operation

Describes the parameter settings, such as those for Operation Commands, and procedures.



See

Used to indicate information on descriptions in which the parameter is used or the names of related parameters.

● About Related Parameter Displays

Parameters are displayed only when the conditions for use given on the right of the parameter heading are satisfied. Protected parameters are not displayed regardless of the conditions for use, but the settings of these parameters are still valid.

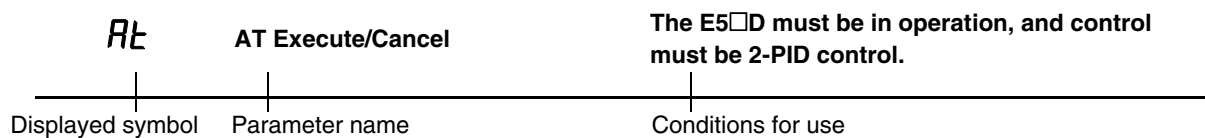

● The Order of Parameters in This Section

Parameters are described level by level.

The first page of each level describes the parameters in the level and the procedure to switch between parameters.

● Alarms

It will be specified in this section when alarms are set for the Control Output 1 or 2 Assignment parameters, or for the Auxiliary Output 1 to 4 Assignment parameters. For example, when alarm 1 is set for the Control Output 1 Assignment parameter, it will be specified that alarm 1 is assigned.

Assigning a work bit to either control output 1 or 2 or to auxiliary output 1 to 4 is also considered to be the same as assigning an alarm. For example, if work bit 1 is set for the Auxiliary Output 1 Assignment parameter, then alarms 1 to 4 have been assigned.

● Parameter Masking

The **MASK** mark appears for parameters that are masked in the default parameter mask settings.

Disable the mask to display the parameter. The **MASK8** mark appears for parameters that are masked only for the E5□D-□-8□□.

Refer to 5-12 *Hiding and Displaying Parameters*.

6-2 Protect Level

Four levels of protection are provided on the E5□D, operation/adjustment protect, initial setting/communications protect, setting change protect, and PF key protect. These protect levels prevent unwanted operation of the keys on the front panel in varying degrees.

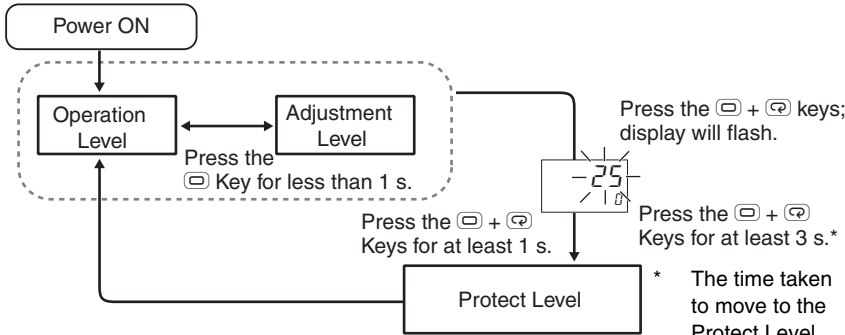

To move from the Operation Level or Adjustment Level to the Protect Level, press the [Enter] and [F] Keys for three seconds* or

Protect Level		Page
<i>PMōV</i> _[F]	Move to Protect Level Displayed only when a password is set.	6-3
<i>ōAPL</i> _[F]	Operation/Adjustment Protect	6-4
<i>ōōPL</i> _[F]	Initial Setting/Communications Protect	6-4
<i>WōPL</i> _{ōFF}	Setting Change Protect	6-5
<i>PFPL</i> _{ōFF}	PF Key Protect	6-5
<i>PMSH</i> _{ōN}	Parameter Mask Enable	6-5
<i>PRLP</i> _[F]	Password to Move to Protect Level MASK8	6-6

Press the [Enter] Key for at least one second to move to the previous parameter in the current setting level.

Parameters that are protected will not be displayed and their settings cannot be changed.

PMōV Move to Protect Level

The Password to Move to Protect Level password must not be set to 0.

The password to move to the Protect Level is entered for this parameter.



- If the correct password is entered, the Operation/Adjustment Protect parameter is displayed.



● **Related Parameters**

Password to Move to Protect Level (Protect Level): page 6-6

OPt Operation/Adjustment Protect

ICPt Initial Setting/Communications
Protect

These parameters specify the range of parameters to be protected.



● Operation/Adjustment Protect

Level		Set value			
		0 (default)	1	2	3
Operation Level	PV	Can be displayed	Can be displayed	Can be displayed	Can be displayed
	PV/SP	Can be displayed and changed	Can be displayed and changed	Can be displayed and changed	Can be displayed
	Others	Can be displayed and changed	Can be displayed and changed	Cannot be displayed and moving to other levels is not possible	Cannot be displayed and moving to other levels is not possible
Adjustment Level		Can be displayed and changed	Cannot be displayed and moving to other levels is not possible	Cannot be displayed and moving to other levels is not possible	Cannot be displayed and moving to other levels is not possible

- Parameters are not protected when the set value is set to 0.

● Initial Setting/Communications Protect

This protect level restricts movement to the Initial Setting Level, Communications Setting Level, and Advanced Function Setting Level.

Set value	Initial setting level	Communications setting level	Advanced function setting level
0	Possible to reach	Possible to reach	Possible to reach
1 (default)	Possible to reach	Possible to reach	Not possible to reach
2	Not possible to reach	Not possible to reach	Not possible to reach

WEPE Setting Change Protect

The Event Input Assignment 1 to Event Input Assignment 4 parameters must not be set to enable/disable setting changes.

Changes to settings using key operations are restricted.



- **Change Setting Protect**

This parameter is not displayed if the Event Input Assignment 1 to Event Input Assignment 4 parameters are set to enable/disable setting changes.



Set value	Description
OFF (default)	Settings can be changed using key operations.
ON	Settings cannot be changed using key operations. (The protect level settings, however, can be changed.)

- The all protect indication (**On**) will light when setting is ON.

PFPE PF Key Protect

- **PF Key Protect**

This parameter enables and disables PF Key operation.



Set value	Description
OFF (default)	PF Key enabled
ON	PF Key disabled (Operation as a function key is prohibited.)

PMSK Parameter Mask Enable

This parameter turns the parameter mask function ON and OFF.



Setting range	Default
$\bar{0}N$: Enabled, $\bar{0}FF$: Disabled	$\bar{0}N$

- * A parameter mask can be used to hide the displays of parameters that are not needed. You can set parameter masks with a key operation or with the Setup Tool.
Setup Tool: CX-Thermo (EST2-2C-MV4)





PRLP Password to Move to Protect Level

MASK8

This parameter is used to set the password to move to the Protect Level.



Function

To prevent setting the password incorrectly, the  and  Keys or  and  Keys must be pressed simultaneously to set the password.



Setting

Setting range	Default
-1999 to 9999	0

Set this parameter to 0 when no password is to be set.



- **Related Parameters**

Move to Protect Level (Protect Level): Page 6-3



Precautions for Correct Use

Protection cannot be cleared or changed without the password. Be careful not to forget it. If you forget the password, contact your OMRON sales representative.

6-3 Operation Level

Display this level to perform control operations on the E5□D. You can set alarm values, monitor the manipulated variable, and perform other operations in this level.

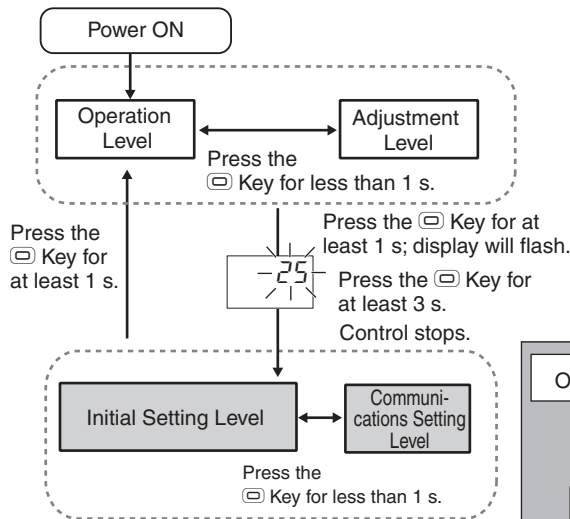

This level is displayed immediately after the power is turned ON.

Control in progress
 Control stopped

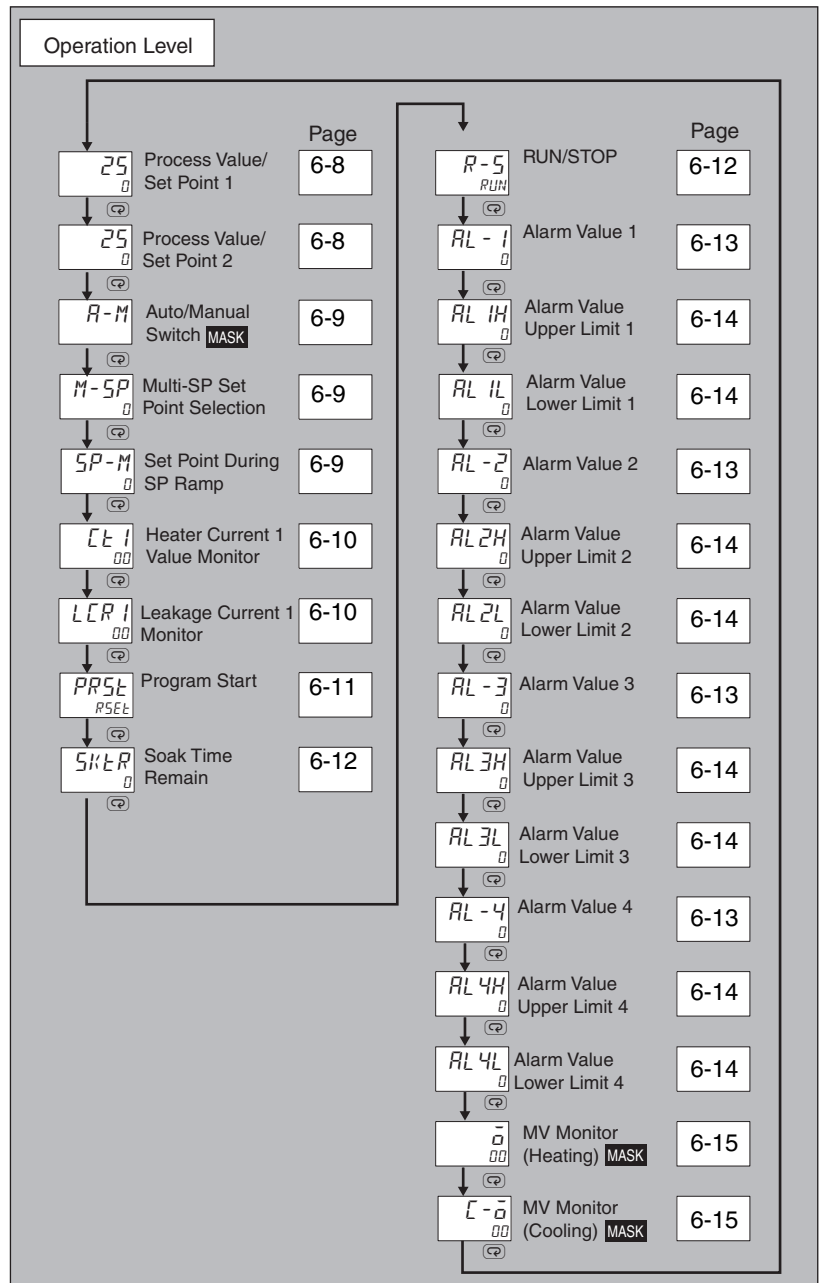

Process Value/Set Point 1

PV/SP No. 1 Display Selection must not be set to 0.

Process Value/Set Point 2

PV/SP No. 2 Display Selection must not be set to 0.



Function

The following table shows the contents of the No. 1, 2, and 3 displays, according to the setting of the PV/SP Display Screen Selection parameter.



Setting

Set value	No. 1 display	No. 2 display	No. 3 display (E5ED or E5ED-B only)
0	Nothing is displayed.	Nothing is displayed.	Nothing is displayed.
1	Process value	Set point	Nothing is displayed.
2	Process value	Nothing is displayed.	Nothing is displayed.
3	Set point	SP (character display)	Nothing is displayed.
4	Process value	Set point	MV (heating)
5	Process value	Set point	Multi-SP No.*
6	Process value	Set point	Soak time remain *
7	Process value	Set point	Internal set point (ramp SP)
8	Process value	Set point	Alarm value 1*
9	Process value	Set point	MV (cooling)*

* Nothing is displayed on the No. 1, 2, and 3 displays if the display conditions are not met.

	Monitor range	Unit
Process value	Temperature input: The specified range for the specified sensor. Analog input: Scaling lower limit -5% FS to Scaling upper limit +5% FS	EU

	Setting range	Unit
Set point	SP lower limit to SP upper limit	EU

For a temperature input, the decimal point position depends on the currently selected sensor, and for an analog input it depends on the Decimal Point parameter setting.

PV/SP Display Selections

Parameter	Default
PV/SP No. 1 Display Selection	4*
PV/SP No. 2 Display Selection	0

* The default is 1 for models other than the E5□D-□-8□□.



● Related Parameters

PV/SP Display Selection (Advanced Function Setting Level): Page 6-88

A-M Auto/Manual Switch

The Event Input Assignment 1 to 4 parameters must not be set to Auto/Manual.

The control must be set to 2-PID control.

MASK



Operation

- This parameter switches the Digital Controller between Automatic and Manual Modes.
- If the  Key is pressed for at least 3 seconds when the Auto/Manual Switch parameter is displayed, the Manual Mode will be entered and the manual control level will be displayed.
- This parameter will not be displayed if an event input is set to "MANU" (auto/manual).
- The default parameter mask settings mask (hide) this parameter.



● **Related Parameters**

PID ON/OFF (Initial Setting Level): Page 6-43

Parameter Mask Setting (Advanced Function Setting Level): Page 6-95

Parameter Mask Enable (Protect Level): 6-4

M-SP Multi-SP Set Point Selection (Set Points 0 to 7)

The Number of Multi-SP Points parameter must not be set to OFF and the Event Input Assignment 1 to Event Input Assignment 4 parameters must not be set to "Multi-SP No. switching bit 0" to "Multi-SP No. switching bit 2."



Function

To use the multi-SP function, preset up to eight set points (SP 0 to 7) in the Adjustment Level, and then switch the set point either by operating the keys or by using external input signals (event inputs).

This parameter is used to select set points 0 to 7.

SP-M Set Point During SP Ramp

The SP Ramp Set Value parameter must not be set to OFF and the SP Ramp Fall Value parameter must not be set to SAME or OFF.

This parameter monitors the set point during SP ramp operation.



Function

A ramp is used to restrict the change width of the set point as a rate of change.

This parameter is displayed when a set value is input for the SP Ramp Set Value parameter (Adjustment Level).

When not in ramp operation, the set point will be the same as the one displayed for the Process Value/Set Point parameter.



Monitor

Monitor range	Unit
SP: SP lower limit to SP upper limit	EU



● Related Parameters

- Process Value/Set Point (Operation Level): Page 6-8
- SP Ramp Set Value (Adjustment Level): Page 6-34
- SP Ramp Fall Value (Adjustment Level): Page 6-34
- Set Point Upper Limit (Initial Setting Level): Page 6-43
- Set Point Lower Limit (Initial Setting Level): Page 6-43

CT 1
Heater Current 1 Value Monitor
HB and HS alarms must be supported.
The HB ON/OFF parameter must be set to ON.

This parameter measures the heater current from the CT input used for detecting heater burnout.



This parameter measures and displays the heater current value.

- Heater burnout is not detected if the ON time for the control output for heating is 100 ms or less (30 ms or less if the control period is 0.1 or 0.2 s).



Monitor range	Unit
0.0 to 55.0	A

- *FFFF* is displayed when 55.0 A is exceeded.
- If an alarm is output for the Heater Burnout Detection 1 parameter, the No. 1 display will flash the Heater Current 1 Value Monitor parameter.



● Related Parameters

- Heater Burnout Detection 1 (Adjustment Level): Page 6-20
- HB ON/OFF (Advanced Function Setting Level): Page 6-66
- Error Display *CT 1*: Page A-18

LCR 1
Leakage Current 1 Monitor
HB and HS alarms must be supported.
The HS Alarm Use parameter must be set to ON.

This parameter measures the heater current from the CT input used for detecting SSR short-circuits.



The heater current is measured and the leakage current 1 monitor is displayed.

- The HS alarm is not detected if the OFF time for the control output for heating is 100 ms or less (38 ms or less if the control period is 0.1 or 0.2 s).



Monitor range	Unit
0.0 to 55.0	A

- *FFFF* is displayed when 55.0 A is exceeded.
- If an alarm is output for the HS Alarm 1 parameter, the No. 1 display will flash the Leakage Current 1 Monitor parameter.



● Related Parameters

- HS Alarm 1 (Adjustment Level): Page 6-21
- HS Alarm Use (Advanced Function Setting Level): Page 6-76
- Error Display *LCR 1*: Page A-18

PRSE Program Start

The Program Pattern parameter must not be set to OFF.

This parameter starts and stops the simple program function.



Function

- The RUN/STOP status will automatically switch to RUN when this parameter is set to START.
- The simple program will stop when this parameter is set to RSET.
- This parameter will function as a monitor display for the start/stop status of the simple program if an event input is selected to start the simple program.



Operation

Setting range		Default
RSET	Stops the simpler program.	<i>RSET</i>
STRT	Starts the simpler program.	



See

● **Related Parameters**

- Soak Time Remain (Operation Level): Page 6-12
- RUN/STOP (Operation Level): Page 6-12
- Soak Time (Adjustment Level): Page 6-32
- Wait Band (Adjustment Level): Page 6-32
- Program Pattern (Initial Setting Level): Page 6-48
- Soak Time Unit (Advanced Function Setting Level): Page 6-83

SKTR**Soak Time Remain****The Program Pattern parameter must not be set to OFF.**

This parameter measures and displays the remaining time of the soak time for the simple program function.



Monitor range	Unit
0 to 9999	min, h, or s



● **Related Parameters**

Program Start (Operation Level): Page 6-11

Soak Time (Adjustment Level): Page 6-32

Wait Band (Adjustment Level): Page 6-32

Program Pattern (Initial Setting Level): Page 6-48

Soak Time Unit (Advanced Function Setting Level): Page 6-83

R-S**RUN/STOP**

This parameter starts and stops the control operation.



When *RUN* (RUN) is selected, control is started. When *STOP* (STOP) is selected, control is stopped. The STOP indicator will light when control is stopped.

The default is *RUN*.



Precautions for Correct Use

For models with event inputs, the Event Input Assignment 2 parameter is set to RUN/STOP in the default settings. Even if you use key operations to set STOP, the Digital Controller will start in Run Mode when the power supply is turned ON if the event terminals are not connected.

AL - 1 Alarm Value 1**AL - 2** Alarm Value 2**AL - 3** Alarm Value 3**AL - 4** Alarm Value 4

Alarm 1 to alarm 4 must be assigned.
The Alarm 1 to 4 Type parameters must not be set to 0, 1, 4, 5, or 12.

This parameter is set to one of the input values "X" in *4-10-1 Alarm Types*.



- These parameters set the alarm values for alarms 1 to 4.
- During temperature input, the decimal point position depends on the currently selected sensor, and during analog input it depends on the Decimal Point parameter setting.

Alarms Other Than an MV Alarm

Setting range	Unit	Default
-1999 to 9999	EU	0

MV Alarms

Setting range	Unit	Default
-199.9 to 999.9	%	0.0



● Related Parameters

- Input Type (Initial Setting Level): Page 6-41
- Scaling Upper Limit, Scaling Lower Limit (Initial Setting Level), and Decimal Point (Initial Setting Level): Page 6-42
- Alarm 1 to 4 Type (Initial Setting Level): Page 6-50
- Alarm 1 to 4 Hysteresis (Initial Setting Level): Page 6-54
- Standby Sequence Reset (Advanced Function Setting Level): Page 6-65
- Auxiliary Output 1 to 4 Open in Alarm (Advanced Function Setting Level): Page 6-66
- Alarm 1 to 4 Latch (Advanced Function Setting Level): Page 6-71

AL 1H Alarm Value Upper Limit 1

AL 2H Alarm Value Upper Limit 2

AL 3H Alarm Value Upper Limit 3

AL 4H Alarm Value Upper Limit 4

AL 1L Alarm Value Lower Limit 1

AL 2L Alarm Value Lower Limit 2

AL 3L Alarm Value Lower Limit 3

AL 4L Alarm Value Lower Limit 4

Alarm 1 to alarm 4 must be assigned.
The Alarm 1 to 4 Type parameter must be set to 1, 4, or 5.

These parameters individually set the alarm value upper and lower limits when a mode for setting the upper and lower limits is selected for the Alarm 1 to 4 Type parameter (Initial Setting Level).



Function

- These parameters set the upper and lower limits for alarms 1 to 4.
- During temperature input, the decimal point position depends on the currently selected sensor, and during analog input it depends on the Decimal Point parameter setting.



Setting

Setting range	Unit	Default
-1999 to 9999	EU	0



See

● Related Parameters

Input Type (Initial Setting Level): Page 6-41

Scaling Upper Limit, Scaling Lower Limit, and Decimal Point (Initial Setting Level): Page 6-42

Alarm 1 to 4 Type (Initial Setting Level): Page 6-50

Alarm 1 to 4 Hysteresis (Initial Setting Level): Page 6-54

Standby Sequence Reset (Advanced Function Setting Level): Page 6-65

Auxiliary Output 1 to 4 Open in Alarm (Advanced Function Setting Level): Page 6-66

Alarm 1 to 4 Latch (Advanced Function Setting Level): Page 6-71

**MV Monitor (Heating)****MASK**

This parameter is used to monitor the manipulated variable for the heating control output during operation.



Function

- During standard control, the manipulated variable is monitored. During heating/cooling control, the manipulated variables on the control output (heating) is monitored.
- The default parameter mask settings mask (hide) this parameter.



Monitor

Control	Monitor range	Unit
Standard	-5.0 to 105.0	%
Heating/cooling	0.0 to 105.0	%



- **Related Parameters**

Parameter Mask Setting (Advanced Function Setting Level): Page 6-95

Parameter Mask Enable (Protect Level): Page 6-4

**MV Monitor (Cooling)**

The control system must be set to heating/cooling control.

MASK

This parameter is used to monitor the manipulated variable for the cooling control output during operation.



Function

- During heating/cooling control, the manipulated variable on the control output (cooling) is monitored.
- The default parameter mask settings mask (hide) this parameter.



Monitor

Control	Monitor range	Unit
Heating/cooling	0.0 to 105.0	%



- **Related Parameters**

Standard or Heating/Cooling (Initial Setting Level): Page 6-44

Parameter Mask Enable (Protect Level): Page 6-4

6-4 Adjustment Level

This level is for executing AT (auto-tuning) and other operations, and for set control parameters. This level provides the basic Digital Controller parameters for PID control (proportional band, integral time, derivative time) and heating/cooling control.

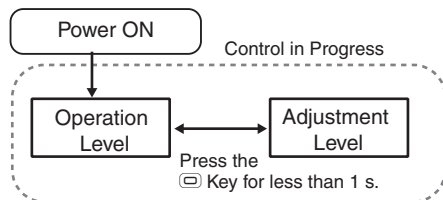

To move to the Adjustment Level from the Operation Level, press the [Key] once.

- The set points 0 to 7 in the Adjustment Level are the set values for switching the set point during multi-SP input.
- The following items are displayed for Digital Controllers with CT Inputs: Heater current monitors, Leakage current monitors, HB alarm detection, and HS alarm detection.
- Adjustment level parameters can be changed after setting the Operation/Adjustment Protect parameter to 0. Displays and changing levels are not possible if the Operation/Adjustment Protect parameter is set to 1 to 3. Protection is set in the Protect Level.

Adjustment Level		Page	Page	Page	Page
L.RdU	Adjustment Level Display MASK8	6-18	L.NRE	Process Value Slope Coefficient MASK8	6-23
RE	AT Execute/Cancel OFF	6-18	FR	Automatic Filter Adjustment OFF	6-23
CMWE	Communications Writing OFF	6-19	LNf	Input Digital Filter 0.0	6-24
Et	Heater Current 1 Value Monitor 0.0	6-19	R-Ud	PID Update (Adaptive Control) OFF	6-24
Hb	Heater Burnout Detection 1 0.0	6-20	W-HL	Water-cooling Output Adjustment OFF	6-25
LER	Leakage Current 1 Monitor 0.0	6-20	W-L	Water-cooling Proportional Band Increase Threshold 1.4	6-25
HS	HS Alarm 1 50.0	6-21	W-dL	Water-cooling Proportional Band Decrease Threshold 0.5	6-26
SP-0	SP 0	6-22	P	Proportional Band 8.0	6-26
SP-1	SP 1	6-22	L	Integral Time 233	6-26
SP-2	SP 2	6-22	d	Derivative Time 4.0	6-26
SP-3	SP 3	6-22	L-P	Proportional Band (Cooling) 8.0	6-27
SP-4	SP 4	6-22	L-L	Integral Time (Cooling) 233	6-27
SP-5	SP 5	6-22	L-d	Derivative Time (Cooling) 4.0	6-27
SP-6	SP 6	6-22	SP-P	SP Response Proportional Band 8.0	6-28
SP-7	SP 7	6-22	SP-L	SP Response Integral Time 233	6-28
LN5	Process Value Input Shift 0.0	6-23	SP-d	SP Response Derivative Time 4.0	6-28
			SP-N	SP Response Coefficient Number 0	6-28
			d-P	Disturbance Proportional Band 8.0	6-30
			d-L	Disturbance Integral Time 233	6-30
			d-d	Disturbance Derivative Time 4.0	6-30
			L-db	Dead Band 0.0	6-30
			oF-R	Manual Reset Value 50.0	6-31
			HYS	Hysteresis (Heating) 1.0	6-31
			CHYS	Hysteresis (Cooling) 1.0	6-31
			SoAK	Soak Time i	6-32
			Wt-b	Wait Band OFF	6-32
			MV-S	MV at Stop MASK	6-33
			MV-E	MV at PV Error MASK	6-33
			SPRE	SP Ramp Set Value OFF	6-34
			SPRL	SP Ramp Fall Value SAME MASK8	6-34
			oL-H	MV Upper Limit 100.0	6-34
			oL-L	MV Lower Limit 0.0	6-34
			oRL	MV Change Rate Limit 0.0 MASK8	6-35
			SoRP	Extraction of Square Root Low-cut Point 0.0	6-35
			W1oN	Work Bit 1 ON Delay 0	6-36
			W1oF	Work Bit 1 OFF Delay 000	6-36
			W2oN	Work Bit 2 ON Delay 000	6-36
			W2oF	Work Bit 2 OFF Delay 000	6-36
			W3oN	Work Bit 3 ON Delay 000	6-36
			W3oF	Work Bit 3 OFF Delay 000	6-36
			W4oN	Work Bit 4 ON Delay 000	6-36
			W4oF	Work Bit 4 OFF Delay 000	6-36
			W5oN	Work Bit 5 ON Delay 000	6-36
			W5oF	Work Bit 5 OFF Delay 000	6-36
			W6oN	Work Bit 6 ON Delay 000	6-36
			W6oF	Work Bit 6 OFF Delay 000	6-36
			W7oN	Work Bit 7 ON Delay 000	6-36
			W7oF	Work Bit 7 OFF Delay 000	6-36
			W8oN	Work Bit 8 ON Delay 000	6-36
			W8oF	Work Bit 8 OFF Delay 000	6-36
			PLCM	Communications Monitor 0	6-36

L.Adj Adjustment Level Display

MASK8

This parameter is displayed after moving to the Adjustment Level. The four numeric digits to identify the product code are displayed in the No. 2 display.

When a logic operation is set, a period "." will be displayed on the No. 2. display.



Function

- This parameter indicates that the Adjustment Level has been entered.
(The Adjustment Level parameter will not be displayed again even if the  Key is pressed in the Adjustment Level to scroll through the parameters.)

AT

AT Execute/Cancel

The RUN/STOP parameter must be set to RUN (default: RUN), control must be 2-PID control (default: PID).

This parameter executes auto-tuning (AT).



Function

- The MV is forcibly increased and decreased around the set point to find the characteristics of the control object. From the results, the PID constants are automatically set in the Proportional Band (P), Integral Time (I), and Derivative Time (D) parameters.
- Both 100% AT and 40% AT are supported for AT.
Only 100% AT can be executed for heating and cooling control.
- For heating/cooling control, select the tuning methods that is suitable for the cooling control characteristics in the Heating/Cooling Tuning Method parameter.
- If autotuning is performed with the default settings, the cooling PID constants (i.e., Proportional Band (Cooling), Integral Time (Cooling), and Derivative Time (Cooling) parameters) have the same values as the heating PID constants.



Operation

	Setting range	Default
OFF:	AT Cancel	
AT-2:	100%AT Execute	OFF
AT-1:	40%AT Execute	

- This parameter is normally $\bar{O}FF$. Press the  Key and select $AT-2$ or $AT-1$ to execute AT. AT cannot be executed when control is stopped or during ON/OFF control.
- The TUNE indicator will light during autotuning.
- When AT execution ends, the parameter setting automatically returns to $\bar{O}FF$.



See

- **Related Parameters**

RUN/STOP (Operation Level): Page 6-12

Proportional Band, Integral Time, and Derivative Time (Adjustment Level): Page 6-26

Proportional Band (Cooling), Integral Time (Cooling), and Derivative Time (Cooling) (Adjustment Level): Page 6-27

PID ON/OFF (Initial Setting Level): Page 6-43

Heating/Cooling Tuning Method (Advanced Function Setting Level): Page 6-85

CMWE Communications Writing

Communications must be supported.
The Event Input Assignment 1 to Event Input Assignment 4 parameters must not be set to enable/disable communications writing.



Function

- This parameter enables/disables writing of parameters to the E5□D from the host (personal computer) using communications.
- This parameter is not displayed if the Event Input Assignment 1 to Event Input Assignment 4 parameters are set to enable/disable communications writing.



Setting

Setting range		Default
ON:	Writing enabled	OFF
OFF:	Writing disabled	

- Writing with communications is enabled if you set the Protocol Setting parameter to Host Link (FINS), MC protocol (format 4), or dedicated protocol (format 4).



See

● Related Parameters

Communications Setting Level: Page 6-97
Protocol Setting, Communications Unit No., Communications Baud Rate,
Communications Data Length, Communications Parity, and Communications Stop Bits

EE1 Heater Current 1 Value Monitor

HB and HS alarms must be supported.
The HB ON/OFF parameter must be set to ON.

This parameter measures the heater current from the CT input used for detecting heater burnout.



Function

This parameter measures and displays the heater current value.

- Heater burnout is not detected if the ON time for the control output for heating is 100 ms or less (30 ms or less if the control period is 0.1 or 0.2 s).



Monitor

Monitor range	Unit
0.0 to 55.0	A

- FFFF is displayed when 55.0 A is exceeded.
- If an alarm is output for the Heater Burnout Detection 1 parameter, the No. 1 display will flash the Heater Current 1 Value Monitor parameter.



See

● Related Parameters

Heater Burnout Detection 1 (Adjustment Level): Page 6-20
HB ON/OFF (Advanced Function Setting Level): Page 6-66
Error Displays EE1: Page A-18

Hb 1**Heater Burnout Detection 1****HB and HS alarms must be supported.
The HB ON/OFF parameter must be set to ON.**

This parameter sets the current for the heater burnout alarm to be output.



- The heater burnout alarm is output when the heater current value falls below the setting of this parameter.
- When the set value is 0.0, the heater burnout alarm output is turned OFF. When the set value is 50.0, the heater burnout alarm output is turned ON.



Setting range	Unit	Default
0.0 to 50.0	A	0.0



● Related Parameters

- Heater Current 1 Value Monitor (Adjustment Level): Page 6-19
- Heater Burnout Detection (Advanced Function Setting Level): Page 6-66
- Heater Burnout Latch (Advanced Function Setting Level): Page 6-67
- Heater Burnout Hysteresis (Advanced Function Setting Level): Page 6-67

LCR 1**Leakage Current 1 Monitor****HB and HS alarms must be supported.
The HS Alarm Use parameter must be set to ON.**

This parameter measures the heater current from the CT input used for detecting SSR short-circuits.



- This parameter measures and displays the heater current when the heater is OFF.
- The HS alarm is not detected if the OFF time for the control output for heating is 100 ms or less (38 ms or less if the control period is 0.1 or 0.2 s).



Monitor range	Unit
0.0 to 55.0	A

- *FFFF* is displayed when 55.0 A is exceeded.
- If an alarm is output for the HS Alarm 1 parameter, the No. 1 display will flash the Leakage Current 1 Monitor parameter.



● Related Parameters

- HS Alarm 1 (Adjustment Level): Page 6-21
- HS Alarm Use (Advanced Function Setting Level): Page 6-76
- Error Displays *LCR 1*: Page A-18

HS 1 HS Alarm 1

**HB and HS alarms must be supported.
The HS Alarm Use parameter must be set to ON.**

This parameter sets the current for the HS alarm to be output.



- An HS alarm is output when the leakage current value exceeds the setting of this parameter.
- When the set value is 50.0, the HS alarm output is turned OFF. When the set value is 0.0, the HS alarm output is turned ON.



Setting range	Unit	Default
0.0 to 50.0	A	50.0



● **Related Parameters**

- Leakage Current 1 Monitor (Adjustment Level): Page 6-20
- HS Alarm (Advanced Function Setting Level): Page 6-76
- HS Alarm Latch (Advanced Function Setting Level): Page 6-77
- HS Alarm Hysteresis (Advanced Function Setting Level): Page 6-77

SP-0 SP 0*SP-1* SP 1*SP-2* SP 2*SP-3* SP 3*SP-4* SP 4*SP-5* SP 5*SP-6* SP 6*SP-7* SP 7

The Number of Multi-SP Points parameter must be set to 2 to 8 and the Event Input 1 Assignment to Event Input 4 Assignment parameters must not be set to “Multi-SP No. switching bit 0” to “Multi-SP No. switching bit 2.”

These parameters set the set points when the multi-SP function is used.



The values set in these parameters can be selected by operating the keys on the front panel or by using event inputs.

- When the set point has been changed, the set value of the set point (0 to 7) selected by the multi-SP inputs is also changed to the same value.
- The decimal point position depends on the selected sensor. During analog input, it depends on the Decimal Point parameter setting.



Setting range	Unit	Default
SP lower limit to SP upper limit	EU	0



● Related Parameters

Process Value/Set Point (Operation Level): Page 6-8

Input Type (Initial Setting Level): Page 6-41

Event Input Assignment (Initial Setting Level): Page 6-57

Number of Multi-SP Points (Advanced Function Setting Level): Page 6-64

**Process Value Input Shift**

Function

Sometimes an error occurs between the process value and the actual temperature. To offset this, a compensated value can be obtained by adding an input shift value to the input. The compensated value is displayed as the process value and used for control. The entire input range is shifted by a fixed rate. If the input shift value is set to -1°C , control will be performed for a value 1°C lower than the measured temperature.



Setting

Setting range	Unit	Default
Temperature input: -199.9 to 999.9	$^{\circ}\text{C}$ or $^{\circ}\text{F}$	0.0
Analog input: $-1,999$ to $9,999^*$	EU	0

* The decimal point position depends on the Decimal Point parameter setting.



See

- **Related Parameters**

Input Type (Initial Setting Level): Page 6-41

**Process Value Slope Coefficient**

MASK8



Function

This parameter sets a factor to apply to the input to compensate the process value. The resulting value is displayed as the process value and used in control.



Setting

Setting range	Default
0.001 to 9.999	1.000

**Automatic Filter Adjustment**

The Digital Controller must be in Run Mode (default: Run) and control must be standard control and 2-PID control.

This parameter performs automatic filter adjustment.



Function

Automatic filter adjustment is used to reduce temperature fluctuations in systems where there is cyclic disturbance, such as packaging machines.

The set value of the Input Digital Filter parameter is automatically adjusted.



Setting

Setting range	Default
$\bar{a}FF$: OFF / $\bar{a}N$: ON	$\bar{a}FF$

- **Related Parameters**



See

Input Digital Filter (Adjustment Level): Page 6-24

Automatic Filter Adjustment Seal Period (Advanced Function Setting Level): Page 6-92

Automatic Filter Adjustment Hunting Monitor Period (Advanced Function Setting Level): Page 6-93

INF Input Digital Filter



This parameter sets the time constant for the input digital filter. The following diagram shows the effect on data after passing through the digital filter.

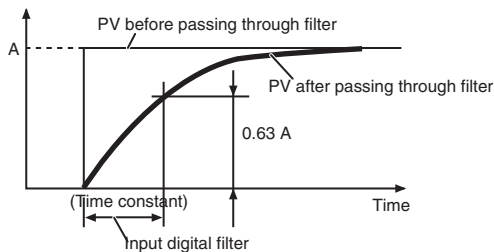

If the Automatic Filter Adjustment parameter in the Adjustment Level is set to ON, automatic filter adjustment will automatically set this parameter.



Setting range	Unit	Default
0.0 to 999.9	Seconds	0.0

R-Ud PID Update (Adaptive Control)

The control must be standard control and 2-PID control.
 The input type must be set for a temperature input.
 The Adaptive Control parameter must be set to “Notification.”
 It must be possible to update the PID constants with the values calculated by adaptive control.

This parameter updates the PID constants with values that are calculated with adaptive control.



This parameter is displayed if the Adaptive Control parameter is set to “Notification” and updateable PID constants are calculated. The PID constants are updated to the values calculated with system performance evaluation.



Setting range	Default
$\bar{a}FF$: OFF / $\bar{a}N$: Update	$\bar{a}FF$

● **Related Parameters**



Adaptive Control (Initial Setting Level): Page 6-45

W-HE**Water-cooling Output Adjustment**

The control must be set to heating/cooling control and 2-PID control.

The input type must be set for a temperature input. The Heating/Cooling Tuning Method must be set to “Water cooling.”

This parameter is used to enable or disable water-cooling output adjustment.



Function

- This parameter is used to suppress hunting caused by the water-cooling output from a water-cooled extrusion press.
- The set value of the Proportional Band (Cooling) parameter is automatically adjusted.



Setting

Setting range	Default
OFF: Disabled, ON: Enabled	OFF



See

- **Related Parameters**

Water-cooling Proportional Band Increase Threshold (Adjustment Level): Page 6-25

Water-cooling Proportional Band Decrease Threshold (Adjustment Level): Page 6-26

W-L**Water-cooling Proportional Band Increase Threshold**

The control must be set to heating/cooling control and 2-PID control.

The input type must be set for a temperature input. The Heating/Cooling Tuning Method must be set to “Water cooling.”

This parameter sets the threshold to detect hunting for water-cooling output adjustment.



Function

- This parameter sets the threshold for the temperature variation that is used to detect hunting. If the variation exceeds this threshold, the cooling proportional band is adjusted to reduce hunting.
- Normally, use the default for this parameter.



Setting

Setting range	Unit	Default
Water-cooling proportional band decrease threshold + 0.1 to 200.0	°C or °F	1.4



See

- **Related Parameters**

Water-cooling Output Adjustment (Adjustment Level): Page 6-25

W-dL**Water-cooling Proportional Band
Decrease Threshold**

The control must be set to heating/cooling control and 2-PID control.
The input type must be set for a temperature input.
The Heating/Cooling Tuning Method must be set to “Water cooling”.

This parameter sets the threshold to optimize disturbance response for water-cooling output adjustment.



Function

- This parameter sets the threshold to the temperature variation that is used to detect when disturbance response is not optimal.
- If the variation is less than or equal to this threshold, the cooling proportional band is adjusted to optimize disturbance response.
- Normally, use the default for this parameter.



Setting

Setting range	Unit	Default
0 to Water-cooling proportional band increase threshold - 0.1	°C or °F	0.6

● Related Parameters



See

Water-cooling Output Adjustment (Adjustment Level): Page 6-25

P**Proportional Band****I****Integral Time****d****Derivative Time**

Control must be set to 2-PID control. Either the Standard or Heating/Cooling parameter must be set to heating/cooling control or, if the Standard or Heating/Cooling parameter is set to standard control, adaptive control must be disabled.

These parameters set PID control constants. PID constants are automatically set when AT is executed.



Setting

- P** action: Refers to control in which the MV is proportional to the deviation (control error).
- I** action: Refers to a control action that is proportional to the time integral of the deviation. With proportional control, there is normally an offset (control error). Proportional action is thus used in combination with integral action. As time passes, this control error disappears, and the control temperature (process value) comes to agree with the set point.
- D** action: Refers to a control action that is proportional to the time derivative of the control error. The proportional control and integral control correct for errors in the control result, and thus the control system is late in responding to sudden changes in temperature. The derivative action increases the MV in proportion to the slope of the change in the temperature as a corrective action.



Parameter	Setting range		Unit	Default	
Proportional Band	Temperature input		°C	8.0	
					°F
	Analog input		%FS	10.0	
Integral Time *	Integral/Derivative Time Unit of 1 s	Standard or heating/cooling control	0 to 9999	Seconds	233
	Integral/Derivative Time Unit of 0.1 s	Standard or heating/cooling control	0.0 to 999.9	Seconds	233.0
Derivative Time *	Integral/Derivative Time Unit of 1 s		0 to 9999	Seconds	40
	Integral/Derivative Time Unit of 0.1 s		0.0 to 999.9	Seconds	40.0

* The unit is determined by the setting of the Integral/Derivative Time Unit parameter. The Proportional Band, Integral Time, and Derivative Time parameters are initialized if the Integral/Derivative Time Unit parameter is changed.



● Related Parameters

AT Execute/Cancel (Adjustment Level): Page 6-18

Integral/Derivative Time Unit (Advanced Function Setting Level): Page 6-68

[-P] Proportional Band (Cooling)

[-I] Integral Time (Cooling)

The control must be set to heating/cooling control and 2-PID control.

[-d] Derivative Time (Cooling)



These parameters set the PID constants for cooling control. These parameters are automatically set according to the Heating/Cooling Tuning Method parameter when AT is executed.



Parameter	Setting range		Unit	Default	
Proportional Band (Cooling)	Temperature input		°C	8.0	
					°F
	Analog input		%FS	10.0	
Integral Time (Cooling) *	Integral/Derivative Time Unit of 1 s	0 to 9999	Seconds	233	
	Integral/Derivative Time Unit of 0.1 s	0.0 to 999.9	Seconds	233.0	
Derivative Time (Cooling)*	Integral/Derivative Time Unit of 1 s		0 to 9999	Seconds	40
	Integral/Derivative Time Unit of 0.1 s		0.0 to 999.9	Seconds	40.0

* The unit is determined by the setting of the Integral/Derivative Time Unit parameter. The Proportional Band (Cooling), Integral Time (Cooling), and Derivative Time (Cooling) parameters are initialized if the Integral/Derivative Time Unit parameter is changed.



● Related Parameters

AT Execute/Cancel (Adjustment Level): Page 6-18

Integral/Derivative Time Unit (Advanced Function Setting Level): Page 6-68

<i>SP-P</i>	SP Response Proportional Band	The control must be standard control and 2-PID control.
<i>SP-I</i>	SP Response Integral Time	The input type must be set for a temperature input. The Adaptive Control parameter must be set to "Fixed."
<i>SP-d</i>	SP Response Derivative Time	

These parameters set the PID constants for set point response for use in adaptive control.



Function

- These parameters set the PID constants that are used during a transitional state in PID control.
- The set values of these parameters are automatically calculated when autotuning is executed while the Adaptive Control parameter is set to "Notification" or "Automatic update."
- This parameter is not displayed while the Adaptive Control parameter is set to "Notification" or "Automatic update." You can check the set value through communications.
- Do not change the set value of this parameter after it is calculated.



Setting

Parameter name	Setting range		Unit	Default
SP Response Proportional Band	0.1 to 999.9		°C	8.0
			°F	14.4
SP Response Integral Time	Integral/Derivative Time Unit of 1 s	0 to 9999	Seconds	233
	Integral/Derivative Time Unit of 0.1 s	0.0 to 999.9	Seconds	233.0
SP Response Derivative Time	Integral/Derivative Time Unit of 1 s	0 to 9999	Seconds	40
	Integral/Derivative Time Unit of 0.1 s	0.0 to 999.9	Seconds	40.0

● Related Parameters



Adaptive Control (Initial Setting Level): Page 6-45

SP-N**SP Response Coefficient Number**

The control must be standard control and 2-PID control.
The input type must be set for a temperature input.
The Adaptive Control parameter must be set to "Fixed."

This parameter is used for adaptive control.



Function

- This parameter sets the coefficient that is used during a transitional state in adaptive control.
- The set value of this parameter is automatically calculated when autotuning is executed while the Adaptive Control parameter is set to "Notification" or "Automatic update."
- This parameter is not displayed while the Adaptive Control parameter is set to "Notification" or "Automatic update." You can check the set value through communications.
- Do not change the set value of this parameter after it is calculated.



Setting

Setting range	Default
0 to 9999	0

● Related Parameters

Adaptive Control (Initial Setting Level): Page 6-45



See

$d-P$	Disturbance Proportional Band	The control must be standard control and 2-PID control.
$d-I$	Disturbance Integral Time	The input type must be set for a temperature input. The Adaptive Control parameter must be set to "Fixed."
$d-d$	Disturbance Derivative Time	

These parameters set the PID constants for disturbance for use in adaptive control.



Function

- These parameters set the PID constants that are used during a steady state in adaptive control.
- The set values of these parameters are automatically calculated when autotuning is executed while the Adaptive Control parameter is set to "Notification" or "Automatic update."
- This parameter is not displayed while the Adaptive Control parameter is set to "Notification" or "Automatic update." You can check the set value through communications.
- Do not change the set value of this parameter after it is calculated.



Setting

Parameter name	Setting range		Unit	Default
Disturbance Proportional Band	0.1 to 999.9		°C	8.0
			°F	14.4
Disturbance Integral Time	Integral/Derivative Time Unit of 1 s	0 to 9999	Seconds	233
	Integral/Derivative Time Unit of 0.1 s	0.0 to 999.9	Seconds	233.0
Disturbance Derivative Time	Integral/Derivative Time Unit of 1 s	0 to 9999	Seconds	40
	Integral/Derivative Time Unit of 0.1 s	0.0 to 999.9	Seconds	40.0

● Related Parameters



See

Adaptive Control (Initial Setting Level): Page 6-45

$I-db$	Dead Band	The control system must be set to heating/cooling control.
--------	-----------	--

This parameter sets the output dead band width for heating/cooling control. A negative setting sets an overlapping band.



Function

- This parameter sets an area in which the control output is 0 centering around the set point for a heating/cooling control.



Setting

	Setting range	Unit	Default
Temperature input	-199.9 to 999.9	°C	0.0
		°F	0.0
Analog input	-19.99 to 99.99	%FS	0.00

$\bar{O}F-R$ **Manual Reset Value**

The control must be standard control and 2-PID control. The integral time must be 0.



Function

This parameter sets the required manipulated variable to remove offset during stabilization of P or PD control.



Setting

Setting range	Unit	Default
0.0 to 100.0	%	50.0



● Related Parameters

Integral Time (Adjustment Level): Page 6-26

PID ON/OFF (Initial Setting Level): Page 6-43

 **HYS
 $[HYS]$** **Hysteresis (Heating)
Hysteresis (Cooling)**

The control must be ON/OFF control.
For the Hysteresis (Cooling) parameter, the control must be heating/cooling control.

This parameter sets the hysteresis for ensuring stable operation at the ON/OFF switching point.



Function

- For standard control, use the Hysteresis (Heating) parameter. The Hysteresis (Cooling) parameter cannot be used.
- For heating/cooling control, the hysteresis can be set independently for heating/cooling. The Hysteresis (Heating) parameter is used for the heating side, and the Hysteresis (Cooling) parameter is used for the cooling side.



Setting

Parameter name	Setting range		Unit	Default
Hysteresis (Heating)	Temperature input	0.1 to 999.9	°C	1.0
			°F	1.8
Hysteresis (Cooling)	Analog input	0.01 to 99.99	%FS	0.10
	Temperature input	0.1 to 999.9	°C	1.0
			°F	1.8
Analog input	0.01 to 99.99	%FS	0.10	



● Related Parameters

PID ON/OFF (Initial Setting Level): Page 6-43

Standard or Heating/Cooling (Initial Setting Level): Page 6-44

Soak**Soak Time****The Program Pattern parameter must not be set to OFF.**

This parameter sets the time for the control operation when using the simple program function.



Setting range	Unit	Unit
1 to 9999	s, min, or h	1



● Related Parameters

- Program Start (Operation Level): Page 6-11
- Soak Time Remain (Operation Level): Page 6-12
- Wait Band (Adjustment Level): Page 6-32
- Program Pattern (Initial Setting Level): Page 6-48
- Soak Time Unit (Advanced Function Setting Level): Page 6-83

WT - b**Wait Band****The Program Pattern parameter must not be set to OFF.**

This parameter sets the stable band within which the soak time is measured for the simple program function.



	Setting range	Unit	Unit
Temperature input	OFF or 0.1 to 999.9	°C or °F	off
Analog input	OFF or 0.01 to 99.99	%FS	



● Related Parameters

- Program Start (Operation Level): Page 6-11
- Soak Time Remain (Operation Level): Page 6-12
- Soak Time (Adjustment Level): Page 6-32
- Program Pattern (Initial Setting Level): Page 6-48
- Soak Time Unit (Advanced Function Setting Level): Page 6-83

MV-5**MV at Stop****The control must be set to 2-PID control.****MASK**

Function

- This parameter sets the MV to use when the RUN/STOP status changes from RUN to STOP.
- The default parameter mask settings mask (hide) this parameter.



Setting

Control method	Setting range	Unit	Default
Standard	-5.0 to 105.0	%	0.0
Heating and cooling	-105.0 to 105.0		



See

- **Related Parameters**

RUN/STOP (Operation Level): Page 6-12

Parameter Mask Setting (Advanced Function Setting Level): Page 6-95

Parameter Mask Enable (Protect Level): Page 6-4

MV-E**MV at PV Error****The control must be set to 2-PID control.****MASK**

Function

- This parameter sets the MV to use when an input error occurs.
- The default parameter mask settings mask (hide) this parameter.



Setting

Control method	Setting range	Unit	Default
Standard	-5.0 to 105.0	%	0.0
Heating and cooling	-105.0 to 105.0		



See

- **Related Parameters**

Parameter Mask Setting (Advanced Function Setting Level): Page 6-95

Parameter Mask Enable (Protect Level): Page 6-4

SPRt SP Ramp Set Value

SPRL SP Ramp Fall Value **MASK8**



Function

- These parameters set the rate of change during SP ramp operation. They set the maximum permissible change width per unit of time as the SP ramp set value and the SP ramp fall value. The SP ramp function is disabled if this parameter is set to OFF.
- For a temperature input, the decimal point positions of the SP ramp set value and SP ramp fall value depend on the currently selected sensor, and for an analog input they depend on the Decimal Point parameter.



Setting

Parameter	Setting range	Unit	Default
SP Ramp Set Value	OFF or 1 to 9,999	EU/s, EU/ min, EU/h	OFF
SP Ramp Fall Value	SAME (Same as SP ramp set value), OFF or 1 to 9,999	EU/s, EU/ min, EU/h	SAME

oL-H MV Upper Limit

The control must be set to 2-PID control.

oL-L MV Lower Limit



Function

The MV Upper Limit and MV Lower Limit parameters set the upper and lower limits of the manipulated variable. When the calculated manipulated variable exceeds the upper or lower limit value, the upper or lower limit value will be the output level.



Setting

- MV Upper Limit

Control method	Setting range	Unit	Default
Standard	MV lower limit + 0.1 to 105.0	%	100.0
Heating/cooling control	0.0 to 105.0		

- MV Lower Limit

The MV for the cooling control output during heating/cooling control is expressed as a negative value.

Control method	Setting range	Unit	Default
Standard	-5.0 to MV upper limit - 0.1	%	0.0
Heating/cooling control	-105.0 to 0.0		-100.0



See

● Related Parameters

PID ON/OFF (Initial Setting Level): Page 6-43

CR**MV Change Rate Limit****The control must be set to 2-PID control.****MASK8**

- The MV Change Rate Limit parameter sets the maximum allowable variation in the MV per second. If the change in the MV exceeds this setting, the MV will be changed by the MV change rate limit until the calculated value is reached. If the limit is set to 0.0, this function will be disabled.
- The MV Change Rate Limit parameter will not operate in the following situations.
 - In Manual Mode
 - During AT execution
 - During ON/OFF control
 - While stopped (MV output during STOP)
 - During MV output when error occurs



Setting range	Unit	Default
0.0 to 100.0	%/s	0.0



- **Related Parameters**

Proportional Band (Adjustment Level): Page 6-26

SQRP**Extraction of Square Root Low-cut Point****The input type must be an analog input, and the Extraction of Square Root Enable parameter must be set to ON.**

- This parameter sets the extraction of square root low-cut point used for the inputs. The data after extracting the square root is shown below.
- The low-cut point is used for extracting the square root for flowrate sensors.

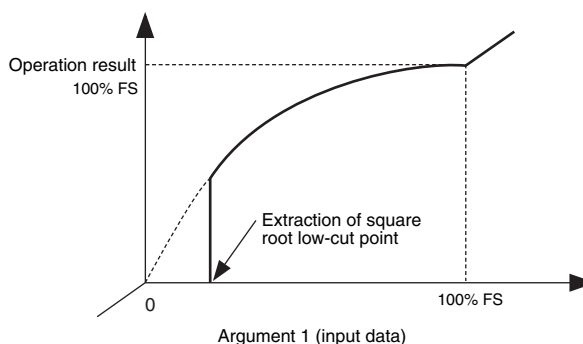

Setting range	Unit	Default
0.0 to 100.0	%	0.0



- **Related Parameters**

Extraction of Square Root Enable (Initial Setting Level): Page 6-59

W1 to B \bar{O} NWork Bit 1 to 8 ON Delay **000**

The work bit operation type must not be set to OFF.

W1 to B \bar{O} FWork Bit 1 to 8 OFF Delay **000**

Function

- ON Delay
When the results of a work bit logic operation is ON, the work bit is turned ON after the time specified in the parameter elapses.
- OFF Delay
When the results of a work bit logic operation is OFF, the work bit is turned OFF after the time specified in the parameter elapses.



Setting

Setting range	Unit	Default
0 to 9999	Seconds*	0

* The unit can be changed to minutes on the CX-Thermo Logic Operation Editor Setting Window.



See

● Related Parameters

Auxiliary Output 1 to 4 Assignment (Advanced Function Setting Level): Page 6-81

PLCM

Communications Monitor

Communications must be supported.

The Protocol Setting parameter must be set to Host Link (FINS) or the MC Protocol.



Function

- The Communications Monitor parameter displays the communications cycle time of the E5□D.
- If communications are not possible with the PLC, $\overline{L.ERR}$ is displayed. When communications are restored, the cycle time is displayed again.



Setting

Monitoring range	Default
Normal: 0 to 9999 ms, If 9999 ms is exceeded: $\overline{L.ERR}$ Error: $\overline{L.ERR}$	---

Also refer to the *E5□D Digital Controllers Communications Manual* (Cat. No. H225) for information on communications.

6-5 Monitor/Setting Item Level

Monitor/setting items can be displayed by means of the function key when the PF Setting parameter (Advanced Function Setting Level) is set to PFDP: Monitor/Setting Item.

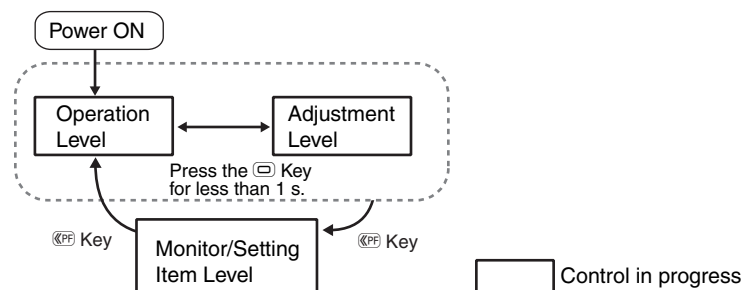

PFd 1 to 5 Monitor/Setting Item Display 1 to 5

The PF Setting parameter must be set to PFDP, and the Monitor/Setting Item 1 to 5 parameters must not be set to OFF.

- When the PF Key is set to display monitor/setting items, pressing the PF Key will display in order the contents of the Monitor/Setting Item 1 to 5 parameters. The contents of these parameters are shown in the following table. For the setting (monitor) ranges, refer to the applicable parameters.

Set value	Setting ^{*2}	Remarks	
		Monitor/Setting	Display
0	Disabled	---	---
1	PV/SP/Multi-SP	Can be set. (SP) ^{*1}	---
2	PV/SP/MV (Heating)	Can be set. (SP) ^{*1}	---
3	PV/SP /Soak time remain	Can be set. (SP) ^{*1}	---
4	Proportional band (P)	Can be set.	<i>P</i>
5	Integral time (I)	Can be set.	<i>I</i>
6	Derivative time (D)	Can be set.	<i>d</i>
7	Alarm value 1	Can be set.	<i>AL - 1</i>
8	Alarm value upper limit 1	Can be set.	<i>AL 1H</i>
9	Alarm value lower limit 1	Can be set.	<i>AL 1L</i>
10	Alarm value 2	Can be set.	<i>AL - 2</i>
11	Alarm value upper limit 2	Can be set.	<i>AL 2H</i>
12	Alarm value lower limit 2	Can be set.	<i>AL 2L</i>
13	Alarm value 3	Can be set.	<i>AL - 3</i>
14	Alarm value upper limit 3	Can be set.	<i>AL 3H</i>
15	Alarm value lower limit 3	Can be set.	<i>AL 3L</i>
16	Alarm value 4	Can be set.	<i>AL - 4</i>
17	Alarm value upper limit 4	Can be set.	<i>AL 4H</i>
18	Alarm value lower limit 4	Can be set.	<i>AL 4L</i>
19	PV/SP/Internal SP	Can be set. (SP) ^{*1}	---
20	PV/SP/Alarm Value 1	Can be set. (SP) ^{*1}	---
21	Proportional Band (Cooling)	Can be set.	<i>[-P</i>
22	Integral Time (Cooling)	Can be set.	<i>[-I</i>
23	Derivative Time (Cooling)	Can be set.	<i>[-d</i>
24	PV/SP/MV (Cooling)	Can be set. (SP) ^{*1}	---

*1 With the E5CD or E5CD-B, only the PV and SP can be displayed.

*2 If the display condition is not met for even one of the set parameters, the monitor/setting item display will not appear.

6-6 Manual Control Level

If you change to Manual Mode, the Manual MV parameter will be displayed and the displayed value will be output as the MV. You must first display the Auto/Manual Switch parameter (*R-M*). The Auto/Manual Switch parameter is masked by default. Refer to *5-12 Hiding and Displaying Parameters*.

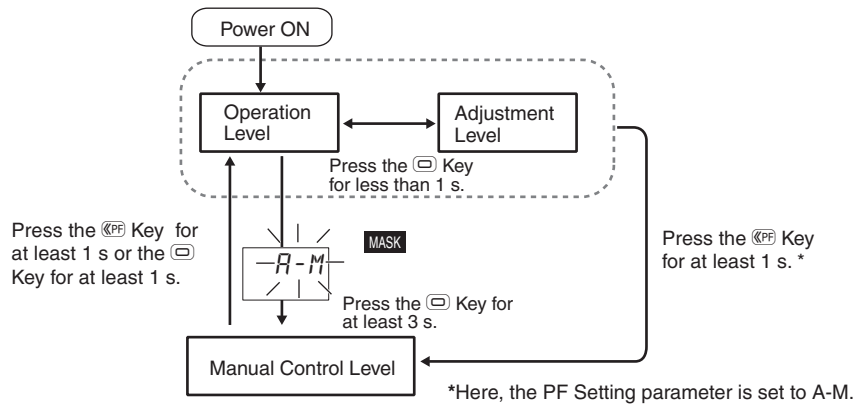

For details on the setting method, refer to *5-16 Performing Manual Control*.

- The MANU indicator will light during manual control.
- It is not possible to move to any parameters except for the PV/MV parameter during manual operation.

PV/MV (Manual MV)

The control must be set to 2-PID control.



- The manual control level display appears as shown below.

E5ED or E5ED-B

E5CD or E5CD-B

PV/SP/Manual MV

PV/Manual MV

	Monitor range	Unit
Process value	Temperature: According to indication range for each sensor. Analog: Scaling lower limit -5% FS to Scaling upper limit +5% FS (Refer to A-8 Sensor Input Setting Range, Indication Range, Control Range.)	EU
Set point	SP lower limit to SP upper limit	EU

	Setting range		Default	Unit
MV (Manual MV)	Standard control	-5.0 to 105.0*	0.0	%
	Heating/cooling control	-105.0 to 105.0*		

* When the Manual MV Limit Enable parameter is set to ON, the setting range will be the MV lower limit to the MV upper limit.



- Related Parameters**

5-16 Performing Manual Control: Page 5-56

Standard or Heating/Cooling (Initial Setting Level): Page 6-44

6-7 Initial Setting Level

This level is used to set up the basic Digital Controller specifications. In this level, you can set the Input Type parameter to set the sensor input to be connected, limit the setting range of set points, set the alarm modes, and perform other operations.

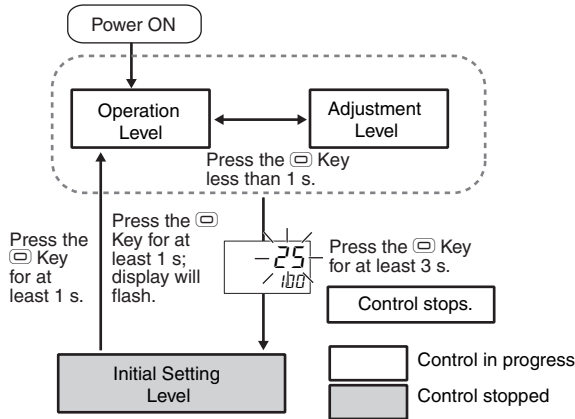

To move from the Operation Level or Adjustment Level to the Initial Setting Level, press the ☐ Key for at least three seconds with any parameter displayed except for the Auto/Manual Switch parameter.

- The Initial Setting Level is not displayed when the Initial Setting/Communications Protect parameter is set to 2. It can be used when the Initial Setting/Communications Protect parameter is set to 0 or 1.
- If the Input Type parameter is set for an analog input, the following parameters will be set: Scaling upper limit, Scaling lower limit, and Decimal point.

Initial Setting Level						Page	
CN-L 5	Input Type	Page	6-41	PERN OFF MASK8	Program Pattern	Page	6-48
CN-H 100	Scaling Upper Limit	Page	6-42	CP 20	Control Period (Heating)	Page	6-49
CN-L 0	Scaling Lower Limit	Page	6-42	C-CP 20	Control Period (Cooling)	Page	6-49
dP 0	Decimal Point	Page	6-42	aREV aR-P	Direct/Reverse Operation	Page	6-50
d-U C	Temperature Unit	Page	6-42	RL1 2	Alarm 1 Type	Page	6-50
SL-H 1300	SP Upper Limit	Page	6-43	RLH1 0.2	Alarm 1 Hysteresis	Page	6-54
SL-L -200	SP Lower Limit	Page	6-43	RL2 2	Alarm 2 Type	Page	6-50
CNEL P.C.d	PID-ON/OFF	Page	6-43	RLH2 0.2	Alarm 2 Hysteresis	Page	6-54
S-HL St.Hd	Standard or Heating/Cooling	Page	6-44	RL3 2	Alarm 3 Type	Page	6-50
AdPE OFF	Adaptive Control	Page	6-45	RLH3 0.2	Alarm 3 Hysteresis	Page	6-54
M-PV 0.00	Model Creation PV Amplitude	Page	6-46	RL4 2	Alarm 4 Type	Page	6-50
M-MV 0.0	Model Creation MV Amplitude	Page	6-46	RLH4 0.2	Alarm 4 Hysteresis	Page	6-54
M-ON 0	Model Creation ON Time	Page	6-47	a1SE 4-20	Control Output 1 Signal	Page	6-55
M-OFF 0	Model Creation OFF Time	Page	6-47	TRSE 4-20	Transfer Output Signal	Page	6-55
				TR-L OFF	Transfer Output type	Page	6-55
				TR-H 100.0	Transfer Output Upper Limit	Page	6-56
				TR-L 0.0	Transfer Output Lower Limit	Page	6-56
				EV-1 MSPO	Event Input Assignment 1	Page	6-57
				EV-2 StOP	Event Input Assignment 2	Page	6-57
				EV-3 HdNE	Event Input Assignment 3	Page	6-57
				EV-4 HdNE	Event Input Assignment 4	Page	6-57
				EV-5 HdNE	Event Input Assignment 5	Page	6-57
				EV-6 HdNE	Event Input Assignment 6	Page	6-57
				SQR OFF	Extraction of Square Root Enable	Page	6-59
				P-ON CONE	Operation After Power ON	Page	6-59
				bAR MV	Bar Display Data	Page	6-60
				bARH 100.0	Bar Display Scaling Upper Limit	Page	6-60
				bARL 0.0	Bar Display Scaling Lower Limit	Page	6-60
				RMov 0	Move to Advanced Function Setting Level	Page	6-61

IN-E Input Type



Function

- The Input Type parameter is used to set the input type.
- When this parameter is changed, the set point limiter is changed to the defaults. If the limiter must be specified, set the SP Upper Limit and SP Lower Limit parameters (Initial Setting Level) again.
- If a resistance thermometer is mistakenly connected while a setting for other than a resistance thermometer is in effect, *S.ERR* will be displayed. To clear the *S.ERR* display, check the wiring and then cycle the power.



Setting

Input type	Sensor specification	Set value	Temperature range in °C	Temperature range in °F	
Temperature input	Resistance thermometer	Pt100	0	-200 to 850	-300 to 1500
			1	-199.9 to 500.0	-199.9 to 900.0
		2	0.0 to 100.0	0.0 to 210.0	
		JPt100	3	-199.9 to 500.0	-199.9 to 900.0
			4	0.0 to 100.0	0.0 to 210.0
	Thermocouple	K	5 (default)	-200 to 1300	-300 to 2300
			6	-20.0 to 500.0	0.0 to 900.0
		J	7	-100 to 850	-100 to 1500
			8	-20.0 to 400.0	0.0 to 750.0
		T	9	-200 to 400	-300 to 700
			10	-199.9 to 400.0	-199.9 to 700.0
		E	11	-200 to 600	-300 to 1100
		L	12	-100 to 850	-100 to 1500
		U	13	-200 to 400	-300 to 700
			14	-199.9 to 400.0	-199.9 to 700.0
		N	15	-200 to 1300	-300 to 2300
		R	16	0 to 1700	0 to 3000
		S	17	0 to 1700	0 to 3000
		B	18	0 to 1800	0 to 3200
		C/W	19	0 to 2300	0 to 3200
PLII	20	0 to 1300	0 to 2300		
Analog input	Infrared Temperature Sensor ES1B	10 to 70°C	21	0 to 90	0 to 190
		60 to 120°C	22	0 to 120	0 to 240
		115 to 165°C	23	0 to 165	0 to 320
		140 to 260°C	24	0 to 260	0 to 500
	Current input	4 to 20 mA	25	One of the following ranges according to the scaling: -1999 to 9999 -199.9 to 999.9 -19.99 to 99.99 -1.999 to 9.999	
		0 to 20 mA	26		
	Voltage input	1 to 5 V	27		
		0 to 5 V	28		
		0 to 10V	29		



See

● Related Parameters

Temperature Unit (Initial Setting Level): Page 6-42

Set Point Upper Limit and Set Point Lower Limit (initial Setting Level): Page 6-43

$\bar{L}N-H$ **Scaling Upper Limit**

$\bar{L}N-L$ **Scaling Lower limit**

The input type must be set for an analog input.

dP **Decimal Point**



Function

- The Decimal Point parameter specifies the decimal point position of parameters (set point, etc.) whose unit is EU.



Setting

- Scaling Upper Limit, Scaling Lower Limit

Parameter name	Setting range	Default
Scaling Upper Limit	Scaling lower limit + 1 to 9999	100
Scaling Lower Limit	-1999 to scaling upper limit - 1	0

- Decimal Point

Parameter name	Setting range	Default
Decimal Point	0 to 3	0

Set value	Settings	Example
0	0 digits past decimal point	1234
1	1 digits past decimal point	123.4
2	2 digits past decimal point	12.34
3	3 digits past decimal point	1.234



● Related Parameters

Input Type (Initial Setting Level): Page 6-41

$d-U$ **Temperature Unit**

The input type must be set for a temperature input.



Function

- Set the temperature input unit to either °C or °F.
- If you change the temperature unit, the units of temperature set values (e.g., the alarm values) will be automatically converted.



Setting

Setting range	Default
\bar{L} : °C, F: °F	\bar{L}



● Related Parameters

Input Type (Initial Setting Level): Page 6-41

SL-H SP Upper Limit**SL-L** SP Lower Limit

- These parameters set the upper and lower limits of the set points. A set point can be set within the range defined by the upper and lower limit set values in the SP Upper Limit and SP Lower Limit parameters. If these parameters are reset, any set point that is outside of the new range will be forcibly changed to either the upper limit or the lower limit.
- When the temperature input type and temperature unit have been changed, the set point upper limit and set point lower limit are forcibly changed to the upper and lower limits of the sensor.
- For a temperature input, the decimal point position depends on the currently selected sensor, and for an analog input it depends on the Decimal Point parameter setting.



Parameter name		Setting range	Unit	Default
Set Point Upper Limit	Temperature input	SP lower limit + 1 to Input setting range upper limit	EU	1300
	Analog input	SP lower limit + 1 to scaling upper limit	EU	100
Set Point Lower Limit	Temperature input	Input setting range lower limit to SP upper limit - 1	EU	-200
	Analog input	Scaling lower limit to SP upper limit - 1	EU	0



● Related Parameters

- Input Type (Initial Setting Level): Page 6-41
- Temperature Unit (Initial Setting Level): Page 6-42

ENL PID ON/OFF

- This parameter selects 2-PID control or ON/OFF control.
- Auto-tuning can be used in 2-PID control.



Setting range	Default
P_{Ld} : 2-PID, $\bar{a}N\bar{o}F$: ON/OFF	P_{Ld}



● Related Parameters

- AT Execute/Cancel (Adjustment Level): Page 6-18
- Manual Reset Value (Adjustment Level): Page 6-31
- Hysteresis (Heating) and Hysteresis (Cooling) (Adjustment Level): Page 6-31

S-HC Standard or Heating/Cooling



- This parameter selects standard control or heating/cooling control.
 - If heating/cooling control is selected for the E5CD or E5CD-B, the auxiliary output 2 terminal is assigned as the control output for cooling.
 - If heating/cooling control is selected for the E5ED or E5ED-B when there is only one control output, the auxiliary output 4 terminal is assigned as the control output for cooling.
- Note: If standard control is selected, set the Control Output 1 Assignment to \bar{a} (control output (heating)) for either direct (cooling) or reverse (heating) operation.



Setting range	Default
<i>S_{ENd}</i> : Standard, <i>H-C</i> : Heating/cooling	<i>S_{ENd}</i>



● Related Parameters

MV Monitor (Heating) (Operation Level): Page 6-15

MV Monitor (Cooling) (Operation Level): Page 6-15

Dead Band (Adjustment Level): Page 6-30

Hysteresis (Heating) and Hysteresis (Cooling) (Adjustment Level): Page 6-31

Control Period (Heating) and Control Period (Cooling) (Initial Setting Level): Page 6-49

Control Output 1 and 2 Assignment (Advanced Function Setting Level): Page 6-80

Auxiliary Output 1 to 4 Assignment (Advanced Function Setting Level): Page 6-81

AdPt Adaptive Control

The control must be set to standard control and 2-PID control and the input type must be a temperature input.

This parameter sets the operation of adaptive control.



Function

- Disabled: Adaptive control is disabled. Operation uses 2-PID control.
- Fixed: System performance evaluation is not performed. Use this setting when you do not want to update adaptive control PID values.
- Notification: System performance evaluation is performed and if temperature variations occur in the system, the **A** indicator will light to notify the user. If the fluctuation is small, the **A** indicator will not light, but the calculated adaptive control PID constants will be used. To update the adaptive control PID values, set the PID Update parameter to “Update (ON).”
- Automatic update: System performance evaluation is performed and the adaptive control PID constants are updated automatically.



Setting

	Setting range	Default
$\bar{a}FF$	Disabled.	$\bar{a}FF$
$F\bar{L}X$	Fixed	
$\bar{L}NF\bar{a}$	Notification	
$RUL\bar{a}$	Automatic update	

● Related Parameters



See

- PID Update (Adaptive Control) (Adjustment Level): Page 6-24
- Adaptive Control Operation Possible Deviation (Advanced Function Setting Level): Page 6-91
- System Fluctuation Reference Deviation (Advanced Function Setting Level): Page 6-92
- Model Creation PV Amplitude (Adjustment Level): Page 6-46
- Model Creation MV Amplitude (Adjustment Level): Page 6-46
- Model Creation ON Time (Adjustment Level): Page 6-47
- Model Creation OFF Time (Adjustment Level): Page 6-47
- SP Response Proportional Band (Adjustment Level): Page 6-28
- SP Response Integral Time (Adjustment Level): Page 6-28
- SP Response Derivative Time (Adjustment Level): Page 6-28
- Disturbance Proportional Band (Adjustment Level): Page 6-29
- Disturbance Integral Time (Adjustment Level): Page 6-30
- Disturbance Derivative Time (Adjustment Level): Page 6-30

M-PV**Model Creation PV Amplitude**

The control must be standard control and 2-PID control.

The input type must be set for a temperature input. The Adaptive Control parameter must not be set to "Disabled."

This is one of the model parameters used for adaptive control. It expresses the PV variation characteristic of the system.

This parameter is copied so that another Digital Controller can inherit the measured system characteristics.



Function

- The set value of this parameter is automatically calculated when autotuning is executed while the Adaptive Control parameter is set to "Notification" or "Automatic update."
- Do not change the set value of this parameter after it is calculated.



Setting

Setting range	Unit	Default
0.00 to 99.99	%FS	0.00

● Related Parameters



See

Adaptive Control (Initial Setting Level): Page 6-45

M-MV**Model Creation MV Amplitude**

The control must be standard control and 2-PID control.

The input type must be set for a temperature input. The Adaptive Control parameter must not be set to "Disabled."

This is one of the model parameters used for adaptive control. It expresses the MV variation characteristic of the system.

This parameter is copied so that another Digital Controller can inherit the measured system characteristics.



Function

- The set value of this parameter is automatically calculated when autotuning is executed while the Adaptive Control parameter is set to "Notification" or "Automatic update."
- Do not change the set value of this parameter after it is calculated.



Setting

Setting range	Unit	Default
0.0 to 100.0	%FS	0.0

● Related Parameters



See

Adaptive Control (Initial Setting Level): Page 6-45

M- $\bar{O}N$ Model Creation ON Time

The control must be standard control and 2-PID control.
The input type must be set for a temperature input.
The Adaptive Control parameter must not be set to "Disabled."

This is one of the model parameters used for adaptive control. It expresses the ON time characteristic of the system.

This parameter is copied so that another Digital Controller can inherit the measured system characteristics.



Function

- The set value of this parameter is automatically calculated when autotuning is executed while the Adaptive Control parameter is set to "Notification" or "Automatic update."
- Do not change the set value of this parameter after it is calculated.



Setting

Setting range	Unit	Default
0 to 9999	---	0

● **Related Parameters**



See

Adaptive Control (Initial Setting Level): Page 6-45

M- $\bar{O}F$ Model Creation OFF Time

The control must be standard control and 2-PID control.
The input type must be set for a temperature input.
The Adaptive Control parameter must not be set to "Disabled."

This is one of the model parameters used for adaptive control. It expresses the OFF time characteristic of the system.

This parameter is copied so that another Digital Controller can inherit the measured system characteristics.



Function

- The set value of this parameter is automatically calculated when autotuning is executed while the Adaptive Control parameter is set to "Notification" or "Automatic update."
- Do not change the set value of this parameter after it is calculated.



Setting

Setting range	Unit	Default
0 to 9999	---	0

● **Related Parameters**



See

Adaptive Control (Initial Setting Level): Page 6-45

PERN Program Pattern

MASK8

This parameter sets the type of control when using the simple program function.



- If the program pattern is set to \bar{OFF} , the simple program will not operate.
- If the program pattern is set to $STOP$, the RUN/STOP status will change to STOP after the soak time has expired. If the program pattern is set to $CONT$, control will continue in RUN status after the soak time has expired.



	Setting range	Default
\bar{OFF}	Simple program function turned OFF	\bar{OFF}
$STOP$	Go to STOP mode at end of program.	
$CONT$	Continue in RUN mode at end of program.	



- **Related Parameters**

Program Start (Operation Level): Page 6-11

Soak Time Remain (Operation Level): Page 6-12

RUN/STOP (Operation Level) : Page 6-12

Soak Time (Adjustment Level): Page 6-32

Wait Band (Adjustment Level): Page 6-32

Soak Time Unit (Advanced Function Setting Level): Page 6-83

[P
[-[P

Control Period (Heating)
Control Period (Cooling)

The heating and cooling control outputs must be assigned to relay or voltage outputs (for driving SSR).

The control must be set to 2-PID control.

For the Control Period (Cooling) parameter, the control must be set to heating/cooling control.



Function

- These parameters set the output periods. Set the control periods taking the control characteristics and the electrical life of the relay into consideration.
- For standard control, use the Control Period (Heating) parameter. The Control Period (Cooling) parameter cannot be used.
- When the heating control output is a current output, the Control Period (Heating) parameter cannot be used. Also, when the cooling control output is a current output, the Control Period (Cooling) parameter cannot be used.
- For heating/cooling control, the control period can be set independently for heating and cooling. The Control Period (Heating) parameter is used for the heating control output, and the Control Period (Cooling) parameter is used for the cooling control output.



Setting

Parameter name	Setting range	Unit	Default
Control Period (Heating)	0.1, 0.2, 0.5, 1 to 99	Seconds	20 for relay output
			2 for voltage output (for driving SSR)
Control Period (Cooling)	0.1, 0.2, 0.5, 1 to 99	Seconds	20 for relay output
			2 for voltage output (for driving SSR)



See

● Related Parameters

PID ON/OFF (Initial Setting Level): Page 6-43

REV Direct/Reverse Operation



Function

"Direct operation" refers to control where the manipulated variable is increased when the process value increases. Alternatively, "reverse operation" refers to control where the manipulated variable is increased when the process value decreases.



Setting

Setting range	Default
$\bar{a}R-R$: Reverse operation, $\bar{a}R-d$: Direct operation	$\bar{a}R-R$

AL1	Alarm 1 Type	Alarm 1 must be assigned.
AL2	Alarm 2 Type	Alarm 2 must be assigned.
AL3	Alarm 3 Type	Alarm 3 must be assigned.
AL4	Alarm 4 Type	Alarm 4 must be assigned.



Function

- Set the alarm type independently for each alarm in the Alarm 1 to 4 Type parameters in the Initial Setting Level.
- The alarms that can be set are listed in the following table.
- You can use an LBA (12) only for alarm 1.
- If the Controller is equipped with HB/HS alarm detection, the Alarm Type 1 is not displayed for the default settings. To use alarm 1, set an output assignment to alarm 1. (Refer to 4-6-3 Assigned Output Functions.)

Set value	Alarm type	Alarm output operation		Description of function
		When alarm value X is positive	When alarm value X is negative	
0	Alarm function OFF	Output OFF		No alarm
1	Upper- and lower-limit*1		*2	Set the upward deviation in the set point for the alarm upper limit (H) and the lower deviation in the set point for the alarm lower limit (L). The alarm is ON when the PV is outside this deviation range.
2 (default)	Upper-limit			Set the upward deviation in the set point by setting the alarm value (X). The alarm is ON when the PV is higher than the SP by the deviation or more.

Set value	Alarm type	Alarm output operation		Description of function
		When alarm value X is positive	When alarm value X is negative	
3	Lower-limit			Set the downward deviation in the set point by setting the alarm value (X). The alarm is ON when the PV is lower than the SP by the deviation or more.
4	Upper- and lower-limit range*1		*3	Set the upward deviation in the set point for the alarm upper limit (H) and the lower deviation in the set point for the alarm lower limit (L). The alarm is ON when the PV is inside this deviation range.
5	Upper- and lower-limit with standby sequence*1		*4	A standby sequence is added to the upper- and lower-limit alarm (1). *6
6	Upper-limit with standby sequence			A standby sequence is added to the upper-limit alarm (2). *6
7	Lower-limit with standby sequence			A standby sequence is added to the lower-limit alarm (3). *6
8	Absolute-value upper-limit			The alarm will turn ON if the process value is larger than the alarm value (X) regardless of the set point.
9	Absolute-value lower-limit			The alarm will turn ON if the process value is smaller than the alarm value (X) regardless of the set point.
10	Absolute-value upper-limit with standby sequence			A standby sequence is added to the absolute-value upper-limit alarm (8). *6
11	Absolute-value lower-limit with standby sequence			A standby sequence is added to the absolute-value lower-limit alarm (9). *6
12	LBA (alarm 1 type only)			*7
13	PV change rate alarm			*8
14	SP absolute-value upper-limit alarm			This alarm type turns ON the alarm when the set point (SP) is higher than the alarm value (X).
15	SP absolute-value lower-limit alarm			This alarm type turns ON the alarm when the set point (SP) is smaller than the alarm value (X).

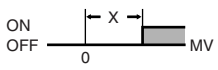
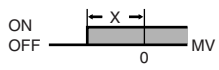
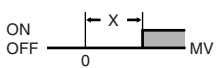
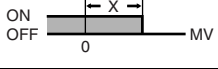
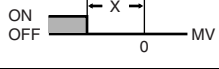
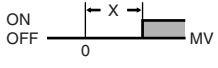
Set value	Alarm type	Alarm output operation		Description of function
		When alarm value X is positive	When alarm value X is negative	
16	MV absolute-value upper-limit alarm ^{*9}	Standard Control 	Standard Control 	This alarm type turns ON the alarm when the manipulated variable (MV) is higher than the alarm value (X).
		Heating/Cooling Control (Heating MV) 	Heating/Cooling Control (Heating MV) Always ON	
17	MV absolute-value lower-limit alarm ^{*9}	Standard Control 	Standard Control 	This alarm type turns ON the alarm when the manipulated variable (MV) is lower than the alarm value (X).
		Heating/Cooling Control (Cooling MV) 	Heating/Cooling Control (Cooling MV) Always ON	

*1 With set values 1, 4 and 5, the upper- and lower- limit values can be set independently for each alarm type, and are expressed as "L" and "H."

*2 Set value: 1 (Upper- and lower-limit alarm)

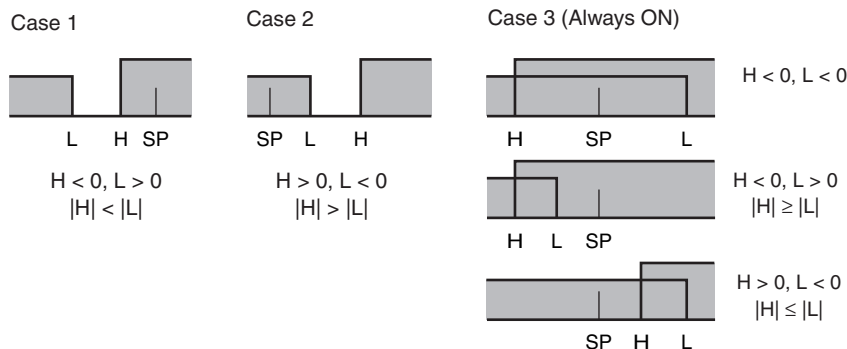

*3 Set value: 4 (Upper- and lower-limit range)

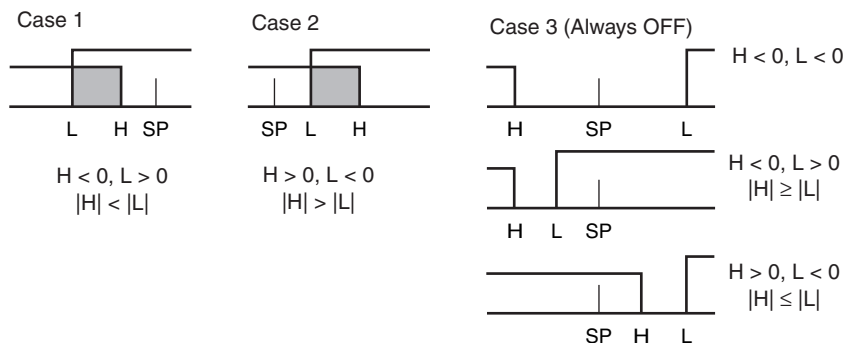

*4 Set value: 5 (Upper- and lower-limit alarm with standby sequence)

- For the upper- and lower-limit alarms in cases 1 and 2 above, the alarm is always OFF if upper- and lower-limit hysteresis overlaps.
- In case 3, the alarm is always OFF.

*5 Set value: 5 (Upper- and lower-limit alarm with standby sequence)

- The alarm is always OFF if upper- and lower-limit hysteresis overlaps.

*6 Refer to *Standby Sequence Reset* on page 6-65 for information on the operation of the standby sequence.

*7 Refer to *5-15-1 Loop Burnout Alarm (LBA)*.

*8 Refer to *PV Change Rate Alarm* on page 4-35.

- *9 When heating/cooling control is performed, the MV absolute-value upper-limit alarm functions only for the heating operation and the MV absolute-value lower-limit alarm functions only for the cooling operation.



● Related Parameters

Alarm Value 1 to 4 (Operation Level): Page 6-13

Alarm Value Upper Limit 1 to 4 and Alarm Value Lower Limit 1 to 4 (Operation Level):
Page 6-14

Alarm 1 to 4 Hysteresis (Initial Setting Level): Page 6-54

Standby Sequence Reset (Advanced Function Setting Level): Page 6-65

Auxiliary Output 1 to 4 Open in Alarm (Advanced Function Setting Level): Page 6-66

Alarm 1 to 4 Latch (Advanced Function Setting Level): Page 6-71

ALH1	Alarm 1 Hysteresis	Alarm 1 must be assigned. The alarm 1 type must not be 0, 12, or 13.
ALH2	Alarm 2 Hysteresis	Alarm 2 must be assigned. The alarm 2 type must not be 0, 12, or 13.
ALH3	Alarm 3 Hysteresis	Alarm 3 must be assigned. The alarm 3 type must not be 0, 12, or 13.
ALH4	Alarm 4 Hysteresis	Alarm 4 must be assigned. The alarm 4 type must not be 0, 12, or 13.



Function

- These parameters set the hysteresis for alarms 1, 2, 3, and 4.



Setting

Alarms Other Than an MV Alarm

	Setting range	Unit	Default
Temperature input	0.1 to 999.9	°C	0.2
		°F	0.4
Analog input	0.01 to 99.99	%FS	0.02

MV Alarms

Setting range	Unit	Unit
0.01 to 99.99	%	0.50



See

● Related Parameters

Alarm Value 1 to 4 (Operation Level): Page 6-13

Alarm Value Upper Limit 1 to 4 and Alarm Value Lower Limit 1 to 4 (Operation Level):
Page 6-14

Alarm 1 to 4 Type (Initial Setting Level): Page 6-50

Standby Sequence Reset (Advanced Function Setting Level): Page 6-65

Auxiliary Output 1 to 4 Open in Alarm (Advanced Function Setting Level): Page 6-66

Alarm 1 to 4 Latch (Advanced Function Setting Level): Page 6-71

015t**Control Output 1 Signal****Control output 1 must be a linear current output.**

Function

These parameters set the output signal for linear current outputs.

- Select 4 to 20 mA or 0 to 20 mA for the signal.



Setting

Setting range	Default
4-20: 4 to 20 mA	4-20
0-20: 0 to 20 mA	

0R5t**Transfer Output Signal 000****There must be a transfer output.**

Function

This parameter sets the output signal for the transfer output.

- Select 4 to 20 mA or 1 to 5 V.



Setting

Setting range	Default
4-20: 4 to 20 mA	4-20
1-5V: 1 to 5 V	

0R-t**Transfer Output Type 000****There must be a transfer output.**

Function

- This parameter sets the transfer output type.



Setting

Transfer output type	Default
OFF	0FF
Set point	SP
Set point during SP ramp	SP-M
PV	PV
MV (heating)	MV
MV (cooling) *1	E-MV

*1 This function can be set for standard control Model, but the setting will be disabled.



See

● Related Parameter

Transfer Output Upper Limit and Transfer Output Lower Limit (Initial Setting Level): Page 6-56

ER-H Transfer Output Upper Limit **000**

There must be a transfer output.

The transfer output type must not be set to OFF.

ER-L Transfer Output Lower Limit **000**



Function

- This parameter sets the upper and lower limit values of transfer outputs.



Setting

Transfer output type	Setting range		Default		Unit
			Transfer output lower limit	Transfer output upper limit	
Set point	SP lower limit to SP upper limit		SP lower limit	SP upper limit	EU
Set point during SP ramp	SP lower limit to SP upper limit				
PV	Temperature input	Input setting range lower limit to input setting range upper limit	Input setting range lower limit	Input setting range upper limit	
	Analog input	Analog scaling lower limit to analog scaling upper limit	Scaling lower limit	Scaling upper limit	
MV (heating)	Standard	-5.0 to 105.0	0.0	100.0	%
MV (cooling)	Heating/cooling	0.0 to 105.0			
Valve opening*1	Position-proportional control	-10.0 to 110.0			

*1 This function can be set for standard control Model, but the setting will be disabled.

● Related Parameter



Transfer Output Type (Initial Setting Level): Page 6-55

EV-1 Event Input Assignment 1

EV-2 Event Input Assignment 2

EV-3 Event Input Assignment 3

There must be event inputs.

EV-4 Event Input Assignment 4

EV-5 Event Input Assignment 5

EV-6 Event Input Assignment 6



Function

- The following functions can be assigned to event inputs 1 to 6.

RUN/STOP
 Auto/Manual Switch
 Program Start
 Invert Direct/Reverse Operation
 100% AT Execute/Cancel
 40% AT Execute/Cancel
 Setting Change Enable/Disable
 Communications Writing Enable/Disable
 Alarm Latch Cancel
 Multi-SP No. Switching Bit 0
 Multi-SP No. Switching Bit 1
 Multi-SP No. Switching Bit 2
 RUN/STOP
 PID Update (Adaptive Control)
 Automatic Filter Adjustment
 Water-cooling Output Adjustment

- Default: Event Input Assignment 1: *MSPD*
 Event Input Assignment 2: *SEOP*
 Event Input Assignment 3: *NONE*
 Event Input Assignment 4: *NONE*
 Event Input Assignment 5: *NONE*
 Event Input Assignment 6: *NONE*
- Do not assign the same function to more than one event input.



Setting	Function
<i>NONE</i>	None
<i>STOP</i>	RUN/STOP
<i>MANU</i>	Auto/Manual
<i>PRST</i>	Program Start* ¹
<i>DRS</i>	Invert Direct/Reverse Operation
<i>NONE</i>	None
<i>AT-2</i>	100% AT Execute/Cancel
<i>AT-1</i>	40% AT Execute/Cancel* ²
<i>WPE</i>	Setting Change Enable/Disable
<i>CMWE</i>	Communications Writing Enable/Disable* ³
<i>LAL</i>	Alarm Latch Cancel
<i>MSP0</i>	Multi-SP No. Switching Bit 0* ⁴
<i>MSP1</i>	Multi-SP No. Switching Bit 1* ⁴
<i>MSP2</i>	Multi-SP No. Switching Bit 2* ⁴
<i>RUN</i>	RUN/STOP
<i>R-UD</i>	PID Update (Adaptive Control)
<i>FR</i>	Automatic Filter Adjustment
<i>W-HE</i>	Water-cooling Output Adjustment

- *1 PRST (Program Start) can be set even when the Program Pattern parameter is set to OFF, but the function will be disabled.
- *2 This function can be set for heating/cooling control, but the function will be disabled.
- *3 This function can be set only for a Controller that supports communications. Also, when a work bit is selected as the event input data for a logic operation, Communications Write Enable/Disable cannot be assigned. If the Digital Controller is operating only on the power supply from the USB-Serial Conversion Cable, it will operate as if the event inputs remain OFF. Therefore, communications writing will be disabled and you will not be able to write data from Setup Tools, such as the CX-Thermo.
- *4 The following table shows the relationships between the ON/OFF status of multi-SP number switching bits 0 to 2 and the set point.

Selected set point	Multi-SP No. switching bits		
	Bit 0	Bit 1	Bit 2
SP 0	OFF	OFF	OFF
SP 1	ON	OFF	OFF
SP 2	OFF	ON	OFF
SP 3	ON	ON	OFF
SP 4	OFF	OFF	ON
SP 5	ON	OFF	ON
SP 6	OFF	ON	ON
SP 7	ON	ON	ON

Note: Any bits that are not assigned to event inputs are treated as being OFF.



● Related Parameter

SP 0 to 7 (Adjustment Level): Page 6-22

SQR**Extraction of Square Root Enable** An analog input must be supported.**MASK8**

Function

This parameter enables and disables square root extraction.



Setting

Setting range	Default
$\bar{o}N$: Enabled, $\bar{o}FF$: Disabled	OFF



See

- **Related Parameter**

Extraction of Square Root Low-cut Point (Adjustment Level): Page 6-35

P- $\bar{o}N$ **Operation After Power ON**

Function

This parameter sets the operating status when the power is turned ON.

You can set any of the following options.

- Continue (default): The status when power was interrupted is continued.
- Stop: Control will be stopped (stop).
- Manual: Manual Mode will be entered.

The specified operation is also used for software resets and when moving from initial setting level to operation level.



Setting

Parameter s	Setting range	Default
$\bar{C}oNt$	Continue	$\bar{C}oNt$
$\bar{S}tOP$	Stop	
$\bar{M}ANU$	Manual	



See

- **Related Parameters**

RUN/STOP (Operation Level): Page 6-12

PV/MV (Manual MV) (Manual Control Level): Page 6-39

bAR Bar Display Data**bARH** Bar Display Scaling Upper Limit**bARL** Bar Display Scaling Lower Limit

Function

- These parameters specify the data to use in the bar display.
- These parameters scale the values specified for the bar display data.



Setting

Parameter name	Setting range	Unit	Default
Bar Display Data	0FF: Nothing displayed.	---	MV ^{*1}
	MV: MV (heating)		
	E-MV: MV (cooling)		
	E-E-I: Heater current		
Bar Display Scaling Upper Limit	-199.9 to 999.9	<ul style="list-style-type: none"> • For MV (heating) or MV (cooling): % • For heater current 1: A 	100.0 ^{*2}
Bar Display Scaling Lower Limit			0.0

*1 The default value for the E5□D-□-8□□ is E-E-I.

*2 The default value for the E5□D-□-8□□ is 50.0.

There are ten bars in the display.



Operation Example:
If the scaling values are set for 0.0% to 100%, seven bars will be lit for a manipulated value of 70% (65.0% to 74.9%).



Precautions for Correct Use

If the heater current is displayed on the bar graph, the display will not be correct in the following cases.

- When the control period is 1 s or less
- When the ON time for control output is 100 ms or less

Example: If the control period is 2 s and the MV is 5%, the display will not be correct (2,000 ms × 0.05 = 100 ms).



Move to Advanced Function Setting Level

The Initial Setting/Communications Protect
parameter must be set to 0.



Function

- Set the Move to Advanced Function Setting Level parameter set value to "-169."
- Move to the advanced function setting level either by pressing Key or Key or by waiting or two seconds to elapse.



See

● Related Parameter

Initial Setting/Communication Protect (Protect Level): Page 6-4

6-8 Advanced Function Setting Level

The Advanced Function Setting Level is used for optimizing Digital Controller performance. To move to this level, input the password ("–169") from the Initial Setting Level.

To be able to enter the password, the Initial Setting/Communications Protect parameter in the Protect Level must be set to 0.

Moving to Advanced Function Setting Level

1 Move from the Operation Level to the Protect Level.

Refer to 6-2 Protect Level.

2 Display the Initial Setting/Communications Protect parameter.

Initial Setting/
Communications Protect
←
Set 0. Default: 1

3 Change the set value to 0.

4 Move from the Protect Level to the Operation Level to the Initial Setting Level.



5 Display the Move to Advanced Function Setting Level parameter.

Move to Advanced
Function Setting Level
←
Set –169. Default: 0

6 Change the set value to –169.

7 The Advanced Function Setting Level is displayed.

The display appears
as shown on the left.

- The parameters in the Advanced Function Setting Level can be used when the Initial Setting/Communications Protect parameter is set to 0.
- To switch between setting levels, press the  Key.
- To change set values, press the  and  Keys.

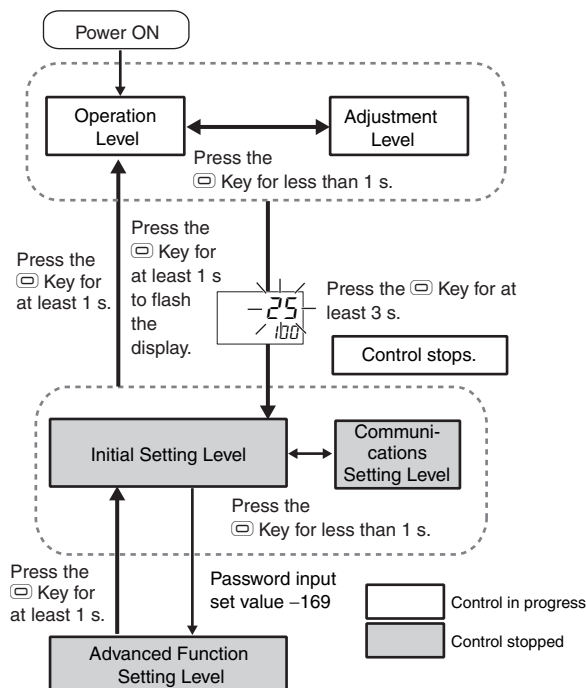

Advanced Function Setting Level												
		Page		Page		Page		Page		Page		Page
CNLT OFF	Parameter Initialization	6-64	R2LT OFF	Alarm 2 Latch	6-71	LbAL 8.0	LBA Level	6-78	PFd5 0	Monitor/Setting Item 5 MASK8	6-87	
↓			↓			↓			↓			
MSPU OFF	Number of Multi-SP Points	6-64	R3LT OFF	Alarm 3 Latch	6-71	LbAb 3.0	LBA Band	6-79	SPd1 4	PV/SP No. 1 Display Selection ²	6-88	
↓			↓			↓			↓			
SPRU H	SP Ramp Time Unit	6-64	R4LT OFF	Alarm 4 Latch	6-71	OUT1 0	Control Output 1 Assignment	6-80	SPd2 0	PV/SP No. 2 Display Selection	6-88	
↓			↓			↓			↓			
RESL R	Standby Sequence Reset	6-65	PRLT 3	Move to Protect Level Time	6-72	OUT2 HdNE	Control Output 2 Assignment	6-80	PVSt OFF	PV Status Display Function	6-89	
↓			↓			↓			↓			
SbIN H-o	Auxiliary Output 1 Open in Alarm	6-66	CJCL dM	Cold Junction Compensation Method	6-72	SUB1 RLM1	Auxiliary Output 1 Assignment	6-81	SVSt OFF	SV Status Display Function	6-90	
↓			↓			↓			↓			
Sb2N H-o	Auxiliary Output 2 Open in Alarm	6-66	AlON 0	Alarm 1 ON Delay	6-73	SUB2 RLM2	Auxiliary Output 2 Assignment	6-81	dREF 0.25	Display Refresh Period	6-90	
↓			↓			↓			↓			
Sb3N H-o	Auxiliary Output 3 Open in Alarm	6-66	R2ON 0	Alarm 2 ON Delay	6-73	SUB3 RLM3	Auxiliary Output 3 Assignment	6-81	LCTML 0.2	LCT Cooling Output Minimum ON Time	6-91	
↓			↓			↓			↓			
Sb4N H-o	Auxiliary Output 4 Open in Alarm	6-66	R3ON 0	Alarm 3 ON Delay	6-73	SUB4 RLM4	Auxiliary Output 4 Assignment	6-81	A-dV 50.0	Adaptive Control Operation Possible Deviation	6-91	
↓			↓			↓			↓			
HbU dH	HB ON/OFF	6-66	R4ON 0	Alarm 4 ON Delay	6-73	ALMA 49	Integrated Alarm Assignment	6-82	A-Sd 15.0	System Fluctuation Reference Deviation	6-92	
↓			↓			↓			↓			
HbL OFF	Heater Burnout Latch	6-67	AlOFF 0	Alarm 1 OFF Delay	6-74	t-U M	Soak Time Unit	6-83	FRSP 2.0	Automatic Filter Adjustment Seal Period	6-92	
↓			↓			↓			↓			
HbH 0.1	Heater Burnout Hysteresis	6-67	R2OFF 0	Alarm 2 OFF Delay	6-74	ALSP SP-M	Alarm SP Selection MASK8	6-83	FRHP 20.0	Automatic Filter Adjustment Hunting Monitor Period	6-92	
↓			↓			↓			↓			
ALFA 0.65	α	6-68	R3OFF 0	Alarm 3 OFF Delay	6-74	MANL OFF	Manual MV Limit Enable MASK8	6-84	W-LC 1.70	Water-cooling Proportional Band Increase Constant	6-93	
↓			↓			↓			↓			
LCdU I	Integral/Derivative Time Unit	6-68	R4OFF 0	Alarm 4 OFF Delay	6-74	PVRC 20	PV Rate of Change Calculation Period	6-84	W-dC 0.90	Water-cooling Proportional Band Decrease Constant	6-94	
↓			↓			↓			↓			
AL-G 0.0	AT Calculated Gain MASK8	6-69	MANH HdL	Manual Output Method	6-74	HCLM 0	Heating/Cooling Tuning Method	6-85	PWEM 0	Power ON Time Monitor	6-94	
↓			↓			↓			↓			
AL-H 0.0	AT Hysteresis MASK8	6-69	MANL 0.0	Manual MV Initial Value	6-75	AMPW 1.0	Minimum Output ON/OFF Band	6-85	AbEM 25	Ambient Temperature Monitor	6-94	
↓			↓			↓			↓			
LCMA 20.0	Limit Cycle MV Amplitude MASK8	6-69	RT OFF	RT MASK8	6-76	PF SHFt	PF Setting	6-86	RAIM 0	Control Output 1 ON/OFF Count Monitor	6-95	
↓			↓			↓			↓			
MAV OFF	Moving Average Count ¹	6-70	HSU dH	HS Alarm Use	6-76	PFd1 0	Monitor/Setting Item 1 MASK8	6-87	RA2M 0	Control Output 2 ON/OFF Count Monitor	6-95	
↓			↓			↓			↓			
REt OFF	Automatic Display Return Time	6-70	HSL OFF	HS Alarm Latch	6-77	PFd2 0	Monitor/Setting Item 2 MASK8	6-87	RAC 0	ON/OFF Counter Reset	6-95	
↓			↓			↓			↓			
bRGt 3	Display Brightness MASK8	6-70	HSH 0.1	HS Alarm Hysteresis	6-77	PFd3 0	Monitor/Setting Item 3 MASK8	6-87	PMSt OFF	Parameter Mask Setting	6-95	
↓			↓			↓			↓			
ALtL OFF	Alarm 1 Latch	6-71	LbA 0	LBA Detection Time	6-78	PFd4 0	Monitor/Setting Item 4 MASK8	6-87	CMoV 0	Move to Calibration Level MASK8	6-96	

*1 The default value for the E5□D-□-8□□ is 8.

*2 The default value for the E5□D-□-8□□ is 1.

INLT Parameter Initialization



- This parameter returns all parameter settings to their defaults.
- After the initialization, the set value automatically turns OFF.



Setting range	Default
<i>OFF</i> : Initialization is not executed.	<i>OFF</i>
<i>FACT</i> : Initializes to the factory settings described in the manual.	

MSPU Number of Multi-SP Points

The Digital Controller must not have event inputs or the Event Input Assignment 1 to Event Input Assignment 4 parameters must not be set to “Multi-SP No. switching bit 0” to “Multi-SP No. switching bit 2.”



This parameter sets the number of Multi-SP points that will be used with key operations (none or 2 to 8).



Setting range	Default
OFF, 2 to 8	OFF

SPRU SP Ramp Time Unit



- This parameter sets the time unit for the rate of change during SP ramp operation.



Setting range	Default
<i>S</i> : EU/s, <i>M</i> : EU/min, <i>H</i> : EU/h	<i>M</i>



● Related Parameters

Ramp SP Monitor (Operation Level): 6-9

SP Ramp Set Value and SP Ramp Fall Value (Adjustment Level): Page 6-34

RESET**Standby Sequence Reset****Alarm 1 to 4 type must be 5, 6, 7, 10, or 11.**

Function

- This parameter selects the conditions for enabling reset after the standby sequence of the alarm has been canceled.
- Output is turned OFF when switching to the Initial Setting Level, Communications Setting Level, Advanced Function Setting Level, or Calibration Level.
- Condition A
Control started (including when the power supply is turned ON), and an alarm value (alarm value upper/lower limit), the process value input shift, the process value slope coefficient, or the SP changed.
- Condition B
Power ON
- The following example shows the reset action when the alarm type is lower-limit alarm with standby sequence.

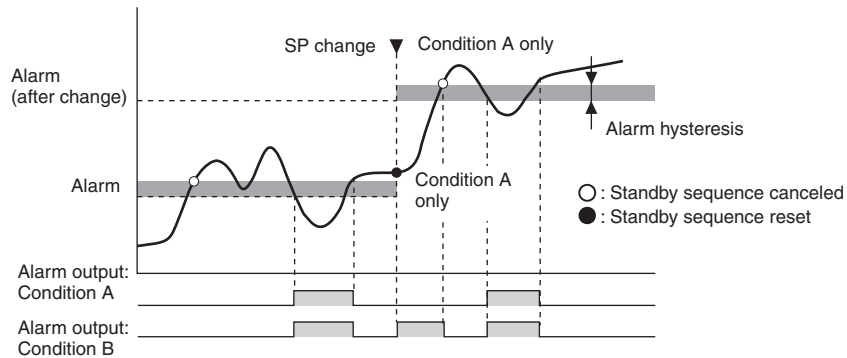

Setting

Setting range	Default
\bar{R} : Condition A, b : Condition B	\bar{R}



See

- **Related Parameters**

Alarm 1 to 4 Type (Initial Setting Level): Page 6-50

Alarm 1 to 4 Latch (Advanced Function Setting Level): Page 6-71

<i>Sb1N</i>	Auxiliary Output 1 Open in Alarm	Auxiliary output 1 must be assigned.
<i>Sb2N</i>	Auxiliary Output 2 Open in Alarm	Auxiliary output 2 must be assigned.
<i>Sb3N</i>	Auxiliary Output 3 Open in Alarm	Auxiliary output 3 must be assigned.
<i>Sb4N</i>	Auxiliary Output 4 Open in Alarm	Auxiliary output 4 must be assigned.



- This parameter sets the output status of auxiliary outputs 1 to 4.
- When Close in Alarm is set, the status of the auxiliary output function is output unchanged. When Open in Alarm is set, the status of the auxiliary output function is reversed before being output. The following table shows the relationship between the auxiliary output function, auxiliary output, and operation displays (SUB1 to SUB4).



	Auxiliary output function	Auxiliary output	Operation display (SUB1 to SUB4)
Close in Alarm	ON	ON	Lit
	OFF	OFF	Not lit
Open in Alarm	ON	OFF	Lit
	OFF	ON	Not lit

Setting range	Default
$N-\bar{a}$: Close in alarm, $N-\bar{L}$: Open in alarm	$N-\bar{a}$



● Related Parameters

Auxiliary Output 1 to 4 Assignment (Advanced Function Setting Level): Page 6-81

HbU **HB ON/OFF**

**HB and HS alarms must be supported.
A Control Output Assignment or Auxiliary Output Assignment must be set to a heater alarm or heater burnout alarm.**



- Set to use the heater burnout alarm.
- This parameter is displayed when a Control Output Assignment or an Auxiliary Output Assignment is set to a heater alarm or heater burnout alarm.



Setting range	Default
$\bar{a}N$: Enabled, $\bar{a}FF$: Disabled	$\bar{a}N$



● Related Parameters

Control Output 1 and 2 Assignment (Advanced Function Setting Level): Page 6-80

Auxiliary Output 1 to 4 Assignment (Advanced Function Setting Level): Page 6-80

HbL**Heater Burnout Latch**

**HB and HS alarms must be supported.
The HB ON/OFF parameter must be set to ON.**



Function

- When this parameter is set to ON, the heater burnout alarm is held until either of the following conditions is satisfied.
 - a Heater burnout detection is set to 0.0 A.
 - b The power is cycled.
 - c The latch is cancelled by the PF Key.
(PF Setting = LAT: Alarm Latch Cancel)
 - d The latch is cancelled by an event input.
(Event Input Assignment 1 to Event Input Assignment 6 = LAT: Alarm Latch Cancel)
- Output is turned OFF when switching to the Initial Setting Level.



Setting

Setting range	Default
$\bar{o}N$: Enabled, $\bar{o}FF$: Disabled	$\bar{o}FF$



See

● Related Parameters

- Heater Burnout Detection 1 (Adjustment Level): Page 6-20
- Event Input Assignment 1 to 4 (Initial Setting Level): Page 6-57
- HB ON/OFF (Advanced Function Setting Level): Page 6-66
- PF Setting (Advanced Function Setting Level): Page 6-86

HbH**Heater Burnout Hysteresis**

**HB and HS alarms must be supported.
The HB ON/OFF parameter must be set to ON. The
Heater Burnout Latch parameter must be set to
OFF.**



Function

- This parameter sets hysteresis for heater burnout detection.



Setting

Setting range	Unit	Default
0.1 to 50.0	A	0.1



See

● Related Parameters

- HB ON/OFF (Advanced Function Setting Level): Page 6-66

ALFA α

Control must be set to 2-PID control. Either the Standard or Heating/Cooling parameter must be set to heating/cooling control or, if the Standard or Heating/Cooling parameter is set to standard control, adaptive control must be disabled.



Function

- Normally, use the default for this parameter.
- This parameter sets the 2-PID control a constant.



Setting

Setting range	Default
0.00 to 1.00	0.65



See

● Related Parameters

PID ON/OFF (Initial Setting Level): Page 6-43

ELDU**Integral/Derivative Time Unit****Control must be set to 2-PID control.**

Function

This parameter sets the time unit for the Integral Time, Integral Time (Cooling), Derivative Time, and Derivative Time (Cooling) parameters.



Setting

Setting range	Unit	Default
1 to 0.1	Seconds	1

Note: The Integral/Derivative Time Unit parameter changes to 0.1 when the RT (robust tuning) parameter is changed from OFF to ON.



See

● Related Parameters

Integral Time and Derivative Time (Adjustment Level): Page 6-26

Derivative Time (Cooling) and Integral Time (Cooling) (Adjustment Level): Page 6-27

AT-G AT Calculated Gain **MASK8**

Control must be set to 2-PID control.

AT-H AT Hysteresis **MASK8**

LCMA Limit Cycle MV Amplitude **MASK8**

The control must be standard control and 2-PID control.



Function

- Normally use the default values for these parameters.
- The AT Calculated Gain parameter sets the gain for when PID constants are calculated using AT. When emphasizing response, decrease the set value. When emphasizing stability, increase the set value.
- The AT Hysteresis parameter sets the hysteresis for limit cycle operation during autotuning when switching ON and OFF.
- The Limit Cycle MV Amplitude parameter sets the MV amplitude for limit cycle operation during autotuning.



Setting

Parameter name	Setting range	Unit	Default
AT Calculated Gain	0.1 to 10.0	---	0.8
AT Hysteresis	Temperature input: 0.1 to 999.9	°C	0.8
	Analog input: 0.01 to 9.99	°F	1.4
Limit Cycle MV Amplitude	5.0 to 50.0	%	20.0



See

● Related Parameters

AT Execute/Cancel (Adjustment Level): Page 6-18

MAV Moving Average Count

- This parameter sets the number of inputs to include in the moving average. The data after moving average processing is illustrated in the following figure.

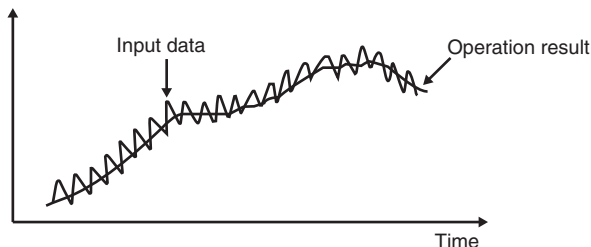

- Use a moving average to suppress rapid changes in the input.



Setting range	Unit	Default
OFF, 2, 4, 8, 16, or 32	Times	OFF*

* The default is 8 for models other than the E5□D-□-8□□.

RET Automatic Display Return Time

- In the Operation Level, Adjustment Level, or Monitor/Setting Item Level, the display automatically returns to the PV/SP if there are no key operations for the time set for this parameter.
- The automatic display return time is disabled when the parameter is set to OFF. (In that case, the display will not be automatically switched.)



Setting range	Unit	Default
OFF, 1 to 99	Seconds	OFF

BRGT Display Brightness

MASK8



This parameter sets the display brightness to one of three levels. Adjust the level if the display is too bright.



Setting range	Default
1 (dark) to 3 (bright)	3

A1LE	Alarm 1 Latch	Alarm 1 must be assigned, and the alarm 1 type must not be 0.
A2LE	Alarm 2 Latch	Alarm 2 must be assigned, and the alarm 2 type must not be 0 or 12.
A3LE	Alarm 3 Latch	Alarm 3 must be assigned, and the alarm 3 type must not be 0 or 12.
A4LE	Alarm 4 Latch	Alarm 4 must be assigned, and the alarm 4 type must not be 0 or 12.



Function

- When this parameter is set to ON, the alarm function is held until one of the following conditions is satisfied.
 - The power is cycled.
 - The latch is cancelled by the PF Key. (PF Setting = LAT: Alarm Latch Cancel)
 - The latch is cancelled by an event input. (Event Input Assignment 1 to Event Input Assignment 4 = LAT: Alarm Latch Cancel)
- The output is turned OFF when switching to the Initial Setting Level, Communications Setting Level, Advanced Function Setting Level, or Calibration Level.
- If an auxiliary output is set to close in alarm, the output is kept closed. If it is set to open in alarm, it is kept open.
- If an alarm OFF delay is set, the alarm latch will not be canceled immediately even if condition b or c is met. It will be canceled after the time set for the OFF delay has expired.



Setting

Setting range	Default
$\bar{a}N$: Enabled, $\bar{a}FF$: Disabled	$\bar{a}FF$



See

● Related Parameters

- Alarm Value 1 to 4 (Operation Level): Page 6-13
- Alarm Value Upper Limit 1 to 4 and Alarm Value Lower Limit 1 to 4 (Operation Level): Page 6-14
- Alarm 1 to 4 Type (Initial Setting Level): Page 6-50
- Standby Sequence Reset (Advanced Function Setting Level): Page 6-65
- Event Input Assignment 1 to 4 (Initial Setting Level): Page 6-57
- Auxiliary Output 1 to 4 Open in Alarm (Initial Setting Level): Page 6-66
- Alarm 1 to 4 Hysteresis (Initial Setting Level): Page 6-54
- HB ON/OFF (Advanced Function Setting Level): Page 6-66
- PF Setting (Advanced Function Setting Level): Page 6-86

PRLt Move to Protect Level Time

- This parameter sets the key pressing time required to move to the Protect Level from the Operation Level, the Adjustment Level, or Monitor/Setting Item Level.



Setting range	Unit	Default
1 to 30	Seconds	3

CJC**Cold Junction Compensation Method****Input type must be thermocouple or infrared temperature sensor**

- This parameter specifies whether cold junction compensation is to be performed internally by the Digital Controller or to be performed externally when the input type setting is 5 to 24.
- The cold junction compensation external setting is enabled when the temperature difference is measured using two thermocouples or two ES1B Sensors.



Setting range	Default
$\bar{a}N$: Internally, $\bar{a}FF$: Externally	$\bar{a}N$

● **Related Parameters**

Input Type (Initial Setting Level): Page 6-41

R1$\bar{O}N$	Alarm 1 ON Delay	Alarm 1 must be assigned, and the alarm 1 type must not be 0, 12, or 13.
R2$\bar{O}N$	Alarm 2 ON Delay	Alarm 2 must be assigned, and the alarm 2 type must not be 0, 12, or 13.
R3$\bar{O}N$	Alarm 3 ON Delay	Alarm 3 must be assigned, and the alarm 3 type must not be 0, 12, or 13.
R4$\bar{O}N$	Alarm 4 ON Delay	Alarm 4 must be assigned, and the alarm 4 type must not be 0, 12, or 13.

The alarm 1, 2, 3, or 4 output is prevented from turning ON until after the delay times set in these parameters have elapsed.



Function

- Set the time for which the ON delay is to be enabled.
- To disable the ON delay, set 0.



Setting

Setting range	Unit	Default
0 to 999	Seconds	0



See

● Related Parameters

Alarm 1 to 4 Type (Initial Setting Level): Page 6-50

<i>A1ōF</i>	Alarm 1 OFF Delay	Alarm 1 must be assigned, and the alarm 1 type must not be 0, 12, or 13.
<i>A2ōF</i>	Alarm 2 OFF Delay	Alarm 2 must be assigned, and the alarm 2 type must not be 0, 12, or 13.
<i>A3ōF</i>	Alarm 3 OFF Delay	Alarm 3 must be assigned, and the alarm 3 type must not be 0, 12, or 13.
<i>A4ōF</i>	Alarm 4 OFF Delay	Alarm 4 must be assigned, and the alarm 4 type must not be 0, 12, or 13.

The alarm 1, 2, 3, or 4 output is prevented from turning OFF until after the delay times set in these parameters have elapsed.



- Set the time for which the OFF delay is to be enabled.
- To disable the OFF delay, set 0.



Setting range	Unit	Default
0 to 999	Seconds	0



● Related Parameters

Alarm 1 to 4 Type (Initial Setting Level): Page 6-50

<i>MANE</i>	Manual Output Method	The control must be set to 2-PID control.
--------------------	----------------------	---



If this parameter is set to HOLD when control moves from Automatic Mode to Manual Mode, the final MV from Automatic Mode will be used as the initial manual MV. If this parameter is set to INT, the setting of the Manual MV Initial Value parameter will be used as the initial manual MV.



Setting range	Default
<i>HōLd</i> : HOLD, <i>ĪNĪt</i> : INIT	<i>HōLd</i>



● Related Parameters

Manual MV Initial Value (Advanced Function Setting Level): 6-75

MANV**Manual MV Initial Value****The control must be set to 2-PID control.**

Function

This parameter sets the initial value of the manual MV to use after control moves from Automatic Mode to Manual Mode.



Setting

Setting range	Unit	Default
Standard control: -5.0 to 105.0	%	0.0
Heating/cooling control: -105.0 to 105.0		

If the Manual MV Limit Enable parameter is set to ON, the setting range will be the MV lower limit to the MV upper limit.



See

- **Related Parameters**

Manual Output Method (Advanced Function Setting Level): Page 6-74

Manual MV Limit Enable (Advanced Function Setting Level): Page 6-84

RT RT

The control must be set to 2-PID control.
The input type must be set for a temperature input.
The Adaptive Control parameter must be set to “Disabled.”

Either the Standard or Heating/Cooling parameter must be set to standard control or, if the Standard or Heating/Cooling parameter is set to heating/cooling control, the Heating/Cooling Tuning Method parameter must not be set to air or water cooling.

MASK8

This parameter executes robust tuning (RT).



- When AT is executed with RT selected, PID constants are automatically set that make it hard for control performance to deteriorate even when the characteristics of the controlled object are changed.
- Even when hunting occurs for PID constants when AT is executed in normal mode, it is less likely to occur when AT is executed in RT Mode.



Setting range	Default
$\bar{a}N$: RT function ON, $\bar{a}FF$: RT function OFF	$\bar{a}FF$

Note: The Integral/Derivative Time Unit parameter changes to 0.1 when the RT (Robust Tuning) parameter is changed from OFF to ON.



● Related Parameters

- AT Execute/Cancel (Adjustment Level): Page 6-18
- Proportional Band, Integral Time, and Derivative Time (Adjustment Level): Page 6-26
- Proportional Band (Cooling), Derivative Time (Cooling), and Integral Time (Cooling) (Adjustment Level): Page 6-27
- PID ON/OFF (Initial Setting Level): Page 6-43
- Integral/Derivative Time Unit (Advanced Function Setting Level): Page 6-68

HSU HS Alarm Use

HB and HS alarms must be supported.
A Control Output Assignment or Auxiliary Output Assignment must be set to a heater alarm or HS alarm.



- Set this parameter to use HS alarms.
- This parameter is displayed when a Control Output Assignment or Auxiliary Output Assignment is set to a heater alarm or HS alarm.



Setting range	Default
$\bar{a}N$: Enabled, $\bar{a}FF$: Disabled	$\bar{a}N$



● Related Parameters

- Control Output 1 and 2 Assignment (Advanced Function Setting Level): Page 6-80
- Auxiliary Output 1 to 4 Assignment (Advanced Function Setting Level): Page 6-81

H5L**HS Alarm Latch**

**HB and HS alarms must be supported.
The HS Alarm Use parameter must be set to ON.**



Function

- When this parameter is set to ON, the HS alarm is held until any of the following conditions is satisfied.
 - a The HS alarm current is set to 50.0 A.
 - b The power is cycled.
 - c The latch is cancelled by the PF Key.
(PF Setting = LAT: Alarm Latch Cancel)
 - d The latch is cancelled by an event input.
(Event Input Assignment 1 to Event Input Assignment 4 = LAT: Alarm Latch Cancel)
- Output is turned OFF when switching to the Initial Setting Level, Communications Setting Level, Advanced Function Setting Level, or Calibration Level.



Setting

Setting range	Default
$\bar{a}N$: Enabled, $\bar{a}FF$: Disabled	$\bar{a}FF$



See

- **Related Parameters**

- HS Alarm Use (Advanced Function Setting Level): Page 6-76
- Event Input Assignment 1 to 4 (Initial Setting Level): Page 6-57
- HB ON/OFF (Advanced Function Setting Level): Page 6-66
- PF Setting (Advanced Function Setting Level): Page 6-86

H5H**HS Alarm Hysteresis**

**HB and HS alarms must be supported.
The HS Alarm Use parameter must be set to ON.
The HS Alarm Latch parameter must be set to OFF.**



Function

- This parameter sets the hysteresis for HS alarms.



Setting

Setting range	Unit	Default
0.1 to 50.0	A	0.1



See

- **Related Parameters**

- HS Alarm Use (Advanced Function Setting Level): Page 6-76

LbA**LBA Detection Time**

**Alarm 1 must be assigned.
The alarm type must be set to 12 (LBA).**

This parameter enables or disables the LBA function and sets the detection time interval.



Function

- To disable the LBA function, set 0.



Setting

Setting range	Unit	Default
0 to 9999	Seconds	0



● Related Parameters

Alarm 1 to 4 Type (Initial Setting Level): Page 6-50

LBA Level (Advanced Function Setting Level): Page 6-78

LBA Band (Advanced Function Setting Level): Page 6-79

LbAL**LBA Level**

**Alarm 1 must be assigned.
The alarm type must be set to 12 (LBA).
The LBA detection time must not be 0.**



Function

- This parameter sets the LBA level.
- If the deviation between the SP and PV exceeds the LBA level, a loop burnout is detected.



Setting

Setting range		Unit	Default
Temperature input	0.1 to 999.9	°C	8.0
		°F	14.4
Analog input	0.01 to 99.99	%FS	10.00



● Related Parameters

Process Value/Set Point (Operation Level): Page 6-8

Alarm 1 to 4 Type (Initial Setting Level): Page 6-50

LBA Detection Time (Advanced Function Setting Level): Page 6-78

LBA Band (Advanced Function Setting Level): Page 6-79

LbAb LBA Band

Alarm 1 must be assigned.
The alarm type must be set to 12 (LBA).
The LBA detection time must not be 0.



- This parameter sets the LBA band.
- If a control deviation greater than the LBA band is not reduced when the LBA level is exceeded, an loop burnout is detected.



Setting range		Unit	Default
Temperature input	0.0 to 999.9	°C	3.0
		°F	5.4
Analog input	0.00 to 99.99	%FS	0.20



● **Related Parameters**

Process Value/Set Point (Operation Level): Page 6-8

Alarm 1 to 4 Type (Initial Setting Level): Page 6-50

LBA Detection Time (Advanced Function Setting Level): Page 6-78

LBA Level (Advanced Function Setting Level): Page 6-78

OUT1 Control Output 1 Assignment

OUT2 Control Output 2 Assignment

A Standard Model with two control outputs must be used.



Function



Setting

- These parameters set the function to assign to control outputs 1 and 2.

Setting range		Default
NONE:	Disabled	Control Output 1 Assignment: \bar{a}
\bar{a} :	Control output (heating)	Control Output 2 Assignment: NONE*4
\bar{c} :	Control output (cooling)*1	
ALM1:	Alarm 1*5	
ALM2:	Alarm 2*5	
ALM3:	Alarm 3*5	
ALM4:	Alarm 4*5	
HA:	Heater alarm*5	
Hb:	HB alarm*5	
HS:	HS alarm*5	
S.ERR:	Input error*5	
NONE:	Disabled*5	
P.END:	Program end output*2*5	
RUN:	RUN output*5	
ALM:	Integrated Alarm*5	
WR1:	Work bit 1*3*5	
WR2:	Work bit 2*3*5	
WR3:	Work bit 3*3*5	
WR4:	Work bit 4*3*5	
WR5:	Work bit 5*3*5	
WR6:	Work bit 6*3*5	
WR7:	Work bit 7*3*5	
WR8:	Work bit 8*3*5	

- *1 If \bar{c} is assigned for standard control, a value equivalent to 0% is output.
- *2 Can be selected when the Program Pattern parameter is set to OFF, but the function will be disabled.
- *3 WR1 to WR8 are not displayed when the logic operation function is not used.
- *4 If the Standard or Heating/Cooling parameter is set to heating/cooling control, control automatically switches to \bar{c} .
- *5 Can be selected for relay and voltage outputs (for driving SSR) only.

Sub 1	Auxiliary Output 1 Assignment	There must be an auxiliary output 1.
Sub 2	Auxiliary Output 2 Assignment	There must be an auxiliary output 2.
Sub 3	Auxiliary Output 3 Assignment	There must be an auxiliary output 3.
Sub 4	Auxiliary Output 4 Assignment	There must be an auxiliary output 4.

- These parameters set the function to assign to auxiliary outputs 1 to 4.

Setting range		Default
\overline{NONE} :	Disabled	Auxiliary Output 1 Assignment: $RLM1^{*5}$
\bar{a} :	Control output (heating)	Auxiliary Output 2 Assignment: $RLM2^{*2}$
$\overline{C-\bar{a}}$:	Control output (cooling) ^{*1}	Auxiliary Output 3 Assignment: $RLM3$
$RLM1$:	Alarm 1	Auxiliary Output 4 Assignment: $RLM4^{*2}$
$RLM2$:	Alarm 2	
$RLM3$:	Alarm 3	
$RLM4$:	Alarm 4	
HR :	Heater alarm	
Hb :	HB alarm	
HS :	HS alarm	
$S.ERR$:	Input error	
\overline{NONE} :	Disabled	
$P.END$:	Program end output ^{*3}	
RUN :	RUN output	
RLM :	Integrated Alarm	
$WR1$:	Work bit 1 ^{*4}	
$WR2$:	Work bit 2 ^{*4}	
$WR3$:	Work bit 3 ^{*4}	
$WR4$:	Work bit 4 ^{*4}	
$WR5$:	Work bit 5 ^{*4}	
$WR6$:	Work bit 6 ^{*4}	
$WR7$:	Work bit 7 ^{*4}	
$WR8$:	Work bit 8 ^{*4}	

- *1 If $\overline{C-\bar{a}}$ is assigned for standard control, a value equivalent to 0% will be output.
- *2
- When heating/cooling control is selected for the E5CD or E5CD-B, auxiliary output 2 is assigned as the control output for cooling.
 - If heating/cooling control is selected for the E5ED or E5ED-B when there is only one control output, the auxiliary output 4 terminal is assigned as the control output for cooling. (However, if the Digital Controller has two auxiliary outputs, auxiliary output 2 is the cooling control output.)
- *3 Can be selected when the Program Pattern parameter is set to OFF, but the function will be disabled.
- *4 WR1 to WR8 are not displayed when the logic operation function is not used.
- *5 If the Digital Controller is equipped with HB/HS alarm detection, it is set by default to HR (Heater Alarm).

ALMA**Integrated Alarm Assignment****The integrated alarm must be assigned.**

Function

You can use the integrated alarm to output an OR of alarm 1, alarm 2, alarm 3, alarm 4, the HB alarm, the HS alarm, and the input alarm. Set this parameter to the sum of the codes of the status for which to output an OR.

The default is 49 (i.e., an OR of alarm 1, the HB alarm, and the HS alarm is output). The alarm 1 code is 1, the HB alarm code is 16, and the HS alarm code is 32: $1 + 16 + 32 = 49$.



Setting

Code	Status
+1	Alarm 1
+2	Alarm 2
+4	Alarm 3
+8	Alarm 4
+16	HB alarm
+32	HS alarm
+64	Input error
+128	(Spare)

Setting range	Default
0 to 255	49



- **Related Parameters**

Alarm Value 1 to 4 (Operation Level): Page 6-13

MV at Error (Adjustment Level): Page 6-33

HB ON/OFF (Advanced Function Setting Level): Page 6-66

HS Alarm Use (Advanced Function Setting Level): Page 6-76

t-U**Soak Time Unit**

The Program Pattern parameter must not be set to OFF.



Function

Set the soak time unit for the simple program function.



Setting

Setting range	Default
s: Seconds, m: Minutes, h: Hours	M



See

● Related Parameters

- Program Start (Operation Level): Page 6-11
- Soak Time Remain (Operation Level): Page 6-12
- Soak Time (Adjustment Level): Page 6-32
- Wait Band (Adjustment Level): Page 6-32
- Program Pattern (Initial Setting Level): Page 6-48

ALSP**Alarm SP Selection**

Alarm 1 to alarm 4 must be assigned.
 The SP Ramp Set Value parameter must not be set to OFF and the SP Ramp Fall Value parameter must not be set to SAME or OFF.
 The alarm type must be set to 1, 2, 3, 4, 5, 6, 7, 14, or 15.

MASK8

This parameter sets whether the set point that triggers the alarm is the ramp SP or target SP.



Setting

Setting range	Default
SP-M: Ramp SP, SP: SP	SP-M



See

● Related Parameters

- SP Ramp Set Value and SP Ramp Fall Value (Adjustment Level): Page 6-34

MANL**Manual MV Limit Enable**

The control must be set to 2-PID control.

MASK8

Function

This parameter sets whether the MV Upper Limit and MV Lower Limit parameters are to be enabled for manual MV in Manual Mode.



Setting

Setting range	Default
$\bar{a}N$: Enabled, $\bar{a}FF$: Disabled	$\bar{a}FF$



See

- **Related Parameters**

MV Upper Limit (Adjustment Level): Page 6-34

MV Lower Limit (Adjustment Level): Page 6-34

PV RP**PV Rate of Change Calculation Period**

Alarms 1, 2, 3, and 4 must be assigned. The alarm type must be set to 13.



Function

- The change width can be found for PV input values in any set period. Differences with previous values in each set period are calculated, and an alarm is output if the results exceed the alarm value.
- The PV rate of change calculation period can be set in units of 50 ms (sampling period).



Setting

Setting range	Unit	Default
1 to 999	Sampling periods	20 (1 s)



See

- **Related Parameters**

Process Value/Set Point (Operation Level): Page 6-8

Alarm 1 to 4 Type (Initial Setting Level): Page 6-50

HCEM**Heating/Cooling Tuning Method**

The control must be set to heating/cooling control and 2-PID control.



Function

This parameter sets the tuning method that is suitable for the cooling control characteristics.



Setting

Setting range	Default
0: Same as heating control	0
1: Linear	
2: Air cooling	
3: Water cooling	

- Air Cooling/Water Cooling
Control that is suitable for an application that does not have linear cooling characteristics (such as plastic molding machines) is performed. The response is fast and the response characteristics are stable.
- Linear
Control that is suitable for an application that has linear cooling characteristics is performed.

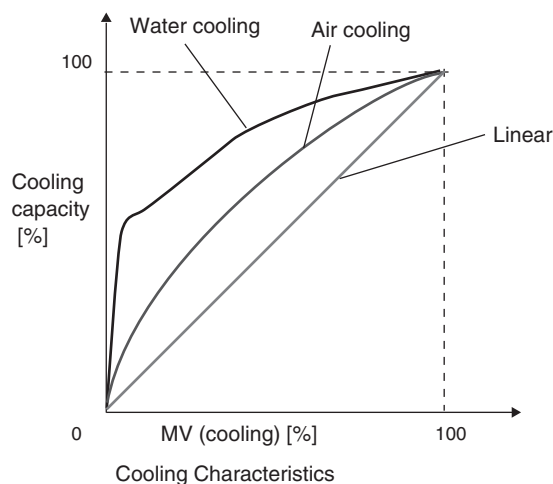
**OMPW****Minimum Output ON/OFF Band**

The control must be set to 2-PID control.



Function

This parameter sets the minimum ON/OFF width of the outputs that are assigned for the heating and cooling control outputs. You can set this parameter to prevent deterioration of a relay output.



Setting

Setting range	Unit	Default
0.0 to 50.0	%	1.0

PF PF Setting



Function

- This parameter sets the function of the PF Key.



Setting

- The default is SHFT (Digit Shift).

Set value	Setting	Function
OFF: $\bar{a}FF$	Disabled	Does not operate as a function key.
RUN: RUN	RUN	Specifies RUN status.
STOP: $St\bar{a}P$	STOP	Specifies STOP status.
R-S: $R-S$	Reversing RUN/STOP operation	Specifies reversing RUN/STOP operation status.
AT-2: $At-2$	100%AT Execute/Cancel	Specifies reversing 100% AT Execute/Cancel status. ^{*1}
AT-1: $At-1$	40%AT Execute/Cancel	Specifies reversing 40% AT Execute/Cancel status. ^{*1 *4}
LAT: LAt	Alarm Latch Cancel	Specifies canceling alarm latches. ^{*2}
A-M: $A-M$	Auto/Manual	Specifies reversing Auto/Manual status. ^{*3 *5}
PFDP: $PFdP$	Monitor/Setting Item	Specifies the monitor/setting item display. Select the monitor/setting item using the Monitor/Setting Item 1 to 5 parameters (Advanced Function Setting Level).
SHFT: $SHFt$	Digit Shift	Operates as a Digit Shift Key when settings are being changed.
A-UD: $A-Ud$	PID Update (Adaptive Control)	The PID is updated when PID constants that can be updated are calculated for adaptive control.
FA: FA	Automatic Filter Adjustment	Specifies reversing between performing and stopping operation after automatic filter adjustment.
W-HT: $W-Ht$	Water-cooling Output Adjustment	Specifies reversing between performing and stopping water-cooling output adjustment.

- *1 When AT cancel is specified, it means that AT is cancelled regardless of whether the AT currently being executed is 100% AT or 40% AT.
- *2 Alarms 1 to 4, the HB alarm, and the HS alarm are cancelled.
- *3 For details on auto/manual operations using the PF Key, refer to 5-16 *Performing Manual Control*.
- *4 This setting is disabled for heating/cooling control.
- *5 The function that is set for the PF Key is disabled if the same function is assigned to an event input.



● Related Parameters

Monitor/Setting Item 1 to 5 (Advanced Function Setting Level): Page 6-87

PFd1 Monitor/Setting Item 1**PFd2** Monitor/Setting Item 2**PFd3** Monitor/Setting Item 3

The PF Setting parameter must be set to PFDP.

PFd4 Monitor/Setting Item 4**PFd5** Monitor/Setting Item 5

MASK8



Function

- When the PF Key is set to display monitor/setting items, pressing the PF Key will display in order the contents of the Monitor/Setting Item 1 to 5 parameters. The contents of these parameters are shown in the following table. Refer to the relevant parameters for the setting/monitor ranges.
- The default value for the Monitor/Setting Item Display 1 parameter is 1.
The default value for the Monitor/Setting Item Display 2 to 5 parameters is 0.

Set value	Setting ^{*2}	Remarks	
		Monitor/Setting	Display
0	Disabled		---
1	PV/SP/Multi-SP No.	Can be set. (SP) ^{*1}	---
2	PV/SP/MV (Heating)	Can be set. (SP) ^{*1}	---
3	PV/SP/Soak time remain	Can be set. (SP) ^{*1}	---
4	Proportional band	Can be set.	<i>P</i>
5	Integral time	Can be set.	<i>I</i>
6	Derivative time	Can be set.	<i>D</i>
7	Alarm value 1	Can be set.	<i>AL - 1</i>
8	Alarm value upper limit 1	Can be set.	<i>AL 1H</i>
9	Alarm value lower limit 1	Can be set.	<i>AL 1L</i>
10	Alarm value 2	Can be set.	<i>AL - 2</i>
11	Alarm value upper limit 2	Can be set.	<i>AL 2H</i>
12	Alarm value lower limit 2	Can be set.	<i>AL 2L</i>
13	Alarm value 3	Can be set.	<i>AL - 3</i>
14	Alarm value upper limit 3	Can be set.	<i>AL 3H</i>
15	Alarm value lower limit 3	Can be set.	<i>AL 3L</i>
16	Alarm value 4	Can be set.	<i>AL - 4</i>
17	Alarm value upper limit 4	Can be set.	<i>AL 4H</i>
18	Alarm value lower limit 4	Can be set.	<i>AL 4L</i>
19	PV/SP/Internal SP	Can be set. (SP) ^{*1}	---
20	PV/SP/Alarm Value 1	Can be set. (SP) ^{*1}	---
21	Proportional Band (Cooling)	Can be set.	<i>[-P</i>
22	Integral Time (Cooling)	Can be set.	<i>[-I</i>
23	Derivative Time (Cooling)	Can be set.	<i>[-D</i>
24	PV/SP/MV (Cooling)	Can be set. (SP) ^{*1}	---

*1 With the E5CD or E5CD-B, only the PV and SP can be displayed.

*2 If the display condition is not met for even one of the set parameters, the monitor/setting item display will not appear.

SPd1 PV/SP No. 1 Display Selection**SPd2** PV/SP No. 2 Display Selection

Function

These parameters set the items to display on the No. 1 display, No. 2 display, and No. 3 display.



Setting

Set value	No. 1 display	No. 2 display	No. 3 display (E5ED or E5ED-B only)
0	Nothing is displayed.	Nothing is displayed.	Nothing is displayed.
1	Process value	Set point	Nothing is displayed.
2	Process value	Nothing is displayed.	Nothing is displayed.
3	Set point	SP (character display)	Nothing is displayed.
4	Process value	Set point	MV (heating)
5	Process value	Set point	Multi-SP No.*
6	Process value	Set point	Soak time remain *
7	Process value	Set point	Internal set point (ramp SP)
8	Process value	Set point	Alarm value 1*
9	Process value	Set point	MV (cooling)*

* Nothing is displayed on the No. 1, 2, and 3 displays if the display conditions are not met.

Parameter	Setting range	Default
PV/SP No. 1 Display Selection	0 to 9	4*
PV/SP No. 2 Display Selection		0

* The default value for the E5□D-□-8□□ is 0.

PVSt PV Status Display Function



Function

- This parameter sets a control or alarm status that is displayed alternately in 0.5-s cycles on the No. 1 display when the PV is set to be displayed in the No. 1 display.*1
- PV
- PV/SP*2
- PV/Manual MV
- PV/SP/Manual MV

*1 This includes the displays specified with the PV/SP No. 1 and PV/SP No. 2 Display Selection parameters.

*2 This includes when the PV/SP is selected for the Monitor/Setting Item parameter.



Setting

Setting range		Default
<i>OFF</i> :	No PV status display	<i>OFF</i>
<i>MANU</i> :	MANU is alternately displayed during manual control.	
<i>STOP</i> :	STOP is alternately displayed while operation is stopped.	
<i>ALM1</i> :	ALM1 is alternately displayed during Alarm 1 status.	
<i>ALM2</i> :	ALM2 is alternately displayed during Alarm 2 status.	
<i>ALM3</i> :	ALM3 is alternately displayed during Alarm 3 status.	
<i>ALM4</i> :	ALM4 is alternately displayed during Alarm 4 status.	
<i>ALM</i> :	ALM is alternately displayed when Alarm 1, 2, 3, or 4 is set to ON.	
<i>HA</i> :	HA is alternately displayed when an HB alarm or HS alarm is ON.	



See

● Related Parameters

Process Value/Set Point (Operation Level): Page 6-8

PV/MV (Manual MV) (Manual Control Level): Page 6-39

SVSt SV Status Display Function



Function

- This parameter sets a control or alarm status that is displayed alternately in 0.5-s cycles on the No. 2 display when the PV is set to be displayed in the No. 1 display.*¹
 - PV
 - PV/SP*²
 - PV/Manual MV
 - PV/SP/Manual MV
- *1 This includes the displays specified with the PV/SP No. 1 and PV/SP No. 2 Display Selection parameters.
- *2 This includes when the PV/SP is selected for the Monitor/Setting Item parameter.



Setting

	Setting range	Default
<i>OFF</i> :	No SV status display	<i>OFF</i>
<i>MANU</i> :	MANU is alternately displayed during manual control.	
<i>STOP</i> :	STOP is alternately displayed while operation is stopped.	
<i>ALM1</i> :	ALM1 is alternately displayed during Alarm 1 status.	
<i>ALM2</i> :	ALM2 is alternately displayed during Alarm 2 status.	
<i>ALM3</i> :	ALM3 is alternately displayed during Alarm 3 status.	
<i>ALM4</i> :	ALM4 is alternately displayed during Alarm 4 status.	
<i>ALM</i> :	ALM is alternately displayed when Alarm 1, 2, 3, or 4 is set to ON.	
<i>HA</i> :	HA is alternately displayed when an HB alarm or HS alarm is ON.	



See

● Related Parameters

Process Value/Set Point (Operation Level): Page 6-8
 PV/MV (Manual MV) (Manual Control Level): Page 6-39

d.REF Display Refresh Period



Function

- This parameter delays the display refresh period for monitor values. Only display refreshing is delayed, and the refresh period for process values used in control is not changed.
- This function is disabled by setting the parameter to OFF.
 If this function is disabled, the display refresh period will be the same as the sampling period, 50 ms.



Setting

Setting range	Unit	Default
OFF, 0.25, 0.5, 1.0	Seconds	0.25

LCT

LCT Cooling Output Minimum ON Time

The control output on the cooling side must be a relay or voltage output. Heating/cooling control must be used, 2-PID control must be used, and the Heating/Cooling Tuning Method parameter must be set to air or water cooling.



Function

- This parameter sets the minimum output ON time for the cooling-side control output during autotuning.
- Set the time in seconds that is required for the operation of the actuator that is connected to the cooling-side control.

Example: The following calculation is used when the configuration consists of the E5□D (with a relay output), a relay, and a solenoid valve.

$$(0.02 \text{ s (fixed)} + 0.02 \text{ s} + 0.06 \text{ s}) \times 2 \text{ (safety factor)} = 0.2 \text{ s}$$

- * The default setting of this parameter is based on the operating time of an actuator on a standard extruder.



Setting

Setting range	Unit	Default
0.1 to 1.0	Seconds	0.2

A-dv

Adaptive Control Operation Possible Deviation

The control must be standard control and 2-PID control. The input type must be set for a temperature input. The Adaptive Control parameter must not be set to "Disabled."

This parameter gives the possible deviation between the process value (PV) and set point (SP) for adaptive control.



Function

If the PV at the start of adaptive control is beyond this deviation, evaluation of the adaptive control system performance operates.

To ensure the performance of adaptive control, do not set a value less than 50%.

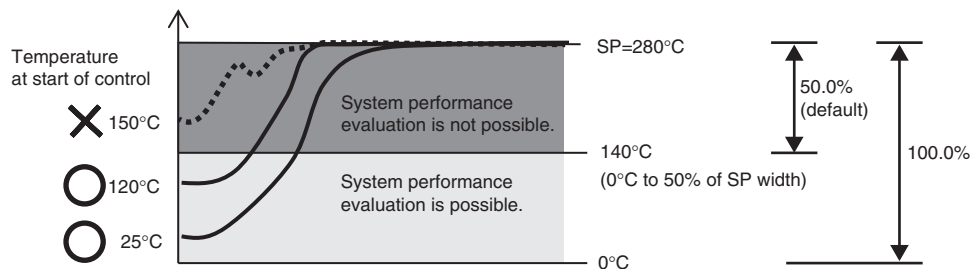

Setting

Setting range	Unit	Default
0.0 to 100.0	%	50.0
0°C (32°F) to Set point = 100%		

● **Related Parameters**



See

Adaptive Control (Initial Setting Level): Page 6-45

*A-Sd***System Fluctuation Reference Deviation**

The control must be standard control and 2-PID control.

The input type must be set for a temperature input. The Adaptive Control parameter must not be set to "Disabled."



- When the Adaptive Control parameter is set to "Notification," the value set for this parameter is used to determine when to provide notification.
- If the rate of change in the proportional band that is calculated for system performance evaluation exceeds this reference value, the **A** indicator lights to provide notification of a temperature variation in the system.



Setting range	Unit	Default
0.0 to 100.0	%	15.0

- **Related Parameters**



Adaptive Control (Initial Setting Level): Page 6-45

*FASP***Automatic Filter Adjustment Seal Period**

The control must be standard control and 2-PID control.

The parameter gives the seal period of the automatic filter adjustment.



- This is the period of small temperature variations (up to several seconds) that occur in one seal.
- Normally, use the default for this parameter.



Setting range	Unit	Default
0.1 to 10.0	Seconds	2.0

- **Related Parameters**



Automatic Filter Adjustment (Adjustment Level): Page 6-23

FRHP**Automatic Filter Adjustment
Hunting Monitor Period****The control must be standard control and 2-PID
control.**

This parameter gives the hunting monitor period of automatic filter adjustment.



Function

- This is the period of large temperature variations (several tens of seconds or longer) when packaging.
- Normally, use the default for this parameter.



Setting

Setting range	Unit	Default
10 to 1999	Seconds	200

● Related Parameters



Automatic Filter Adjustment (Adjustment Level): Page 6-23

W-LC**Water-cooling Proportional Band
Increase Constant**

**The control must be set to heating/cooling control
and 2-PID control.
The input type must be set for a temperature input.
The Heating/Cooling Tuning Method must be set to
“Water cooling.”**

This parameter is used for water-cooling output adjustment.



Function

- This parameter gives the increase constant when the value of the cooling proportional band is adjusted to reduce hunting. This function works to suppress an excessive cooling output that may cause hunting when the cooling proportional band is increased
- Normally, use the default for this parameter.



Setting

Setting range	Default
1.00 to 10.00	1.70

● Related Parameters



Water-cooling Output Adjustment (Adjustment Level): Page 6-25

W-dC**Water-cooling Proportional Band
Decrease Constant**

The control must be set to heating/cooling control and 2-PID control.
The input type must be set for a temperature input.
The Heating/Cooling Tuning Method must be set to "Water cooling."

This parameter is used for water-cooling output adjustment.



- This parameter gives the decrease constant when the value of the cooling proportional band is adjusted to optimize disturbance response. This function works to increase an insufficient cooling output that may reduce disturbance response when the cooling proportional band is decreased.
- Normally, use the default for this parameter.



Setting range	Default
0.10 to 0.99	0.90

- **Related Parameters**



Water-cooling Output Adjustment (Adjustment Level): Page 6-25

PWtM**Power ON Time Monitor**

- This parameter gives the total time that the power supply has been ON.
- You cannot initialize the power ON time data.



Monitor range	Unit	Default
0 to 9999	10 hours	0

RbtM**Ambient Temperature Monitor**

- The parameter monitors the ambient temperature around the Digital Controller terminals.
- * This temperature is for reference only.



Monitor range	Unit
-30 to 75	°C
10 to 171	°F

RA1M
RA2M

Control Output 1 ON/OFF Count Monitor
Control Output 2 ON/OFF Count Monitor

Control outputs 1 and 2 must be supported. Relay or voltage outputs (for driving SSR) must be used.



Function

- These parameters monitor the number of times that control outputs 1 and 2 are turned ON and OFF.
- These parameters are not initialized for the Parameter Initialization parameter. To initialize them, reset (initialize) them with the ON/OFF Counter Reset parameter.



Setting

Monitor range	Unit	Default
0 to 9999	100 times	0



See

● Related Parameters

ON/OFF Counter Reset (Advanced Function Setting Level): Page 6-95

RAC

ON/OFF Counter Reset

Control outputs 1 and 2 must be supported. Relay or voltage outputs (for driving SSR) must be used.



Function

This parameter resets the ON/OFF counter for specified control outputs.



Setting

Setting range	Default
0: Resetting is disabled.	0
1: Control Output 1 ON/OFF Count Monitor parameter is reset.	
2: Control Output 2 ON/OFF Count Monitor parameter is reset.	



See

● Related Parameters

Control Output 1 ON/OFF Count Monitor (Advanced Function Setting Level): Page 6-95

Control Output 2 ON/OFF Count Monitor (Advanced Function Setting Level): Page 6-95

PMSL

Parameter Mask Setting



Function

- You can use a key operation to hide parameters that do not need to be displayed.
- This allows you to prevent incorrect operations for parameters or to change the parameter display configuration according to the application.



Operation

If you set the Parameter Mask Setting parameter to ON, Parameter Mask Mode is entered. Refer to *5-12-1 Parameter Mask Setting* for information on masking parameters after you enter Parameter Mask Mode.



See

● Related Parameters



Parameter Mask Enable (Protect Level): Page 6-6

CMOV**Move to Calibration Level****Initial setting/communications protect must be 0.****MASK8**

This parameter sets the password to move to the Calibration Level.



Function

- Set the password to move to the Calibration Level. The password is 1201.
- Move to the Calibration Level either by pressing the  Key or  Key or by waiting for two seconds to elapse.



See

- **Related Parameter**

Initial Setting/Communications Protect (Protect Level): Page 6-4

6-9 Communications Setting Level

<i>PSEL</i>	Protocol Setting	Communications must be supported.
<i>U-Nō</i>	Communications Unit No.	
<i>bPS</i>	Communications Baud Rate	
<i>LEN</i>	Communications Data Length	CompoWay/F must be selected as the protocol.
<i>SbLt</i>	Communications Stop Bits	CompoWay/F must be selected as the protocol.
<i>PRtY</i>	Communications Parity	CompoWay/F or Modbus must be selected as the protocol.
<i>SdWt</i>	Send Data Wait Time	
<i>RAMM</i>	Write Mode	
<i>MAXU</i>	Highest Communications Unit No.	FINS, MCP4, or FXP4 must be selected as the protocol.
<i>AREA</i>	Area	FINS, MCP4, or FXP4 must be selected as the protocol.
<i>AdRH</i>	First Address Upper Word	FINS, MCP4, or FXP4 must be selected as the protocol.
<i>AdRL</i>	First Address Lower Word	FINS, MCP4, or FXP4 must be selected as the protocol.
<i>RWAt</i>	Receive Data Wait Time	FINS, MCP4, or FXP4 must be selected as the protocol.
<i>UNLt</i>	Communications Node Number	FINS, MCP4, or FXP4 must be selected as the protocol.
<i>UP*</i>	Upload Setting * (* = 1 to 13)	FINS, MCP4, Modbus, or FXP4 must be selected as the protocol.
<i>dNP*</i>	Download Setting * (* = 1 to 13)	FINS, MCP4, Modbus, or FXP4 must be selected as the protocol.
<i>CōPY</i>	Copying Parameter Settings	FINS, MCP4, or FXP4 must be selected as the protocol and the communications unit number must be set to 0.



Function

- Each parameter is enabled when the power is reset.
- Match the communications specifications of the E5□D and the host computer. If multiple devices are connected, ensure that the communications specifications for all devices in the system (except the Communications unit number) are the same.
- Parameters in the Communications Level are displayed only for models that support communications. Refer to the *E5□D Digital Controllers Communications Manual* (Cat. No. H225) for details.



Setting

Item	Display	Set values	Settings	Default
Protocol setting	<i>PSEL</i>	<i>COMP</i> <i>MODB</i> <i>NONE</i> <i>FINS</i> <i>MC4</i> <i>FP4</i>	CompoWay/F Modbus Disabled Component communications Host Link (FINS) MC Protocol (format 4) Dedicated protocol (format 4)	<i>COMP</i>
Communications Unit No.	<i>U-NO</i>	0 to 99	0 to 99	<i>1</i>
Communications baud rate	<i>BPS</i>	9.6/19.2/38.4/57.6/ 115.2 (Kbps)	9.6/19.2/38.4/57.6/115.2 (kbps)	<i>9.6</i>
Communications data length	<i>LEN</i>	7 or 8 bits	7 or 8 bits	<i>7</i>
Stop bits	<i>SBIT</i>	1 or 2 bits	1 or 2 bits	<i>2</i>
Communications parity	<i>PRTY</i>	<i>NONE</i> <i>EVEN</i> <i>ODD</i>	None, Even, Odd	<i>EVEN</i>
Send data wait time	<i>SDWT</i>	0 to 99	0 to 99 (ms)	<i>20</i>
Write Mode	<i>WRMM</i>	<i>BACKUP</i> <i>RAM</i>	Backup Mode RAM Write Mode	<i>BACKUP</i>

* Writing with communications is enabled if you set the Protocol Setting parameter to Host Link (FINS), MC protocol (format 4), or dedicated protocol (format 4).



See

● Related Parameter

Communications Writing (Adjustment Level): Page 6-19

If the Protocol Setting parameter is set to one of the following settings, the setting parameters for programless communications are displayed. Refer to the *E5□D Digital Controllers Communications Manual* (Cat. No. H225) for details.

Protocol Setting = Host Link (FINS), MC Protocol (Format 4), or Dedicated Protocol (Format 4)

Parameter	Parameter display	Display	Settings	Default
Highest Communications Unit No.	<i>MAXU</i>	<i>0 to 99</i>	0 to 99	0
Area	<i>AREA</i>	<i>0 to 25</i>	0 to 25	0
First Address Upper Word	<i>ADDRH</i>	<i>0 to 99</i>	0 to 99	0
First Address Lower Word	<i>ADDRL</i>	<i>0 to 9999</i>	0 to 9999	0
Receive Data Wait Time	<i>RWRT</i>	<i>100 to 9999</i>	100 to 9999 ms	1000
Communications Node Number	<i>UNCL</i>	<i>0 to 99</i>	0 to 99	0
Upload Settings 1 to 13*	<i>UPD 1 to 13</i>	<i>0 to 108</i>	0 to 108	
Download Settings 1 to 13	<i>DND 1 to 13</i>	<i>30 to 108</i>	30 to 108	
Copy	<i>COPY</i>	<i>OFF, ALL, 1 to 199</i>		OFF

- * You cannot use Upload Setting 13 parameter if you set the dedicated protocol (format 4).
If the Protocol Setting parameter is set to Modbus, only the above Upload Settings 1 to 13 and Download Settings 1 to 13 are displayed.



User Calibration

7-1	User Calibration	7-2
7-2	Parameter Structure	7-3
7-3	Thermocouple Calibration	7-4
7-4	Resistance Thermometer Calibration	7-7
7-5	Calibrating Analog Input	7-9
7-7	Checking Indication Accuracy	7-15

7-1 User Calibration

The E5□D is correctly calibrated before it is shipped from the factory. Normally it does not need to be calibrated by the user.

If, however, it must be calibrated by the user, use the parameters for calibrating temperature input and analog input. OMRON, however, cannot ensure the results of calibration by the user. Also, calibration data is overwritten with the latest calibration results. The default calibration settings cannot be restored after user calibration. Perform user calibration with care.

● Calibrating Inputs

The input type selected in the parameter is used for calibration. The input types are as follows:

- Thermocouple: 16 types
- Infrared temperature sensor: 4 types
- Resistance thermometer: 5 types
- Current input: 2 types
- Voltage input: 3 types

● Registering Calibration Data

The new calibration data for each item is temporarily registered. It can be officially registered as calibration data only when all items have been calibrated to new values. Therefore, be sure to temporarily register all items when you perform the calibration. When the data is registered, it is also recorded that user calibration has been performed.

Prepare separate measuring devices and equipment for calibration. For details on how to handle measuring devices and equipment, refer to the respective instruction manuals.

● Wiring the E5□D-B (Models with Push-In Plus Terminal Blocks)

When connecting two wires to one terminal to calibrate the E5□D-B, do so as given below.

- Using Stranded Wire

Use AWG24 to AWG20 (0.25 to 0.5 mm²) stranded wires and connect two wires to the terminal.

- Using Twin Ferrules

Use AWG22 to AWG18 (0.5 to 0.75 mm²) wires.

Attach the two wires to the twin ferrule first, and then connect the ferrule to the terminal.

Recommended Twin Ferrules

Manufacturer	Model number
Phoenix Contact	AL-TWIN2 × 0.5-8WH AL-TWIN2 × 0.75-8GY
Weidmuller	H0.5/14 H0.75/14
Wago	FE-0.5-8W-WH FE-0.75-8W-GY

7-2 Parameter Structure

- To execute user calibration, enter the password "1201" at the Move to Calibration Level parameter in the Advanced Function Setting Level. The mode will be changed to the calibration mode, and *Adj* will be displayed.
- The Move to Calibration Level parameter may not be displayed when the user is doing the calibration for the first time. If this happens, set the Initial Setting/Communications Protect parameter in the Protect Level to 0 before moving to the Advanced Function Setting Level.
- The calibration mode is ended by turning the power OFF.
- The parameter calibrations in the calibration mode are structured as shown below.

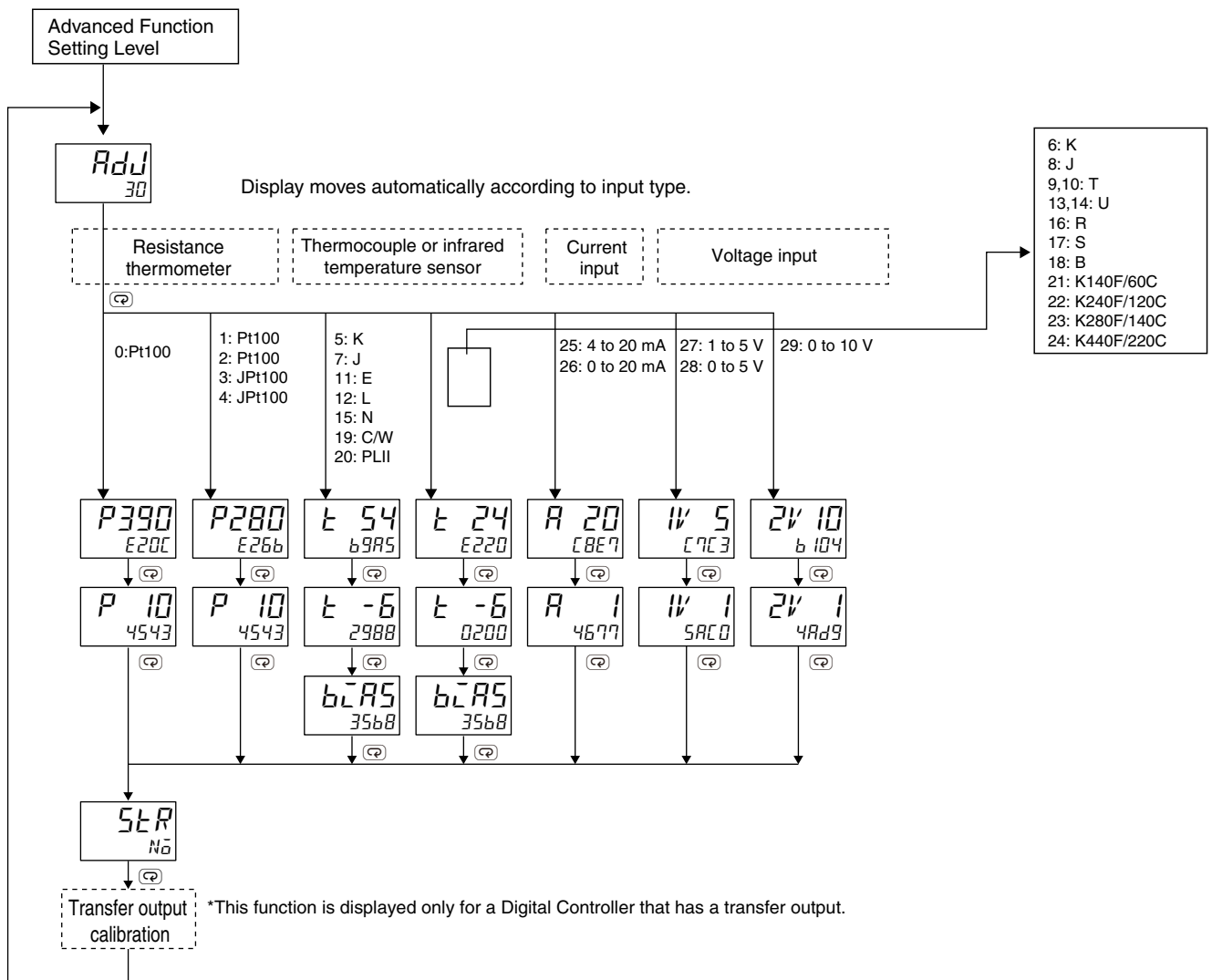

When calibration has been performed after purchase, the user calibration information shown in the following illustration will be displayed when moving to the Calibration Level.

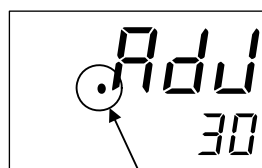

A dot is displayed.

7-3 Thermocouple Calibration

- Calibrate according to the type of thermocouple: thermocouple group 1 (input types 5, 7, 11, 12, 15, 19, and 20) and thermocouple group 2 (input types 6, 8, 9, 10, 13, 14, 16, 17, 18, 21, 22, 23, and 24).
- When calibrating, do not cover the bottom of the Digital Controller.
- If you perform user calibration of the thermocouple, the temperature on the ambient temperature monitor will also be affected.

● Preparations

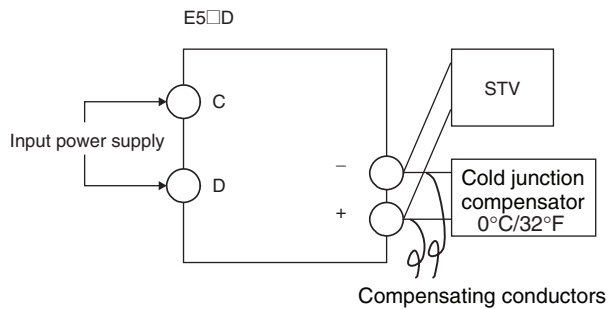

The terminal numbers are as follows:

- Input Terminals (Negative and Positive)
E5CD: 5 and 6
E5ED: 23 and 24
- Input Power Supply (C and D)
E5CD: 11 and 12
E5ED: 1 and 2

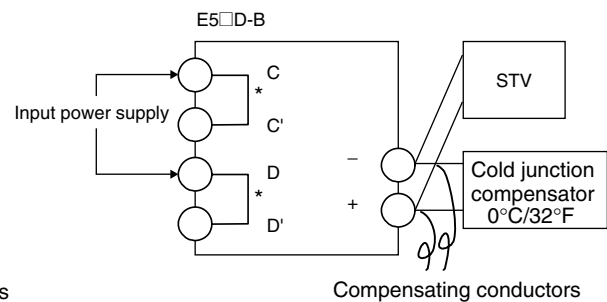

* Common terminals are indicated with asterisks (*).

The terminal numbers are as follows:

- Input Terminals (Negative and Positive)
E5CD-B: 7 and 8
E5ED-B: 31 and 32
- Input Power Supply (C or C', and D or D')
E5CD-B: 13 or 14, and 15 or 16
E5ED-B: 1 or 2, and 3 or 4

- Set the cold junction compensator designed for compensation of internal thermocouples to 0°C. Make sure that internal thermocouples are disabled (i.e., that tips are open).
- In the above figure, STV indicates a standard DC current/voltage source.
- Use the compensating conductor designed for the selected thermocouple. When thermocouples R, S, E, B, C/W, or PLII or an infrared temperature sensor is used, the cold junction compensator and the compensating conductor can be substituted with the cold junction compensator and the compensating conductor for thermocouple K.

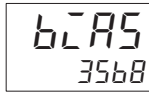
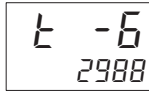

6. When the Ⓢ Key is pressed, the status changes as shown to the left. Set the STV to -6 mV. Allow the count value on the No. 2 display to fully stabilize, then press the Ⓢ Key to temporarily register the calibration settings. If this count value is outside of the specified range, the No. 2 display will flash and the count value will not be temporarily registered.

7. When the Ⓢ Key is pressed, the status changes as shown to the left.

8. Change the wiring as follows:

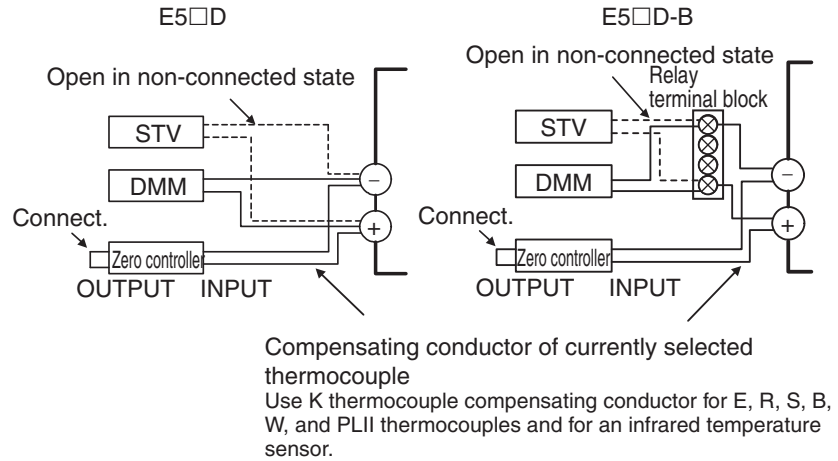

Disconnect the STV to enable the thermocouple of the cold junction compensator. When doing this, be sure to disconnect the wiring on the STV side.

9. Allow the count value on the No. 2 display to fully stabilize, then press the Ⓢ Key to temporarily register the calibration settings.
10. When the Ⓢ Key is pressed, the status changes as shown to the left. The data to be temporarily registered is not displayed if it is not complete. Press the Ⓢ Key. The No. 2 display changes to $4E5$. Release the key and wait two seconds or press the Ⓢ Key. This stores the temporarily registered calibration data to non-volatile memory. To cancel the saving of temporarily registered calibration data to non-volatile memory, press the Ⓢ Key (while $N\bar{0}$ is displayed in the No. 2 display) without pressing the Ⓢ Key.
11. The calibration mode is ended by turning the power OFF. For Digital Controllers that have a transfer output, you can continue by calibrating the transfer output. For detailed setting methods, refer to *7-6 Calibrating the Transfer Output*.

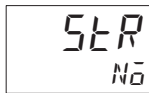

7-4 Resistance Thermometer Calibration

In this example, calibration is shown for Digital Controller with a resistance thermometer set as the input type. Use connecting wires of the same thickness

1. Connect the power supply.
2. Connect a precision resistance box (called a "6-dial variable resistor" in this manual) to the resistance thermometer input terminals, as shown in the following diagram.

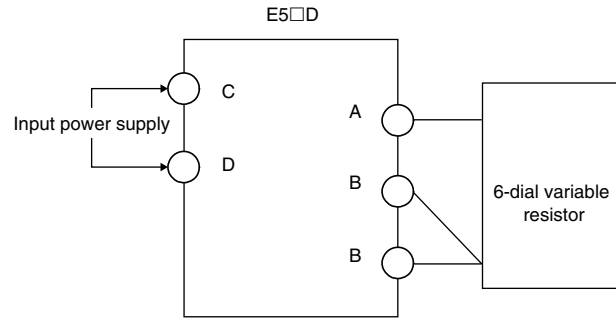

The terminal numbers are as follows:

- Input Terminals (A/B/B)
 - E5CD: 4, 5, and 6
 - E5ED: 22, 23, and 24
- Input Power Supply (C/D)
 - E5CD: 11 and 12
 - E5ED: 1 and 2

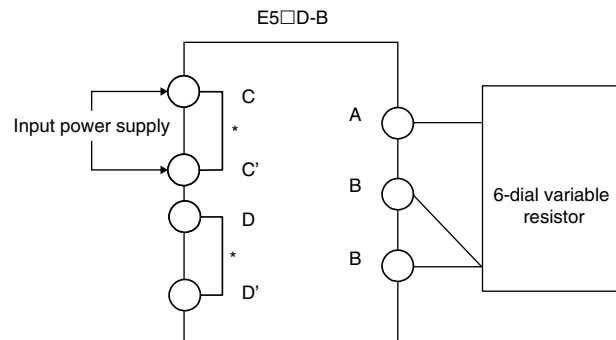

* Common terminals are indicated with asterisks (*).

The terminal numbers are as follows:

- Input Terminals (A/B/B)
 - E5CD-B: 6, 7, and 8
 - E5ED-B: 30, 31, and 32
- Input Power Supply (C or C', and D or D')
 - E5CD-B: 13 or 14, and 15 or 16
 - E5ED-B: 1 or 2, 3 or 4

3. Turn the power ON.
4. Move to the Calibration Level.
This starts the 30-minute aging timer. This timer provides an approximate timer for aging. After 30 minutes have elapsed, the No. 2 display changes to 0. You can advance to the next step in this procedure even if 0 is not displayed.

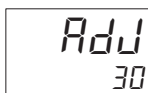

- Input type 0:

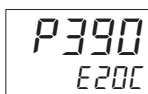

- Input types 1, 2, 3, 4:

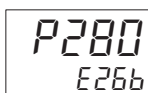

5. Execute calibration for the main input.

Press the Ⓢ Key to display the count value for each input type.

The No. 2 display at this time shows the currently entered count value in hexadecimal. Set the 6-dial as follows:

- Input type 0: 390 Ω
- Input type 1, 2, 3 or 4: 280 Ω

Allow the count value on the No. 2 display to fully stabilize, then press the Ⓢ Key to temporarily register the calibration settings.

If this count value is outside of the specified range, the No. 2 display will flash and the count value will not be temporarily registered.

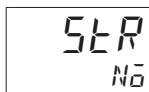
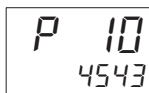

6. When the \odot Key is pressed, the status changes as shown to the left.
 Set the 6-dial to 10 Ω .
 Allow the count value on the No. 2 display to fully stabilize, then press the \odot Key to temporarily register the calibration settings.
 If this count value is outside of the specified range, the No. 2 display will flash and the count value will not be temporarily registered.

7. When the \odot Key is pressed, the status changes as shown to the left.
 The data to be temporarily registered is not displayed if it is not complete.
 Press the \odot Key. The No. 2 display changes to 455. Release the key and wait two seconds or press the \odot Key. This stores the temporarily registered calibration data to non-volatile memory.
 To cancel the saving of temporarily registered calibration data to non-volatile memory, press the \odot Key (while No is displayed in the No. 2 display) without pressing the \odot Key.

8. The calibration mode is quit by turning the power OFF.
 For Digital Controllers that have a transfer output, you can continue by calibrating the transfer output. For detailed setting methods, refer to *7-6 Calibrating the Transfer Output*.

7-5 Calibrating Analog Input

● Calibrating a Current Input

In this example, calibration is shown for a Digital Controller with an analog input, with a current input set as the input type.

1. Connect the power supply.
2. Connect an STV and DMM to the current input terminals, as shown in the following diagram.

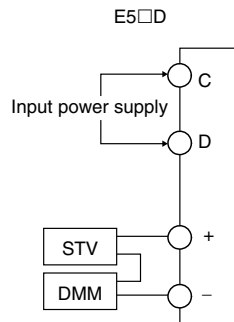

The terminal numbers are as follows:

- Input Terminals (Negative and Positive)
E5CD: 5 and 4
E5ED: 23 and 22
- Input Power Supply (C/D)
E5CD: 11 and 12
E5ED: 1 and 2

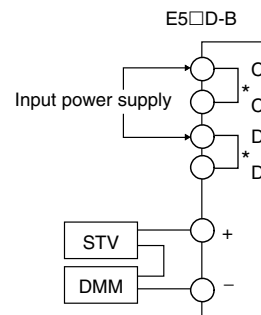

* Common terminals are indicated with asterisks (*).

The terminal numbers are as follows:

- Input Terminals (Negative and Positive)
E5CD-B: 7 and 6
E5ED-B: 31 and 30
- Input Power Supply (C or C', and D or D')
E5CD-B: 13 or 14, and 15 or 16
E5ED-B: 1 or 2, and 3 or 4

3. Turn the power ON.

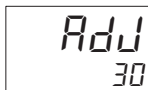

4. Move to the Calibration Level.

This starts the 30-minute aging timer. This timer provides an approximate timer for aging. After 30 minutes have elapsed, the No. 2 display changes to 0. You can advance to the next step in this procedure even if 0 is not displayed.

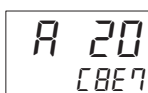

5. When the Ⓢ Key is pressed, the status changes as shown to the left.

The No. 2 display at this time shows the currently entered count value in hexadecimal. Set the STV to 20 mA.

Allow the count value on the No. 2 display to fully stabilize, then press the Ⓢ Key to temporarily register the calibration settings.

If this count value is outside of the specified range, the No. 2 display will flash and the count value will not be temporarily registered.

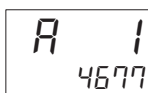

6. When the Ⓢ Key is pressed, the status changes as shown to the left.

Set the STV to 1 mA.

Allow the count value on the No. 2 display to fully stabilize, then press the Ⓢ Key to temporarily register the calibration settings.

If this count value is outside of the specified range, the No. 2 display will flash and the count value will not be temporarily registered.

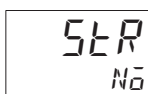

7. When the Ⓢ Key is pressed, the status changes as shown to the left.

The data to be temporarily registered is not displayed if it is not complete.

Press the Ⓢ Key. The No. 2 display changes to 4E5 . Release the key and wait two seconds or press the Ⓢ Key. This stores the temporarily registered calibration data to non-volatile memory.

To cancel the saving of temporarily registered calibration data to non-volatile memory, press the Ⓢ Key (while N0 is displayed in the No. 2 display) without pressing the Ⓢ Key.

8. The calibration mode is ended by turning the power OFF.
For Digital Controllers that have a transfer output, you can continue by calibrating the transfer output. For detailed setting methods, refer to *7-6 Calibrating the Transfer Output*.

● **Calibrating a Voltage Input**

In this example, calibration is shown for a Digital Controller with an analog input, with a voltage input set as the input type.

1. Connect the power supply.
2. Connect an STV and DMM to the voltage input terminals, as shown in the following diagram.

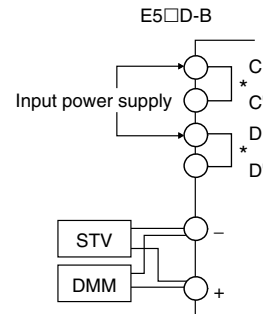
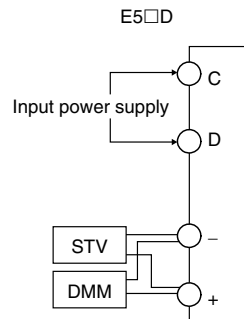

* Common terminals are indicated with asterisks (*).

The terminal numbers are as follows:

- Input Terminals (Negative and Positive)
E5CD: 5 and 6
E5ED: 23 and 24
- Input Power Supply (C/D)
E5CD: 11 and 12
E5ED: 1 and 2

The terminal numbers are as follows:

- Input Terminals (Negative and Positive)
E5CD-B: 7 and 8
E5ED-B: 31 and 32
- Input Power Supply (C or C', and D or D')
E5CD-B: 13 or 14, and 15 or 16
E5ED-B: 1 or 2, and 3 or 4

3. Turn the power ON.
4. Move to the Calibration Level.
This starts the 30-minute aging timer. This timer provides an approximate timer for aging. After 30 minutes have elapsed, the No. 2 display changes to 0. You can advance to the next step in this procedure even if 0 is not displayed.

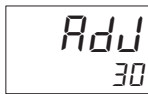

- Input type 27 or 28: 5. When the ☐ Key is pressed, the status changes as shown to the left. The No. 2 display at this time shows the currently entered count value in hexadecimal. Set the STV as follows:

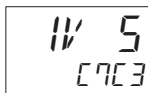

- Input type 29: Allow the count value on the No. 2 display to fully stabilize, then press the ☑ Key to temporarily register the calibration settings. If this count value is outside of the specified range, the No. 2 display will flash and the count value will not be temporarily registered.

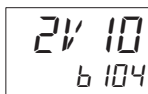



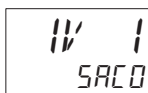

- Input type 27 or 28: 6. When the ☐ Key is pressed, the status changes as shown to the left. Set the STV as follows:

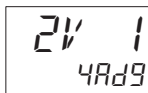

- Input type 29: Allow the count value on the No. 2 display to fully stabilize, then press the ☑ Key to temporarily register the calibration settings. If this count value is outside of the specified range, the No. 2 display will flash and the count value will not be temporarily registered.





7. When the  Key is pressed, the status changes as shown to the left.
The data to be temporarily registered is not displayed if it is not complete.
Press the  Key. The No. 2 display changes to *4E5*. Release the key and wait two seconds or press the  Key. This stores the temporarily registered calibration data to non-volatile memory.
To cancel the saving of temporarily registered calibration data to non-volatile memory, press the  Key (while *No* is displayed in the No. 2 display) without pressing the  Key.
8. The calibration mode is ended by turning the power OFF.
For Digital Controllers that have a transfer output, you can continue by calibrating the transfer output. For detailed setting methods, refer to *7-6 Calibrating the Transfer Output*.

7-6 Calibrating the Transfer Output

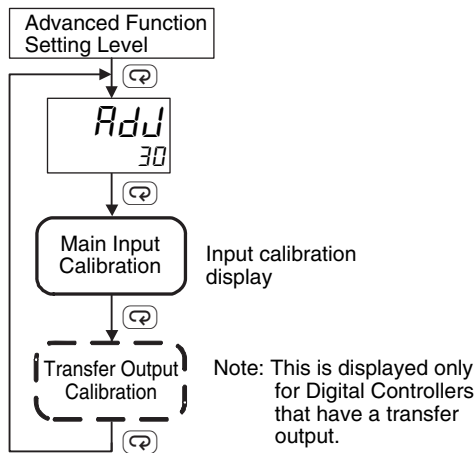

For Digital Controllers that have a transfer output, the transfer output calibration display will be displayed after input calibration has been completed.

Use the following procedure to calibrate the transfer output for 4 to 20 mA.

1. Connect a DMM to the transfer output terminals.

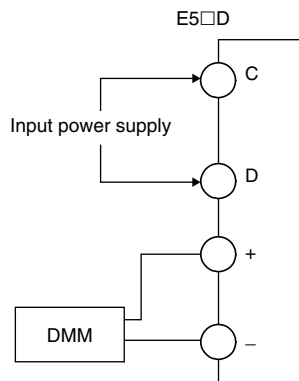

The terminal numbers are as follows:

- Transfer Output Terminals (Positive and Negative)

E5CD: 17 and 18

E5ED: 32 and 33

- Input Power Supply (C/D)

E5CD: 11 and 12

E5ED: 1 and 2

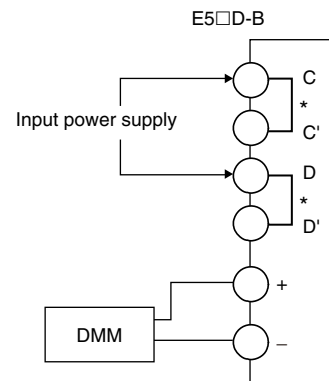

* Common terminals are indicated with asterisks (*).

The terminal numbers are as follows:

- Transfer Output Terminals (Positive and Negative)

E5CD-B: 23 and 24

E5ED-B: 43 and 44

- Input Power Supply (C or C', and D or D')

E5CD-B: 13 or 14, and 15 or 16

E5ED-B: 1 or 2, and 3 or 4

5LR
No

A20.0
52AC

A4.0
0037

2. Press the Key to display the parameter for the transfer output.
3. The calibration display for 20 mA will be displayed. Press the or Key until the DMM monitor value changes to 20 mA. Press the Key. The calibration settings will be temporarily registered.
4. The calibration display for 4 mA will be displayed. Press the or Key until the DMM monitor value changes to 4 mA. Press the Key. The calibration settings will be temporarily registered.



- To cancel saving the temporarily registered calibration data to non-volatile memory, press the Ⓢ Key without pressing the Ⓜ Key, i.e., while No is displayed in the No. 2 display.
Press the Ⓜ Key. The No. 2 display changes to 5E5 . Release the key and wait 2 seconds or press the Ⓢ Key. This saves the temporarily registered calibration data in non-volatile memory.
- The Calibration Mode is ended by turning OFF the power supply.

Use the following procedure to calibrate the transfer output for 1 to 5 V.

- Connect a DMM to the transfer output terminals.

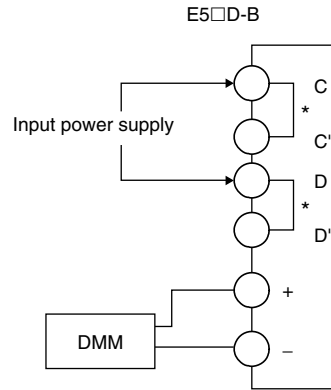
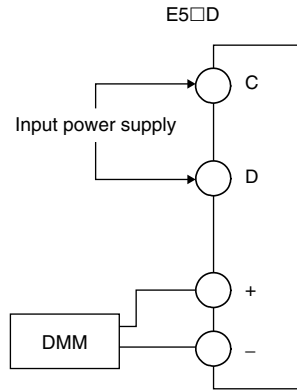

* Common terminals are indicated with asterisks (*).

- The terminal numbers are as follows:
- Transfer Output Terminals (Positive and Negative)
E5CD: 16 and 18
E5ED: 31 and 33
 - Input Power Supply (C/D)
E5CD: 11 and 12
E5ED: 1 and 2

- The terminal numbers are as follows:
- Transfer Output Terminals (Positive and Negative)
E5CD-B: 22 and 24
E5ED-B: 42 and 44
 - Input Power Supply (C or C', and D or D')
E5CD-B: 13 or 14, and 15 or 16
E5ED-B: 1 or 2, and 3 or 4

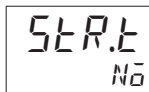
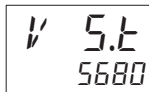
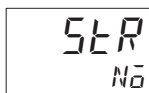

- Press the Ⓢ Key to display the parameter for the transfer output.
- The calibration display for 5 V will be displayed. Press the Ⓜ or Ⓢ Key until the DMM monitor value changes to 5 V.
Press the Ⓢ Key. The calibration settings will be temporarily registered.
- The calibration display for 1 V will be displayed. Press the Ⓜ or Ⓢ Key until the DMM monitor value changes to 1 V.
Press the Ⓢ Key. The calibration settings will be temporarily registered.
- To cancel saving the temporarily registered calibration data to non-volatile memory, press the Ⓢ Key without pressing the Ⓜ Key, i.e., while No is displayed in the No. 2 display.
Press the Ⓜ Key. The No. 2 display changes to 5E5 . Release the key and wait 2 seconds or press the Ⓢ Key. This saves the temporarily registered calibration data in non-volatile memory.
- The Calibration Mode is ended by turning OFF the power supply.

7-7 Checking Indication Accuracy

- After calibrating the input, be sure to check the indication accuracy to make sure that the calibration has been executed correctly.
- Operate the E5□D in the process value/set point monitor mode.
- Check the indication accuracy at the following three values: upper limit, lower limit, and mid-point.
- To check the range of an infrared sensor, set the input type parameter to 6 (i.e., a K thermocouple) and input a voltage that is equivalent to the starting power of a K thermocouple.

● Thermocouple or Infrared Temperature Sensor

- Preparations

The diagram below shows the required device connections. Make sure that the E5□D and cold junction compensator are connected by a compensating conductor for the thermocouple that is to be used during actual operation.

E5□D

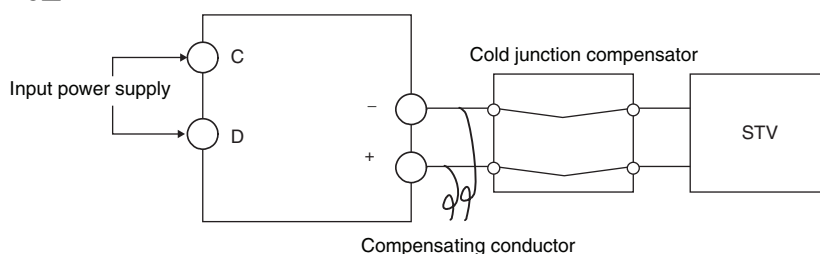

The terminal numbers are as follows:

- | | |
|---|----------------------------|
| • Input Terminals (Negative and Positive) | • Input Power Supply (C/D) |
| E5CD: 5 and 6 | E5CD: 11 and 12 |
| E5ED: 23 and 24 | E5ED: 1 and 2 |

E5□D-B

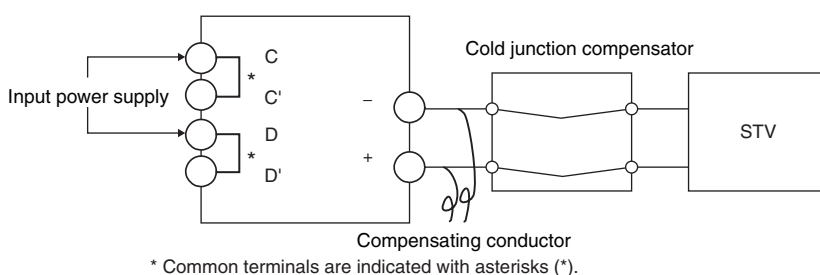

* Common terminals are indicated with asterisks (*).

The terminal numbers are as follows:

- | | |
|---|---|
| • Input Terminals (Negative and Positive) | • Input Power Supply (C or C', and D or D') |
| E5CD-B: 7 and 8 | E5CD-B: 13 or 14, and 15 or 16 |
| E5ED-B: 31 and 32 | E5ED-B: 1 or 2, and 3 or 4 |

- Operation

Make sure that the cold junction compensator is at 0°C, and set the STV output to the voltage equivalent of the starting power of the check value.

The cold junction compensator and compensation conductor are not required when an external cold junction compensation method is used.

● Resistance Thermometer

• Preparations

The diagram below shows the required device connections.

E5□D

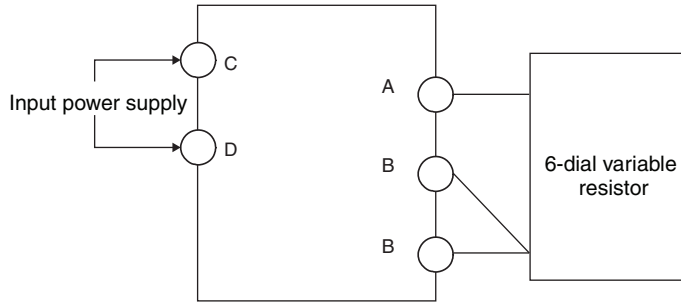

The terminal numbers are as follows:

- Input Terminals (A/B/B)
E5CD: 4, 5, and 6
E5ED: 22, 23, and 24

- Input Power Supply (C/D)
E5CD: 11 and 12
E5ED: 1 and 2

E5□D-B

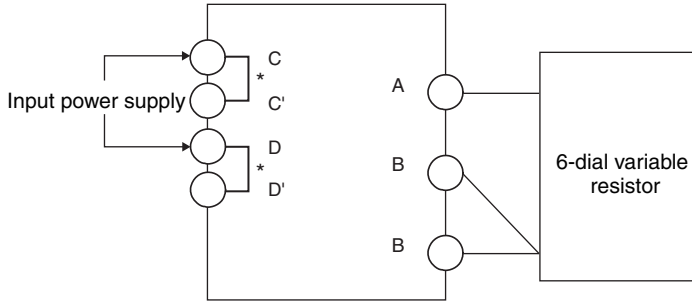

* Common terminals are indicated with asterisks (*).

The terminal numbers are as follows:

- Input Terminals (A/B/B)
E5CD-B: 6, 7, and 8
E5ED-B: 30, 31, and 32

- Input Power Supply (C or C', and D or D')
E5CD-B: 13 or 14, and 15 or 16
E5ED-B: 1 or 2, and 3 or 4

• Operation

Set the 6-dial variable resistor to the resistance that is equivalent to the test value.

● **Analog Input**

- Preparations

The diagram below shows the required device connections.
(The connection terminals depend on the model and input type.)

Current Input

E5□D

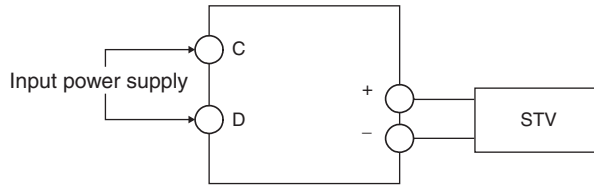

The terminal numbers are as follows:

- | | |
|--|-------------------------------|
| • Input Terminals
(Positive and Negative) | • Input Power Supply
(C/D) |
| E5CD: 4 and 5 | E5CD: 11 and 12 |
| E5ED: 22 and 23 | E5ED: 1 and 2 |

E5□D-B

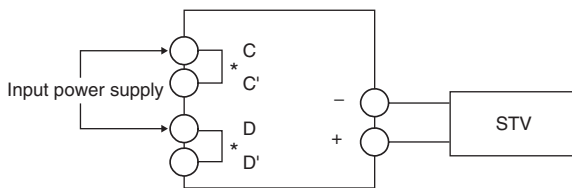

The terminal numbers are as follows:

- | | |
|--|--|
| • Input Terminals
(Positive and Negative) | • Input Power Supply
(C or C', and D or D') |
| E5CD-B: 6 and 7 | E5CD-B: 13 or 14, and 15 or 16 |
| E5ED-B: 30 and 31 | E5ED-B: 1 or 2, and 3 or 4 |

* Common terminals are indicated with asterisks (*).

Voltage Input

E5□D

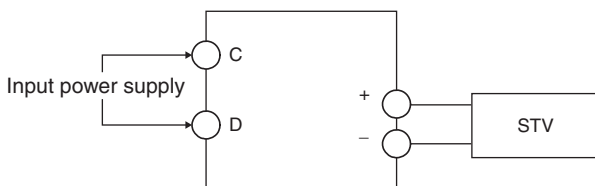

The terminal numbers are as follows:

- | | |
|--|-------------------------------|
| • Input Terminals
(Negative and Positive) | • Input Power Supply
(C/D) |
| E5CD: 5 and 6 | E5CD: 11 and 12 |
| E5ED: 23 and 24 | E5ED: 1 and 2 |

E5□D-B

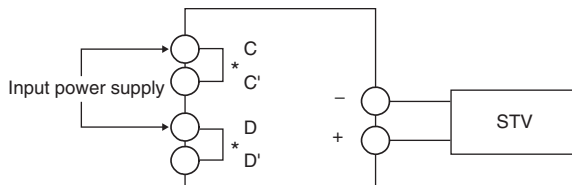

The terminal numbers are as follows:

- | | |
|--|--|
| • Input Terminals
(Negative and Positive) | • Input Power Supply
(C or C', and D or D') |
| E5CD-B: 7 and 8 | E5CD-B: 13 or 14, and 15 or 16 |
| E5ED-B: 31 and 32 | E5ED-B: 1 or 2, and 3 or 4 |

* Common terminals are indicated with asterisks (*).

- Operation

Set the STV output to the voltage or current test value.

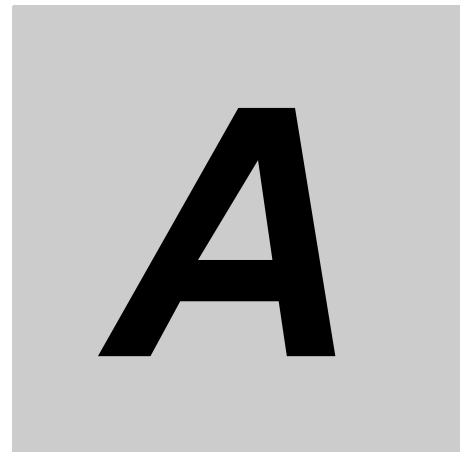

Appendices

A-1 Specifications	A-2
A-1-1 Ratings	A-2
A-1-2 Characteristics	A-4
A-1-3 Rating and Characteristics of Options	A-5
A-1-4 Waterproof Packing	A-5
A-1-5 Setup Tool Port Cover for Front Panel 000	A-6
A-1-6 Draw-out Jig	A-7
A-2 Current Transformer (CT)	A-8
A-2-1 Specifications	A-8
A-2-2 Dimensions (Unit: mm)	A-8
A-3 USB-Serial Conversion Cable and Conversion Cable 000	A-11
A-3-1 E58-CIFQ2 USB-Serial Conversion Cable	A-11
A-3-2 E58-CIFQ2-E Conversion Cable	A-12
A-4 Temperature Sensor for Packing Machines	A-13
A-4-1 Model Number Legend	A-13
A-4-2 Dimensions	A-14
A-4-3 Mounting Brackets	A-15
A-5 Error Displays	A-16
A-6 Troubleshooting	A-20
A-7 Parameter Operation Lists	A-23
A-7-1 Operation Level	A-23
A-7-2 Adjustment Level	A-24
A-7-3 Initial Setting Level	A-26
A-7-4 Manual Control Level	A-30
A-7-5 Monitor/Setting Item Level	A-30
A-7-6 Advanced Function Setting Level	A-30
A-7-7 Protect Level	A-35
A-7-8 Communications Setting Level	A-35
A-7-9 Initialization According to Parameter Changes	A-36
A-8 Sensor Input Setting Range, Indication Range, Control Range	A-39
A-9 Setting Levels Diagram	A-40
A-10 Parameter Flow 000	A-41
A-11 Parameter Flow (For E5□D-□-80□)	A-43

A-1 Specifications

A-1-1 Ratings

Supply voltage		100 to 240 VAC, 50/60 Hz	24 VAC, 50/60 Hz/24 VDC
Operating voltage range		85% to 110% of rated supply voltage	
Power consumption	E5CD or E5CD-B	Option number 000, 800: 5.2 VA max. Other option numbers: 6.5 VA max.	Option number 000, 800: 3.1 VA max./1.6 W max. Other option numbers: 4.1 VA max./2.3 W max.
	E5ED or E5ED-B	Option number 000, 800: 6.6 VA max. Other option numbers: 8.3 VA max.	Option number 000, 800: 4.1 VA max./2.3 W max. Other option numbers: 5.5 VA max./3.2 W max.
Sensor input ^{*1}		Thermocouple: K, J, T, E, L, U, N, R, S, B, C/W, PLII Platinum resistance thermometer: Pt100, JPt100 Infrared temperature sensor: 10 to 70°C, 60 to 120°C, 115 to 165°C, 140 to 260°C Current input ^{*2} : 4 to 20 mA, 0 to 20 mA (Input impedance: 150 Ω max.) Voltage input ^{*2} : 1 to 5 V, 0 to 5 V, 0 to 10 V ⁵ (Input impedance: 1 MΩ min.)	
Control output 1/2 ^{*3}	Relay output	E5CD or E5CD-B	SPST-NO, 250 VAC, 3 A (resistive load), electrical life: 100,000 operations Min. applicable load: 5 V, 10 mA (reference values)
		E5ED or E5ED-B	SPST-NO, 250 VAC, 5 A (resistive load), electrical life: 100,000 operations Min. applicable load: 5 V, 10 mA (reference values)
	Voltage output (for driving SSR)	E5CD or E5CD-B	Output voltage 12 VDC ±20% (PNP), max. load current 21 mA, with short-circuit protection circuit
		E5ED or E5ED-B	Output voltage 12 VDC ±20% (PNP), max. load current 40 mA, with short-circuit protection circuit (21 mA if there are two control outputs)
Linear current output		4 to 20 mA DC, 0 to 20 mA DC, Load: 500 Ω max. Resolution: Approx. 10,000	
Auxiliary output	Relay outputs	E5CD	2 auxiliary outputs SPST-NO, 250 VAC, 3 A (resistive load), Electrical life: 100,000 operations, Minimum applicable load: 10 mA at 5 V (reference values)
		E5CD-B	2 auxiliary outputs SPST-NO, 250 VAC, 2 A (resistive load), Electrical life: 100,000 operations, Minimum applicable load: 10 mA at 5 V (reference values)
		E5ED or E5ED-B	4 auxiliary outputs SPST-NO, 250 VAC, 2 A (resistive load), Electrical life: 100,000 operations, Minimum applicable load: 10 mA at 5 V (reference values)
Control method		ON/OFF or 2-PID control (with autotuning)	
Setting method		Digital setting using front panel keys	
Indication method		11-segment digital display, individual indicators, and bar display	
Other functions		Depend on the model	
Ambient temperature		-10 to 55°C (with no condensation or icing), For 3-year warranty: Mounted individually at -10 to 50°C (with no condensation or icing)	
Ambient humidity		25% to 85%	
Storage temperature		-25 to 65°C (with no condensation or icing)	
Altitude		2,000 m max.	
Recommended fuse		T2A, 250 VAC, time lag, low shut-off capacity	
Installation environment		Overvoltage Category II, Pollution Class 2 (EN/IEC/UL 61010-1)	

*1 For input setting ranges, refer to *A-8 Sensor Input Setting Range, Indication Range, Control Range*.

*2 When connecting the ES2-HB/THB, connect it 1:1.

*3 The E5CD or E5CD-B does not have control output 2.

● HB and HS Alarms

(E5□D Models with HB and HS Alarms)

Max. heater current	50 A AC
Input current readout accuracy	±5% FS ±1 digit max.
Heater burnout alarm setting range	0.1 to 49.9 A (0.1 A units) 0.0 A: Heater burnout alarm output turns OFF. 50.0 A: Heater burnout alarm output turns ON. Min. detection ON time ^{*1} : 30 ms for a control period of 0.1 s or 0.2 s 100 ms for a control period of 0.5 s or 1 to 99 s
Heater short alarm setting range	0.1 to 49.9 A (0.1 A units) 0.0 A: Heater short alarm output turns ON. 50.0 A: Heater short alarm output turns OFF. Min. detection OFF time ^{*2} : 38 ms for a control period of 0.1 s or 0.2 s 100 ms for a control period of 0.5 s or 1 to 99 s

*1 HB alarms are not detected and the heater power is not measured if the ON time for the control output for heating is 100 ms or less (30 ms or less if the control period is 0.1 or 0.2 s).

*2 HS alarms are not detected and the leakage power is not measured if the OFF time for the control output for heating is 100 ms or less (38 ms or less if the control period is 0.1 or 0.2 s).

A-1-2 Characteristics

Indication accuracy (when mounted individually, ambient temperature of 23°C)	Thermocouple ^{*1}	(±0.3% of indication value or ±1°C, whichever is greater) ±1 digit max.
	Resistance thermometer	(±0.2% of indication value or ±0.8°C, whichever is greater) ±1 digit max.
	Analog input	±0.2% FS ±1 digit max.
	CT input	±5% FS ±1 digit max.
Temperature variation influence ^{*2} Voltage variation influence ^{*2} Electromagnetic interference influence (according to EN 61326-1)	Thermocouple	Thermocouple (R, S, B, C/W, PLII) (±1% of indication value or ±10°C, whichever is greater) ±1 digit max. Other thermocouples: (±1% of indication value or ±4°C, whichever is greater) ±1 digit max. ^{*K} thermocouple at -100°C max: ±10°C max.
	Resistance thermometer	(±1% of indication value or ±2°C, whichever is greater) ±1 digit max.
	Analog input	±1% FS ±1 digit max.
	CT input	±5% FS ±1 digit max.
Hysteresis	Temperature input	0.1 to 999.9°C or °F (in units of 0.1°C or °F)
	Analog input	0.01% to 99.99% FS (in units of 0.01% FS)
Proportional band (P) Proportional band (P) for cooling	Temperature input	0.1 to 999.9°C or °F (in units of 0.1°C or °F)
	Analog input	0.1% to 999.9% FS (in units of 0.1% FS)
Integral time (I) ^{*3} Integral time (I) for cooling ^{*3}		Standard or heating/cooling control: 0 to 9,999 s (in 1-s increments) or 0.0 to 999.9 s (in 0.1-s increments)
Derivative time (D) ^{*3} Derivative time (D) for cooling ^{*3}		0 to 9,999 s (in units of 1 s) 0.0 to 999.9 s (in units of 0.1 s)
Control Period		0.1, 0.2, 0.5, or 1 to 99 s (in units of 1 s)
Adaptive control	SP response proportional band (P)	Temperature input: 0.1 to 999.9°C or °F (in units of 0.1°C or °F)
	SP response integral time (I)	0 to 9999 s (in units of 1 s), 0.0 to 999.9 s (in units of 0.1 s) ^{*3}
	SP response derivative time (D)	0 to 9999 s (in units of 1 s), 0.0 to 999.9 s (in units of 0.1 s) ^{*3}
	Disturbance response proportional band (P)	Temperature input: 0.1 to 999.9°C or °F (in units of 0.1°C or °F)
	Disturbance response integral time (I)	0 to 9999 s (in units of 1 s), 0.0 to 999.9 s (in units of 0.1 s) ^{*3}
	Disturbance response derivative time (D)	0 to 9999 s (in units of 1 s), 0.0 to 999.9 s (in units of 0.1 s) ^{*3}
Manual reset value		0.0% to 100.0% (in units of 0.1%)
Alarm setting range		-1,999 to 9,999 (except for MV alarm) Temperature input: The decimal point is automatically set when the sensor is selected. Analog input: The decimal point depends on the Decimal Point parameter setting. -199.9 to 999.9 (MV alarm)

Sampling cycle		50 ms		
Insulation resistance		20 MΩ min. (at 500 VDC)		
Dielectric strength		100 to 240 VAC: 3,000 VAC, 50/60 Hz for 1 min between terminals of different charge 24 VAC/DC: 3,000 VAC,* 50/60 Hz for 1 min between terminals of different charge		
Malfunction vibration		10 to 55 Hz, 20 m/s ² for 10 min each in X, Y and Z directions		
Vibration resistance		10 to 55 Hz, 20 m/s ² for 2 hr each in X, Y, and Z directions		
Malfunction shock		100 m/s ² , 3 times each in X, Y, and Z directions		
Shock resistance		300 m/s ² , 3 times each in X, Y, and Z directions		
Weight	E5CD	Approx. 120 g	Adapter: Approx. 10 g	Terminal cover: Approx. 0.5 g each
	E5ED	Approx. 210 g	Adapter: Approx. 4 g × 2	Terminal Cover: Approx. 1 g each
	E5CD-B	Approx. 120 g	Adapter: Approx. 10 g	---
	E5ED-B	Approx. 210 g	Adapter: Approx. 4 g × 2	---
Degree of protection		Front panel: IP66, rear case: IP20, terminals: IP00		
Memory protection		Non-volatile memory (number of writes: 1,000,000)		



- *1 The indication accuracy of K, T, and N thermocouples at a temperature of -100°C or less is ±2°C ±1 digit maximum. The indication accuracy of U and L thermocouples is ±2°C ±1 digit maximum. The indication accuracy of B thermocouples at a temperature of 400°C or less is not specified. The indication accuracy of B thermocouples at a temperature of 400 to 800°C is ±3°C maximum. The indication accuracy of R and S thermocouples at a temperature of 200°C or less is ±3°C ±1 digit maximum. The indication accuracy of C/W thermocouples is (±0.3% of PV or ±3°C, whichever is greater) ±1 digit maximum. The indication accuracy of PLII thermocouples is (±0.3% of PV or ±2°C, whichever is greater) ±1 digit maximum.
- *2 Ambient temperature: -10°C to 23°C to 55°C
Voltage range: -15 to +10% of rated voltage
- *3 The unit is determined by the setting of the Integral/Derivative Time Unit parameter.

A-1-3 Rating and Characteristics of Options

Event inputs	Contact Input ON: 1 kΩ max., OFF: 100 kΩ min.
	Non-contact Input ON: Residual voltage 1.5 V max.; OFF: Leakage current 0.1 mA max.
Communications	Transmission path: RS-485: Multidrop
	Communications method: RS-485 (2-wire, half duplex)
	Synchronization: Start-stop
	Protocol: CompoWay/F or Modbus
Transfer output	Baud rate: 9.6, 19.2, 38.4, 57.6, or 115.2 kbps
	Current output: 4 to 20 mA DC, Load: 500 Ω max., Resolution: 10,000, Accuracy: ±0.3% FS Linear voltage output: 1 to 5 VDC, Load: 1 kΩ min., Resolution: 10,000, Accuracy: ±0.3% FS

A-1-4 Waterproof Packing

If the Waterproof Packing is lost or damaged, order one of the following models.

Y92S-P8 (for DIN 48 × 48)	Y92S-P9 (for DIN 48 × 96)
	

A-1-5 Setup Tool Port Cover for Front Panel 000

A Y92S-P7 Setup Tool Port Cover for the front panel is included with the E5ED or E5ED-B. Order this Port Cover separately if the Port Cover on the front-panel Setup Tool port is lost or damaged. The Waterproof Packing must be periodically replaced because it may deteriorate, shrink, or harden depending on the operating environment.

Y92S-P7



Use the following procedure to replace the Setup Tool Port Cover for the front panel.

● **Replacement Procedure**

<p>1 Open the Setup Tool Port Cover on the front panel.</p>	
<p>2 Pull gently on the Setup Tool Port Cover to remove it from the Digital Controller.</p>	
<p>3 Insert the stopper on the Setup Tool Port Cover into the hole at the bottom of the port.</p>	
<p>4 Make sure that the Setup Tool Port Cover is closed.</p>	

A-1-6 Draw-out Jig

You can use a Draw-out Jig to remove the interior body of the Digital Controller from the case to perform maintenance without removing the terminal leads. Refer to *2-1-4 Drawing Out the Interior Body of the Digital Controller to Replace It* for the application method.

● Y92F-58 (for E5CD)

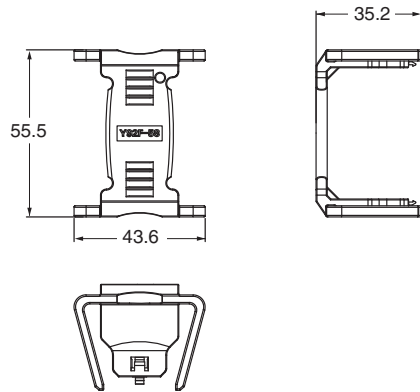

● Y92F-59 (for E5ED)

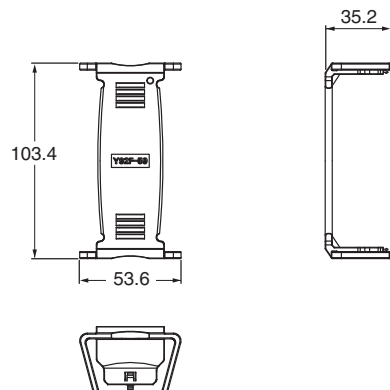

A-2 Current Transformer (CT)

A-2-1 Specifications

Item	Specifications			
	E54-CT1	E54-CT3	E54-CT1L	E54-CT3L
Model number	E54-CT1	E54-CT3	E54-CT1L	E54-CT3L
Max. continuous current	50 A AC	120 A AC *1	50 A AC	120 A AC*1
Dielectric strength	1,000 VAC (for 1 min)		1,500 VAC (1 min)	
Vibration resistance	50 Hz, 98 m/s ²			
Weight	Approx. 11.5 g	Approx. 50 g	Approx. 14 g	Approx. 57 g
Accessories	None	Armature (2), Plug (2)	None	None

*1 The maximum continuous current of the E5□D is 50 A.

A-2-2 Dimensions (Unit: mm)

- E54-CT1

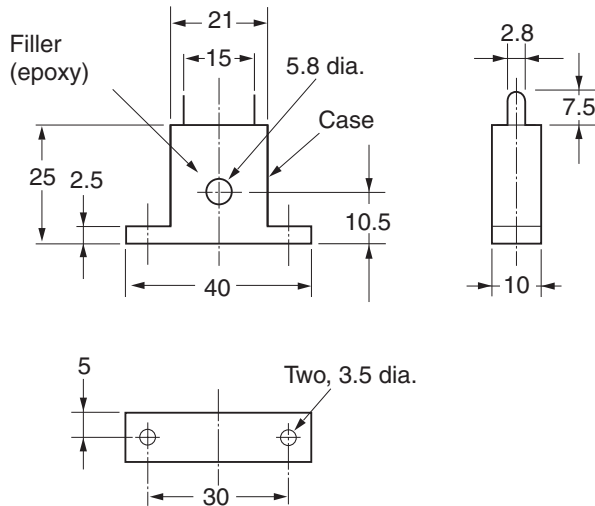

• E54-CT1L

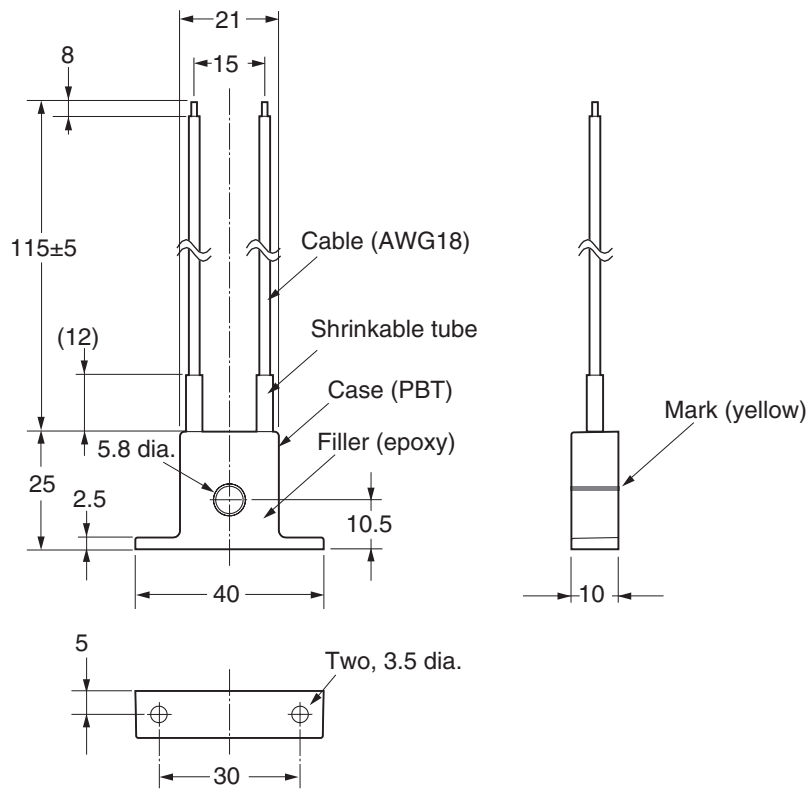

• E54-CT3

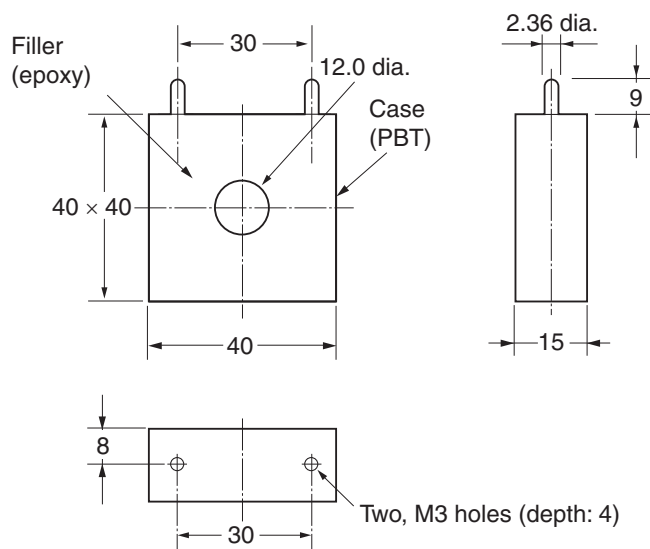

• E54-CT3L

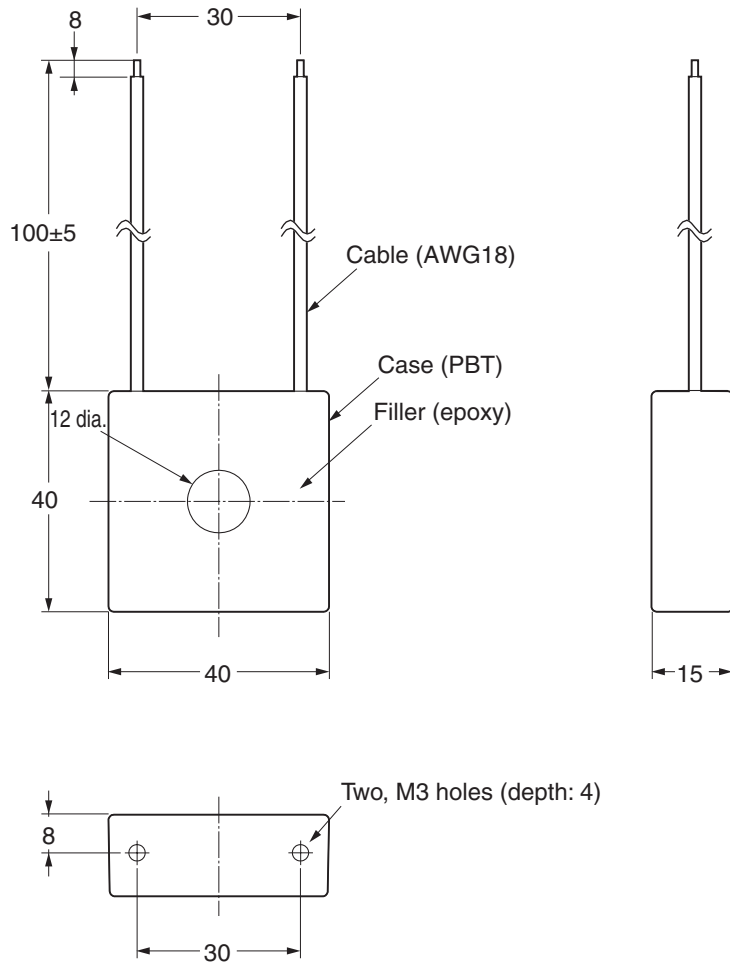

A-3 USB-Serial Conversion Cable and Conversion Cable 000

A USB-Serial Conversion Cable is used to connect the E5□D to a computer. The E58-CIFQ2-E Conversion Cable is also required to connect to the Setup Tool port on the front panel of the E5ED or E5ED-B. The following table lists the cables and ports that are used.

Connection port	Cable
Setup Tool port (card edge type)	E58-CIFQ2 USB-Serial Conversion Cable
Setup Tool port (pin jack)	E58-CIFQ2 USB-Serial Conversion Cable and E58-CIFQ2-E Conversion Cable

Refer to 2-5 *Using the Setup Tool Port* for the connection procedure.

A-3-1 E58-CIFQ2 USB-Serial Conversion Cable

● Specifications

Item	Specifications
Applicable OS	Windows XP, Vista, 7, 8, or 10 ^{*2}
Applicable software	E5CD/E5ED: CX-Thermo Ver, 4.66 or higher E5CD-B/E5ED-B: CX-Thermo Ver, 4.67 or higher
Applicable models	E5CB Series, E5□C Series, E5□C-T Series, and E5□D Series
USB interface rating	Conforms to USB Specification 2.0
DTE speed	38,400 bps
Connector specifications	Computer end: USB (type A plug) Digital Controller: Special serial connector
Power supply	Bus power (Supplied from USB host controller) ^{*1}
Power supply voltage	5 VDC
Current consumption	450 mA max.
Output voltage	4.7±0.2 VDC (Supplied through USB-Serial Conversion Cable to the Digital Controller.)
Output current	250 mA max. (Supplied through USB-Serial Conversion Cable to the Digital Controller.)
Ambient temperature	0 to 55°C (with no condensation or icing)
Ambient humidity	10% to 80%
Storage temperature	-20 to 60°C (with no condensation or icing)
Storage humidity	10% to 80%
Altitude	2,000 m max.
Weight	Approx. 120 g

Windows is a registered trademark of Microsoft Corporation in the United States and other countries.

*1 Use a high-power port for the USB port.

*2 CX-Thermo version 4.65 or higher runs on Windows 10.

● **Dimensions**

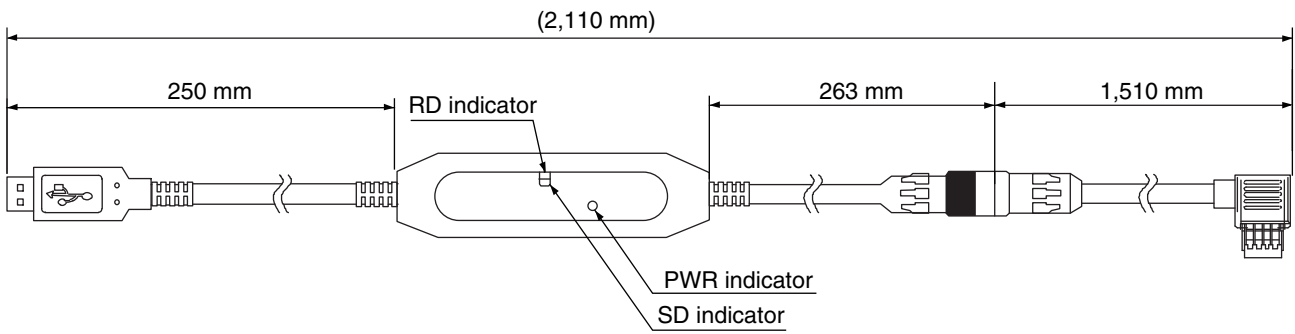

LED Indicator Display

Indicator	Color	Status	Meaning
PWR	Green	Lit.	USB bus power is being supplied.
		Not lit.	USB bus power is not being supplied.
SD	Yellow	Lit	Sending data from USB-Serial Conversion Cable
		Not lit	Not sending data from USB-Serial Conversion Cable
RD	Yellow	Lit	Receiving data from the USB-Serial Conversion Cable
		Not lit	Not receiving data from the USB-Serial Conversion Cable

A-3-2 E58-CIFQ2-E Conversion Cable

● **Specifications**

Item	Specification
Applicable models	E5EC/E5EC-B/E5AC/E5DC/E5GC Series, E5EC-T/E5AC-T Series, and E5ED/E5ED-B
Connector specifications	Digital Controller: 4-pin plug E58-CIFQ2: Small special connector
Ambient temperature	0 to 55°C (with no condensation or icing)
Ambient humidity	10% to 80%
Storage temperature	-20 to 60°C (with no condensation or icing)
Storage humidity	10% to 80%
Altitude	2,000 m max.
Weight	Approx. 60 g

● **Dimensions**

E58-CIFQ2-E Conversion Cable

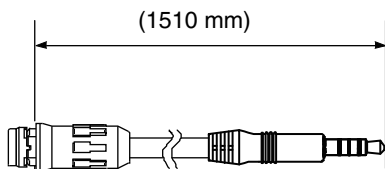

Note: Always use the E58-CIFQ2-E together with the E58-CIFQ2.

Connected to the E58-CIFQ2 USB-Serial Conversion Cable

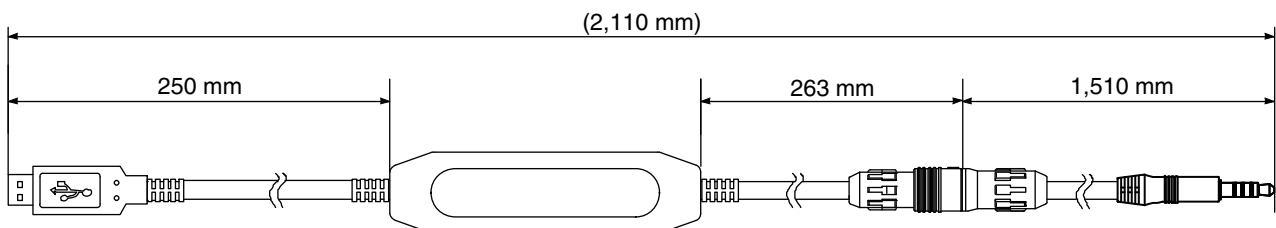

A-4 Temperature Sensor for Packing Machines

Type	Name	Model number and appearance	Temperature range	Element type	Method	Class	Protective material	Terminal form
Specialized Type for Packaging Machines	Sheathed Thermocouple	E52-CA□□A□ D=1□S□ 	0 to 650°C	K(CA)	Grounded	Class2 (0.75)	ASTM316 L	Prewired lead wires

A-4-1 Model Number Legend

The protective tubing length and lead length can be specified as shown below. Use the model number legend to specify the model and inquire about delivery times and prices.

E 52 - CA □ □ A □ D = 1 S □ □ □ M

Code	Element type
CA	K

Protective tubing length L (cm)
Specify the tubing length in centimeters.
The following range of lengths is available.

Diameter D	Length L (cm)
1.0	6
1.0	12
1.0	3 to 100 (in centimeters, variable)

Code	Terminal type
A	Exposed lead wires

Code	Terminal processing
Y	Y-type crimp terminals for M3.0
F	Ferrules

Code	Protective tubing diameter D	Protective tubing structure
D=1	1 mm	Sheathed

Code	Application
S	Temperature Sensor for Packing Machines

Code	Compensating conductor
1	Heat resistant (7 cores)
2	Flexible and heat resistant (30 cores)

Lead wire length M (m)
Specify the M length in meters.
Range: 0.5, 1, 2, or 0.5 to 12 (in meters, variable)

Example:

Element: K, protective tube length: 12 cm, exposed lead wires, Y-type crimp terminals for M3.0, protective tubing diameter: 1 cm, flexible and heat resistant, lead wire length: 2 m

E52-CA12AY D=1 S2 2M

A-4-2 Dimensions

● Y-type crimp terminals for M3.0

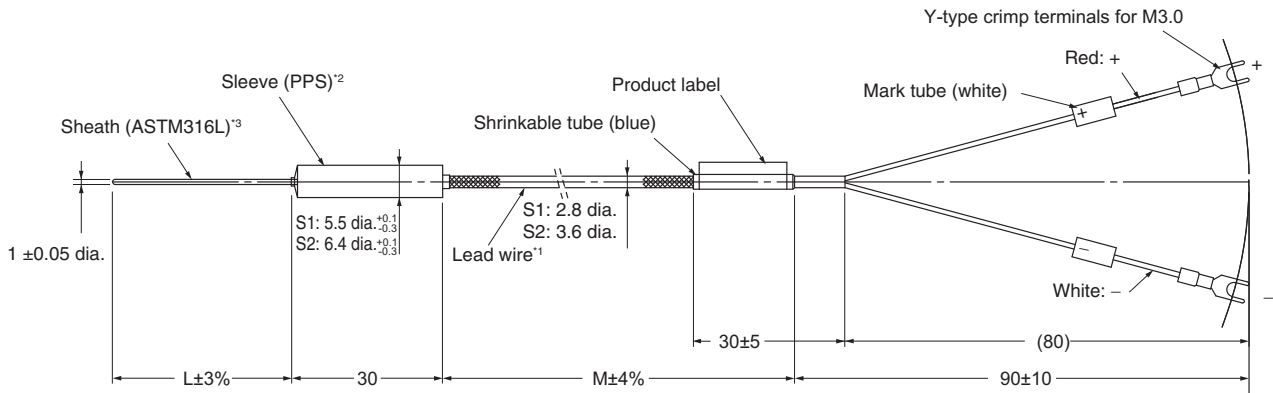

● Ferrules

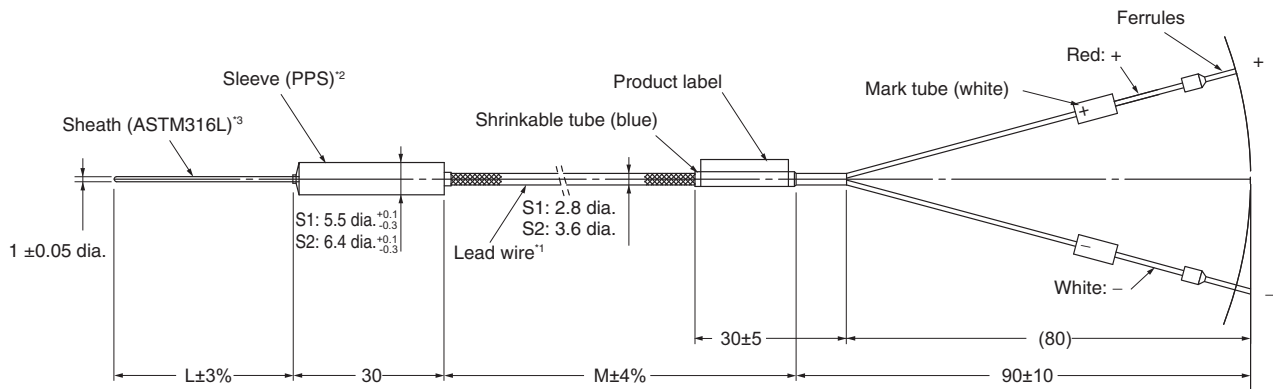

- *1 Lead wires (compensating wires) (excluding Y-type crimp terminals and ferrules)
Heat-resistance model (0 to 200°C): PFA glass-wool sheath with stainless outer shield
Flexible, heat-resistance model (0 to 200°C): PFA glass-wool sheath with stainless outer shield
- *2 Temperature range of sleeve: 0 to 260°C
- *3 The sheath can be easily bent. Performance will not be adversely affected even if the sheath is bent somewhat.
Do not bend the sheath beyond the following values.
Minimum bending radius: 2 mm
Bendable section: 8 mm or father from the end

A-4-3 Mounting Brackets

Use the following brackets or the equivalent to mount a Temperature Sensor for Packaging Machines to a hot plate.

Mounting bracket	Application	Manufacturer	Model number
(1)	1-mm-dia. protective tube bracket	Misumi Corporation	Square Shims ASFCS-series
(2)	Sleeve bracket (S1)	Misumi Corporation	Cable Clips COPU3-20P
		Digi-Key	Cable Clamp RPC1156-ND
	Sleeve bracket (S2)	Misumi Corporation	Cable Clips COPU4-20P
		Digi-Key	Cable Clamp RPC1474-ND

Note: All of the above mounting brackets are SUS304.

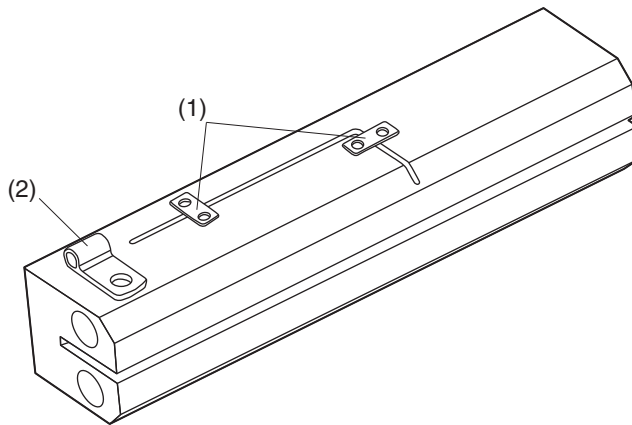

A-5 Error Displays

When an error occurs, the error contents are shown on the No. 1 or the No. 2 display. This section describes how to check error codes on the display, and the actions to be taken to remedy the problems.

S.ERR Input Error

● Meaning

The input value has exceeded the control range. *

The input type setting is not correct.

The sensor is disconnected or shorted.

The sensor wiring is not correct.

The sensor is not wired.

* Control Range

Resistance thermometer, thermocouple input:	Temperature setting lower limit -20°C to temperature setting upper limit $+20^{\circ}\text{C}$ (Temperature setting lower limit -40°F to temperature setting upper limit $+40^{\circ}\text{F}$)
ES1B input:	Same as input indication range
Analog input:	-5% to $+105\%$ of scaling range

● Action

Check the wiring of inputs for miswiring, disconnections, and short-circuits and check the input type.

If no abnormality is found in the wiring and input type, turn the power OFF then back ON again.

If the display remains the same, the Digital Controller must be replaced. If the display is restored, then the probable cause is electrical noise affecting the control system. Check for electrical noise.

Note: With resistance thermometer input, a break in the A, B, or B line is regarded as a disconnection.

● Operation

After an error occurs, the error is displayed and the alarm outputs function as if the upper limit has been exceeded.

It will also operate as if transfer output exceeded the upper limit. If an input error is assigned to a control output or auxiliary output, the output will turn ON when the input error occurs.

If an input error is assigned to a control output or auxiliary output, the output will turn ON when the input error occurs. The error message will appear in the display for the PV.

Note: The heating and cooling control outputs will turn OFF. When the manual MV, MV at stop, or MV at error is set, the control output is determined by the set value.

cccc
 Display Range Exceeded
 9999

● **Meaning**

Though this is not an error, it is displayed if the process value exceeds the display range when the control range is larger than the display range.

The display ranges are shown below (with decimal points omitted).

- When less than -1,999: ccccc
- When more than 9,999: 9999

● **Operation**

Control continues, allowing normal operation. The value will appear in the display for the PV.

Resistance thermometer input (Except for models with a setting range of -199.9 to 500.0°C)
 Thermocouple input (Except for models with a setting range of -199.9 to 400.0°C)
 ES1B

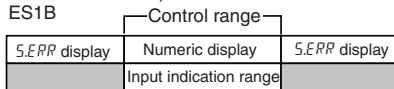

Analog Input
 • When display range < control range

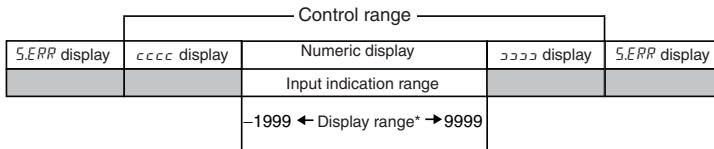

Resistance thermometer input (Except for models with a setting range of -1999. to 500.0°C)
 Thermocouple input (Except for models with a setting range of -199.9 to 400.0°C)

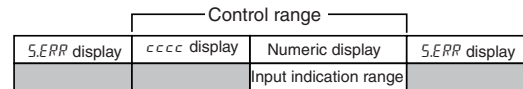

Analog Input
 • When display range ≥ control range

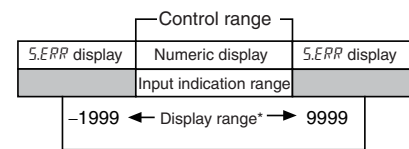

*The display range is shown in numbers with decimal points omitted.

E333 AD Converter Error

● **Meaning**

There is an error in internal circuits.

● **Action**

First, turn the power OFF then back ON again. If the display remains the same, the Digital Controller must be repaired. If the display is restored, then the probable cause is electrical noise affecting the control system. Check for electrical noise.

● **Operation**

The control, auxiliary, and transfer outputs turn OFF. (A linear current output will be approx. 0 mA.)

E111 Memory Error

- **Meaning**

Internal memory operation is in error.

- **Action**

First, turn the power OFF then back ON again. If the display remains the same, the Digital Controller must be repaired. If the display is restored, then the probable cause is electrical noise affecting the control system. Check for electrical noise.

- **Operation**

The control, auxiliary, and transfer outputs turn OFF. (A linear current output will be approx. 0 mA.)

FFFF Current Value Exceeds

- **Meaning**

This error is displayed when the heater current value exceeds 55.0 A.

- **Operation**

Control continues, allowing normal operation. An error message is displayed when the following items are displayed.

Heater current 1 value monitor
Leakage current 1 monitor

EE1 HB Alarm
LE1 HS Alarm

- **Meaning**

If there is an HB or HS alarm, the relevant parameter will flash on the No. 1 display.

- **Operation**

The relevant Heater Current 1 Value Monitor or Leakage Current 1 Monitor parameters in the Operation or Adjustment Level will flash on the No. 1 display. However, control continues and operation is normal.

---- Ambient Temperature Monitor Out of Range

● **Meaning**

If the temperature is out of range for the Ambient Temperature Monitor parameter, ---- is displayed.

- If the temperature unit is °C, this error occurs when the ambient temperature is less than -30°C or greater than 75°C.
- If the temperature unit is °F, this error occurs when the ambient temperature is less than 10°F or greater than 171°F.

● **Action**

Make sure that the ambient temperature of the Digital Controller is within the rated range.

- The Controller is subjected to heat radiated from heating equipment.
- The Controller is subjected to direct sunlight.
- The Controller is subjected to icing or condensation.

● **Operation**

Control continues and operation is normal.

A-6 Troubleshooting

Checking Problems

If the Digital Controller is not operating normally, check the following points before requesting repairs. If the problem persists, contact your OMRON representative for details on returning the product.

Timing	Status	Meaning	Countermeasures	Page
Turning ON the power for the first time	Temperature error is large. Input error (S.Err display)	Input type mismatch	Check the sensor type and reset the input type correctly.	4-12
		Thermometer is not installed properly.	Check the thermometer installation location and polarity and install correctly.	2-10, 2-18
	Communications are not possible.	Non-recommended adapter is being used.	Make sure that the connected device is not faulty.	*
During operation	Overshooting Undershooting Hunting	ON/OFF control is enabled (default: ON/OFF control selected).	Select PID control and perform auto-tuning.	4-24
		Control period is longer compared with the speed of rise and fall in temperature.	Shorten the control period. A shorter control period improves control performance, but a cycle of 20 ms minimum is recommended in consideration of the service life of the relays.	4-15
		Unsuitable PID constant	Set appropriate PID constants using either of the following methods. <ul style="list-style-type: none"> Execute AT (autotuning). Set PID constants individually using manual settings. 	4-24
		HS alarm operation fault	Use breeder resistance if the problem is due to leakage current. Also investigate the errors detected by the HS alarm function.	4-41
		The power supply to the load (e.g., heater) was turned ON or OFF during tuning.	During tuning,* ensure that the power for the load (e.g., heater) is ON. Otherwise, the correct tuning result cannot be calculated and optimal control will not be possible. * "Tuning" refers to the following functions: AT, adaptive control, automatic filter adjustment, and water-cooling output adjustment.	
	Temperature is not rising	Specified operation is unsuitable for required control (default: Reverse operation).	Select either forward or reverse operation depending on the required control. Reverse operation is used for heating operations.	4-15
		Heater is burnt out or deteriorated.	Check whether heater burnout or deterioration have occurred. Also investigate the errors detected by the heater burnout alarm.	4-38
		Insufficient heater capacity	Check whether the heater's heating capacity is sufficient.	---
		Cooling system in operation.	Check whether a cooling system is operating.	---
		Peripheral devices have heat prevention device operating.	Set the heating prevention temperature setting to a value higher than the set temperature of the Digital Controller.	---
	The AT Execute/Cancel parameter (Rt) is not displayed.	ON/OFF control is enabled.	Set the PID ON/OFF parameter to PID.	6-43
		The Controller is stopped.	Set the RUN/STOP parameter to RUN.	6-12
	The Alarm 1 Type parameter (Rt l) is not displayed.	The Auxiliary Output 1 Assignment parameter is set to a heater alarm for a Controller with heater burnout detection.	Set the Auxiliary Output 1 Assignment parameter to Alarm 1. The default setting is for a heater alarm (HA).	6-82

* Refer to the *E5-D Digital Controllers Communications Manual* (Cat. No. H225) for details.

Timing	Status	Meaning	Countermeasures	Page
During operation (continued)	Output will not turn ON	Set to STOP (default: RUN)	Set the RUN/STOP mode to RUN. If STOP is lit on the display, control is stopped.	5-36
		Specified operation is unsuitable for required control (default: Reverse operation).	Select either forward or reverse operation depending on the required control. Reverse operation is used for heating operations.	4-15
		A high hysteresis is set for ON/OFF operation (default: 1.0°C)	Set a suitable value for the hysteresis.	4-21
		The specified power is not being supplied from the terminals.	The output will not turn ON while the Digital Controller is being operated with power supplied through the USB-Serial Conversion Cable. Supply the specified power from the terminals.	---
	Digital Controller will not operate	Set to STOP (default: RUN)	Set the RUN/STOP mode to RUN. If STOP is lit on the display, control is stopped.	5-36
	Temperature error is large Input error (S.err display)	Thermometer has burnt out or short-circuited.	Check whether the thermometer has burnt out or short-circuited.	---
		Thermometer lead wires and power lines are in the same conduit, causing noise from the power lines (generally, display values will be unstable).	Wire the lead wires and power lines in separate conduits, or wire them using a more direct path.	---
		Connection between the Digital Controller and thermocouple is using copper wires.	Connect the thermocouple's lead wires directly, or connect compensating conductors that are suitable for the thermocouple.	---
		Installation location of thermometer is unsuitable.	Make sure that the location that is being measured with the temperature sensor is suitable.	---
		Input shift is not set correctly (default: 0.0°C)	Set a suitable input shift. If input shift is not required, set the input shift value to 0.0.	5-25
Keys will not operate	Setting change protect is ON.	Turn OFF setting change protect.	5-43	
Cannot shift levels	Operations limited due to protection.	Set the operation/adjustment protect, initial setting/communications protect, and setting change protect values as required.	5-44	
After long service life	Control is unstable	Terminal screws may be loose.	Retighten terminal screws to a torque of 0.43 to 0.58 N·m.	2-25
		The internal components have reached the end of their service life.	The Digital Controller's internal electrolytic capacitor depends on the ambient temperature, and load rate. The structural life depends on the ambient environment (shock, vibration). The life expectancy of the output relays varies greatly with the switching capacity and other switching conditions. Always use the output relays within their rated load and electrical life expectancy. If an output relay is used beyond its life expectancy, its contacts may become welded or burned. Replace the Digital Controller and all other Digital Controllers purchased in the same time period.	---

Symptom: Cannot Communicate or a Communications Error Occurs

Meaning	Countermeasures
The communications wiring is not correct.	Correct the wiring.
The communications line has become disconnected.	Connect the communications line securely and tighten the screws.
The communications cable is broken.	Replace the cable.
The communications cable is too long.	The total cable length for RS-485 is 500 m max.
The wrong communications cable has been used.	Use shielded twisted-pair cable for the communications cable. For detailed wire specifications, refer to <i>2-2-5 Precautions when Wiring</i> .
More than the specified number of communications devices are connected to the same communications path.	When 1:N communications are used, a maximum of 32 nodes may be connected, including the host node.
An end node has not been set at each end of the communications line.	Set or connect terminating resistance at each end of the line. If the E5□D is the end node, 120-Ω (1/2-W) terminating resistance is used. Be sure that the combined resistance with the host device is 54 Ω minimum.
The specified power supply voltage is not being supplied to the Digital Controller.	Supply the specified power supply voltage.
The specified power supply voltage is not being supplied to an Interface Converter (such as the K3SC).	Supply the specified power supply voltage.
The same baud rate and communications method are not being used by all of the Digital Controllers, host devices, and other devices on the same communications line.	Set the same values for the baud rate, protocol, data length, stop bits, and parity on all nodes.
The unit number specified in the command frame is different from the unit number set by the Digital Controller.	Use the same unit number.
The same unit number as the Digital Controller is being used for another node on the same communications line.	Set each unit number for only one node.
There is a mistake in programming the host device.	Use a line monitor to check the commands. Check operation using a sample program.
The host device is detecting the absence of a response as an error before it receives the response from the Digital Controller.	Shorten the send data wait time in the Digital Controller or increase the response wait time in the host device.
The host device is detecting the absence of a response as an error after broadcasting a command.	The Digital Controller does not return responses for broadcast commands.
The host device sent another command before receiving a response from the Digital Controller.	The response must always be read after sending a command (except for broadcast commands).
The host device sent the next command too soon after receiving a response from the Digital Controller.	After receiving a response, wait at least 2 ms before sending the next command.
The communications line became unstable when Digital Controller power was turned ON or interrupted, and the host device read the unstable status as data.	Initialize the reception buffer in the host device before sending the first command and after turning OFF the power to the Digital Controller.
The communications data was corrupted from noise from the environment.	Try using a slower baud rate. Separate the communications cable from the source of noise. Use a shielded, twisted-pair cable for the communications cable. Use as short a communications cable as possible, and do not lay or loop extra cable. To prevent inductive noise, do not run the communications cable parallel to a power line. If noise countermeasures are difficult to implement, use an Optical Interface.

* Refer to the *E5□D Digital Controllers Communications Manual* (Cat. No. H225) for details on errors.

A-7 Parameter Operation Lists

A-7-1 Operation Level

Parameters	Characters	Setting (monitor) value	Display	Default	Unit
Process Value		Temperature: According to indication range for each sensor. Analog: Scaling lower limit -5% FS to Scaling upper limit +5% FS			EU
Set Point		SP lower limit to SP upper limit		0	EU
Multi-SP Set Point Selection	<i>M-SP</i>	0 to 7		0	None
Set Point During SP Ramp	<i>SP-M</i>	SP lower limit to SP upper limit			EU
Heater Current 1 Value Monitor	<i>EL1</i>	0.0 to 55.0			A
Leakage Current 1 Monitor	<i>LEP1</i>	0.0 to 55.0			A
Program Start	<i>PRST</i>	RSET, STRT	<i>RSET, STRT</i>	RSET	None
Soak Time Remain	<i>SKTR</i>	0 to 9999			s, min, or h
RUN/STOP	<i>R-S</i>	RUN/STOP	<i>RUN, STOP</i>	Run	None
Alarm Value 1	<i>AL-1</i>	All alarms except for MV absolute-value upper-limit or lower-limit alarms: -1,999 to 9,999		0	EU
		MV absolute-value upper-limit or lower-limit alarms: -199.9 to 999.9		0.0	%
Alarm Value Upper Limit 1	<i>AL1H</i>	-1,999 to 9,999		0	EU
Alarm Value Lower Limit 1	<i>AL1L</i>	-1,999 to 9,999		0	EU
Alarm Value 2	<i>AL-2</i>	All alarms except for MV absolute-value upper-limit or lower-limit alarms: -1,999 to 9,999		0	EU
		MV absolute-value upper-limit or lower-limit alarms: -199.9 to 999.9		0.0	%
Alarm Value Upper Limit 2	<i>AL2H</i>	-1,999 to 9,999		0	EU
Alarm Value Lower Limit 2	<i>AL2L</i>	-1,999 to 9,999		0	EU
Alarm Value 3	<i>AL-3</i>	All alarms except for MV absolute-value upper-limit or lower-limit alarms: -1,999 to 9,999		0	EU
		MV absolute-value upper-limit or lower-limit alarms: -199.9 to 999.9		0.0	%
Alarm Value Upper Limit 3	<i>AL3H</i>	-1,999 to 9,999		0	EU
Alarm Value Lower Limit 3	<i>AL3L</i>	-1,999 to 9,999		0	EU
Alarm Value 4	<i>AL-4</i>	All alarms except for MV absolute-value upper-limit or lower-limit alarms: -1,999 to 9,999		0	EU
		MV absolute-value upper-limit or lower-limit alarms: -199.9 to 999.9		0.0	%
Alarm Value Upper Limit 4	<i>AL4H</i>	-1,999 to 9,999		0	EU
Alarm Value Lower Limit 4	<i>AL4L</i>	-1,999 to 9,999		0	EU
MV Monitor (Heating)	<i>ā</i>	-5.0 to 105.5 (standard) 0.0 to 105.0 (heating/cooling)			%
MV Monitor (Cooling)	<i>ē-ā</i>	0.0 to 105.0			%

A-7-2 Adjustment Level

Parameters	Characters	Setting (monitor) value	Display	Default	Unit
Adjustment Level Display	<i>LAdj</i>				
AT Execute/Cancel	<i>At</i>	OFF, AT Cancel AT-2: 100%AT Execute AT-1: 40%AT Execute ^{*1}	<i>OFF, At-2, At-1</i>	OFF	None
Communications Writing	<i>CMWt</i>	OFF, ON	<i>OFF, ON</i>	OFF	None
Heater Current 1 Value Monitor	<i>Et 1</i>	0.0 to 55.0			A
Heater Burnout Detection 1	<i>Hb 1</i>	0.0 to 50.0		0.0	A
Leakage Current 1 Monitor	<i>LCR 1</i>	0.0 to 55.0			A
HS Alarm 1	<i>HS 1</i>	0.0 to 50.0		50.0	A
SP 0	<i>SP-0</i>	SP lower limit to SP upper limit		0	EU
SP 1	<i>SP-1</i>	SP lower limit to SP upper limit		0	EU
SP 2	<i>SP-2</i>	SP lower limit to SP upper limit		0	EU
SP 3	<i>SP-3</i>	SP lower limit to SP upper limit		0	EU
SP 4	<i>SP-4</i>	SP lower limit to SP upper limit		0	EU
SP 5	<i>SP-5</i>	SP lower limit to SP upper limit		0	EU
SP 6	<i>SP-6</i>	SP lower limit to SP upper limit		0	EU
SP 7	<i>SP-7</i>	SP lower limit to SP upper limit		0	EU
Process Value Input Shift	<i>INS</i>	Temperature input: -199.9 to 999.9		0.0	°C or °F
		Analog input: -1,999 to 9,999		0	EU
Process Value Slope Coefficient	<i>INRt</i>	0.001 to 9.999		1.000	None
Automatic Filter Adjustment	<i>FA</i>	OFF, ON	<i>OFF, ON</i>	OFF	None
Input Digital Filter	<i>INF</i>	0.0 to 999.9		0.0	Seconds
PID Update (Adaptive Control)	<i>A-Ud</i>	OFF, ON	<i>OFF, ON</i>	OFF	None
Water-cooling Output Adjustment	<i>W-Ht</i>	OFF, ON	<i>OFF, ON</i>	OFF	None
Water-cooling Proportional Band Increase Threshold	<i>W-L</i>	Water-cooling proportional band decrease threshold + 0.1 to 200.0		1.4	°C or °F
Water-cooling Proportional Band Decrease Threshold	<i>W-dL</i>	0 to Water-cooling proportional band increase threshold - 0.1		0.6	°C or °F
Proportional Band	<i>P</i>	Temperature input: 0.1 to 999.9		8.0	°C
				14.4	°F
		Analog input: 0.1 to 999.9		10.0	%FS
Integral Time	<i>I</i>	Integral/Derivative Time Unit of 1 s: 0 to 9,999		233	Seconds
		Integral/Derivative Time Unit of 0.1 s: 0.0 to 999.9		233.0	
Derivative Time	<i>d</i>	Integral/Derivative Time Unit of 1 s: 0 to 9,999		40	Seconds
		Integral/Derivative Time Unit of 0.1 s: 0.0 to 999.9		40.0	
Proportional Band (Cooling)	<i>I-P</i>	Temperature input: 0.1 to 999.9		8.0	°C
				14.4	°F
		Analog input: 0.1 to 999.9		10.0	%FS
Integral Time (Cooling)	<i>I-I</i>	Integral/Derivative Time Unit of 1 s: 0 to 9,999		233	Seconds
		Integral/Derivative Time Unit of 0.1 s: 0.0 to 999.9		233.0	
Derivative Time (Cooling)	<i>I-d</i>	Integral/Derivative Time Unit of 1 s: 0 to 9,999		40	Seconds
		Integral/Derivative Time Unit of 0.1 s: 0.0 to 999.9		40.0	
SP Response Proportional Band	<i>SP-P</i>	0.1 to 999.9		8.0	°C
				14.4	°F
SP Response Integral Time	<i>SP-I</i>	Integral/Derivative Time Unit of 1 s: 0 to 9,999		233	Seconds
		Integral/Derivative Time Unit of 0.1 s: 0.0 to 999.9		233.0	

Parameters	Characters	Setting (monitor) value	Display	Default	Unit
SP Response Derivative Time	SP-d	Integral/Derivative Time Unit of 1 s: 0 to 9,999		40	Seconds
		Integral/Derivative Time Unit of 0.1 s: 0.0 to 999.9		40.0	
SP Response Coefficient Number	SP-N	0 to 9999		0	None
Disturbance Proportional Band	d-P	0.1 to 999.9		8.0	°C
				14.4	°F
Disturbance Integral Time	d-I	Integral/Derivative Time Unit of 1 s: 0 to 9,999		233	Seconds
		Integral/Derivative Time Unit of 0.1 s: 0.0 to 999.9		233.0	
Disturbance Derivative Time	d-d	Integral/Derivative Time Unit of 1 s: 0 to 9,999		40	Seconds
		Integral/Derivative Time Unit of 0.1 s: 0.0 to 999.9		40.0	
Dead Band	I-db	Temperature input: -199.9 to 999.9		0.0	°C or °F
		Analog input: -19.99 to 99.99		0.00	%FS
Manual Reset Value	MF-R	0.0 to 100.0		50.0	%
Hysteresis (Heating)	HYS	Temperature input: 0.1 to 999.9		1.0	°C
				1.8	°F
		Analog input: 0.01 to 99.99		0.10	%FS
Hysteresis (Cooling)	[HYS	Temperature input: 0.1 to 999.9		1.0	°C
				1.8	°F
		Analog input: 0.01 to 99.99		0.10	%FS
Soak Time	SOAK	1 to 9999		1	min, h, or s
Wait Band	WE-b	Temperature input: OFF or 0.1 to 999.9	OFF, 0.1 to 999.9	OFF	°C or °F
		Analog input: OFF, 0.01 to 99.99	OFF, 0.01 to 99.99	OFF	%FS
MV at Stop	MV-S	Standard: -5.0 to 105.0 Heating/cooling: -105.0 to 105.0		0.0	%
MV at PV Error	MV-E	Same as the MV at Stop parameter.		0.0	%
SP Ramp Set Value	SPRSE	OFF, 1 to 9,999	OFF, 1 to 9999	OFF	EU/s, EU/min, EU/h
SP Ramp Fall Value	SPRFL	SAME, OFF, or 1 to 9,999	SAME, OFF, 1 to 9999	SAME	EU/s, EU/min, EU/h
MV Upper Limit	UL-H	Standard control: MV lower limit + 0.1 to 105.0 Heating/cooling control: 0.0 to 105.0		100.0	%
MV Lower Limit	UL-L	Standard control: -5.0 to MV upper limit - 0.1		0.0	%
		Heating/cooling control: -105.0 to 0.0		-100.0	
MV Change Rate Limit	CRL	0.0 to 100.0 (0.0: MV Change Rate Limit Disabled)		0.0	%/s
Extraction of Square Root Low-cut Point	SRPP	0.0 to 100.0		0.0	%
Work Bit * ON Delay	WI to BOON	0 to 9999		0	Seconds
Work Bit * OFF Delay	WI to BOFF	0 to 9999		0	Seconds
Communications Monitor	PLCM	0 to 9999			ms

*1 This parameter is not displayed for heating/cooling control.

A-7-3 Initial Setting Level

Parameters	Characters	Setting (monitor) value	Display	Default	Unit	
Input Type	IN-E	Temperature input	0: Pt100 1: Pt100 2: Pt100 3: JPt100 4: JPt100 5: K 6: K 7: J 8: J 9: T 10: T 11: E 12: L 13: U 14: U 15: N 16: R 17: S 18: B 19: C/W 20: PLII 21: 10 to 70°C 22: 60 to 120°C 23: 115 to 165°C 24: 140 to 260°C		5	None
		Analog input	25: 4 to 20 mA 26: 0 to 20 mA 27: 1 to 5 V 28: 0 to 5 V 29: 0 to 10 V		5	None
Scaling Upper Limit	IN-H	Scaling lower limit + 1 to 9,999		100	None	
Scaling Lower Limit	IN-L	-1,999 to scaling upper limit -1		0	None	
Decimal Point	dP	0 to 3		0	None	
Temperature Unit	d-U	°C, °F	C, F	°C	None	
SP Upper Limit	SL-H	Temperature input: SP lower limit + 1 to Input setting range upper limit		1300	EU	
		Analog input: SP lower limit + 1 to scaling upper limit		100		
SP Lower Limit	SL-L	Temperature input: Input setting range lower limit to SP upper limit - 1		-200	EU	
		Analog input: Scaling lower limit to SP upper limit - 1		0		
PID ON/OFF	ENEL	ON/OFF 2-PID	ONOFF, PID	2-PID control	None	
Standard or Heating/Cooling	S-HC	Standard or heating/cooling	StNd, H-C	Standard	None	
Adaptive Control	AdPt	OFF: Disabled FIX: Fixed INFO: Notification AUTO: Automatic update	OFF, FIX, INFO, AUTO	OFF	None	
Model Creation PV Amplitude	M-PV	0.00 to 99.99		0.00	%FS	
Model Creation MV Amplitude	M-MV	0.0 to 100.0		0.0	%FS	
Model Creation ON Time	M-ON	0 to 9999		0	---	
Model Creation OFF Time	M-OFF	0 to 9999		0	---	
Program Pattern	PtRN	OFF, STOP, CONT	OFF, StOP, CONT	OFF	None	

Parameters	Characters	Setting (monitor) value	Display	Default	Unit
Control Period (Heating)	\overline{CP}	0.1, 0.2, 0.5, or 1 to 99	$0.1, 0.2, 0.5, 1$ to 99	Relay output: 20 Voltage output (for driving SSR): 2	Seconds
Control Period (Cooling)	\overline{CP}	0.1, 0.2, 0.5, or 1 to 99	$0.1, 0.2, 0.5, 1$ to 99	Relay output: 20 Voltage output (for driving SSR): 2	Seconds
Direct/Reverse Operation	\overline{REV}	Reverse operation, direct operation	$\overline{RR-R}, \overline{RR-d}$	Reverse operation	None
Alarm 1 Type	$\overline{RLT1}$	0: Alarm function OFF 1: Upper and lower-limit alarm 2: Upper-limit alarm 3: Lower-limit alarm 4: Upper and lower-limit range alarm 5: Upper- and lower-limit alarm with standby sequence 6: Upper-limit alarm with standby sequence 7: Lower-limit alarm with standby sequence 8: Absolute-value upper-limit alarm 9: Absolute-value lower-limit alarm 10: Absolute-value upper-limit alarm with standby sequence 11: Absolute-value lower-limit alarm with standby sequence 12: LBA (Loop Burnout Alarm) 13: PV change rate alarm 14: SP absolute-value upper-limit alarm 15: SP absolute-value lower-limit alarm 16: MV absolute-value upper-limit alarm 17: MV absolute-value lower-limit alarm		2	None
Alarm 1 Hysteresis	$\overline{RLH1}$	Temperature input: 0.1 to 999.9 for all alarms except for MV absolute-value upper-limit or MV lower-limit alarms		0.2	°C
				0.4	°F
		Analog input: 0.01 to 99.99 for all alarms except for MV absolute-value upper-limit or MV lower-limit alarms		0.02	%FS
		0.01 to 99.99 for MV absolute-value upper-limit or MV lower-limit alarms		0.50	%
Alarm 2 Type	$\overline{RLT2}$	Same as Alarm 1 Type except that 12 (LBA) cannot be set.		2	None
Alarm 2 Hysteresis	$\overline{RLH2}$	Temperature input: 0.1 to 999.9 for all alarms except for MV absolute-value upper-limit or MV lower-limit alarms		0.2	°C
				0.4	°F
		Analog input: 0.01 to 99.99 for all alarms except for MV absolute-value upper-limit or MV lower-limit alarms		0.02	%FS
		0.01 to 99.99 for MV absolute-value upper-limit or MV lower-limit alarms		0.50	%
Alarm 3 Type	$\overline{RLT3}$	Same as Alarm 1 Type except that 12 (LBA) cannot be set.		2	None
Alarm 3 Hysteresis	$\overline{RLH3}$	Temperature input: 0.1 to 999.9 for all alarms except for MV absolute-value upper-limit or MV lower-limit alarms		0.2	°C
				0.4	°F
		Analog input: 0.01 to 99.99 for all alarms except for MV absolute-value upper-limit or MV lower-limit alarms		0.02	%FS
		0.01 to 99.99 for MV absolute-value upper-limit or MV lower-limit alarms		0.50	%
Alarm 4 Type	$\overline{RLT4}$	Same as Alarm 1 Type except that 12 (LBA) cannot be set.		2	None

Parameters	Characters	Setting (monitor) value	Display	Default	Unit
Alarm 4 Hysteresis	RLHY	Temperature input: 0.1 to 999.9 for all alarms except for MV absolute-value upper-limit or MV lower-limit alarms		0.2	°C
				0.4	°F
		Analog input: 0.01 to 99.99 for all alarms except for MV absolute-value upper-limit or MV lower-limit alarms		0.02	%FS
			0.01 to 99.99 for MV absolute-value upper-limit or MV lower-limit alarms		0.50
Control Output 1 Signal	ā15t	4-20: 4-20 mA 0-20: 0-20 mA	4-20, 0-20	4-20	None
Transfer Output Signal 000	tR5t	4-20: 4-20 mA 1-5: 1-5 V	4-20, 1-5V	OFF	None
Transfer Output Type 000	tR-t	OFF: OFF SP: Set point SP-M: Ramp set point PV: Process value MV: MV (heating) CMV: MV (cooling) (Supported only for heating/cooling control.)	āFF SP SP-M PV MV [-MV		
Transfer Output Upper Limit 000	tR-H	*5		*5	*5
Transfer Output Lower Limit 000	tR-L	*5		*5	*5
Event Input Assignment 1	tV-1	NONE: None STOP: RUN/STOP MANU: Auto/Manual Switch PRST: Program Start *1 DRS: Invert Direct/Reverse Operation NONE: None AT-2: 100% AT Execute/Cancel AT-1: 40% AT Execute/Cancel *2 WTPT: Setting Change Enable/Disable Communications Writing Enable/Disable (Communications must be supported.) LAT: Alarm Latch Cancel MSP0: Multi-SP No. switching bit 0 MSP1: Multi-SP No. switching bit 1 MSP2: Multi-SP No. switching bit 2 RUN: STOP/RUN A-UD: PID Update (Adaptive Control) FA: Automatic Filter Adjustment W-HT: Water-cooling Output Adjustment	NONE StāP MANU PR5t dRS NONE Rt-2 Rt-1 WtPt [-MWE LRt MSP0 MSP1 MSP2 RUN R-ud FR W-Ht	MSP0	None
Event Input Assignment 2	tV-2	Same as Event Input Assignment 1.	Same as Event Input Assignment 1.	STOP	None
Event Input Assignment 3	tV-3	Same as Event Input Assignment 1.	Same as Event Input Assignment 1.	NONE	None
Event Input Assignment 4	tV-4	Same as Event Input Assignment 1.	Same as Event Input Assignment 1.	NONE	None
Event Input Assignment 5	tV-5	Same as Event Input Assignment 1.	Same as Event Input Assignment 1.	NONE	None
Event Input Assignment 6	tV-6	Same as Event Input Assignment 1.	Same as Event Input Assignment 1.	NONE	None
Extraction of Square Root Enable	SR	OFF: ON	āFF, āN	OFF(0)	None

Parameters	Characters	Setting (monitor) value	Display	Default	Unit
Operation After Power ON	P-ON	CONT: Continue STOP: Stop MANU: Manual	CONT STOP MANU	CONT	None
Bar Display Data	BAR	OFF: Nothing displayed. MV: MV (heating) C-MV: MV (cooling) CT-1: Heater current 1	OFF MV C-MV CT-1	MV*3	---
Bar Display Scaling Upper Limit	BARH	-199.9 to 999.9	---	100.0*4	<ul style="list-style-type: none"> • For MV (heating) or MV (cooling): % • For heater current: A
Bar Display Scaling Lower Limit	BARL	-199.9 to 999.9	---	0.0	
Move to Advanced function Setting Level	AMOV	-1,999 to 9,999	---	0	None

- *1 PRST (Program Start) can be set even when the Program Pattern parameter is set to OFF, but the function will be disabled.
- *2 This function can be set for heating/cooling control, but the function will be disabled.
- *3 The default value for the E5□D-□-8□□ is CT-1 (Heater current 1).
- *4 The default value for the E5□D-□-8□□ is 50.0.
- *5

Transfer output type	Setting (monitor) range	Default*3.1 (transfer output upper/lower limits)	Unit
Set Point	SP lower limit to SP upper limit	SP upper limit/lower limit	EU
Set Point During SP Ramp	SP lower limit to SP upper limit	SP upper limit/lower limit	EU
PV	Temperature input: Input setting range lower limit to Input setting range upper limit	Input setting range upper/lower limit	EU
	Analog input: Scaling lower limit to Scaling upper limit	Scaling upper/lower limit	
MV (Heating)	Standard: -5.0 to 105.0 Heating/cooling: 0.0 to 105.0	100.0/0.0	%
MV (Cooling)	0.0 to 105.0	100.0/0.0	%

- *3.1 Initialized when the transfer output type is changed.
 Initialized if the input type, temperature unit, scaling upper/lower limit, or SP upper/lower limit is changed when the transfer output type is SP, ramp SP, or PV.
 (When initialized by the initializing settings, it is initialized to 100.0/0.0.)

A-7-4 Manual Control Level

Parameters	Setting (monitor) value	Default	Unit
Manual MV	-5.0 to 105.0 (standard)* -105.0 to 105.0 (heating/cooling)*	0.0	%

* When the Manual MV Limit Enable parameter is set to ON, the setting range will be the MV lower limit to the MV upper limit.

A-7-5 Monitor/Setting Item Level

The contents displayed vary depending on the Monitor/Setting 1 to 5 (advanced function setting level) setting.

A-7-6 Advanced Function Setting Level

Parameters	Characters	Setting (monitor) value	Display	Default	Unit
Parameter Initialization	INIL	OFF, FACT	OFF, FACL	OFF	None
Number of Multi-SP Points	MSPU	OFF, 2 to 8	OFF, 2 to 8	OFF	None
SP Ramp Time Unit	SPRU	S: EU/second M: EU/minute H: EU/hour	S, M, H	M	None
Standby Sequence Reset	RESL	Condition A, condition B	A, B	Condition A	None
Auxiliary Output 1 Open in Alarm	SB1N	N-O: Close in alarm N-C: Open in alarm	N- \bar{a} , N- \bar{c}	N-O	None
Auxiliary Output 2 Open in Alarm	SB2N	N-O: Close in alarm N-C: Open in alarm	N- \bar{a} , N- \bar{c}	N-O	None
Auxiliary Output 3 Open in Alarm	SB3N	N-O: Close in alarm N-C: Open in alarm	N- \bar{a} , N- \bar{c}	N-O	None
Auxiliary Output 4 Open in Alarm	SB4N	N-O: Close in alarm N-C: Open in alarm	N- \bar{a} , N- \bar{c}	N-O	None
HB ON/OFF	HBUL	OFF, ON	OFF, ON	ON	None
Heater Burnout Latch	HBLL	OFF, ON	OFF, ON	OFF	None
Heater Burnout Hysteresis	HBHL	0.1 to 50.0		0.1	A
α	ALFA	0.00 to 1.00		0.65	None
Integral/Derivative Time Unit	EDUL	1, 0.1	1, 0.1	1	Second
AT Calculated Gain	ALGL	0.1 to 10.0		0.8	None
AT Hysteresis	ALHL	Temperature input: 0.1 to 999.9		0.8	°C
		Analog input: 0.01 to 9.99		1.4	°F
Limit Cycle MV Amplitude	LCMA	5.0 to 50.0		0.20	%FS
				20.0	%
Moving Average Count	MARV	OFF, 2, 4, 8, 16, or 32		OFF ^{*5}	Times
Automatic Display Return Time	REEL	OFF, 1 to 99	OFF, 1 to 99	OFF	Second
Display Brightness	BRGL	1 to 3		3	None
Alarm 1 Latch	A1LE	OFF, ON	OFF, ON	OFF	None
Alarm 2 Latch	A2LE	OFF, ON	OFF, ON	OFF	None
Alarm 3 Latch	A3LE	OFF, ON	OFF, ON	OFF	None
Alarm 4 Latch	A4LE	OFF, ON	OFF, ON	OFF	None
Move to Protect Level Time	PRLT	1 to 30		3	Second
Cold Junction Compensation Method	CLCL	OFF, ON	OFF, ON	ON	None
Alarm 1 ON Delay	A1ON	0 to 999 (0: ON delay disabled)		0	Second
Alarm 2 ON Delay	A2ON	0 to 999 (0: ON delay disabled)		0	Second

Parameters	Characters	Setting (monitor) value	Display	Default	Unit
Alarm 3 ON Delay	R3ON	0 to 999 (0: ON delay disabled)		0	Second
Alarm 4 ON Delay	R4ON	0 to 999 (0: ON delay disabled)		0	Second
Alarm 1 OFF Delay	R1OF	0 to 999 (0: OFF delay disabled)		0	Second
Alarm 2 OFF Delay	R2OF	0 to 999 (0: OFF delay disabled)		0	Second
Alarm 3 OFF Delay	R3OF	0 to 999 (0: OFF delay disabled)		0	Second
Alarm 4 OFF Delay	R4OF	0 to 999 (0: OFF delay disabled)		0	Second
Manual Output Method	MANL	HOLD or INIT	HOLD, INIT	HOLD	None
Manual MV Initial Value	MANV	-5.0 to 105.0 for standard control *1 -105.0 to 105.0 for heating/cooling control *1		0.0	%
RT	RL	OFF, ON	OFF, ON	OFF	None
HS Alarm Use	HSU	OFF, ON	OFF, ON	ON	None
HS Alarm Latch	HSL	OFF, ON	OFF, ON	OFF	None
HS Alarm Hysteresis	HSH	0.1 to 50.0		0.1	A
LBA Detection Time	LbA	0 to 9999 (0: LBA function disabled)		0	Second
LBA Level	LbAL	Temperature input: 0.1 to 999.9		8.0	°C
				14.4	°F
		Analog input: 0.01 to 99.99		10.00	%FS
LBA Band	LbAb	Temperature input: 0.0 to 999.9		3.0	°C
				5.4	°F
		Analog input: 0.00 to 99.99		0.20	%FS
Control Output 1 Assignment	OUT 1	<ul style="list-style-type: none"> Relay Output or Voltage Output (for Driving SSR) *4 NONE: None O: Control output (heating) C-O: Control output (cooling) ALM1: Alarm 1 ALM2: Alarm 2 ALM3: Alarm 3 ALM4: Alarm 4 HA: Heater alarm (HB + HS) HB: Heater burnout alarm (HB) HS: Heater short alarm (HS) S.ERR: Input error NONE: None P.END: Program End output *2 RUN: RUN output ALM: Integrated alarm WR1: Work bit 1 *3 WR2: Work bit 2 *3 WR3: Work bit 3 *3 WR4: Work bit 4 *3 WR5: Work bit 5 *3 WR6: Work bit 6 *3 WR7: Work bit 7 *3 WR8: Work bit 8 *3 For Linear Current Output *4 NONE : Not assigned. O: Control output (heating) C-O: Control output (cooling) 	NONE O C-O ALM1 ALM2 ALM3 ALM4 HA HB HS S.ERR NONE P.END RUN ALM WR1 WR2 WR3 WR4 WR5 WR6 WR7 WR8 NONE O C-O	0	None

Parameters	Characters	Setting (monitor) value	Display	Default	Unit
Control Output 2 Assignment	<i>ōUŁ²</i>	Same as for the Control Output 1 Assignment parameter except for the setting (monitor) value marked with ^{*2} .	Same as for the Control Output 1 Assignment parameter except for the setting (monitor) value marked with ^{*2} .	NONE	None
Auxiliary Output 1 Assignment	<i>5UŁ1</i>	NONE: None O: Control output (heating) C-O: Control output (cooling) ALM1: Alarm 1 ALM2: Alarm 2 ALM3: Alarm 3 ALM4: Alarm 4 HA: Heater alarm (HB + HS) HB: Heater burnout alarm (HB) HS: Heater short alarm (HS) S.ERR: Input error NONE: None P.END: Program end output ^{*2} RUN: RUN output ALM: Integrated alarm WR1: Work bit 1 ^{*3} WR2: Work bit 2 ^{*3} WR3: Work bit 3 ^{*3} WR4: Work bit 4 ^{*3} WR5: Work bit 5 ^{*3} WR6: Work bit 6 ^{*3} WR7: Work bit 7 ^{*3} WR8: Work bit 8 ^{*3}	NōNE ō Ć - ō RLM1 RLM2 RLM3 RLM4 HR Hb HS S.ERR NōNE P.END RUN RLM WR1 WR2 WR3 WR4 WR5 WR6 WR7 WR8	ALM1 *Digital Controllers without HB and HS alarm detection: HA	None
Auxiliary Output 2 Assignment	<i>5UŁ²</i>	Same as the Auxiliary Output 1 Assignment parameter.	Same as the Auxiliary Output 1 Assignment parameter.	ALM2	None
Auxiliary Output 3 Assignment	<i>5UŁ3</i>	Same as the Auxiliary Output 1 Assignment parameter.	Same as the Auxiliary Output 1 Assignment parameter.	ALM3	None
Auxiliary Output 4 Assignment	<i>5UŁ4</i>	Same as the Auxiliary Output 1 Assignment parameter.	Same as the Auxiliary Output 1 Assignment parameter.	ALM4	None
Integrated Alarm Assignment	<i>RLMR</i>	0 to 255 Alarm 1: +1 Alarm 2: +2 Alarm 3: +4 Alarm 4: +8 HB alarm: +16 HS alarm: +32 Input error: +64 +128: (Not used)		49	None
Soak Time Unit	<i>Ł-U</i>	M: Minutes H: Hours S: Seconds	<i>M, H, S</i>	M	None
Alarm SP Selection	<i>RLSP</i>	SP-M: Ramp set point SP: Set point	<i>SP-M, SP</i>	SP-M	None

Parameters	Characters	Setting (monitor) value	Display	Default	Unit
Manual MV Limit Enable	<i>MANL</i>	OFF, ON	<i>OFF, ON</i>	OFF	None
PV Rate of Change Calculation Period	<i>PV RP</i>	1 to 999		20 (1S)	Sampling period
Heating/Cooling Tuning Method	<i>HELM</i>	0: Same as heating control 1: Linear 2: Air cooling 3: Water cooling		0	None
Minimum Output ON/OFF Band	<i>AMPW</i>	0.0 to 50.0		1.0	%
PF Setting	<i>PF</i>	OFF: OFF RUN: RUN STOP: STOP R-S: RUN/STOP AT-2: 100% AT execute/cancel AT-1: 40% AT execute/cancel LAT: Alarm Latch Cancel A-M: Auto/manual PFDP: Monitor/setting item SHFT: Digit Shift Key A-UD: PID Update (Adaptive Control) FA: Automatic Filter Adjustment W-HT: Water-cooling Output Adjustment	<i>OFF</i> <i>RUN</i> <i>STOP</i> <i>R-S</i> <i>AT-2</i> <i>AT-1</i> <i>LAT</i> <i>A-M</i> <i>PFdP</i> <i>SHFT</i> <i>A-UD</i> <i>FA</i> <i>W-HT</i>	SHFT	None
Monitor/Setting Item 1	<i>PFd1</i>	0: Disabled 1: PV/SP/Multi-SP 2: PV/SP/MV (Heating) 3: PV/SP/Soak time remain 4: Proportional band (P) 5: Integral time (I) 6: Derivative time (D) 7: Alarm value 1 8: Alarm value upper limit 1 9: Alarm value lower limit 1 10: Alarm value 2 11: Alarm value upper limit 2 12: Alarm value lower limit 2 13: Alarm value 3 14: Alarm value upper limit 3 15: Alarm value lower limit 3 16: Alarm value 4 17: Alarm value upper limit 4 18: Alarm value lower limit 4 19: PV/SP/Internal SP 20: PV/SP/Alarm value 1 21: Proportional Band (Cooling) (C-P) 22: Integral Time (Cooling) (C-I) 23: Derivative Time (Cooling) (C-D) 24: PV/SP/MV (Cooling)		1	None
Monitor/Setting Item 2	<i>PFd2</i>	Same as Monitor/Setting Item 1.		0	None
Monitor/Setting Item 3	<i>PFd3</i>	Same as Monitor/Setting Item 1.		0	None
Monitor/Setting Item 4	<i>PFd4</i>	Same as Monitor/Setting Item 1.		0	None
Monitor/Setting Item 5	<i>PFd5</i>	Same as Monitor/Setting Item 1.		0	None
PV/SP No. 1 Display Selection	<i>SPd1</i>	0: Nothing is displayed. 1: PV/SP/Nothing displayed 2: PV/Nothing displayed/Nothing displayed 3: SP/SP (character display)/Nothing displayed 4: PV/SP/MV (heating) 5: PV/SP/Multi-SP No. 6: PV/SP/Soak time remain 7: PV/SP/Internal SP (ramp SP) 8: PV/SP/Alarm value 1 9: PV/SP/MV (cooling)		4 * The default value for the E5□D-□-8□□ is 1.	None
PV/SP No. 2 Display Selection	<i>SPd2</i>	Same as PV/SP No. 1 Display Selection.		0	None

Parameters	Characters	Setting (monitor) value	Display	Default	Unit
PV Status Display Function	PVSt	OFF: OFF MANU: Manual STOP: Stop ALM1: Alarm 1 ALM2: Alarm 2 ALM3: Alarm 3 ALM4: Alarm 4 ALM: OR of alarms 1 to 4 HA: Heater alarm	OFF MANU StOP ALM1 ALM2 ALM3 ALM4 ALM HA	OFF	None
SV Status Display Function	SVSt	OFF: OFF MANU: Manual STOP: Stop ALM1: Alarm 1 ALM2: Alarm 2 ALM3: Alarm 3 ALM4: Alarm 4 ALM: OR of alarms 1 to 4 HA: Heater alarm	OFF MANU StOP ALM1 ALM2 ALM3 ALM4 ALM HA	OFF	None
Display Refresh Period	dREF	OFF, 0.25, 0.5, 1.0	OFF, 0.25, 0.5, 1.0	0.25	Second
LCT Cooling Output Minimum ON Time	LcMt	0.1 to 1.0		0.2	Second
Adaptive Control Operation Possible Deviation	R-dV	0.0 to 100.0		50.0	% 0°C (32°F) to Set point = 100%
System Fluctuation Reference Deviation	R-SD	0.0 to 100.0		15.0	%
Automatic Filter Adjustment Seal Period	FASP	0.1 to 10.0		2.0	Seconds
Automatic Filter Adjustment Hunting Monitor Period	FAHP	10 to 1999		200	Seconds
Water-cooling Proportional Band Increase Constant	W-LI	1.00 to 10.00		1.70	
Water-cooling Proportional Band Decrease Constant	W-dI	0.10 to 0.99		0.90	
Power ON Time Monitor	PWEM	0 to 9999		0	10 hours
Ambient Temperature Monitor	RbEM	°C: -30 to 75, °F: 10 to 171			°C °F
Control Output 1 ON/OFF Count Monitor Control Output 2 ON/OFF Count Monitor	RR1M RR2M	0 to 9999		0	100 times
ON/OFF Counter Reset	RRL	0: Resetting is disabled. 1: Control Output 1 ON/OFF Count Monitor parameter is reset. 2: Control Output 2 ON/OFF Count Monitor parameter is reset.		0	
Parameter Mask Setting	PMSt	OFF, ON	OFF, ON	OFF	None
Move to Calibration Level	EMdV	-1999 to 9999		0	None

- *1 If the Manual MV Limit Enable parameter is set to ON, the setting range will be the MV lower limit to the MV upper limit.
- *2 This parameter can be set when the Program Pattern parameter is set to OFF, but the function will be disabled.
- *3 WR1 to WR8 are not displayed when the logic operation function is not used.
- *4 The setting ranges are different for relay and voltage outputs (for driving SSR) and for linear current outputs.
- *5 The default value for the E5□D-□-8□□ is 8.

A-7-7 Protect Level

Parameters	Characters	Setting (monitor) value	Display	Default	Unit
Move to Protect level	<i>PMδV</i>	-1999 to 9999		0	None
Operation/Adjustment Protect	<i>δRPL</i>	0 to 3		0	None
Initial Setting/Communications Protect	<i>δCP</i>	0 to 2		1	None
Setting Change Protect	<i>WLP</i>	OFF, ON	<i>δFF, δN</i>	OFF	None
PF Key Protect	<i>PFP</i>	OFF, ON	<i>δFF, δN</i>	OFF	None
Parameter Mask Enable	<i>PMSk</i>	OFF, ON	<i>δFF, δN</i>	ON	None
Password to Move to Protect Level	<i>PRLP</i>	-1,999 to 9,999		0	None

A-7-8 Communications Setting Level

Parameters	Characters	Setting (monitor) value	Display	Default	Unit
Protocol Setting	<i>PSEL</i>	CWF: CompoWay/F MOD: Modbus NONE: Disabled FINS: Host Link (FINS) MCP4: MC Protocol (format 4) FXP4: Dedicated protocol (format 4)	<i>CWF</i> <i>Mod</i> <i>NONE</i> <i>FINS</i> <i>MCP4</i> <i>FXP4</i>	CompoWay/ F	None
Communications Unit No.	<i>U-Nδ</i>	0 to 99		1	None
Communications Baud Rate	<i>bPS</i>	9.6, 19.2, 38.4, 57.6, or 115.2	<i>9.6, 19.2, 38.4, 57.6, 115.2</i>	9.6	kbps
Communications Data Length	<i>LEN</i>	7, 8		7	Bit
Communications Stop Bits	<i>SbL</i>	1, 2		2	Bit
Communications Parity	<i>PRLY</i>	NONE: None EVEN: Even ODD: Odd	<i>NONE, EVEN, odd</i>	Even	None
Send Data Wait Time	<i>SdWT</i>	0 to 99		20	ms
Write Mode	<i>RRMM</i>	BKUP: Backup Mode RAM: RAM Write Mode	<i>bKUP, RAM</i>	BKUP	None
Highest Communications Unit No.	<i>MAXU</i>	0 to 99		0	None
Area	<i>AREA</i>	0 to 25		0	None
First Address Upper Word	<i>RdRH</i>	0 to 99		0	None
First Address Lower Word	<i>RdRL</i>	0 to 9999		0	None
Receive Data Wait Time	<i>RWR</i>	100 to 9999		1000	ms
Communications Node Number	<i>UNL</i>	0 to 99		0	None
Upload Settings 1 to 13	<i>UP 1 to 13</i>	0 to 108			None
Download Settings 1 to 13	<i>dN 1 to 13</i>	30 to 108			None
Copy	<i>δPY</i>	OFF, ALL, or 1 to 199		OFF	None

A-7-9 Initialization According to Parameter Changes

The parameters that are initialized when parameters are changed are shown under Related initialized parameters.

Changed parameter / Related initialized parameters	Input Type	Temperature Unit	Scaling Upper Limit	SP Lower Limit	SP Upper Limit	PID ON/OFF	Standard or Heating/Cooling	RT	Integral/Derivative Time Unit	Alarm 1 to 4 Type	Heating/Cooling Tuning Method	Program Pattern	Adaptive Control	Model Creation PV Amplitude	Model Creation MV Amplitude	Model Creation ON Time	Model Creation OFF Time	AT Calculated Gain	Number of Multi-SP Points	Password to Move to Protect Level	Transfer Output Type
Related parameter initialization execution condition	---	Temperature input	Analog input	---	---	---	---	Temperature input	---	---	---	---	---	---	---	---	---	---	---	---	---
SP Upper Limit	● *1	● *15	● *1	---	---	---	---	---	---	---	---	---	---	---	---	---	---	---	---	---	---
SP Lower Limit	---	---	---	---	---	---	---	---	---	---	---	---	---	---	---	---	---	---	---	---	---
SP, Multi-SP Set Points 0 to 7 Selection	● *2	● *2 *15	● *2	● *2	---	---	---	---	---	---	---	---	---	---	---	---	---	---	---	---	---
RT	● *3	---	---	---	---	---	---	---	---	---	---	●	---	---	---	---	---	---	---	---	---
Integral/Derivative Time Unit	---	---	---	---	---	---	● *8	---	---	---	---	---	---	---	---	---	---	---	---	---	---
MV at Stop	---	---	---	---	---	---	●	---	---	---	---	---	---	---	---	---	---	---	---	---	---
MV at PV Error	---	---	---	---	---	---	●	---	---	---	---	---	---	---	---	---	---	---	---	---	---
Manual MV Initial Value	---	---	---	---	---	---	●	---	---	---	---	---	---	---	---	---	---	---	---	---	---
Control Output 1 Assignment	---	---	---	---	---	---	●	---	---	---	---	●	---	---	---	---	---	---	---	---	---
Control Output 2 Assignment	---	---	---	---	---	---	●	---	---	---	---	●	---	---	---	---	---	---	---	---	---
Auxiliary Output 1 Assignment	---	---	---	---	---	---	●	---	---	---	---	●	---	---	---	---	---	---	---	---	---
Auxiliary Output 2 Assignment	---	---	---	---	---	---	●	---	---	---	---	●	---	---	---	---	---	---	---	---	---
Auxiliary Output 3 Assignment	---	---	---	---	---	---	●	---	---	---	---	●	---	---	---	---	---	---	---	---	---
Auxiliary Output 4 Assignment	---	---	---	---	---	---	●	---	---	---	---	●	---	---	---	---	---	---	---	---	---
Move to Protect Level	---	---	---	---	---	---	---	---	---	---	---	---	---	---	---	---	---	---	---	● *9	---
Dead Band	● *10	● *15	---	---	---	---	---	---	---	---	---	---	---	---	---	---	---	---	---	---	---
Hysteresis (Heating)	● *10	● *15	---	---	---	---	---	---	---	---	---	---	---	---	---	---	---	---	---	---	---
Hysteresis (Cooling)	● *10	● *15	---	---	---	---	---	---	---	---	---	---	---	---	---	---	---	---	---	---	---
Wait Band	● *10	● *15	---	---	---	---	---	---	---	---	---	---	---	---	---	---	---	---	---	---	---
Alarm 1 to 4 Hysteresis	● *11	● *15	---	---	---	---	---	---	---	● *12	---	---	---	---	---	---	---	---	---	---	---
AT Hysteresis	● *10	● *15	---	---	---	---	---	---	---	---	---	---	---	---	---	---	---	---	---	---	---
LBA Level	● *10	● *15	---	---	---	---	---	---	---	---	---	---	---	---	---	---	---	---	---	---	---
LBA Band	● *10	● *15	---	---	---	---	---	---	---	---	---	---	---	---	---	---	---	---	---	---	---
Operation After Power ON	---	---	---	---	---	●	---	---	---	---	---	---	---	---	---	---	---	---	---	---	---
Proportional Band	● *10	● *15	---	---	---	---	---	● *8	● *14	---	---	---	---	---	---	---	---	---	---	---	---
Proportional Band (Cooling)	● *10	● *15	---	---	---	---	---	● *8	● *14	---	---	---	---	---	---	---	---	---	---	---	---
Integral Time	● *10	---	---	---	---	---	---	● *8	● *14	---	---	---	---	---	---	---	---	---	---	---	---
Integral Time (Cooling)	● *10	---	---	---	---	---	---	● *8	● *14	---	---	---	---	---	---	---	---	---	---	---	---
Derivative Time	● *10	---	---	---	---	---	---	● *8	● *14	---	---	---	---	---	---	---	---	---	---	---	---
Derivative Time (Cooling)	● *10	---	---	---	---	---	---	● *8	● *14	---	---	---	---	---	---	---	---	---	---	---	---

Changed parameter	Input Type	Temperature Unit	Scaling Lower Limit	Scaling Upper Limit	SP Lower Limit	SP Upper Limit	PID ON/OFF	Standard or Heating/Cooling	RT	Integral/Derivative Time Unit	Alarm 1 to 4 Type	Heating/Cooling Tuning Method	Program Pattern	Adaptive Control	Model Creation PV Amplitude	Model Creation ON Time	Model Creation OFF Time	AT Calculated Gain	Number of Multi-SP Points	Password to Move to Protect Level	Transfer Output Type	
MV Upper Limit, MV Lower Limit	---	---	---	---	---	---	---	● ^{*4}	---	---	---	---	---	---	---	---	---	---	---	---	---	---
RUN/STOP	---	---	---	---	---	---	---	---	---	---	---	---	---	---	---	---	---	---	---	---	---	---
Auto/Manual Switch	---	---	---	---	---	---	●	---	---	---	---	---	---	---	---	---	---	---	---	---	---	---
Minimum Output ON/OFF Band	---	---	---	---	---	---	---	●	---	---	---	●	---	---	---	---	---	---	---	---	---	---
Alarm Values 1 to 4	---	● ^{*15}	---	---	---	---	---	---	---	---	---	---	---	---	---	---	---	---	---	---	---	---
Alarm Upper Values 1 to 4	---	● ^{*15}	---	---	---	---	---	---	---	---	---	---	---	---	---	---	---	---	---	---	---	---
Alarm Lower Values 1 to 4	---	● ^{*15}	---	---	---	---	---	---	---	---	---	---	---	---	---	---	---	---	---	---	---	---
PV Input Shift	---	● ^{*15}	---	---	---	---	---	---	---	---	---	---	---	---	---	---	---	---	---	---	---	---
SP Ramp Set Value (Rise Value)	---	● ^{*15}	---	---	---	---	---	---	---	---	---	---	---	---	---	---	---	---	---	---	---	---
SP Ramp Fall Value	---	● ^{*15}	---	---	---	---	---	---	---	---	---	---	---	---	---	---	---	---	---	---	---	---
Event Input Assignments 1 to 6	---	---	---	---	---	---	---	---	---	---	---	---	● ^{*7}	---	---	---	---	---	---	---	---	---
Model Creation PV Amplitude	●	●	---	---	---	---	---	---	---	---	---	---	---	---	---	---	---	---	---	---	---	---
Model Creation MV Amplitude	●	●	---	---	---	---	---	---	---	---	---	---	---	---	---	---	---	---	---	---	---	---
Model Creation ON Time	●	●	---	---	---	---	---	---	---	---	---	---	---	---	---	---	---	---	---	---	---	---
Model Creation OFF Time	●	●	---	---	---	---	---	---	---	---	---	---	---	---	---	---	---	---	---	---	---	---
SP Response Proportional Band	●	● ^{*15}	---	---	---	---	---	---	---	● ^{*16}	---	---	---	---	---	---	● ^{*17}	---	---	---	---	---
SP Response Integral Time	●	---	---	---	---	---	---	---	---	● ^{*16}	---	---	---	---	---	---	● ^{*17}	---	---	---	---	---
SP Response Derivative Time	●	---	---	---	---	---	---	---	---	● ^{*16}	---	---	---	---	---	---	● ^{*17}	---	---	---	---	---
SP Response Coefficient Number	●	●	---	---	---	---	---	---	---	●	---	---	---	---	---	---	●	---	---	---	---	---
Disturbance Proportional Band	●	● ^{*15}	---	---	---	---	---	---	---	● ^{*16}	---	---	---	---	---	---	● ^{*17}	---	---	---	---	---
Disturbance Integral Time	●	---	---	---	---	---	---	---	---	● ^{*16}	---	---	---	---	---	---	● ^{*17}	---	---	---	---	---
Disturbance Derivative Time	●	---	---	---	---	---	---	---	---	● ^{*16}	---	---	---	---	---	---	● ^{*17}	---	---	---	---	---
Water-cooling Proportional Band Increase Threshold	---	● ^{*15}	---	---	---	---	---	---	---	---	---	---	---	---	---	---	---	---	---	---	---	---
Water-cooling Proportional Band Decrease Threshold	---	● ^{*15}	---	---	---	---	---	---	---	---	---	---	---	---	---	---	---	---	---	---	---	---
Multi-SP	---	---	---	---	---	---	---	---	---	---	---	---	---	---	---	---	---	---	● ^{*13}	---	---	---
Transfer Output Upper Limit and Transfer Output Lower Limit *18	● ^{*18.1}	● ^{*18.1}	● ^{*18.1}	● ^{*18.1}	---	---	---	● ^{*18.2}	---	---	---	---	---	---	---	---	---	---	---	---	---	● ^{*18.3}

*1 Initialized to input setting range upper and lower limits, or scaling upper and lower limits.
 *2 Clamped by SP upper and lower limits.
 *3 This parameter is initialized only when the input type is changed to analog input. The RT parameter turns OFF.
 *4 Initialized as follows according to the Standard or Heating/Cooling parameter setting.
 • MV Upper Limit: 100.0
 • MV Lower Limit: Standard 0.0, heating/cooling -100.0

- *5 Initialized to control output (cooling) for heating and cooling control, according to the following.
(The defaults for standard control are the defaults in the parameter list.)
 - With control output 2: The Control Output 2 Assignment parameter is initialized to control output (cooling).
 - If the Digital Controller does not have control output 2 but has four auxiliary outputs, the Auxiliary Output 4 Assignment parameter is initialized to Control Output (Cooling).
 - Otherwise, the Auxiliary Output 2 Assignment parameter is initialized to Control Output (Cooling).
- *6 If the Program Pattern parameter is set to OFF, the Auxiliary Output 1 Assignment parameter is initialized as follows:
 - Digital Controllers with HB and HS alarms: Heater alarm
 - Digital Controllers without HB and HS alarms: Alarm 1
 If the Program Pattern parameter is not set to OFF, the Auxiliary Output 1 Assignment parameter is initialized to the program end output.
- *7 If the Program Start parameter is assigned when the program pattern is changed to OFF, the Program Start parameter will be initialized to "not assigned."
- *8 The Integral/Derivative Time Unit parameter is initialized only when the RT parameter is turned ON. The default is as follows:
 - Integral/Derivative Time Unit: 0.1 s (The PID parameters are also initialized when the Integral/Derivative Time Unit parameter is initialized.) *14
- *9 This parameter is initialized to the new Password to Move to Protect Level password.
- *10 These parameters are initialized when the Input Type parameter is changed from a temperature input to an analog input or from an analog input to a temperature input.
- *11 This parameter is initialized when the Input Type parameter is changed from a temperature input to an analog input or from an analog input to a temperature input. However, it is not initialized if the applicable alarm is an MV absolute-value upper-limit alarm or an MV absolute-value lower-limit alarm.
- *12 This parameter is initialized to 50 (0.50%) if a non-MV alarm is changed to an MV alarm. This parameter is initialized to 2 (0.2°C or 0.02%FS) if an MV alarm is changed to a non-MV alarm.
- *13 If the number of multi-SP points is decreased, the multi-SPs will be initialized to 0.
- *14 The proportional band is initialized to 8.0 for a temperature input and to 10.0 for an analog input. (The same thing applies to the cooling side.)
Integral time and derivative time are initialized as follows:
 - Integral/Derivative Time Unit of 1 s: integral time to 233, and derivative time to 40. (This applies to both the heating and cooling constants.)
 - Integral/Derivative Time Unit of 0.1 s: integral time to 233.0, and derivative time to 40.0. (This applies to both the heating and cooling constants.)
- *15 If the temperature unit is changed, the value is converted to the new temperature unit.
- *16 If all of the model parameters are not 0, they will be initialized for model parameter calculations. However, if any of the model parameters is 0, they will be initialized to the defaults.
- *17 If all of the model parameters are not 0, they will be initialized for model parameter calculations.
- *18 Initialization is performed as shown below if the Control Output 1 Assignment parameter is set to a transfer output. The initialization differs depending on the changed parameter and the transfer output setting.
 - Transfer SP: SP upper and lower limits
 - Transfer Ramp SP: SP upper and lower limits
 - Transfer PV: Input setting range upper and lower limits or scaling upper and lower limits
 - Transfer MV (Heating): 100.0/0.0
 - Transfer MV (Cooling): 100.0/0.0
- *18.1 Initialized only when the transfer output is set to Transfer SP, Transfer Ramp SP, or Transfer PV.
- *18.2 Initialized only when the transfer output is set to Transfer MV (Heating) or Simple Transfer MV (Cooling).
- *18.3 Initialized to the above default values regardless of the settings for changing the transfer output.

A-8 Sensor Input Setting Range, Indication Range, Control Range

	Specifications	Set value	Input setting range	Input indication range	
Resistance thermometer	Pt100	0	-200 to 850 (°C)/-300 to 1500 (°F)	-220 to 870 (°C)/-340 to 1540 (°F)	
		1	-199.9 to 500.0 (°C)/-199.9 to 900.0 (°F)	-199.9 to 520.0 (°C)/-199.9 to 940.0 (°F)	
	JPt100	2	0.0 to 100.0 (°C)/0.0 to 210.0 (°F)	-20.0 to 120.0 (°C)/-40.0 to 250.0 (°F)	
		3	-199.9 to 500.0 (°C)/-199.9 to 900.0 (°F)	-199.9 to 520.0 (°C)/-199.9 to 940.0 (°F)	
Thermocouple	K	4	0.0 to 100.0 (°C)/0.0 to 210.0 (°F)	-20.0 to 120.0 (°C)/-40.0 to 250.0 (°F)	
		5	-200 to 1300 (°C)/-300 to 2300 (°F)	-220 to 1320 (°C)/-340 to 2340 (°F)	
	J	6	-20.0 to 500.0 (°C)/0.0 to 900.0 (°F)	-40.0 to 520.0 (°C)/-40.0 to 940.0 (°F)	
		7	-100 to 850 (°C)/-100 to 1500 (°F)	-120 to 870 (°C)/-140 to 1540 (°F)	
	T	8	-20.0 to 400.0 (°C)/0.0 to 750.0 (°F)	-40.0 to 420.0 (°C)/-40.0 to 790.0 (°F)	
		9	-200 to 400 (°C)/-300 to 700 (°F)	-220 to 420 (°C)/-340 to 740 (°F)	
	E	10	-199.9 to 400.0 (°C)/-199.9 to 700.0 (°F)	-199.9 to 420.0 (°C)/-199.9 to 740.0 (°F)	
		11	-200 to 600 (°C)/-300 to 1100 (°F)	-220 to 620 (°C)/-340 to 1140 (°F)	
	L	12	-100 to 850 (°C)/-100 to 1500 (°F)	-120 to 870 (°C)/-140 to 1540 (°F)	
		13	-200 to 400 (°C)/-300 to 700 (°F)	-220 to 420 (°C)/-340 to 740 (°F)	
	U	14	-199.9 to 400.0 (°C)/-199.9 to 700.0 (°F)	-199.9 to 420.0 (°C)/-199.9 to 740 (°F)	
		15	-200 to 1300 (°C)/-300 to 2300 (°F)	-220 to 1320 (°C)/-340 to 2340 (°F)	
	ES1B Infrared Temperature Sensor	10 to 70°C	16	0 to 1700 (°C)/0 to 3000 (°F)	-20 to 1720 (°C)/-40 to 3040 (°F)
			17	0 to 1700 (°C)/0 to 3000 (°F)	-20 to 1720 (°C)/-40 to 3040 (°F)
		60 to 120°C	18	0 to 1800 (°C)/0 to 3200 (°F)	-20 to 1820 (°C)/-40 to 3240 (°F)
			19	0 to 2300 (°C)/0 to 3200 (°F)	-20 to 2320 (°C)/-40 to 3240 (°F)
115 to 165°C		20	0 to 1300 (°C)/0 to 2300 (°F)	-20 to 1320 (°C)/-40 to 2340 (°F)	
		21	0 to 90 (°C)/0 to 190 (°F)	-20 to 130 (°C)/-40 to 270 (°F)	
140 to 260°C	22	0 to 120 (°C)/0 to 240 (°F)	-20 to 160 (°C)/-40 to 320 (°F)		
	23	0 to 165 (°C)/0 to 320 (°F)	-20 to 205 (°C)/-40 to 400 (°F)		
Current input	4 to 20 mA	24	0 to 260 (°C)/0 to 500 (°F)	-20 to 300 (°C)/-40 to 580 (°F)	
		25	Any of the following ranges, by scaling: -1999 to 9999 -199.9 to 999.9 -19.99 to 99.99 -1.999 to 9.999	-5% to 105% of setting range. The display shows -1999 to 9999 (numeric range with decimal point omitted).	
Voltage input	1 to 5 V	26	0 to 20 mA		
		27	0 to 5 V		
		28	0 to 10 V		

- The default is 5.
- The applicable standards for each of the above input ranges are as follows:
K, J, T, E, N, R, S, B: JIS C1602-2015, IEC 60584-1
L: Fe-CuNi, DIN 43710-1985
U: Cu-CuNi, DIN 43710-1985
C/W: W5Re/W26Re, JIS C 1602-2015, ASTM E988-1990
JPt100: JIS C 1604-1989, JIS C 1606-1989
Pt100: JIS C 1604-1997, IEC 60751
PLII: According to Platinel II Electromotive Force Table by Engelhard Corp.

A-9 Setting Levels Diagram

This diagram shows all of the setting levels. To move to the Advanced Function Setting Level and Calibration Level, you must enter passwords. Some parameters are not displayed depending on the protect level setting and the conditions of use.

Control stops when you move from the Operation Level to the Initial Setting Level.

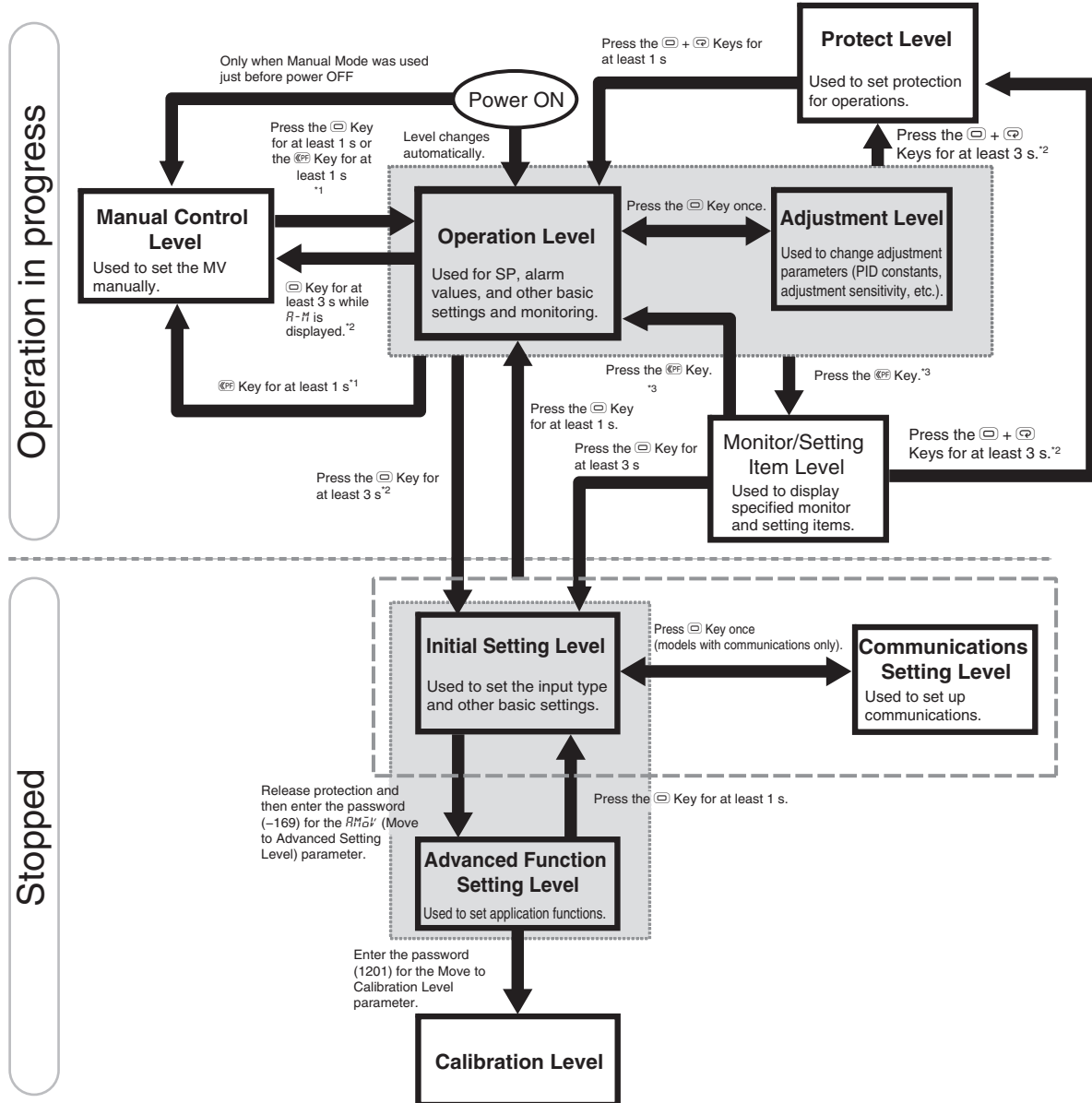

- *1 Set the PF Setting parameter to *R-M* (Auto/Manual).
- *2 The No. 1 display will flash when the keys are pressed for 1 s or longer.
- *3 Set the PF Setting parameter to *PFdP* (monitor/setting items).

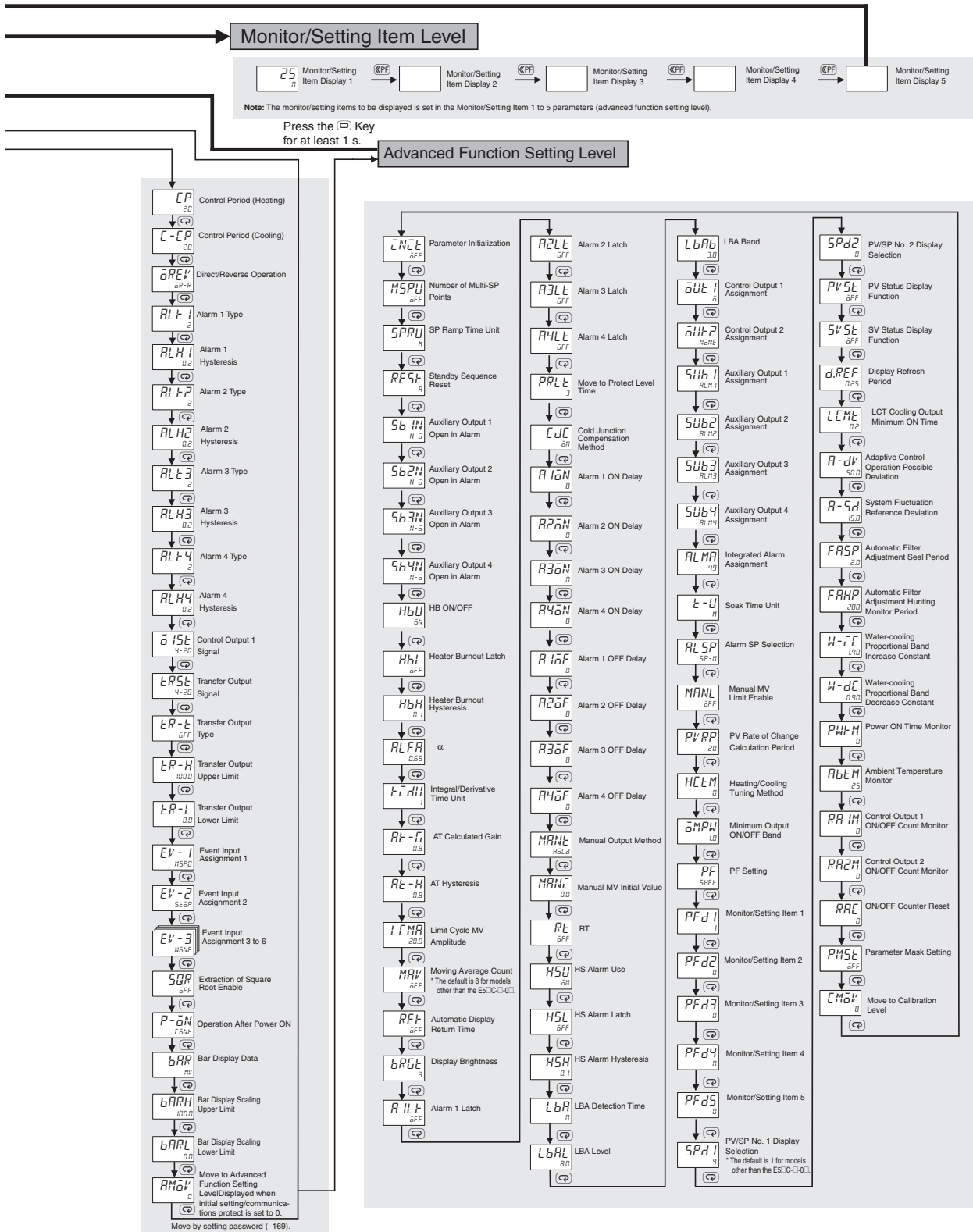

A-11 Parameter Flow (For E5□D-□-80□)

This section describes the parameters set in each level. Pressing the **MODE** (Mode) Key at the last parameter in each level returns to the top parameter in that level. Hold down the **MODE** Key to move through the parameters in reverse. Some parameters may not be displayed depending on the model and other settings.

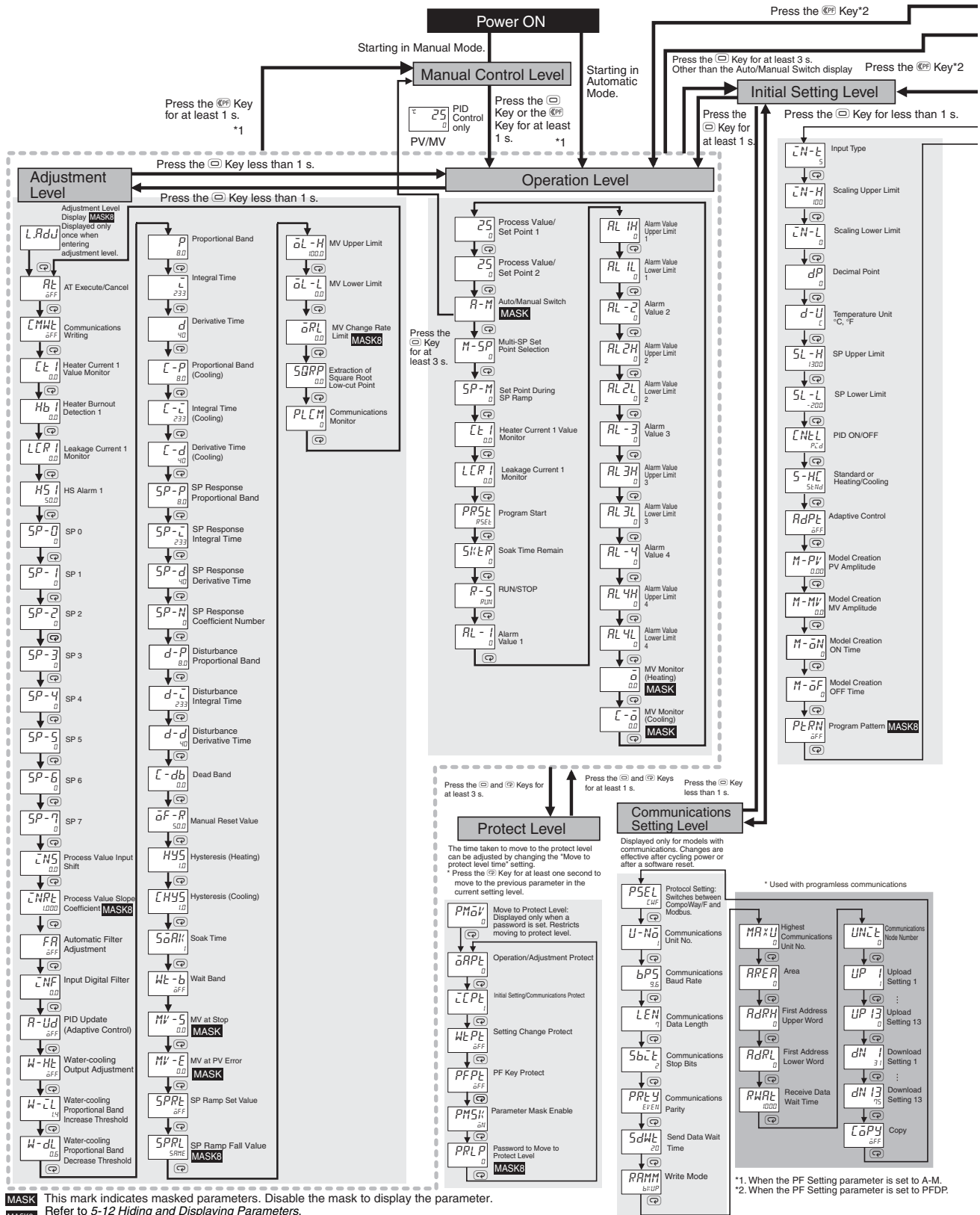

A-11 Parameter Flow (For E5□D-□-80□)

A

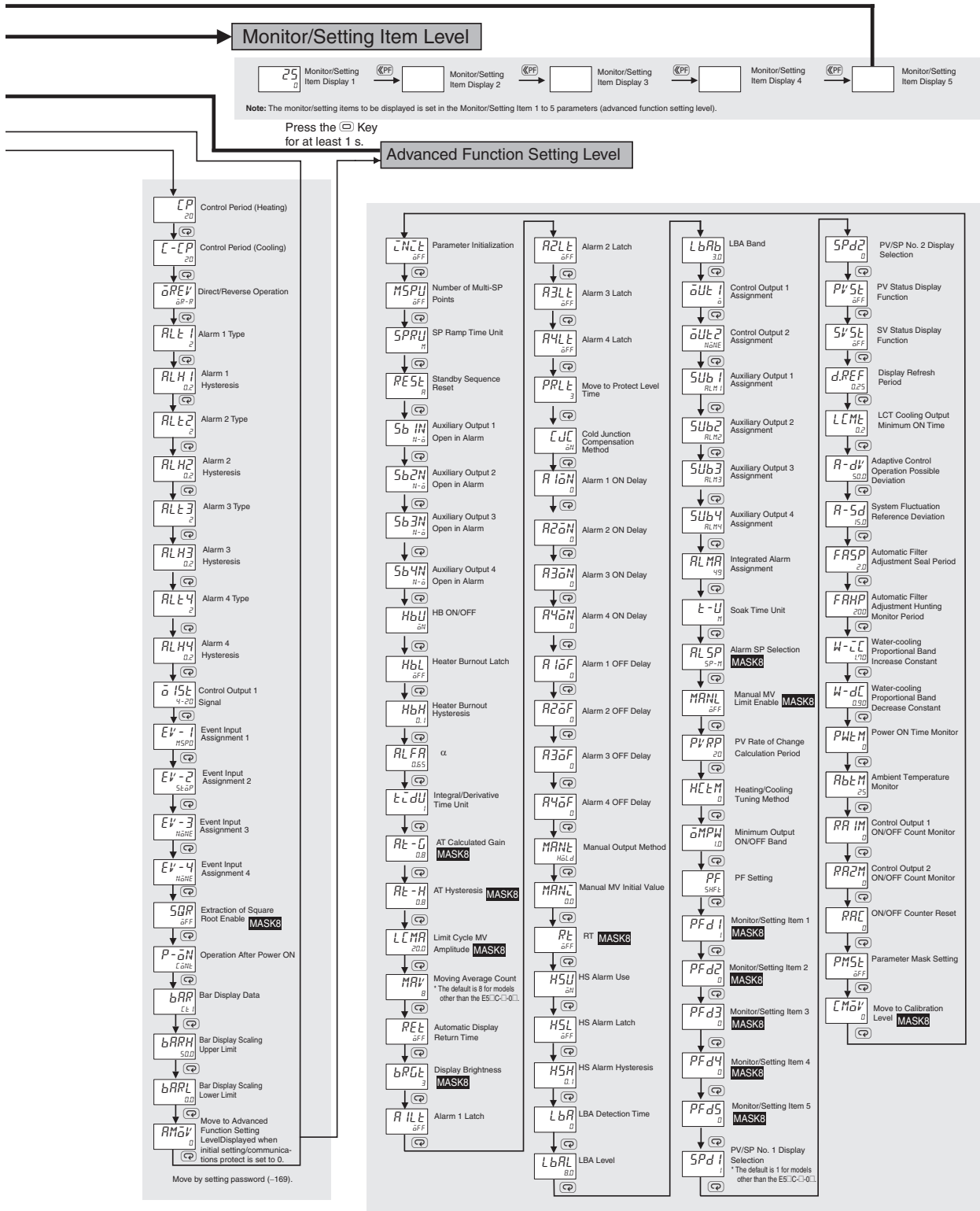



Index



Numerics

000	1-15
2-PID control	4-14, 6-43

A

AD Converter Error	A-17
Adjustment Level	6-16, A-24
Advanced Function Setting Level	6-62, A-30
air cooling/water cooling tuning	5-31
alarm delays	5-51
alarm hysteresis	4-37
alarm latches	4-38
alarm operation	4-38
alarm outputs	4-31
alarm types	4-31
alarm values	4-34
alarms	4-17
alarms (standard alarms)	1-5
analog inputs	5-27, 7-9
assigning outputs	4-16
AT (auto-tuning)	4-24
auto/manual control	5-36
auto-tuning (AT)	4-24, 6-18
auxiliary output opening and closing in alarm	4-19
auxiliary outputs 1 to 4	2-31

B

Bar Display Scaling Lower Limit	6-60
Bar Display Scaling Upper Limit	6-60

C

calibrating a current input	7-9
calibrating a voltage input	7-11
calibrating inputs	7-2
calibrating the transfer output	7-13
characteristics	A-4
checking indication accuracy	7-15
analog input	7-17
infrared temperature sensor	7-15
resistance thermometer	7-16
clearing the program end status	5-62
cold junction compensator	7-15
communications	2-35
communications operation command	5-45
Communications Setting Level	6-97, A-35
component communications	1-6, 6-98
CompoWay/F	6-98, A-35
connecting the cold junction compensator	7-5
control outputs	1-5, 4-18
control outputs 1 and 2	2-29
control periods	4-15
control ranges	A-39
controlling the start of the simple program function	5-36

CT

dimensions	
E54-CT1/CT1L	A-8
E54-CT3/CT3L	A-9
specifications	A-8
CT inputs	2-33
current transformer (CT)	4-43, A-8
Current Value Exceeds	A-18

D

dedicated protocol (format 4)	6-98, A-35
derivative time	4-30
detection current values	4-44
Digit Shift Key	3-7
dimensions	2-2
direct and reverse operation	4-15
Display Range Exceeded	A-17
Disturbance Derivative Time	6-30
Disturbance Integral Time	6-30
Disturbance Proportional Band	6-30
Down Key (☺ Key)	3-6
drawing out the interior body	2-7

E

error displays	A-16
event input assignment	5-35, 6-57
event inputs	1-6, 2-31, 5-33
extraction of square roots	5-67

F

front panel	3-4
E5CD	3-4
E5ED	3-4

H

HB alarm	4-39, A-3, A-18
heater burnout alarm	6-66, A-3
heater short alarm	4-39, A-3
heating/cooling control	5-29, 6-44
HS alarm	4-41, A-3, A-18
HS alarms	1-5

I

I/O configuration	1-7
indication ranges	A-39
infrared temperature sensor	7-15
initial setting example	
example 1	4-9
example 2	4-10
initial setting examples	4-8
Initial Setting Level	3-4, 6-40, A-26
initialization	5-84, 6-64
input digital filter	5-25
Input Error	A-16

input error	6-33
input sensor types	1-5
input type	4-11
inputs	2-28
installation	2-2
E5CD	
mounting to the Terminal Cover	2-5
E5CD, E5CD-B, and E5CD-U	
mounting to the panel	2-5
E5ED or E5AD	
mounting to the Terminal Cover	2-6
E5ED, E5ED-B, or E5AD	
mounting the Terminal Cover	2-6
insulation block diagrams	2-38
integral time	4-30
integral/derivative time unit	5-31

K

key operations	5-34
Keys	
⏴ Down Key	3-6
⏵ Level Key	3-6
⏶ Mode Key	3-6
⏷ Shift Key (PF Key)	3-6
⏸ Up Key	3-6

L

Level Key (⏵ Key)	3-6
linear tuning	5-31
logic operations	5-75
loop burnout alarm	5-53

M

main functions	1-5
manual control	5-56
Manual Control Level	6-38, A-30
manual setup	4-29
MASK8	1-15
MASK	1-15, 5-46, 6-2
MC protocol (format 4)	6-98, A-35
Memory Error	A-18
Modbus	6-98
Modbus-RTU	1-6, A-35
Mode Key (⏶ Key)	3-6
model number legends	1-8
Monitor/Setting Item Level	6-37, A-30
mounting the Terminal Covers	
E5CD	2-5
E5ED	2-6
multi-SP	5-33

N

No. 1 display	3-4, 4-46, 6-8
No. 2 display	3-4, 4-46, 6-8
No. 3 display	3-4, 4-46, 6-8

O

ON/OFF control	4-14, 4-21, 6-43
operation indicators	3-4, 3-5
Operation Level	6-7, A-23
output limits	5-65
output periods	6-49

P

panel cutout	2-4
parameter flow	A-41, A-43
parameter initialization	5-84
Parameter Mask Setting	5-46, 6-95
parameter operation lists	A-23
parameter structure	7-3
parameters	
a	6-68
Adjustment Level Display	6-18
Alarm 1 to 4 Hysteresis	6-54
Alarm 1 to 4 Latch	6-71
Alarm 1 To 4 OFF Delay	6-74
Alarm 1 to 4 ON Delay	6-73
Alarm 1 to 4 Type	4-31, 6-50
Alarm 1 to 4 Upper Limit	4-34
Alarm Lower Limit Value	4-34
Alarm SP Selection	6-83
Alarm Upper Limit Value	4-34
Alarm Value 1 to 4	4-34, 6-13
Alarm Value Lower Limit 1 to 4	6-14
Alarm Value Upper Limit 1 to 4	6-14
Alpha	6-68
AT Calculated Gain	6-69
AT Calculation Gain	4-25
AT Execute/Cancel	4-24, 6-18
AT Hysteresis	4-25, 6-69
Auto/Manual Switch	6-9
Automatic Display Return Time	6-70
Auxiliary Output 1 to 4 Assignment	4-16, 5-29, 6-81
Auxiliary Output 1 to 4 Open in Alarm	6-66
Cold Junction Compensation Method	6-72
Communications Baud Rate	6-97
Communications Data Length	6-97
Communications Parity	6-97
Communications Stop Bits	6-97
Communications Unit No.	6-97
Communications Wait Time	6-97
Communications Writing	6-19
Control Output 1 Assignment	6-80
Control Output 1 Signal	6-55
Control Output 2 Assignment	6-80
Control Period (Cooling)	6-49
Control Period (Heating)	6-49

- Dead Band 5-30, 6-30
- Decimal Point 6-42
- Derivative Time 6-26
- Derivative Time (Cooling) 4-14, 5-31, 6-27
- Digit Shift 6-86
- Direct/Reverse Operation 6-50
- Display Brightness 6-70
- Display Refresh Period 6-90
- Event Input Assignment 5-35
- Event Input Assignment 1 to 6 6-57
- event inputs 5-33
- Extraction of Square Root Enable 5-67, 6-59
- Extraction of Square Root Low-cut Point 5-67, 6-35
- HB ON/OFF 6-66
- Heater Burnout Detection 1 6-20
- Heater Burnout Hysteresis 6-67
- Heater Burnout Latch 6-67
- Heater Current 1 Value Monitor 6-10, 6-19
- Heating/Cooling Tuning Method 5-31, 6-85
- HS Alarm 1 6-21
- HS Alarm Hysteresis 6-77
- HS Alarm Latch 6-77
- HS Alarm Use 4-42, 6-76
- Hysteresis 4-21
- Hysteresis (Cooling) 6-31
- Hysteresis (Heating) 6-31
- Initial Setting/Communications Protect 6-4
- Input Type 6-41, A-26
- input type 4-11
- Integral Time 6-26
- Integral Time (Cooling) 4-14, 5-31, 6-27
- Integral/Derivative Time Unit 6-27, 6-68
- Integrated Alarm Assignment 5-49, 6-82
- LBA Band 5-54, 6-79
- LBA Detection Time 5-54, 6-78
- LBA Level 5-54, 6-78
- LCT Cooling Output Minimum ON Time 6-91
- Leakage Current 1 Monitor 6-10, 6-20
- Limit Cycle MV Amplitude 4-25, 6-69
- Loop Burnout Alarm (LBA) 5-53
- Manual Control Level 5-57
- Manual MV Initial Value 6-75
- Manual MV Limit Enable 6-84
- Manual Output Method 6-74
- Manual Reset Value 6-31
- Minimum Output ON/OFF Band 6-85
- Monitor/Setting Item 1 to 5 6-87
- Monitor/Setting Item Display 1 to 5 6-37
- Move to Advanced Function Setting Level 6-61
- Move to Calibration Level 6-96
- Move to Protect Level 6-3
- Move to Protect Level Time 6-72
- Move to the Protect Level 5-44
- Moving Average Count 5-25, 6-70
- Multi-SP Set Point Selection 6-9
- MV (Manual MV) 6-39
- MV at Error 6-33
- MV at PV Error 5-65
- MV at Stop 5-65, 6-33
- MV Change Rate Limit 5-69, 6-35
- MV Lower Limit 6-34
- MV Monitor (Cooling) 6-15
- MV Monitor (Heating) 6-15
- MV Upper Limit 6-34
- Number of Multi-SP Points 5-34, 5-38, 6-64
- Operation/Adjustment Protect 6-4
- Parameter Initialization 6-64
- Parameter Mask Enable 6-5
- password 5-44
- Password to Move to Protect Level 6-6
- PF Setting 6-37, 6-86
- PID ON/OFF 6-43
- PID ON/OFF parameter 4-22
- Process Value Input Shift 5-25
- Process Value Slope Coefficient 5-25
- Process Value/Set Point 1 6-8
- Process Value/Set Point 2 6-8
- Program Pattern 5-60, 6-48
- Program Start 6-11
- Proportional Band 6-26
- Proportional Band (Cooling) 4-14, 5-31, 6-27
- Protocol Setting 6-97
- PV Rate of Change Calculation Period 4-35, 6-84
- PV Status Display Function 6-89
- PV/MV (Manual MV) 6-39
- PV/SP Display Selection 6-8
- PV/SP No. 1 Display Selection 4-46, 6-8, 6-88
- PV/SP No. 2 Display Selection 4-46, 6-8, 6-88
- RT 6-76
- RT (Robust Tuning) 6-76
- RUN/STOP 6-12
- Scaling Lower Limit 6-42
- Scaling Upper Limit 6-42
- Set Point During SP Ramp 6-9
- Set Point Lower Limit 5-39
- Set Point Upper Limit 5-39
- Setting Change Protect 6-5
- Soak Time 5-59, 5-61, 6-32
- Soak Time Remain 6-12
- Soak Time Unit 6-83
- SP Lower Limit 6-43
- SP Ramp Fall Value 5-41, 6-34
- SP Ramp Set Value 5-41, 6-34
- SP Ramp Time Unit 6-64
- SP Upper Limit 6-43
- SP0 to SP7 6-22
- Standard or Heating/Cooling 6-44
- Standby Sequence Reset 6-65
- SV Status Display Function 6-90
- Temperature Unit 6-42
- Transfer Output Lower Limit 6-56
- Transfer Output Signal 6-55
- Transfer Output Type 5-86, 6-55
- Transfer Output Upper Limit 6-56
- Wait Band 5-61, 6-32
- Work Bit 1 to 8 OFF Delay 6-36
- Work Bit 1 to 8 ON Delay 6-36

- password 5-44, 5-45
 setting 5-45
- PF Key (⏪ Key) 3-6, 3-7, 5-44, 5-57, 5-70, 6-5
- PF setting 5-70
- PID constants 4-24, 4-26
- PID control 4-14
- potentiometer input error (Position-proportional Models Only)
 A-19
- power supply 2-28
- process value/set point 1 4-46
- process value/set point 2 4-46
- program end 5-62
- program end output 5-62
- programless communications 1-6
- proportional action 4-29
- proportional band 4-30
- Protect Level 6-3, A-35
- protection 5-43
 Initial Setting/Communications Protect 5-43
 Operation/Adjustment Protect 5-43
 PF Key Protect 5-44
 Setting Change Protect 5-44
- Push-In Plus terminal blocks 2-25
- PV change rate alarm 4-35
- PV status display 5-73
- ## R
-
- ratings A-2
- registering calibration data 7-2
- resistance thermometer calibration 7-7
- RS-485 2-35, A-5
- run/stop control 5-36
- ## S
-
- sampling cycle 4-35, A-5
- sensor input setting ranges A-39
- set point limiter 5-39
- set points 0 to 7 6-9
- setting levels diagram A-40
- setting monitor/setting items 5-72
- setting output specifications 4-15
- setting the input type 4-11
- setting the set point (SP) 4-20
- setting the SP upper and lower limit values 5-39
- Setup Tool ports 2-39, 2-40, 3-7
- Shift Key (⏩ Key) 3-7
- shifting input values 5-25
- shifting inputs 5-25
- simple program function 5-59
 starting method 5-60
- SP ramp 5-41
 alarms 5-42
 operation at startup 5-42
 restrictions 5-42
- SP Response Derivative Time 6-28
- SP Response Integral Time 6-28
- SP Response Proportional Band 6-28
- SP0 to SP7 5-33
- specifications A-2
- standard control 6-44
- standby sequences 4-37
- SV status display 5-73
- ## T
-
- temperature unit 4-13
- terminal arrangement 2-9
- terminal block wiring examples
 E5CD 2-9
 E5CD-B 2-13
 E5ED 2-17
 E5ED-B 2-21
- thermocouple calibration 7-4
- thermocouple or infrared temperature sensor 7-15
- three-position control 5-32
- transfer output 5-86
- transfer output signal 5-86
- transfer scaling 5-87
- troubleshooting A-20
- ## U
-
- Up Key (⏴ Key) 3-6
- USB-Serial Conversion Cable 2-39, 2-41, A-11
- user calibration 7-2
- using the terminals 2-9
- ## V
-
- versions 1-13
- ## W
-
- wiring 2-28
- wiring precautions 2-25
- work bit 1 to 8 5-78

OMRON Corporation Industrial Automation Company

Kyoto, JAPAN

Contact : www.ia.omron.com

Regional Headquarters

OMRON EUROPE B.V.

Wegalaan 67-69, 2132 JD Hoofddorp
The Netherlands

Tel: (31) 2356-81-300 Fax: (31) 2356-81-388

OMRON ASIA PACIFIC PTE. LTD.

438B Alexandra Road, #08-01/02 Alexandra
Technopark, Singapore 119968

Tel: (65) 6835-3011 Fax: (65) 6835-2711

OMRON ELECTRONICS LLC

2895 Greenspoint Parkway, Suite 200
Hoffman Estates, IL 60169 U.S.A.

Tel: (1) 847-843-7900 Fax: (1) 847-843-7787

OMRON (CHINA) CO., LTD.

Room 2211, Bank of China Tower,
200 Yin Cheng Zhong Road,
PuDong New Area, Shanghai, 200120, China

Tel: (86) 21-5037-2222 Fax: (86) 21-5037-2200

Authorized Distributor:

©OMRON Corporation 2017-2022 All Rights Reserved.
In the interest of product improvement,
specifications are subject to change without notice.

Cat. No. H224-E1-04

0922