



CJ Series
EtherCAT[®] Connection Guide

OMRON Corporation
E3NW-ECT Digital Sensor Communication Unit

About Intellectual Property Right and Trademarks

Microsoft product screen shots reprinted with permission from Microsoft Corporation.

Windows is a registered trademark of Microsoft Corporation in the USA and other countries.

Ethernet is a registered trademark of Xerox Corporation.

EtherCAT® is registered trademark and patented technology, licensed by Beckhoff Automation GmbH, Germany.

Company names and product names in this document are the trademarks or registered trademarks of their respective companies.

Table of Contents

1. Related Manuals	1
2. Terms and Definitions	1
3. Remarks	2
4. Overview	3
5. Applicable Devices and Support Software.....	3
5.1. Applicable Devices.....	3
5.2. Device Configuration.....	4
6. EtherCAT Settings	6
6.1. EtherCAT Communications Settings	6
6.2. DS-Bus Communication Settings.....	6
6.3. Allocations of I/O Memory Areas.....	8
7. Connection Procedure	10
7.1. Work Flow	10
7.2. Setting Up the Digital Sensor Communication Unit.....	11
7.3. Setting Up the PLC	13
7.4. Checking the EtherCAT Communications	23
8. Initialization Method.....	29
8.1. Initializing the PLC	29
9. Revision History	31

1. Related Manuals

The table below lists the manuals related to this document.

To ensure system safety, make sure to always read and heed the information provided in all Safety Precautions, Precautions for Safe Use, and Precaution for Correct Use of manuals for each device which is used in the system.

Cat. No.	Model	Manual name
W472	CJ2H-CPU6[]-EIP CJ2H-CPU6[] CJ2M-CPU[]	CJ-series CJ2 CPU Unit Hardware User's Manual
W473	CJ2H-CPU6[]-EIP CJ2H-CPU6[] CJ2M-CPU[]	CJ-series CJ2 CPU Unit Software User's Manual
W487	CJ1W-NC[]82	CJ-series Position Control Unit Operation Manual
W446	-	CX-Programmer Operation Manual
E429	E3NW-ECT E3NW-DS	EtherCAT® Digital Sensor Communication Unit Operation Manual



2. Terms and Definitions

Term	Explanation and Definition
Position Control Unit	The Position Control Unit controls Servo Drives. This Position Control Unit has two EtherCAT Functions: Communications for Servo Drive control and Remote I/O master function.
Communications for Servo Drive control	This function performs monitoring, setting and control when G5-series Servo Drives are connected.
Remote I/O master function	This function updates the I/O data in the memory area allocated to the connected slave units and PLC during each I/O refresh of the PLC when compatible devices other than G5-series Servo Drives are connected.
Slave unit	There are various types of slave units such as Servo Drives that handle process data and I/O terminals that handle the bit signals. The slave unit receives output data sent from the master, and transmits input data to the master.
Node address	An address to identify the unit connected to EtherCAT. This Position Control Unit uses the node addresses 1 to 16 for G5-series Servo Drives and node addresses 17 onwards for other slave units (e.g., remote I/O).

3. Remarks

- (1) Understand the specifications of devices which are used in the system. Allow some margin for ratings and performance. Provide safety measures, such as installing safety circuit in order to ensure safety and minimize risks of abnormal occurrence.
- (2) To ensure system safety, always read and heed the information provided in all Safety Precautions, Precautions for Safe Use, and Precaution for Correct Use of manuals for each device used in the system.
- (3) The users are encouraged to confirm the standards and regulations that the system must conform to.
- (4) It is prohibited to copy, to reproduce, and to distribute part or the whole of this document without the permission of OMRON Corporation.
- (5) The information contained in this document is current as of June 2013. It is subject to change without notice for improvement.

The following notation is used in this document.

 WARNING	Indicates a potentially hazardous situation which, if not avoided, will result in minor or moderate injury, or may result in serious injury or death. Additionally there may be significant property damage.
 Caution	Indicates a potentially hazardous situation which, if not avoided, may result in minor or moderate injury or in property damage.



Precautions for Safe Use

Precautions on what to do and what not to do to ensure safe usage of the product.



Precautions for Correct Use

Precautions on what to do and what not to do to ensure proper operation and performance.



Additional Information

Additional information to read as required.

This information is provided to increase understanding or make operation easier.

Symbols



The triangle symbol indicates precautions (including warnings).
The specific operation is shown in the triangle and explained in text.
This example indicates a general precaution.

4. Overview

This document describes the procedure for connecting the Digital Sensor Communication Unit (E3NW-ECT) of OMRON Corporation (hereinafter referred to as OMRON) to CJ-series Programmable Controller + Position Control Unit (hereinafter referred to as the PLC) and provides the procedure for checking their connection.

Refer to EtherCAT settings described in 7. Connection Procedure to understand the setting method and key points to connect the devices via EtherCAT.

5. Applicable Devices and Support Software

5.1. Applicable Devices

The applicable devices are as follows:

Manufacturer	Name	Model
OMRON	CJ2 CPU Unit	CJ2[]-CPU[]
OMRON	Position Control Unit	CJ1W-NC[]82
OMRON	Digital Sensor Communication Unit	E3NW-ECT
OMRON	Distributed Sensor Unit	E3NW-DS
OMRON	Sensor Amplifiers Smart Fiber Amplifier Smart Laser Amplifier Unit Smart Laser Amplifier Unit (CMOS Type)	E3NX-FA0 E3NC-LA0 E3NC-SA0



Precautions for Correct Use

As applicable devices above, the devices with the models and versions listed in Section 5.2. are actually used in this document to describe the procedure for connecting devices and checking the connection.

You cannot use devices with versions lower than the versions listed in Section 5.2.

To use the above devices with versions not listed in Section 5.2 or versions higher than those listed in Section 5.2, check the differences in the specifications by referring to the manuals before operating the devices.



Additional Information

This document describes the procedure to establish the network connection. Except for the connection procedure, it does not provide information on operation, installation or wiring method. It also does not describe the functionality or operation of the devices. Refer to the manuals or contact your OMRON representative.

5.2. Device Configuration

The hardware components to reproduce the connection procedure of this document are as follows.

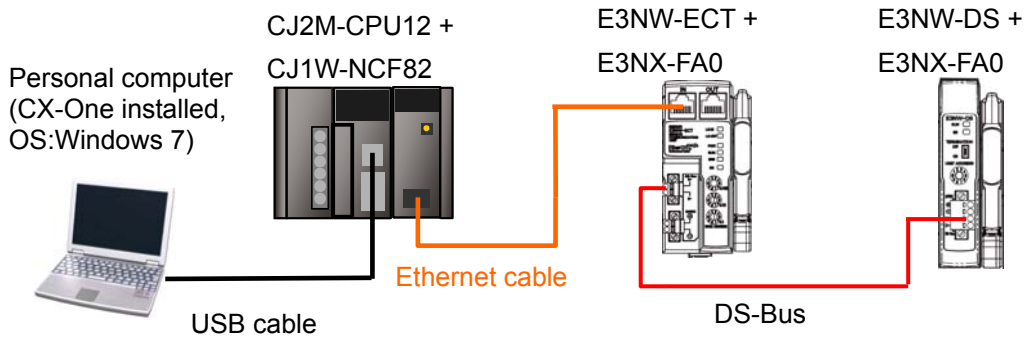

Manufacturer	Name	Model	Version
OMRON	Position Control Unit	CJ1W-NCF82	Ver.1.3
OMRON	CPU Unit	CJ2M-CPU12	Ver.2.0
OMRON	Power Supply Unit	CJ1W-PA202	
OMRON	CX-One	CXONE-AL□□C-V4 /AL□□D-V4	Ver.4.□□
OMRON	CX-Programmer	(Included in CX-One)	Ver.9.43
-	Personal computer (OS: Windows7)	-	
-	USB cable	-	
OMRON	Ethernet cable (with industrial Ethernet connector)	XS5W-T421-□M□-K	
OMRON	Digital Sensor Communication Unit	E3NW-ECT	Ver.1.0
OMRON	Distributed Sensor Unit	E3NW-DS	Ver.1.0
OMRON	Fiber Amplifier	E3NX-FA0	Ver.1.0
-	DS-Bus communications cable	-	

Precautions for Correct Use

The connection line of EtherCAT communication cannot be shared with other Ethernet networks.

Make sure to directly connect the PLC to the destination device with the Ethernet cable.

Please use the cable (double shielding with aluminum tape and braiding) of Category 5 or higher, and use the shielded connector of Category 5 or higher.

Precautions for Correct Use

Update the CX-Programmer to the version specified in this section or higher version using the auto update function.

If a version not specified in this section is used, the procedures described in Section 7 and subsequent sections may not be applicable. In that case, use the equivalent procedures described in the CX-Programmer Operation Manual (Cat. No. W466).



Additional Information

For information on the specifications of the Ethernet cable and network wiring, refer to 3-4 *Wiring of the CJ-series Position Control Unit Operation Manual* (Cat. No. W487).



Additional Information

The system configuration in this document uses USB for the connection between the personal computer and PLC. For information on how to install the USB driver, refer to A-5 *Installing the USB Driver* in the *CJ-series CJ2 CPU Unit Hardware User's Manual* (Cat. No. W472).



Additional Information

For details on the Inter-Unit DS-Bus network, refer to A-2 *Using Distributed Sensor Units of the EtherCAT® Digital Sensor Communication Unit Operation Manual* (Cat. No. E429).

6. EtherCAT Settings

This section describes the procedure for connecting the PLC to the Digital Sensor Communication Unit via EtherCAT.

6.1. EtherCAT Communications Settings

The settings required for communications between the PLC (Position Control Unit) and the Digital Sensor Communication Unit are given below.

6.1.1. EtherCAT Communications Setting Contents

The settings required for EtherCAT communications are given below.

	PLC (Position Control Unit)	Digital Sensor Communication Unit
Unit number	0	-
Node address	-	017



Additional Information

The node addresses 17 onwards are set for CJ1W-NC[]82 when EtherCAT-compatible devices other than G5-series Servo Drives are connected.

6.2. DS-Bus Communication Settings

The setting required for communications between the Digital Sensor Communication Unit and the Distributed Sensor Unit is given below.

6.2.1. DS-Bus Communication Setting Contents

The settings required for communications through the Inter-Unit DS-Bus network are given below.

	Distributed Sensor Unit
Unit address	1
Termination setting	ON

*The Sensor unit numbers are automatically assigned after turning ON the power supply to the Digital Sensor Communication Unit and to the Distributed Sensor Unit.

In this document, one Fiber Amplifier is connected to the Digital Sensor Communication Unit and another one to the Distributed Sensor Unit. The Sensor unit number 1 is assigned to the Fiber Amplifier that is connected to the Digital Sensor Communication Unit, and the Sensor unit number 2 is assigned to the Fiber Amplifier connected to the Distributed Sensor Unit.



Additional Information

For details on the Inter-Unit DS-Bus network, refer to *A-2 Using Distributed Sensor Units of the EtherCAT® Digital Sensor Communication Unit Operation Manual* (Cat. No. E429).

6.2.2. Cable Wiring Diagram

For details on the cable wiring, refer to A-2-3 DS-Bus Network Wiring of the EtherCAT® Digital Sensor Communication Unit Operation Manual (Cat. No. E429). Check the connector configuration and pin assignment for wiring.

•Connector configuration and pin assignment

<OMRON E3NW-ECT> Applicable connector: Terminal-block connector

Pin No	Name	Description	I/O
1	D+	D+ terminal	I/O
2	D-	D- terminal	I/O

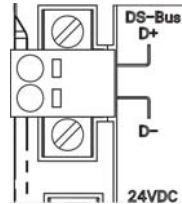

<OMRON E3NW-DS> Applicable connector: Terminal-block connector

Pin No	Name	Description	I/O
1	+	+V terminal	-
2	-	-V terminal	-
3	D+	D+ terminal	I/O
4	D-	D- terminal	I/O

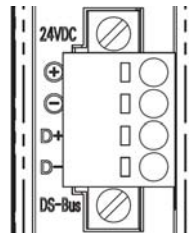

•Cable/Pin arrangement

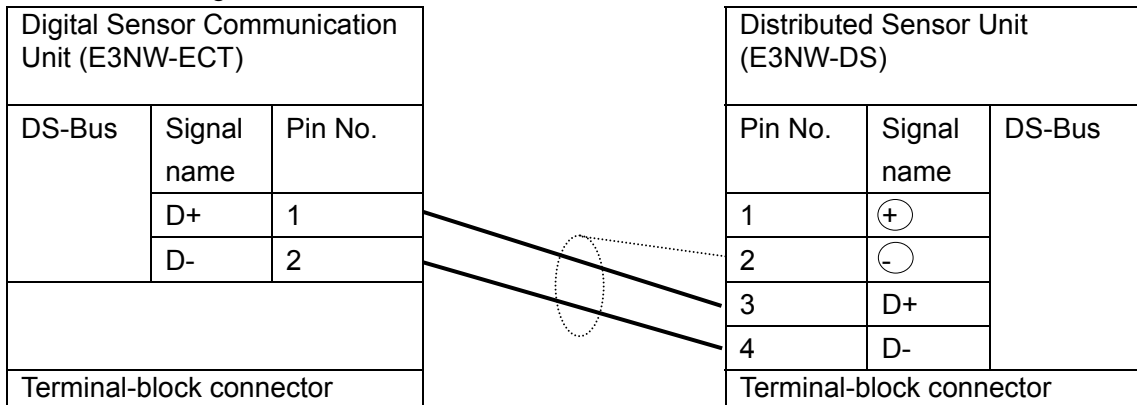

Additional Information

For details on the recommended cables and ferrules, refer to A-2-3 DS-Bus Network Wiring of the EtherCAT® Digital Sensor Communication Unit Operation Manual (Cat. No. E429).

6.3. Allocations of I/O Memory Areas

The I/O allocations of the Digital Sensor Communication Unit are as follows:

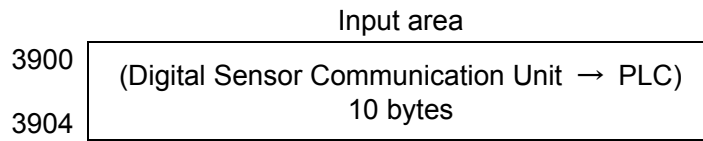

▪Details on output area

No output area is allocated.

▪Details on input area

Address	Bit	Function name	Description
3900	15 to 0	Read input 1st word	Sensor unit No. 1 Sensor Input 1 Sensor unit No. 1 Sensor Input 2 Sensor unit No. 8 Sensor Input 1 Sensor unit No. 8 Sensor Input 2
3901	15 to 0	Read input 2nd word	Sensor unit No. 9 Sensor Input 1 Sensor unit No. 9 Sensor Input 2 Sensor unit No. 16 Sensor Input 1 Sensor unit No. 16 Sensor Input 2
3902	7 to 0	Sensor Status bits	Sensor status
	15 to 8	Connecting Sensor bits	Number of Sensors setting (register at power-on)
3903	7 to 0		Number of Sensors setting with dummy
	15 to 8	Sensor Status 16 bits	Warning status (Sensor unit No. 1 to 8)
3904	7 to 0	Reserved	Warning status (Sensor unit No. 9 to 16)
	15 to 8		Reserved

•Read input 1st word

3900	15	14	13	12	11	10	9	8	7	6	5	4	3	2	1	0
	Sensor 8		Sensor 7		Sensor 6		Sensor 5		Sensor 4		Sensor 3		Sensor 2		Sensor 1	
	IN2	IN1	IN2	IN1	IN2	IN1	IN2	IN1	IN2	IN1	IN2	IN1	IN2	IN1	IN2	IN1

•Read input 2nd word

3901	15	14	13	12	11	10	9	8	7	6	5	4	3	2	1	0
	Sensor 16		Sensor 15		Sensor 14		Sensor 13		Sensor 12		Sensor 11		Sensor 10		Sensor 9	
	IN2	IN1	IN2	IN1	IN2	IN1	IN2	IN1	IN2	IN1	IN2	IN1	IN2	IN1	IN2	IN1

•Sensor Status bits

3902	15	14	13	12	11	10	9	8	7	6	5	4	3	2	1	0
	(Number of Sensors setting)									0	0	0	0	0	0	S_ERR

•Sensor Status(Warning Status) 16 bits

3903	15	14	13	12	11	10	9	8	7	6	5	4	3	2	1	0
	Sensor unit No.								(Number of Sensors)							
3904	7	6	5	4	3	2	1	0	Sensor unit No.							
	(Reserved)								15	14	13	12	11	10	9	8



Additional Information

The default first words of the Remote I/O Output Memory Area and the Remote I/O Input Memory Area are CIO 3800 and CIO 3900, respectively.

For how to change the allocations of the Remote I/O Memory Areas, refer to *6-3 Common Parameters* of the *CJ-series Position Control Unit Operation Manual* (Cat. No. W487).



Additional Information

For details on the PDO mapping of the Digital Sensor Communication Unit, refer to *5-4-4 PDO Mapping* of the *EtherCAT® Digital Sensor Communication Unit Operation Manual* (Cat. No. E429).

7. Connection Procedure

This section describes the procedure for connecting the PLC to the Digital Sensor Communication Unit via EtherCAT.

This document explains the procedure for setting up the PLC and the Digital Sensor Communication Unit from the factory default setting. For the initialization, refer to *Section 8 Initialization Method*.

7.1. Work Flow

Take the following steps to connect to the Digital Sensor Communication Unit via EtherCAT.

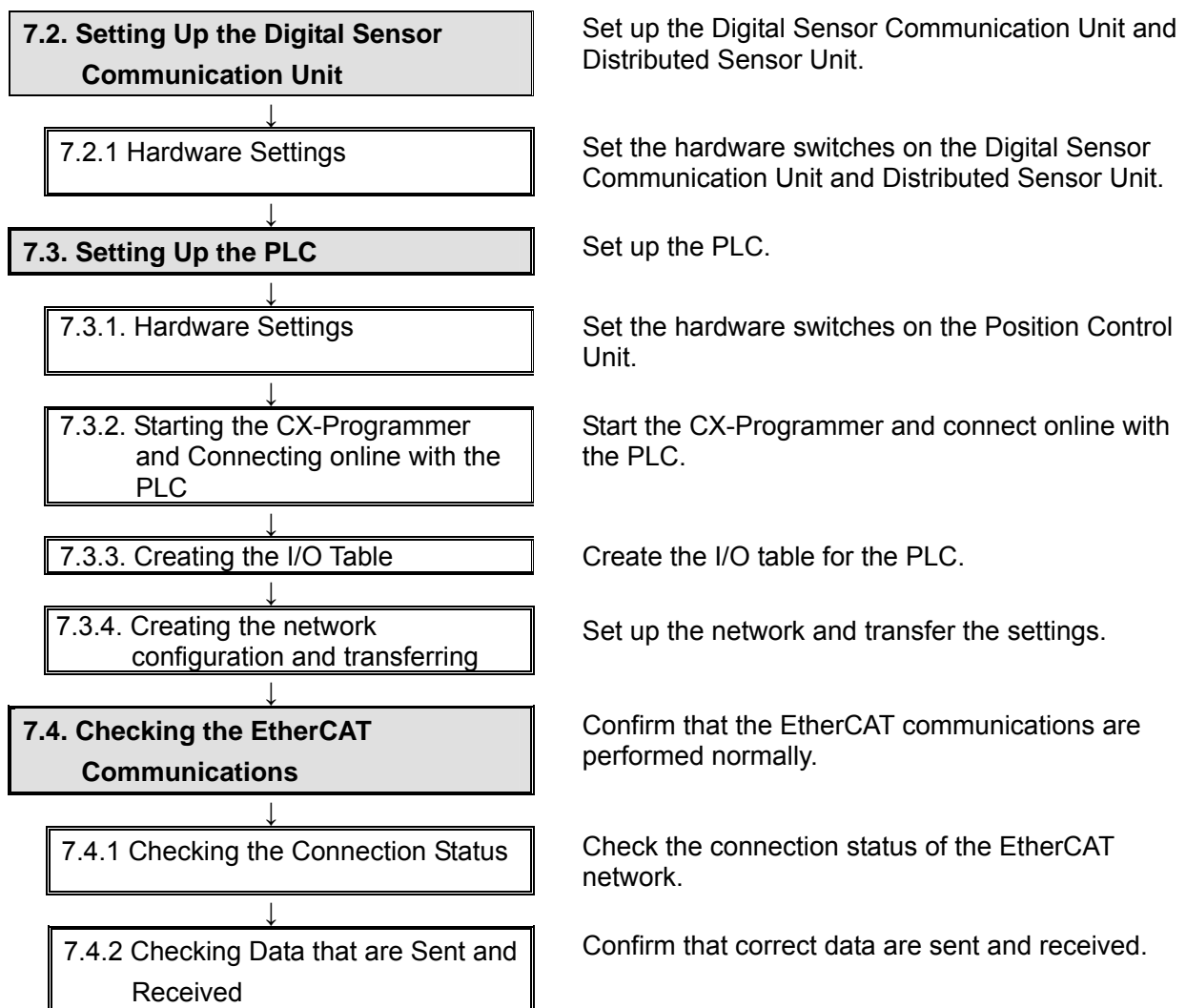

7.2. Setting Up the Digital Sensor Communication Unit

Set Up the Digital Sensor Communication Unit.

7.2.1. Hardware Settings

Set the hardware switches on the Digital Sensor Communication Unit.



Precautions for Correct Use

Make sure that the power supply is OFF when you perform the setting up.

- 1 Confirm that the power supply to the Digital Sensor Communication Unit is OFF.

*If the power supply is turned ON, settings may not be applicable as described in the following procedure.

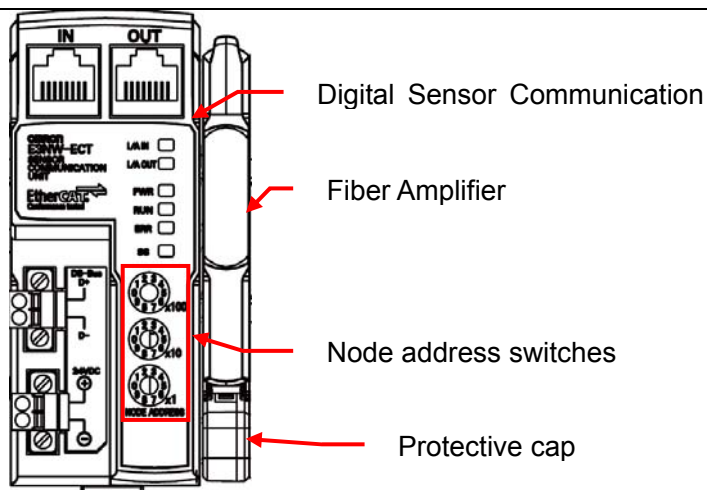

- 2 Connect the Digital Sensor Communication Unit to the Fiber Amplifier, and attach the protective cap. Check the hardware switches on the Digital Sensor Communication Unit by referring to the figure on the right.

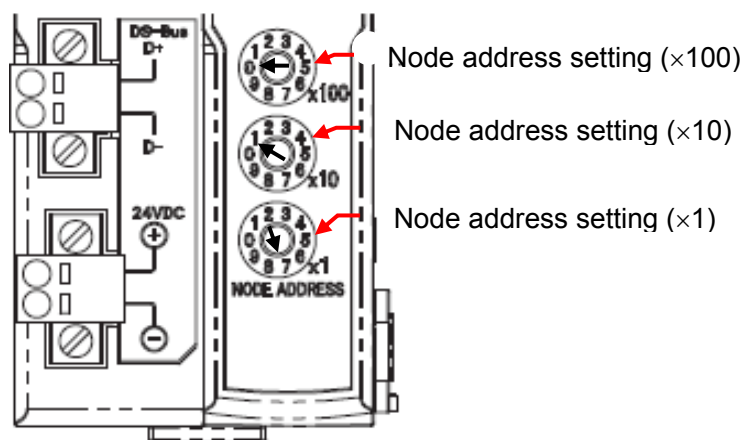

- 3 Set the node address switches as follows.
 ×100: 0
 ×10: 1
 ×1: 7

*Set the node address to 017.

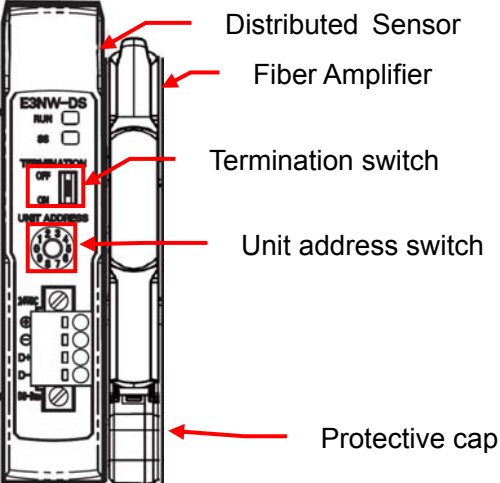

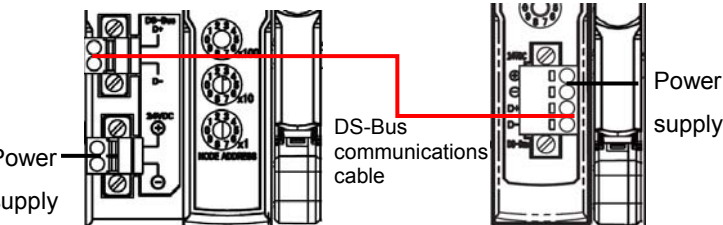
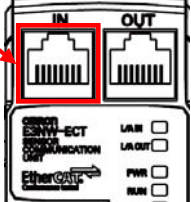
<p>4</p>	<p>Connect the Distributed Sensor Unit to the Fiber Amplifier, and attach the protective cap. Check the hardware switches on the Distributed Sensor Unit by referring to the figure on the right.</p>	 <p>Distributed Sensor Fiber Amplifier Termination switch Unit address switch Protective cap</p>
<p>5</p>	<p>Set the termination switch to ON.</p>	 <p>Termination switch</p> <p>This switch turns ON and OFF the communications terminating resistance on the Inter-Unit DS-Bus network. Turn ON the DS-Bus termination switch only on the last Distributed Sensor Unit on the DS-Bus network. Turn it OFF on all other Distributed Sensor Units.</p>
<p>6</p>	<p>Set the unit address switch to 1. *Set the unit address to 1.</p>	 <p>Unit address setting</p> <p>This switch sets the node address (decimal) that the E3NW-DS will use on the Inter-Unit DS-Bus network. The setting range is from 1 to 8. (Default setting: 1) If you connect more than one Distributed Sensor Unit to the Sensor Communication Unit, set the address for each Distributed Sensor Unit to consecutive numbers starting from 1.</p>
<p>7</p>	<p>Connect the Digital Sensor Communication Unit to the Distributed Sensor Unit with the DS-Bus communications cable. *For the wiring of the DS-Bus communications cable, refer to 6.2.2. Cable Wiring Diagram.</p>	 <p>Power supply DS-Bus communications cable Power supply</p>
<p>8</p>	<p>Connect the Ethernet cable to CN IN connector. Turn ON the power supply. Unit numbers are assigned to the Fiber Amplifier as follows after turning ON the power supply. Digital Sensor Communication Unit: Sensor unit No. 1 Distributed Sensor Unit: Sensor unit No. 2</p>	 <p>CN IN connector</p>

7.3. Setting Up the PLC

Set up the PLC.

7.3.1. Hardware Settings

Set the hardware switches on the Position Control Unit.



Precautions for Correct Use

Make sure that the power supply is OFF when you perform the setting up.

- 1 Make sure that the power supply to the PLC is OFF.

*If the power supply is turned ON, settings may not be applicable as described in the following procedure.

- 2 Check the hardware switches on the front panel of the Position Control Unit by referring to the right figure.

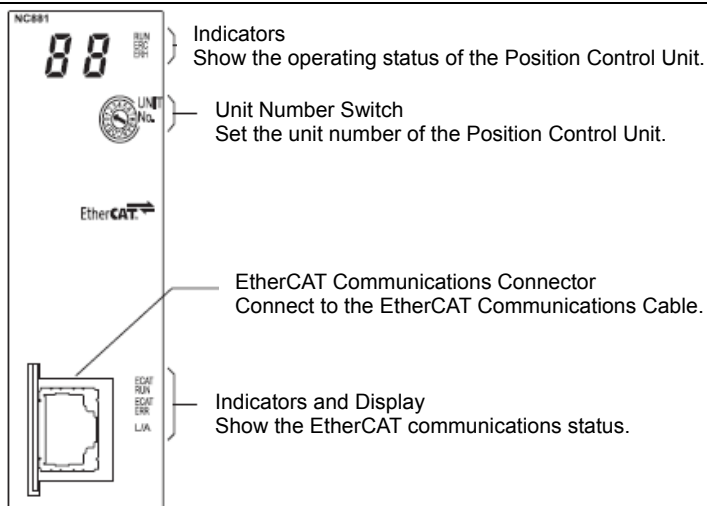

- 3 Set the Unit No. Switch to 0.

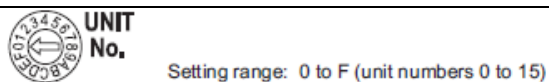

Note: The unit number is factory-set to 0.

- 4 Connect each PLC unit in order from the Power Supply Unit, CPU Unit, Position Control Unit and End Cover.

Connect the Ethernet cable to the Position Control Unit and connect the USB cable to the CPU Unit.

After connecting, turn ON the power supply to the PLC.

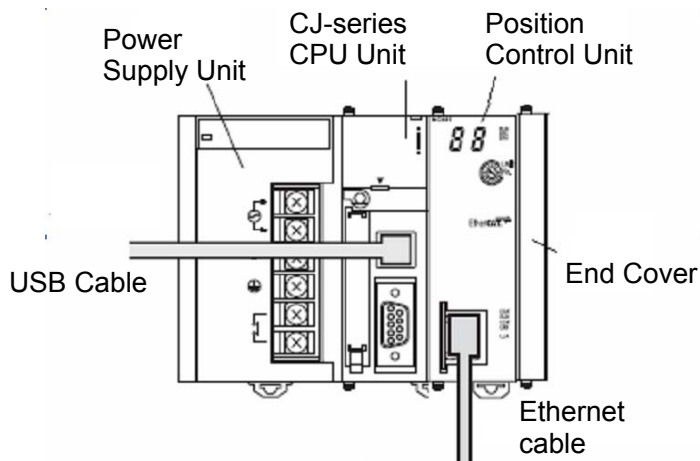



7.3.2. Starting the CX-Programmer and Connecting Online with the PLC

Start the CX-Programmer and Connect Online with the PLC.

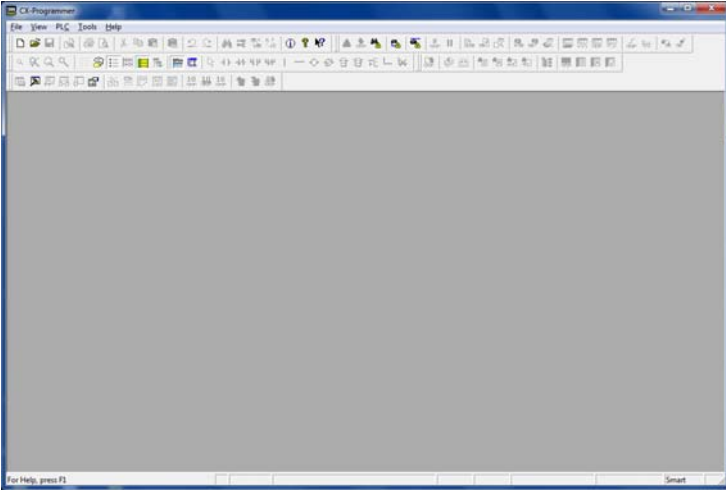
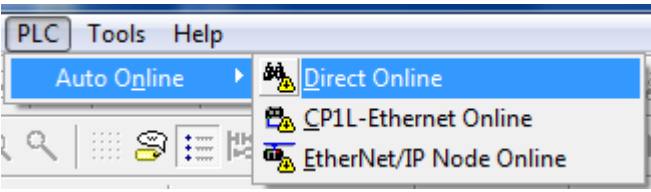
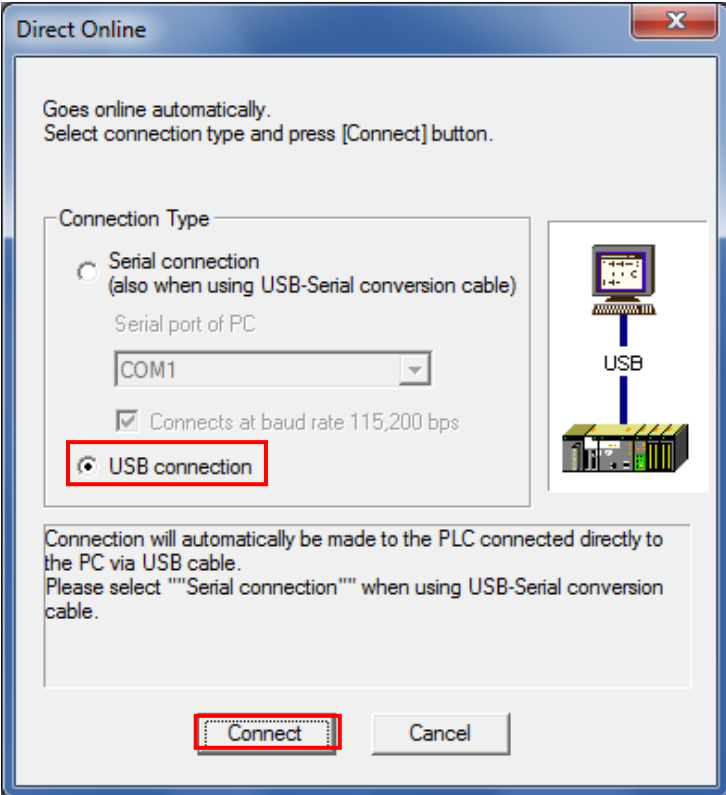
Install the CX-One and USB driver in the personal computer beforehand.

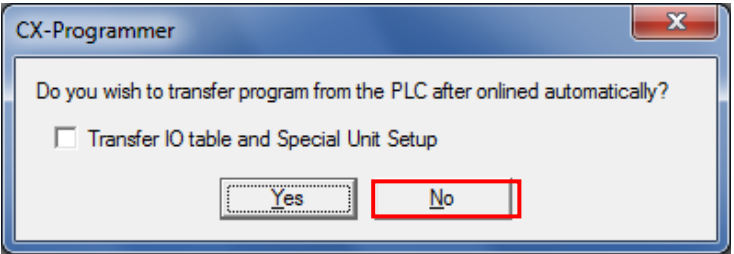
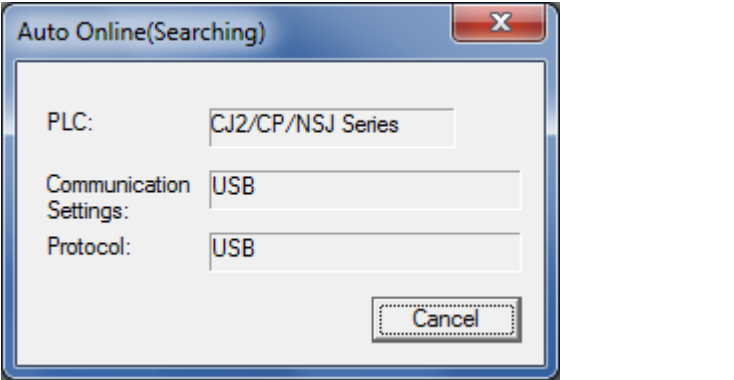
1	Start the CX-Programmer.	
2	Select Auto Online - Direct Online from the PLC Menu.	
3	The Direct Online Dialog Box is displayed. Select the USB Connection Option for Connection Type and click the Connect Button.	

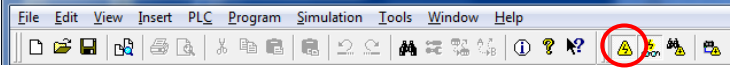
<p>4 The dialog box on the right is displayed. Check the message on the dialog and if there is no problem, click the No Button.</p>	
<p>5 The dialog box on the right is displayed, and the CX-Programmer and the PLC is automatically connected.</p>	
<p>6 Confirm that the CX-Programmer and the PLC are normally connected online.</p> <p>*The  icon is shown during online connection.</p>	



Additional Information

If the CX-Programmer and PLC are not connected online, please check the connection of the cable. Or, return to step 2, check the settings and repeat each step.

Refer to *Connecting Directly to a CJ2 CPU Unit Using a USB Cable* in *Chapter 3 Communications* in *PART 3: CX-Server Runtime* of the *CX-Programmer Operation Manual* (Cat. No. W466) for details.



Additional Information

The dialogs explained in the following procedures may not be displayed depending on the environmental setting of CX-Programmer.

For details on the environmental setting, refer to *Options and Preferences* in *Chapter 3 Project Reference* in *PART 1: CX-Programmer* of the *CX-Programmer Operation Manual* (Cat. No. W466). This document explains the setting procedure when the Confirm all operations affecting the PLC Check Box is selected.

7.3.3. Creating the I/O Table

Create the I/O table for the PLC.

- 1 If the operating mode of the PLC is RUN Mode or Monitor Mode, change it to Program Mode, by following steps (1) to (3).

(1) Select **Operating Mode - Program** from the PLC Menu of the CX-Programmer.

(2) The dialog box on the right is displayed. Check the message on the dialog and if there is no problem, click the **Yes** Button.

*Refer to *Additional Information* in 7.3.2. *Starting the CX-Programmer and Connecting Online with the PLC* for the settings concerning the dialog display.

(3) Confirm that Stop/Program Mode is displayed on the right of the PLC model in the project workspace of the CX-Programmer.

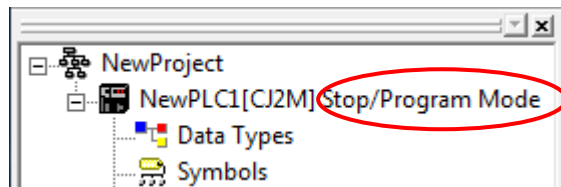
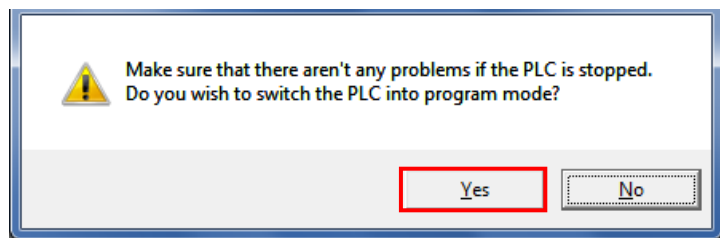
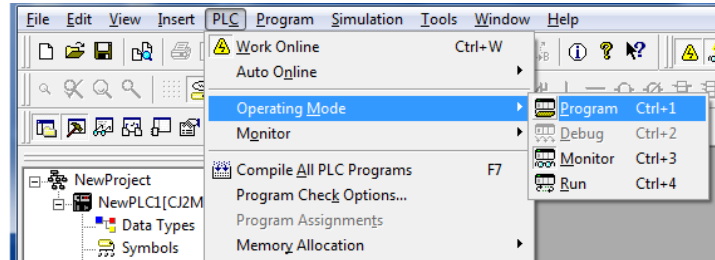
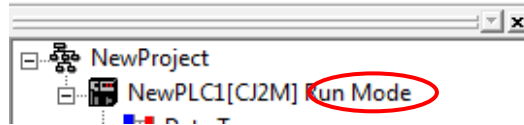

- 2 Select **Edit - I/O Table and Unit Setup** from the PLC Menu of the CX-Programmer.

The PLC IO Table Window is displayed.

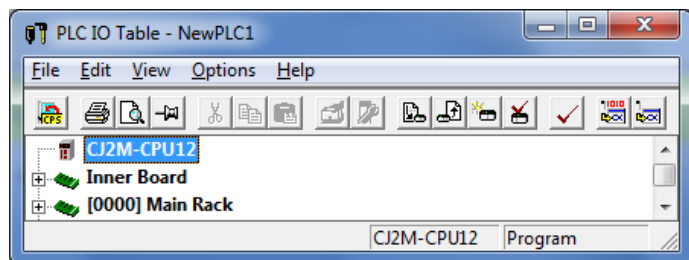
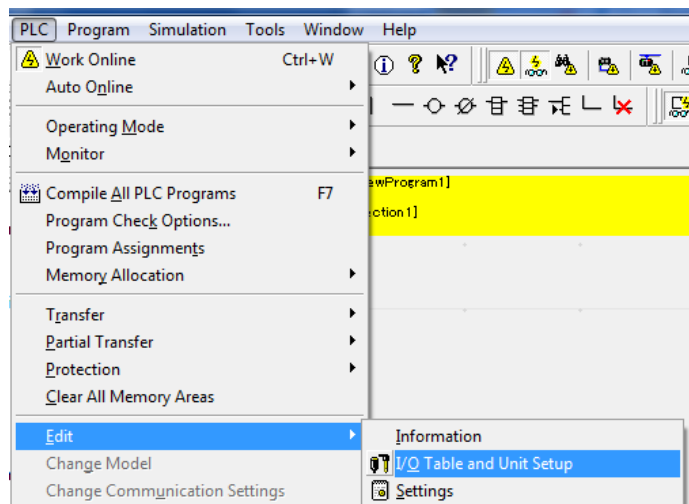

3 Select **Create** from the Options Menu of the PLC IO Table Window.

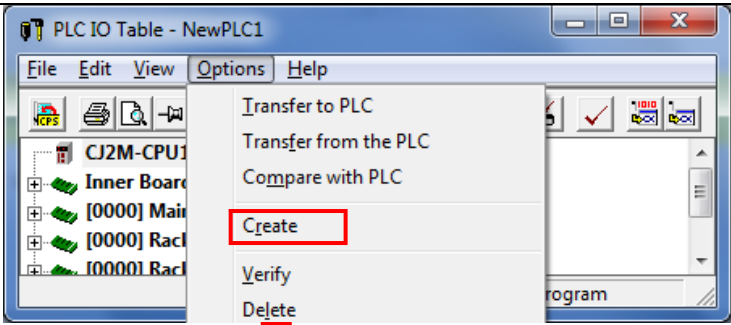

The dialog box on the right is displayed. Check the message on the dialog and if there is no problem, click the **Yes** Button.

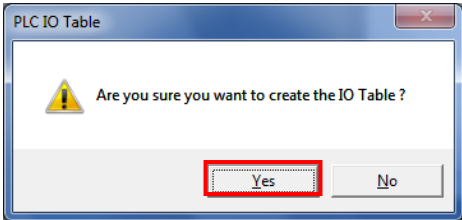

The dialog box on the right is displayed. Check the message on the dialog and if there is no problem, click the **Yes** Button.

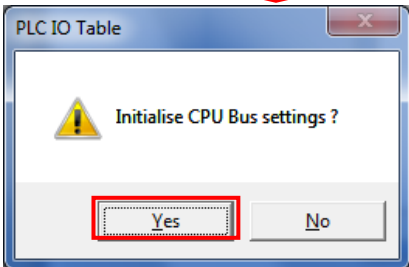

4 The Transfer from PLC Dialog Box is displayed. Select the *I/O Table* Check Box and the *SIO Unit Parameters* Check Box, and click the **Transfer** Button.

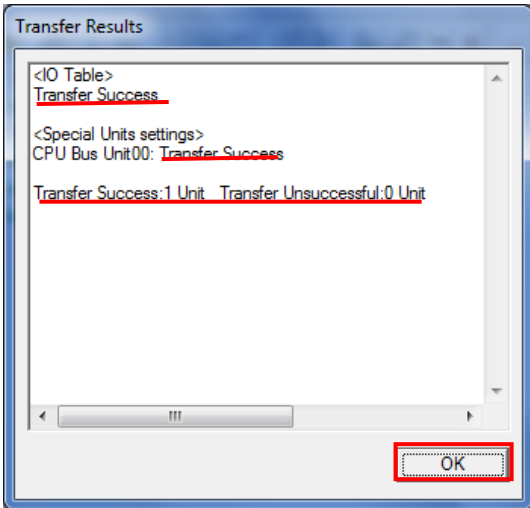
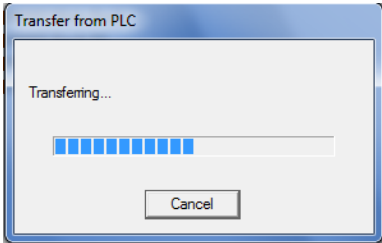
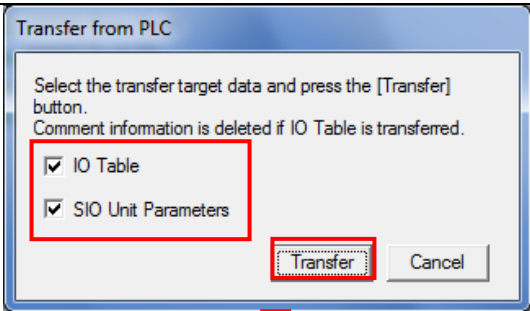

The Transfer from PLC Dialog Box is displayed.

Confirm that the transfer was normally executed by checking the message in the dialog box.

When the I/O table is created normally, the dialog box shows the following:

Transfer Success: 1 Unit
Transfer Unsuccessful: 0 Unit

Click the **OK** Button.

 **Precautions for Correct Use**

Confirm that the Ethernet cable is connected before proceeding to the following procedure. If it is not connected, turn OFF the power supply to each device, and then connect the Ethernet cable.

7.3.4. Creating the Network Configuration and Transferring

Create the network configuration and transfer the settings.

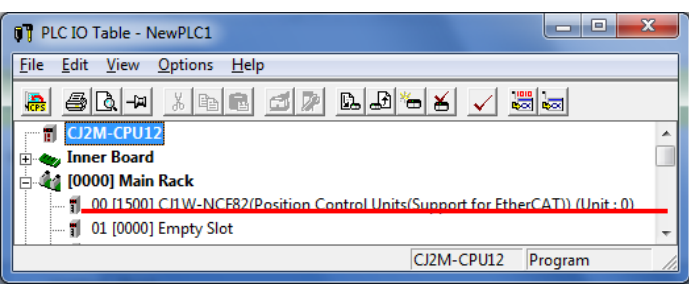
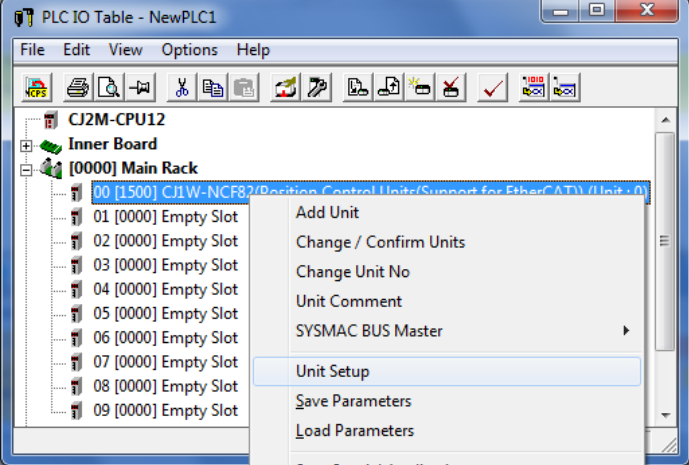
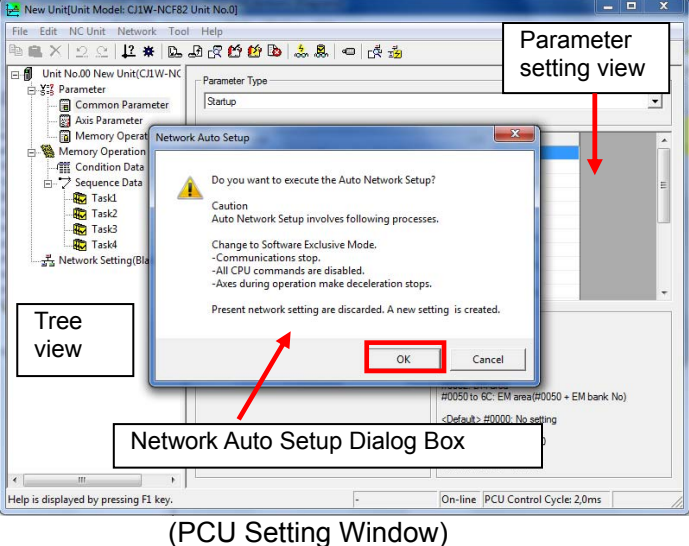
<p>1 Double-click the [0000] Main Rack on the PLC IO Table Window to expand the tree.</p>	
<p>2 Right-click 00[1500]CJ1W-NCF82 and select the Unit Setup.</p>	
<p>3 The Network Auto Setup Dialog Box is displayed. Check the message on the dialog and if there is no problem, click the OK Button.</p> <p>*If the dialog box is not displayed, select Network Auto Setup from the Network Menu in the PCU Setting Window.</p> <p>*Close any other dialog box such as the Monitor Dialog Box if displayed.</p>	 <p style="text-align: center;">(PCU Setting Window)</p>



Additional Information

The node addresses 17 onwards are set for CJ1W-NC[82] in order from the addresses that were set when EtherCAT-compatible devices other than G5-series Servo Drives are connected.

4 The dialog box on the right is displayed. Select the *Fixed Allocations* Option and click the **OK** Button.

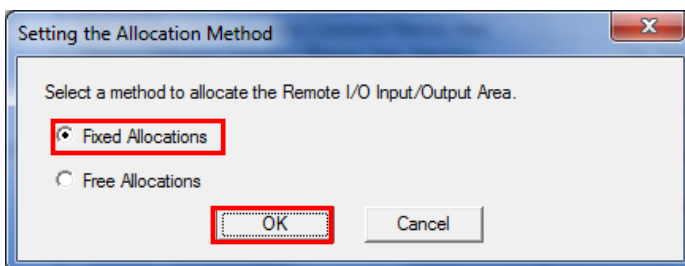

5 The network configuration is set up automatically. Confirm that the node address 17 is set for *E3NW-ECT Communication Unit for Digital Type Sensor 60 inputs*, and click the **OK** Button.

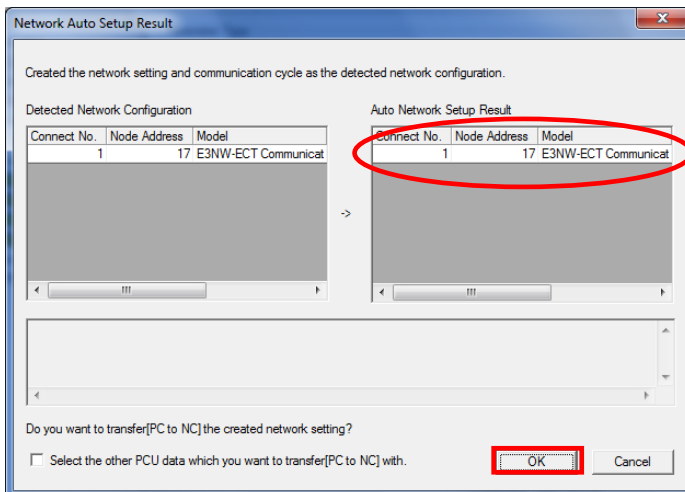

6 The dialog box on the right is displayed. Check the message on the dialog and if there is no problem, click the **OK** Button.

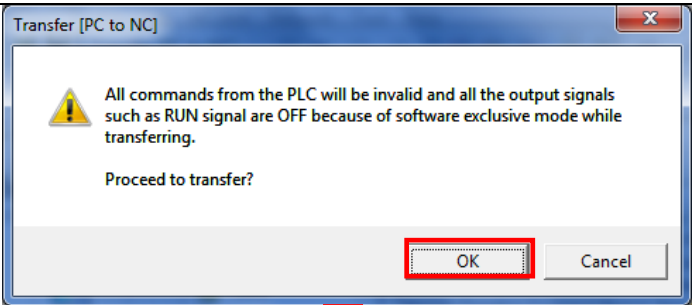

*If a confirmation dialog box is displayed, check the message and if there is no problem, click the **OK** Button.

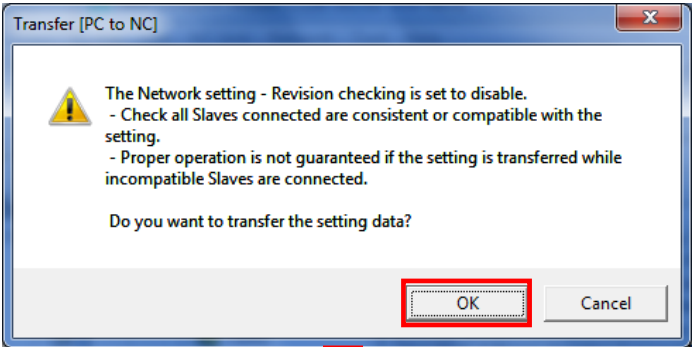

The dialog box on the right is displayed. Check the message on the dialog and if there is no problem, click the **OK** Button.

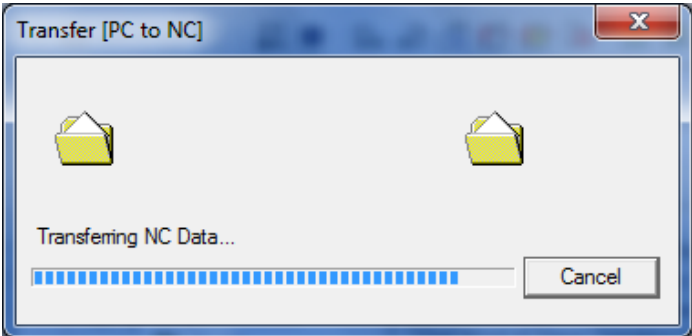

The dialog box on the right is displayed. Check the message on the dialog and if there is no problem, click the **OK** Button.

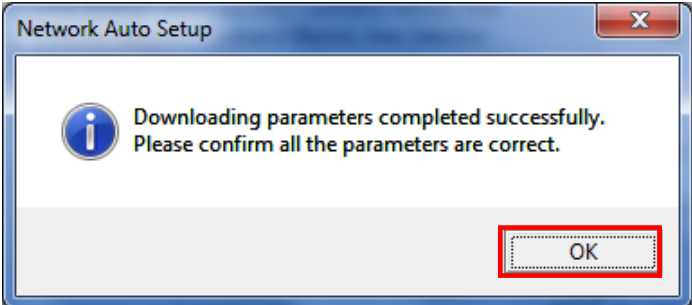
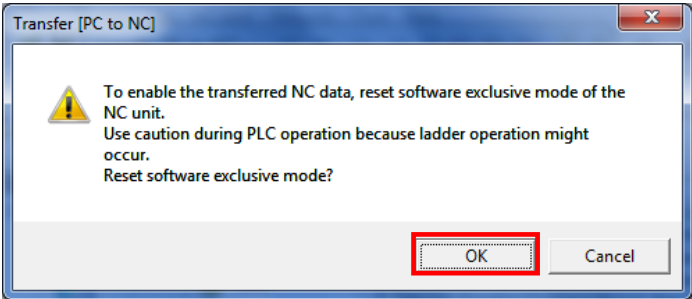

7 The PCU Setting Window is displayed. Select **Network Setting** from the project tree on the left side of the Window. Confirm that *#17_New Slave E3NW-ECT Communication Unit for Digital Type Sensor 60 inputs(V1.0)* was added.

*The model and version may differ depending on the device used.

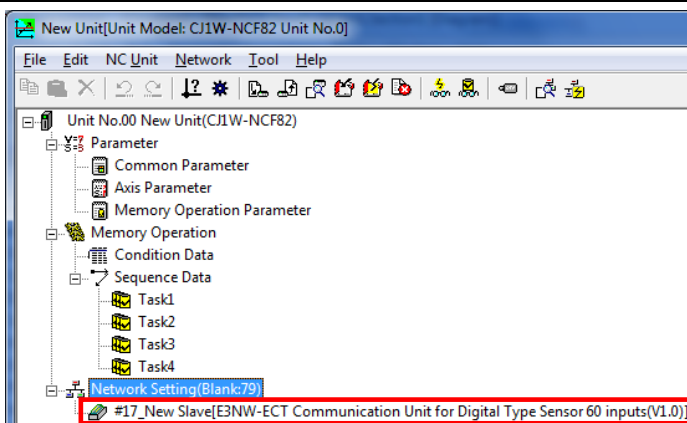

8 Click the Remote I/O Input/Output Memory Area Allocation List Tab that is on the right side on the PCU Parameter Setting Window. Confirm that node address #17 is displayed and the I/O Memory Areas are set as follows:

- Input offset: 0
- Input address: 3900
- Input size: 10 bytes
- Output offset: -
- Output address: -
- Output size: 0 byte

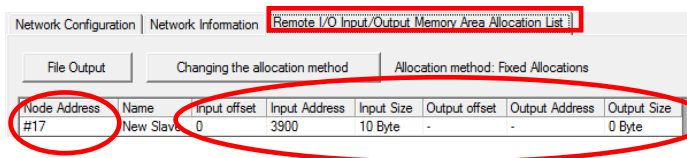

9 Select **Verify Network** from the Network Menu.

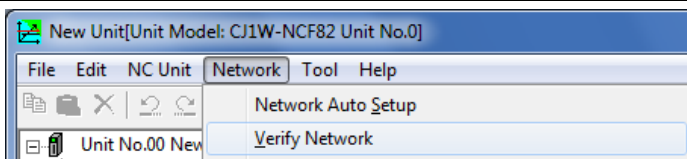

10 Confirm that *Matched* is displayed on the Network Verification Result Dialog Box, and click the **OK** Button.

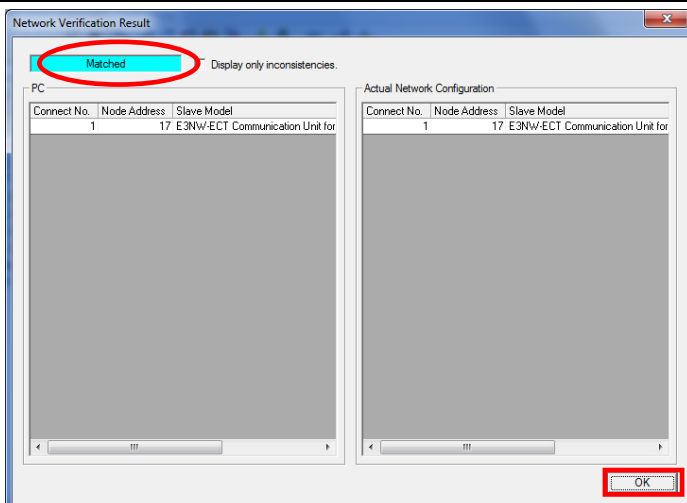

7.4. Checking the EtherCAT Communications

Confirm that the EtherCAT communications are performed normally.

7.4.1. Checking the Connection Status

Check the connection status of the EtherCAT network.

- 1 Check the LED indicators on the Position Control Unit and confirm that the EtherCAT communications are performed normally.

LED indicators in normal status:

- [RUN]: Lit green
- [ERC]: Not lit
- [ERH]: Not lit
- [ECAT RUN]: Lit green
- [ECAT ERR]: Not lit
- [L/A]: Flickering

The 7-segment display shows as follows during normal EtherCAT communications.

The 7-segment display: 00 Lit
(During EtherCAT communications)

The status of each LED indicator is shown on the right.



(Upper side of Position Control Unit)

Indicator	Display color	State	Description
RUN	Green	ON	Normal operation.
		OFF	The power supply is OFF, a hardware error has occurred, or the PLC has detected a PCU error.
ERC	Red	ON	An error has occurred.
		OFF	Other than the above
ERH	Red	ON	There is an error in the PLC.
		OFF	Other than the above

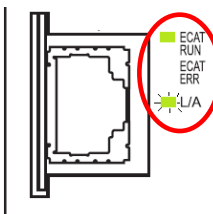

(Lower side of Position Control Unit)

Indicator	Display color	State	Description
ECAT RUN	Green	OFF	Initialized state
		Blinking	Pre-Operational state
		Single flash	Safe-Operational state
		ON	Operational state
ECAT ERR	Red	OFF	No error
		Blinking	Communications setting error
		Single flash	Synchronization error or communications data error
		Double flash	Application WDT timeout
		Flickering	Boot error
L/A	Green	ON	PDI WDT timeout
		OFF	Link not established in physical layer.
		Flickering	Link established in physical layer. In operation after establishing link.

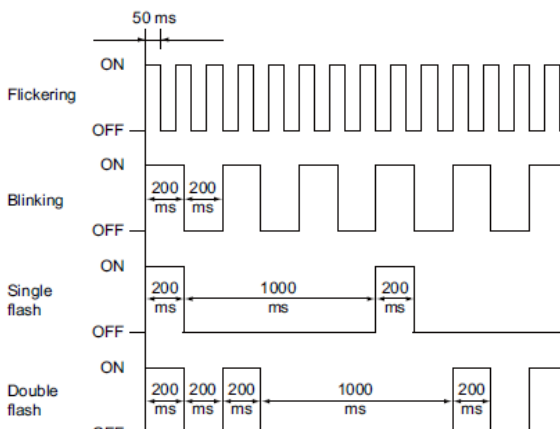

2 Check the LED indicators on the Digital Sensor Communication Unit.

LED indicators in normal status:

- [PWR]: Lit green
- [L/A IN]: Flickering
- [L/A OUT]: Not lit (last slave)
- [RUN]: Lit green
- [ERR]: Not lit
- [SS]: Lit green

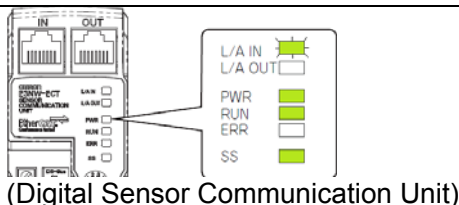

[PWR] indicator

Indicates the unit power supply state.

Color	State	Contents
Green	OFF	Unit power OFF state
	ON	The unit power (24 VDC) is supplied to the Slave Unit.

[L/A IN] indicator

Indicates the communication state (input side).

Color	State	Contents
Green	OFF	Link not established in physical layer
	Flickering	In operation after establishing link
	ON	Link established in physical layer

[L/A OUT] indicator

Indicates the communication state (output side).

Color	State	Contents
Green	OFF	Link not established in physical layer
	Flickering	In operation after establishing link
	ON	Link established in physical layer

[RUN] indicator

It indicates the operation state.

Color	State	Contents
Green	OFF	Init state
	Blinking	Pre-Operational state
	Single flash	Safe-Operational state
	ON	Operational state

[ERR] indicator

It indicates the information of an error.

Color	State	Contents
Red	OFF	No error
	Blinking	Communications setting error
	Single flash	Synchronization error or communications data error
	Flickering	Boot error
	ON	PDI WDT timeout

[SS] indicator

It indicates the information of an Sensor Status.

Color	State	Contents
Green	OFF	Power OFF or Initial status of sensor connection
	ON	Normal
	ON	Sensor Error: Connecting Sensors is different form setting.

The timing of each flashing state of indicator is as follows.

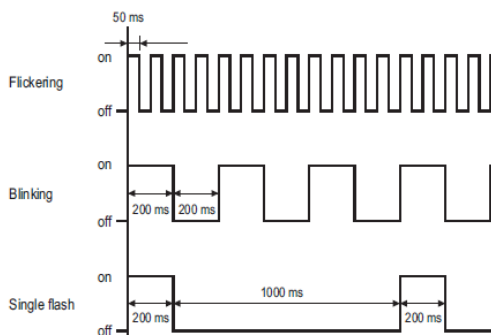

3 Check the LED indicators on the Distributed Sensor Unit.

LED indicators in normal status:

[RUN]: Lit green

[SS]: Lit green

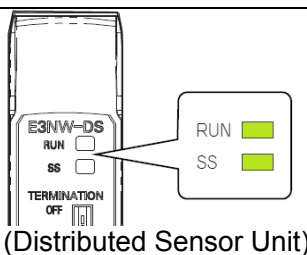

(Distributed Sensor Unit)

● **RUN Indicator**

This indicator gives the operating status.

Color	Status	Meaning
Green	Not lit.	Power OFF, or one of the following errors has occurred: Rotary switch setting error, watchdog timer timeout error, hardware error, RAM check error
	Flashing rapidly	No access for three or more seconds from the Sensor Communication Unit.
	Lit.	Normal status, or Sensor not connected error

● **SS Indicator**

This indicator gives the connection status of the Sensor, or whether there are any other errors.

Color	Status	Meaning
Green	Not lit.	Initial diagnosis in progress, or one of the following errors occurred after the power was cycled: Hardware error or Sensor not connected error
	Lit.	A mismatch error between the number of connected Sensors setting and the number of actually connected Sensors or a RAM check error occurred.
	Lit.	Number of connected Sensors comparison error, too many sensors connected error, RAM check error, or rotary switch setting error



Additional Information

For details on errors in the Position Control Unit, refer to *Section 13 Troubleshooting* of the *CJ-series Position Control Unit Operation Manual* (Cat. No. W487).



Additional Information

For details on errors in the Digital Sensor Communication Unit and the Distributed Sensor Unit, refer to *Chapter 8 Troubleshooting and Maintenance* of the *EtherCAT® Digital Sensor Communication Unit Operation Manual* (Cat. No. E429).

7.4.2. Checking Data that are Sent and Received

Confirm that correct data are sent and received.

Caution

Confirm safety sufficiently before monitoring power flow and present value status in the Ladder Section window or before monitoring present values in the Watch window.

If force-set/reset or set/reset operations are incorrectly performed by pressing short-cut keys, the devices connected to Output Units may malfunction, regardless of the operating mode of the CPU Unit.

- 1 Confirm that the PLC is in PROGRAM mode.

*If the PLC is not in the PROGRAM mode, change to PROGRAM mode by referring to step 1 of 7.3.3. Creating the I/O Table.

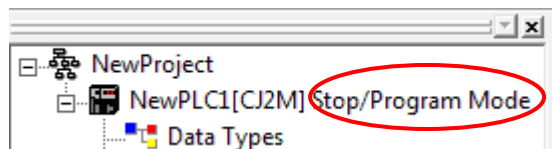

- 2 Select **Edit - Memory** from the PLC Menu.

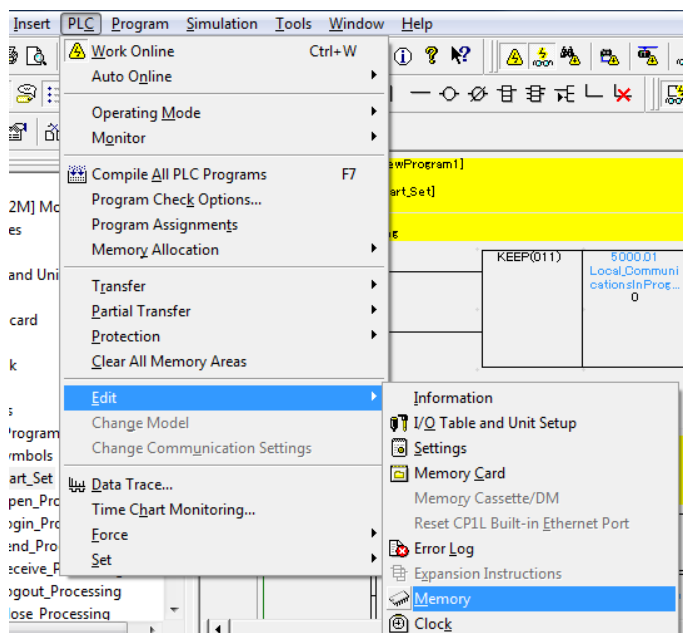

3 Double-click **CIO** from the list in the PLC Memory Window that is displayed.

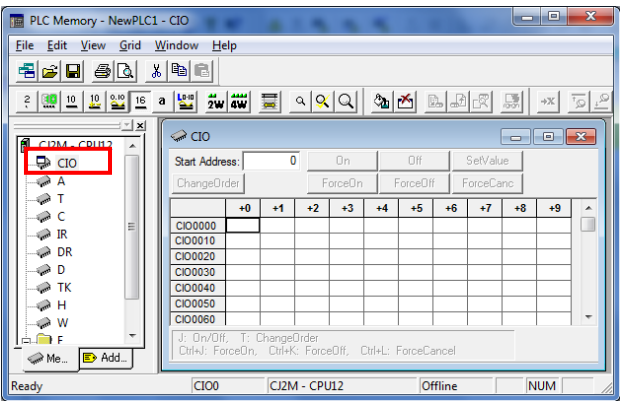

4 Select **Display - Hexadecimal** from the View Menu.

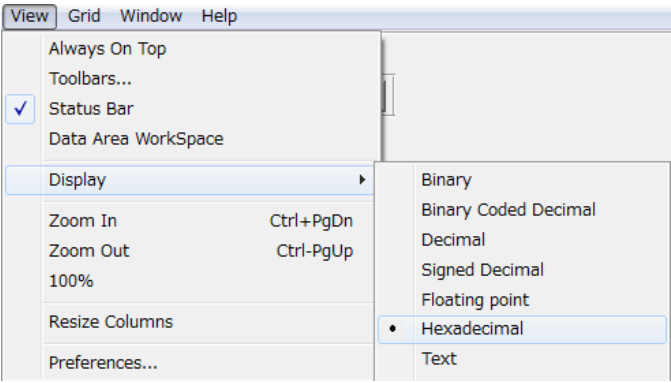

5 Select **Monitor** from the Online Menu.

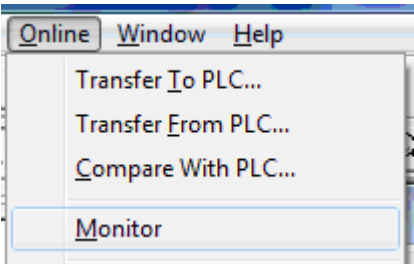

6 The Monitor Memory Areas Dialog Box is displayed. Select the **CIO** Check Box and click the **Monitor** Button.

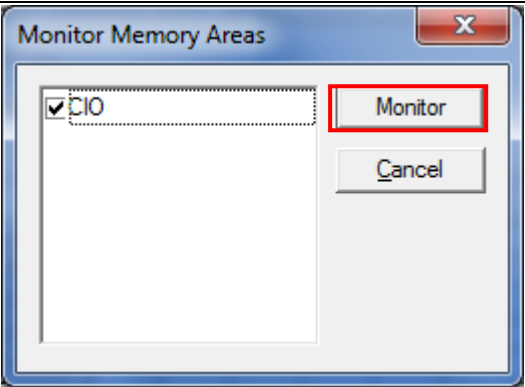

7 Check the display contents of the Fiber Amplifier.

The LED indicators in the figure on the right show as follows:

Outputs of Sensor unit No. 1

IN2[2]: Lit orange (ON)

IN1[1]: Lit orange (ON)

*They are the outputs of the Fiber Amplifier connected to the Digital Sensor Communication Unit.

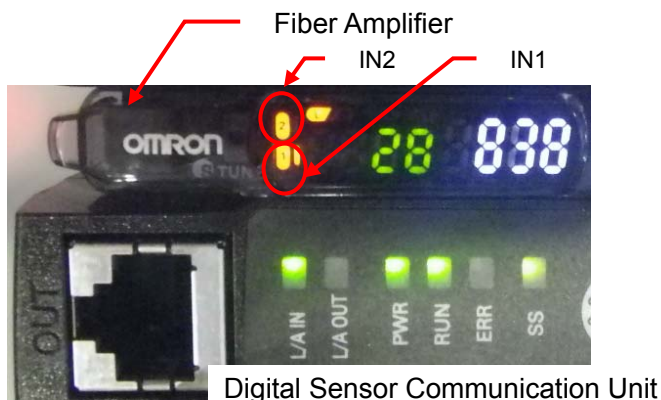

Digital Sensor Communication Unit and Fiber Amplifier (Sensor unit No. 1)

Outputs of Sensor unit No. 2

IN2[2]: Lit orange (ON)

IN1[1]: Lit orange (ON)

*They are the outputs of the Fiber Amplifier connected to the Distributed Sensor Unit.

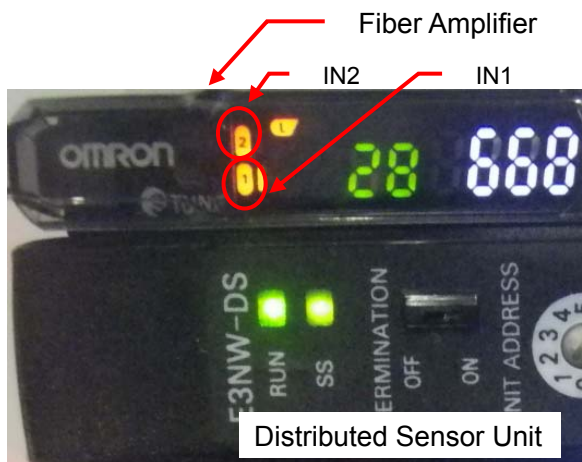

Distributed Sensor Unit and Fiber Amplifier (Sensor unit No. 2)

8 Enter 3900 in the Start Address Field on the CIO Window. Confirm that the start address was changed to 3900.

The right example shows as follows:
CIO 3900: 000F (IN1 and IN2 of Sensor unit No. 1 and 2 are turned ON.)

CIO 3902: 0200 (BUSY: OFF, S_ERR: OFF, Number of Sensors setting: 2)

CIO 3903: 0002 (Number of Sensors: 2)

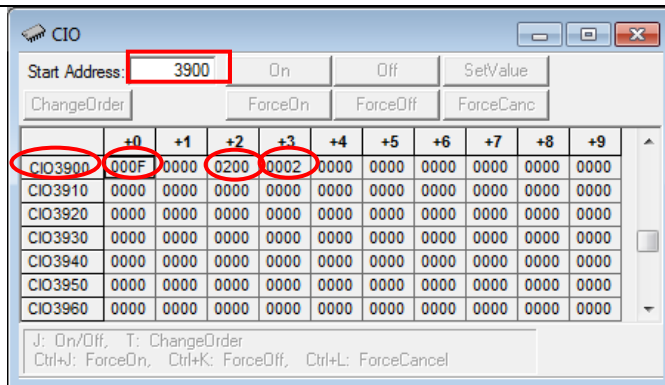

8. Initialization Method

This document explains the setting procedure from the factory default setting. Some settings may not be applicable as described in this document unless you use the devices with the factory default setting.

8.1. Initializing the PLC

To initialize the PLC, it is necessary to initialize the CPU Unit and the Position Control Unit. Change to the PROGRAM Mode before initialization.

8.1.1. Position Control Unit

(1) Select **Edit - I/O Table and Unit Setup** from the PLC Menu of the CX-Programmer. On the PLC IO Table Dialog Box, right-click the Position Control Unit and select **Unit Setup** from the menu.

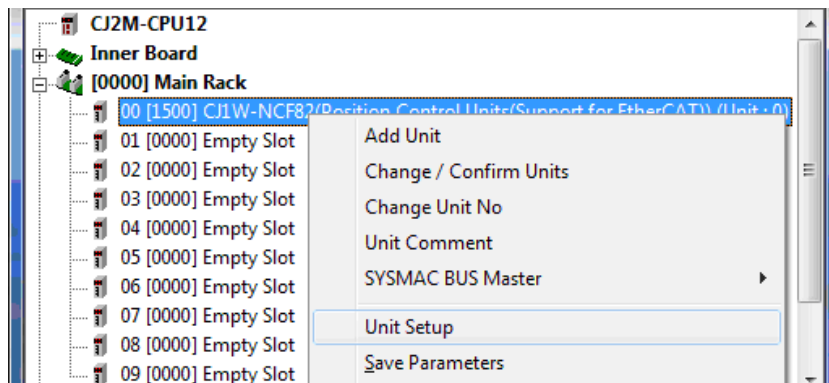

(2) The PCU Parameter Setting Window is displayed. Select **Initialize Memory** from the NC Unit Menu.

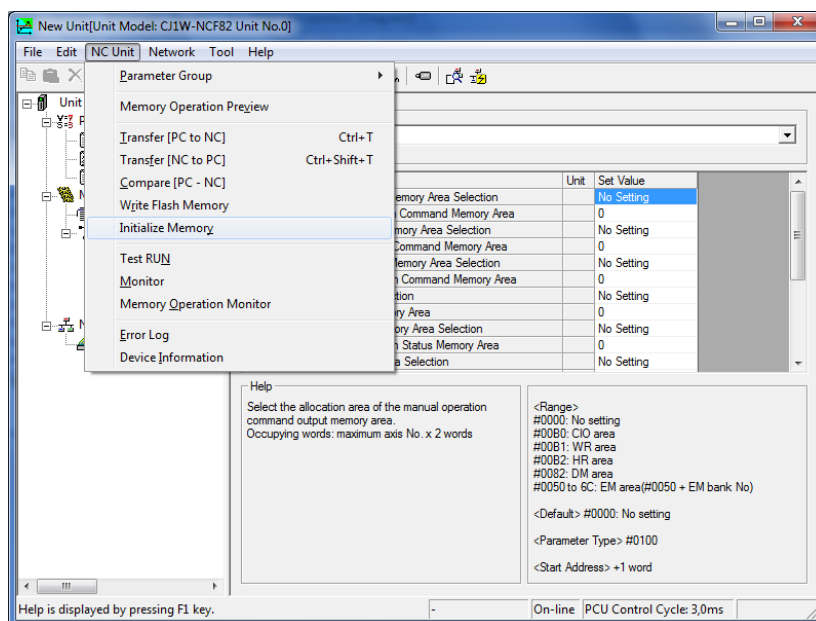

8.1.2. CPU Unit

To initialize the settings of the CPU Unit, select **Clear All Memory Areas** from the PLC Menu of the CX-Programmer. On the Confirm All Memory Area Clear Dialog Box, select the *Initialize* Option and click the **OK** Button.

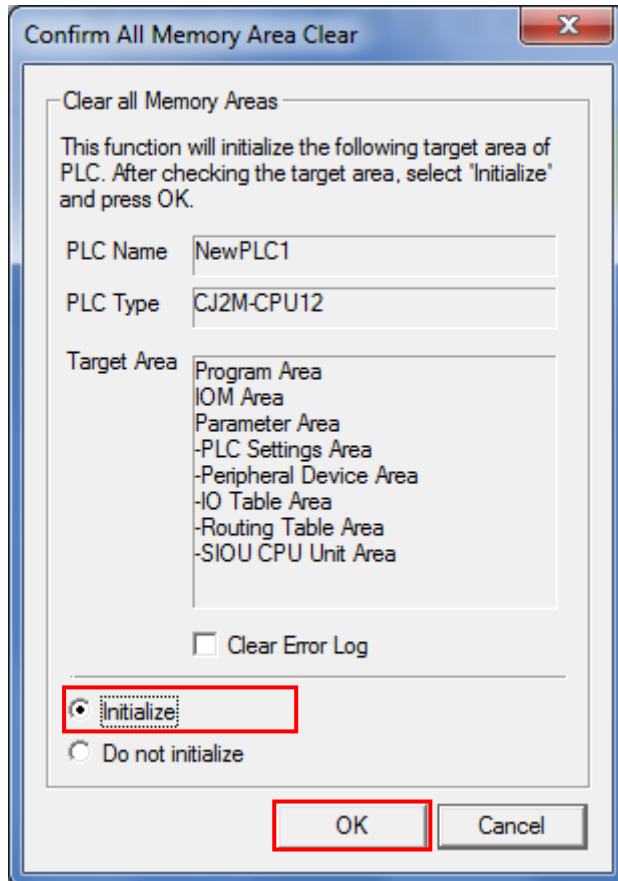

9. Revision History

Revision code	Date of revision	Revision reason and revision page
01	2013/06/07	First edition

OMRON Corporation Industrial Automation Company

Tokyo, JAPAN

Contact: www.ia.omron.com

Regional Headquarters

OMRON EUROPE B.V.

Wegalaan 67-69-2132 JD Hoofddorp
The Netherlands

Tel: (31)2356-81-300/Fax: (31)2356-81-388

OMRON ELECTRONICS LLC

One Commerce Drive Schaumburg,
IL 60173-5302 U.S.A.

Tel: (1) 847-843-7900/Fax: (1) 847-843-7787

OMRON ASIA PACIFIC PTE. LTD.

No. 438A Alexandra Road # 05-05/08 (Lobby 2),
Alexandra Technopark,
Singapore 119967

Tel: (65) 6835-3011/Fax: (65) 6835-2711

OMRON (CHINA) CO., LTD.

Room 2211, Bank of China Tower,
200 Yin Cheng Zhong Road,
PuDong New Area, Shanghai, 200120, China

Tel: (86) 21-5037-2222/Fax: (86) 21-5037-2200

Authorized Distributor:

© OMRON Corporation 2013 All Rights Reserved.
In the interest of product improvement,
specifications are subject to change without notice.

Cat. No. P562-E1-01

0911(-)