

**E5CN-HT**  
**E5AN-HT**  
**E5EN-HT**

## Digital Controllers

# Communications Manual Programmable Type



# Preface

---

The E5CN/AN/EN-HT support serial communications.

This Communications Manual describes the communications functions of the E5CN/AN/EN-HT. Before using your E5CN/AN/EN-HT, thoroughly read and understand this manual in order to ensure correct use. Also, store this manual in a safe place so that it can be retrieved whenever necessary.

For information on the E5CN/AN/EN-H Advanced Type Digital Controllers, refer to the *E5CN-H/E5AN-H/E5EN-H Digital Controllers Advanced Type Communications Manual* (Cat. No. H159).

For information on the E5CN/AN/EN/GN Basic Type Digital Controllers, refer to the *E5CN/E5AN/E5EN/E5GN Digital Controllers Basic Type Communications Manual* (Cat. No. H158).

A PDF version of these manuals can be downloaded from the OMRON website.

<http://www.ia.omron.com>

**© OMRON, 2010-2022**

All rights reserved. No part of this publication may be reproduced, stored in a retrieval system or transmitted, in any form, or by any means, mechanical, electronic, photocopying, recording, or otherwise, without the prior written permission of OMRON.

No patent liability is assumed with respect to the use of the information contained herein. Moreover, because OMRON is constantly striving to improve its high-quality products, the information contained in this manual is subject to change without notice. Every precaution has been taken in the preparation of this manual. Nevertheless, OMRON assumes no responsibility for errors or omissions. Neither is any liability assumed for damages resulting from the use of the information contained in this publication.

## Read and Understand this Manual

Please read and understand this manual before using the products. Please consult your OMRON representative if you have any questions or comments.

## Warranty, Limitations of Liability

### WARRANTY

OMRON's exclusive warranty is that the products are free from defects in materials and workmanship for a period of one year (or other period if specified) from date of sale by OMRON.

OMRON MAKES NO WARRANTY OR REPRESENTATION, EXPRESS OR IMPLIED, REGARDING NON-INFRINGEMENT, MERCHANTABILITY, OR FITNESS FOR PARTICULAR PURPOSE OF THE PRODUCTS. ANY BUYER OR USER ACKNOWLEDGES THAT THE BUYER OR USER ALONE HAS DETERMINED THAT THE PRODUCTS WILL SUITABLY MEET THE REQUIREMENTS OF THEIR INTENDED USE. OMRON DISCLAIMS ALL OTHER WARRANTIES, EXPRESS OR IMPLIED.

### LIMITATIONS OF LIABILITY

OMRON SHALL NOT BE RESPONSIBLE FOR SPECIAL, INDIRECT, OR CONSEQUENTIAL DAMAGES, LOSS OF PROFITS OR COMMERCIAL LOSS IN ANY WAY CONNECTED WITH THE PRODUCTS, WHETHER SUCH CLAIM IS BASED ON CONTRACT, WARRANTY, NEGLIGENCE, OR STRICT LIABILITY.

In no event shall the responsibility of OMRON for any act exceed the individual price of the product on which liability is asserted.

IN NO EVENT SHALL OMRON BE RESPONSIBLE FOR WARRANTY, REPAIR, OR OTHER CLAIMS REGARDING THE PRODUCTS UNLESS OMRON'S ANALYSIS CONFIRMS THAT THE PRODUCTS WERE PROPERLY HANDLED, STORED, INSTALLED, AND MAINTAINED AND NOT SUBJECT TO CONTAMINATION, ABUSE, MISUSE, OR INAPPROPRIATE MODIFICATION OR REPAIR.

## Application Considerations

### SUITABILITY FOR USE

OMRON shall not be responsible for conformity with any standards, codes, or regulations that apply to the combination of the products in the customer's application or use of the products.

At the customer's request, OMRON will provide applicable third party certification documents identifying ratings and limitations of use that apply to the products. This information by itself is not sufficient for a complete determination of the suitability of the products in combination with the end product, machine, system, or other application or use.

The following are some examples of applications for which particular attention must be given. This is not intended to be an exhaustive list of all possible uses of the products, nor is it intended to imply that the uses listed may be suitable for the products:

- Outdoor use, uses involving potential chemical contamination or electrical interference, or conditions or uses not described in this manual.
- Nuclear energy control systems, combustion systems, railroad systems, aviation systems, medical equipment, amusement machines, vehicles, safety equipment, and installations subject to separate industry or government regulations.
- Systems, machines, and equipment that could present a risk to life or property.

Please know and observe all prohibitions of use applicable to the products.

NEVER USE THE PRODUCTS FOR AN APPLICATION INVOLVING SERIOUS RISK TO LIFE OR PROPERTY WITHOUT ENSURING THAT THE SYSTEM AS A WHOLE HAS BEEN DESIGNED TO ADDRESS THE RISKS, AND THAT THE OMRON PRODUCTS ARE PROPERLY RATED AND INSTALLED FOR THE INTENDED USE WITHIN THE OVERALL EQUIPMENT OR SYSTEM.

### PROGRAMMABLE PRODUCTS

OMRON shall not be responsible for the user's programming of a programmable product, or any consequence thereof.

## Disclaimers

### **CHANGE IN SPECIFICATIONS**

Product specifications and accessories may be changed at any time based on improvements and other reasons.

It is our practice to change model numbers when published ratings or features are changed, or when significant construction changes are made. However, some specifications of the products may be changed without any notice. When in doubt, special model numbers may be assigned to fix or establish key specifications for your application on your request. Please consult with your OMRON representative at any time to confirm actual specifications of purchased products.

### **DIMENSIONS AND WEIGHTS**

Dimensions and weights are nominal and are not to be used for manufacturing purposes, even when tolerances are shown.

### **PERFORMANCE DATA**

Performance data given in this manual is provided as a guide for the user in determining suitability and does not constitute a warranty. It may represent the result of OMRON's test conditions, and the users must correlate it to actual application requirements. Actual performance is subject to the OMRON Warranty and Limitations of Liability.

### **ERRORS AND OMISSIONS**

The information in this manual has been carefully checked and is believed to be accurate; however, no responsibility is assumed for clerical, typographical, or proofreading errors, or omissions.

## Safety Precautions

### ■ Definition of Precautionary Information

The following notation is used in this manual to provide precautions required to ensure safe usage of the product.

The safety precautions that are provided are extremely important to safety. Always read and heed the information provided in all safety precautions.

The following notation is used.







**CAUTION**

Indicates a potentially hazardous situation which, if not avoided, is likely to result in minor or moderate injury or in property damage.

### ■ Symbols

Symbol		Meaning
Caution		<b>General Caution</b> Indicates non-specific general cautions, warnings, and dangers.
		<b>Electrical Shock Caution</b> Indicates possibility of electric shock under specific conditions.
Prohibition		<b>General Prohibition</b> Indicates non-specific general prohibitions.
Mandatory Caution		<b>General Caution</b> Indicates non-specific general cautions, warnings, and dangers.

## ■ Safety Precautions

 <b>CAUTION</b>	
Do not touch the terminals while power is being supplied. Doing so may occasionally result in minor injury due to electric shock.	
Do not allow pieces of metal, wire clippings, or fine metallic shavings or filings from installation to enter the product. Doing so may occasionally result in electric shock, fire, or malfunction.	
Do not use the product where subject to flammable or explosive gas. Otherwise, minor injury from explosion may occasionally occur.	
Never disassemble, modify, or repair the product or touch any of the internal parts. Minor electric shock, fire, or malfunction may occasionally occur.	
<p><b>CAUTION - Risk of Fire and Electric Shock</b></p> <p>a) This product is UL listed as Open Type Process Control Equipment. It must be mounted in an enclosure that does not allow fire to escape externally.</p> <p>b) When using more than one shutoff switch, always turn OFF all the shutoff switches to ensure that no power is being supplied before servicing the product.</p> <p>c) Signal inputs are SELV, limited energy. (See note 1.)</p> <p>d) Caution: To reduce the risk of fire or electric shock, do not interconnect the outputs of different Class 2 circuits. (See note 2.)</p>	
If the output relays are used past their life expectancy, contact fusing or burning may occasionally occur. Always consider the application conditions and use the output relays within their rated load and electrical life expectancy. The life expectancy of output relays varies considerably with the output load and switching conditions.	

Note 1: An SELV circuit is one separated from the power supply with double insulation or reinforced insulation, that does not exceed 30 V r.m.s. and 42.4 V peak or 60 VDC.

Note 2: A class 2 power supply is one tested and certified by UL as having the current and voltage of the secondary output restricted to specific levels.

 **CAUTION**

Tighten the terminal screws to between 0.74 and 0.90 N·m. Loose screws may occasionally result in fire.

Set the parameters of the product so that they are suitable for the system being controlled. If they are not suitable, unexpected operation may occasionally result in property damage or accidents.

A malfunction in the Digital Controller may occasionally make control operations impossible or prevent alarm outputs, resulting in property damage. To maintain safety in the event of malfunction of the Digital Controller, take appropriate safety measures, such as installing a monitoring device on a separate line.

When inserting the body of the Digital Controller into the case, confirm that the hooks on the top and bottom are securely engaged with the case. If the body of the Digital Controller is not inserted properly, faulty contact in the terminal section or reduced water resistance may occasionally result in fire or malfunction.

When connecting the Control Output Unit to the socket, press it in until there is no gap between the Control Output Unit and the socket. Otherwise contact faults in the connector pins may occasionally result in fire or malfunction.





Take adequate security measures against DDoS attacks (Distributed Denial of Service attacks), computer viruses and other technologically harmful programs, unauthorized access and other possible attacks before using this product.

## ■ Security Measures

<p><b>Anti-virus protection</b> Install the latest commercial-quality antivirus software on the computer connected to the control/monitor system and maintain to keep the software up-to-date.</p>	
<p><b>Security measures to prevent unauthorized access</b> Take the following measures to prevent unauthorized access to our products.</p> <ul style="list-style-type: none"> <li>• Install physical controls so that only authorized personnel can access control/monitor systems and equipment.</li> <li>• Reduce connections to control/monitor systems and equipment via networks to prevent access from untrusted devices.</li> <li>• Install firewalls to shut down unused communications ports and limit communications hosts and isolate control/monitor systems and equipment from the IT network.</li> <li>• Use a virtual private network (VPN) for remote access to control/monitor systems and equipment.</li> <li>• Scan virus to ensure safety of SD cards or other external storages before connecting them to control/monitor systems and equipment.</li> </ul>	
<p><b>Data input and output protection</b> Validate backups and ranges to cope with unintentional modification of input/output data to control/monitor systems and equipment.</p> <ul style="list-style-type: none"> <li>• Checking the scope of data</li> <li>• Checking validity of backups and preparing data for restore in case of falsification and abnormalities</li> <li>• Safety design, such as emergency shutdown, in case of data tampering and abnormalities</li> </ul>	
<p><b>Data recovery</b> Backup data and keep the data up-to-date periodically to prepare for data loss.</p>	

## Precautions for Safe Use

Be sure to observe the following precautions to prevent operation failure, malfunction, or adverse affects on the performance and functions of the product. Not doing so may occasionally result in unexpected events. Do not handle the Controller in ways that exceed product specifications.

- 1) The product is designed for indoor use only. Do not use the product outdoors or in any of the following locations.
  - Places directly subject to heat radiated from heating equipment.
  - Places subject to splashing liquid or oil atmosphere.
  - Places subject to direct sunlight.
  - Places subject to dust or corrosive gas (in particular, sulfide gas and ammonia gas).
  - Places subject to intense temperature change.
  - Places subject to icing and condensation.
  - Places subject to vibration and large shocks.
- 2) Use and store the Digital Controller within the rated ambient temperature and humidity. Gang-mounting two or more Digital Controllers, or mounting Digital Controllers above each other may cause heat to build up inside the Digital Controllers, which will shorten their service life. In such a case, use forced cooling by fans or other means of air ventilation to cool down the Digital Controllers.
- 3) To allow heat to escape, do not block the area around the product. Do not block the ventilation holes on the product.
- 4) Be sure to wire properly with correct polarity of terminals.
- 5) Use specified size (M3.5, width 7.2 mm or less) crimped terminals for wiring. To connect bare wires, use stranded or solid copper wires with a gage of AWG24 to AWG14 (equal to cross-sectional areas of 0.205 to 2.081 mm<sup>2</sup>). (The stripping length is 5 to 6 mm.) Up to two wires of same size and type, or two crimp terminals can be inserted into a single terminal.
- 6) Do not wire the terminals which are not used.
- 7) To avoid inductive noise, keep the wiring for the Digital Controller's terminal block away from power cables carry high voltages or large currents. Also, do not wire power lines together with or parallel to Digital Controller wiring. Using shielded cables and using separate conduits or ducts is recommended.

Attach a surge suppressor or noise filter to peripheral devices that generate noise (in particular, motors, transformers, solenoids, magnetic coils or other equipment that have an inductance component).

When a noise filter is used at the power supply, first check the voltage or current, and attach the noise filter as close as possible to the Digital controller.

Allow as much space as possible between the Digital Controller and devices that generate powerful high frequencies (high-frequency welders, high-frequency sewing machines, etc.) or surge.
- 8) Use this product within the rated load and power supply.
- 9) Make sure that the rated voltage is attained within two seconds of turning ON the power using a switch or relay contact. If the voltage is applied gradually, the power may not be reset or output malfunctions may occur.
- 10) Make sure that the Digital Controller has 30 minutes or more to warm up after turning ON the power before starting actual control operations to ensure the correct temperature display.
- 11) A switch or circuit breaker should be provided close to this unit. The switch or circuit breaker should be within easy reach of the operator, and must be marked as a disconnecting means for this unit.
- 12) Always turn OFF the power supply before pulling out the interior of the product, and never touch nor apply shock to the terminals or electronic components. When inserting the interior of the product, do not allow the electronic components to touch the case.

- 13) Do not use paint thinner or similar chemical to clean with. Use standard grade alcohol.
- 14) Design system (control panel, etc) considering the 2 second of delay that the controller's output to be set after power ON.
- 15) The output may turn OFF when shifting to certain levels. Take this into consideration when performing control.
- 16) The number of nonvolatile memory write operations is limited. Therefore, use RAM write mode when frequently overwriting data during communications or other operations.
- 17) Always touch a grounded piece of metal before touching the Digital Controller to discharge static electricity from your body.
- 18) Do not remove the terminal block. Doing so may result in failure or malfunction.
- 19) Control outputs that are voltage outputs are not isolated from the internal circuits. When using a grounded thermocouple, do not connect any of the control output terminals to ground. (Doing so may result in an unwanted circuit path, causing error in the measured temperature.)
- 20) When replacing the body of the Digital Controller, check the condition of the terminals. If corroded terminals are used, contact failure in the terminals may cause the temperature inside the Digital Controller to increase, possibly resulting in fire. If the terminals are corroded, replace the case as well.
- 21) Use suitable tools when taking the Digital Controller apart for disposal. Sharp parts inside the Digital Controller may cause injury.
- 22) Check the specifications of the Control Output Unit and assemble it correctly.
- 23) When mounting the Control Output Unit, read and follow all relevant information in the product catalogs and manuals.
- 24) Do not continue to use the product if the front surface peels or becomes cracked.



# Conventions Used in This Manual

## ■ How This Manual is Organized

Descriptions in this manual are separated by the communications method.

Read the sections that are application to the system being used.

Overview

CompoWay/F

Communications Data  
for CompoWay

Modbus

Communications Data  
for Modbus

Appendix

Overview

CompoWay/F

Com Data for  
CompoWay/F

Modbus

Com Data  
for Modbus

Appendix

## ■ Related Manuals

This manual describes the communications functions of the E5CN/AN/EN-HT.

For details on the functions of the E5CN/AN/EN-HT, refer to *E5CN/AN/EN-HT Digital Controllers Program Type User's Manual* (Cat. No. H169)



# Table of Contents

---

Preface	I
Read and Understand this Manual	II
Warranty, Limitations of Liability	II
Application Considerations	II
Disclaimers	III
Safety Precautions	IV
Precautions for Safe Use	VIII
Conventions Used in This Manual	XI

## SECTION 1

### Communications Methods

1.1 Overview of Communications Methods	1-2
Introduction	1-2
Communications Specifications	1-3
Transmission Procedure	1-3
Interface	1-4
Wiring	1-4
Communications Parameters	1-8

## SECTION 2

### CompoWay/F Communications Procedures

2.1 Data Format	2-2
Command Frame	2-2
Response Frame	2-3
Communications Data	2-4
End Code Example	2-4
2.2 Structure of Command Text	2-6
PDU Structure	2-6
Area Definitions	2-6
Type Code (Variable Type)	2-6
Addresses	2-7
Number of Elements	2-7
List of Services	2-7
2.3 Detailed Description of the Services	2-9
Read Variable Area	2-9
Write Variable Area	2-10
Composite Read from Variable Area	2-12
Composite Write to Variable Area	2-13
Read Controller Attributes	2-16
Read Controller Status	2-17
Echoback Test	2-18
Operation Command	2-19
2.4 Response Code List	2-26

## SECTION 3

### Communications Data for CompoWay/F

3.1	Variable Area (Setting Range) List .....	3-2
3.2	Status and Status 2 .....	3-20
	Status Structure .....	3-20
	Status 2 Structure .....	3-22
	Status Details .....	3-23
	Status 2 Details .....	3-24

## SECTION 4

### Modbus Communications Procedure

4.1	Data Format .....	4-2
	Command Frame .....	4-2
	Response Frame .....	4-4
	Error Codes .....	4-5
4.2	Function List .....	4-6
4.3	Variable Area .....	4-7
4.4	Detailed Description of the Services .....	4-9
	Variable Read, Multiple .....	4-9
	Variable Write, Multiple .....	4-11
	Variable Write, Single/Operation Command .....	4-14
	Echoback Test .....	4-21

## SECTION 5

### Communications Data for Modbus

5.1	Variable Area (Setting Range) List .....	5-2
5.2	Status and Status 2 .....	5-16
	Status Structure .....	5-16
	Status 2 Structure .....	5-18
	Status Details .....	5-19
	Status 2 Details .....	5-20

## Appendix 1

ASCII List .....	A-2
Troubleshooting .....	A-3

Index .....	I-1
-------------	-----

Revision History .....	R-1
------------------------	-----



# SECTION 1

## Communications Methods

This section briefly describes the supported communications methods and how to wire equipment. Refer to this section when setting up equipment.

1.1	Overview of Communications Methods .....	1-2
	Introduction.....	1-2
	Communications Specifications.....	1-3
	Transmission Procedure.....	1-3
	Interface.....	1-4
	Wiring .....	1-4
	Communications Parameters .....	1-8
	Communications Parameter Setup .....	1-8
	Communications Parameters.....	1-9
	Setting Communications Writing .....	1-10

# 1.1 Overview of Communications Methods

## ■ Introduction

The program for the communications functions are created on the host (personal computer, PLC, or other type of communications master), and the E5CN/AN/EN-HT's parameters are monitored or set from the host. Therefore, the description provided here is from the viewpoint of the host.

CompoWay/F is OMRON's standard communications format for general serial communications. This format uses a standard frame format as well as the well-established FINS\* commands used for OMRON's PLCs. Therefore, it can simplify communications between components and the host.

\*FINS (Factory Interface Network service)

The FINS protocol provides message communications between controllers in OMRON FA networks.

Modbus is a standard communications control method that conforms to the Modicon Company's RTU-mode Modbus Protocol (PI-MBUS-300 Revision J). Modbus is a registered trademark of Schneider Electric.

It supports functions equivalent to the CompoWay/F Read Variable Area, Write Variable Area, Operation Command, and Echoback Test functions.

The E5CN/AN/EN-HT supports the following communications functions.

- Reading/writing of parameters
- Operation instructions
- Selection of setup levels

Communications are subject to the following condition:

- Parameters can be written only when the Communications Writing parameter is set to ON (enabled).

## ■ Communications Specifications

Transmission line connection	RS-485: Multidrop RS-232C: Point-to-point RS-422: Multidrop
Communications method (See note 1.)	RS-485 (2-wire, half-duplex)/RS-232C/ RS-422 (4-wire, half-duplex)
Synchronization method	Start-stop synchronization
Communications baud rate (See note 2.)	1,200, 2,400, 4,800, <b>9,600</b> , 19,200, 38,400 or 57,600 bps
Communications code	ASCII (CompoWay/F) Binary (Modbus)
Communications data length (See notes 2 and 3.)	<b>7</b> or 8 bits
Communications stop bits (See note 2.)	1 or <b>2</b> bits
Error detection	Vertical parity (none, <b>even</b> , or odd) (See note 2.) BCC (Block Check Character) with CompoWay/F communications CRC-16 (Cyclic Redundancy Check 16) with Modbus communications
Flow control	None
Interface	RS-485/RS-232C/RS-422
Retry function	None
Communications buffer	217 bytes
Send data wait time	0 to 99 ms, default time: 20 ms

Note 1: RS-422 is supported by E5AN-HT and E5EN-HT only.

Note 2: Communications speed, data bits, stop bits and vertical parity can each be set independently in the communications setting level. Highlighted values indicate default settings.

Note 3: The communications data length for Modbus must be 8 bits.

## ■ Transmission Procedure

When the host transmits a command frame, the E5CN/AN/EN-HT transmits a response frame that corresponds to the command frame. A single response frame is returned for each command frame. The following diagram shows the operation of the command and response frames.

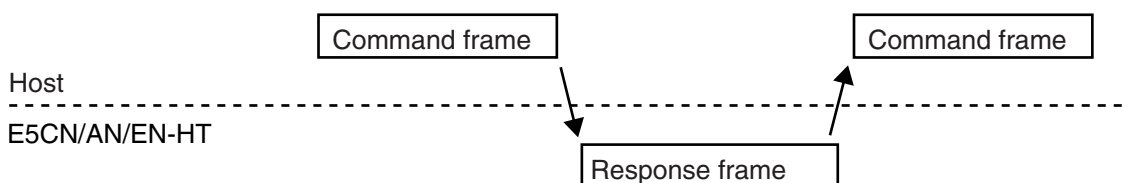

Allow a wait time of at least 2 ms before the next command is sent after the host receives a response from the E5CN/AN/EN-HT.

## ■ Interface

Communications with the host are carried out through a standard RS-485 interface, RS-232C interface, or RS-422 interface (E5AN/E5EN-HT). Use a K3SC Interface Converter for RS-485, RS-232C, and RS-422 interface conversion.

## ■ Wiring

### RS-485

- The RS-485 connection can be either one-to-one or one-to-N. Up to 32 units including the host can be connected in a one-to-N system.
- The total cable length is 500 m max.
- Use a shielded twisted-pair cable with wires of a thickness of AWG24 (0.205 mm<sup>2</sup>) to AWG14 (2.081 mm<sup>2</sup>).

● E5CN-HT

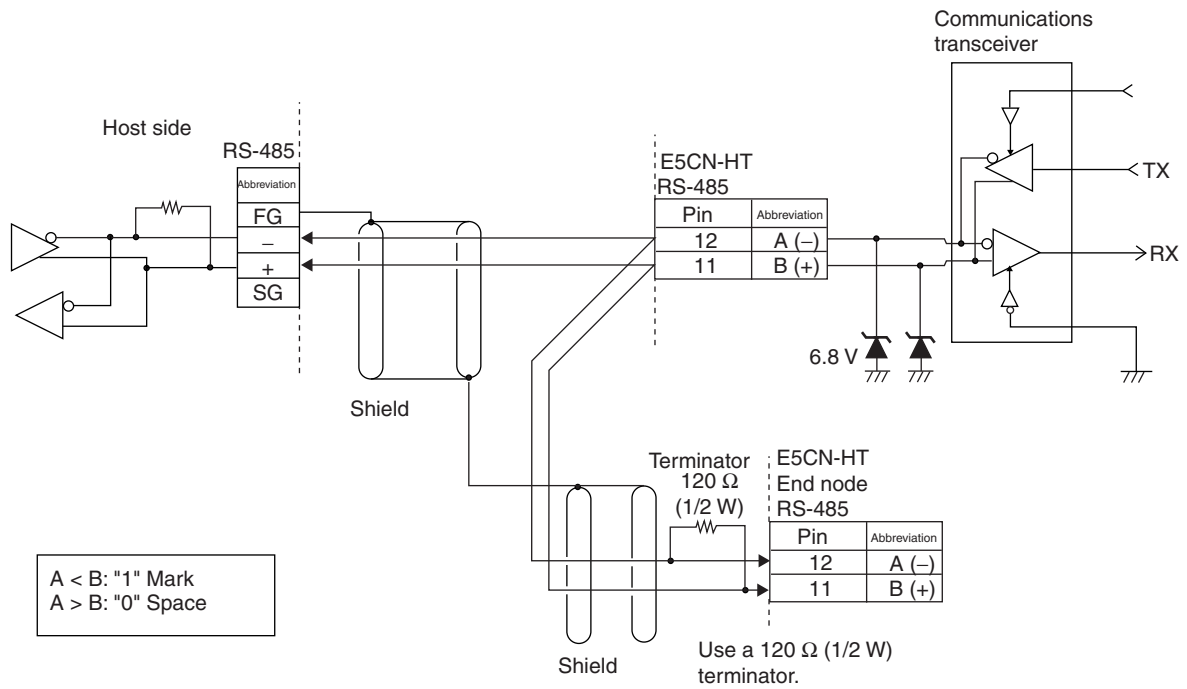

Specify both ends of the transmission path including the host as the end node (that is, connect terminators to both ends).  
Use a terminating resistance of at least 54 Ω.

● E5AN/EN-HT

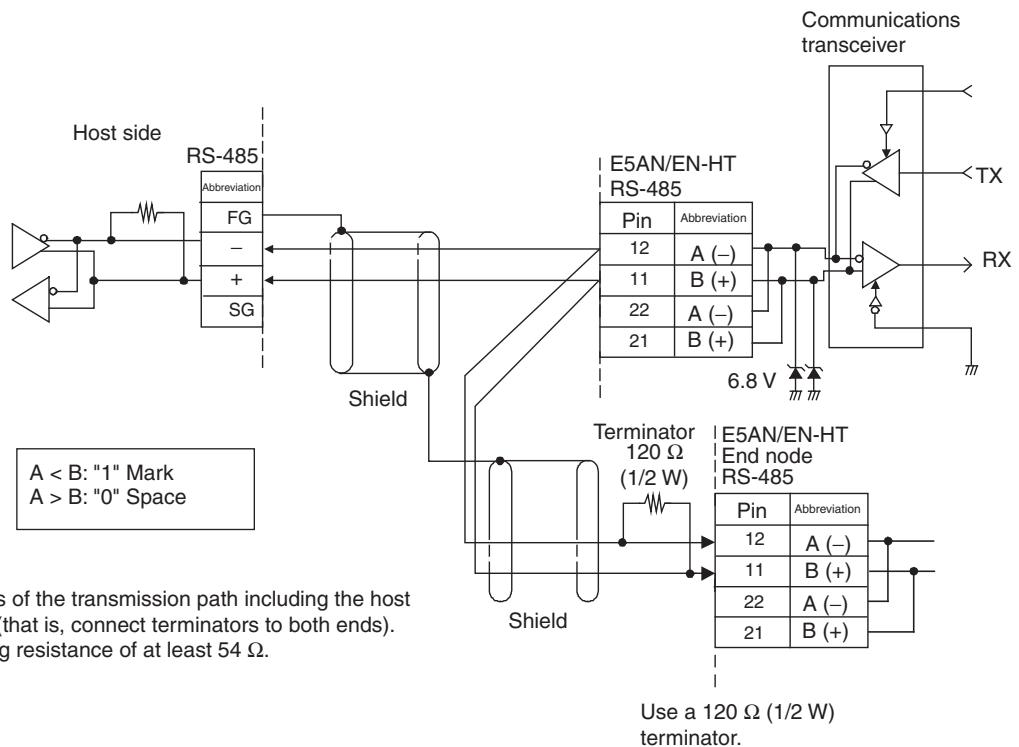

Specify both ends of the transmission path including the host as the end node (that is, connect terminators to both ends).  
Use a terminating resistance of at least 54 Ω.

Match the communications specifications of the E5CN/AN/EN-HT and the host. When using a 1: N connection, set the same communications specifications in all of the Units. (Of course, each Unit must have a unique unit number.)

This section explains how to set the E5CN/AN/EN-HT's communications specifications. For details on the host, refer to the User's Manual provided with the host.

## RS-232C

A 1:1 connection is used. The maximum cable length is 15 m.

Use AWG24 (cross-sectional area: 0.205 mm<sup>2</sup>) to AWG14 (cross-sectional area: 2.081 mm<sup>2</sup>) shielded twisted-pair cable.

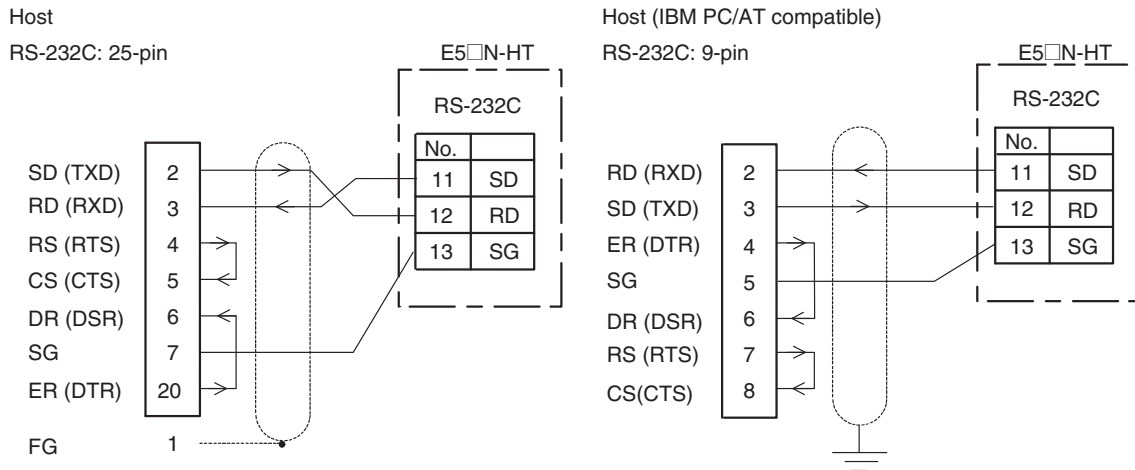

Cable Diagram

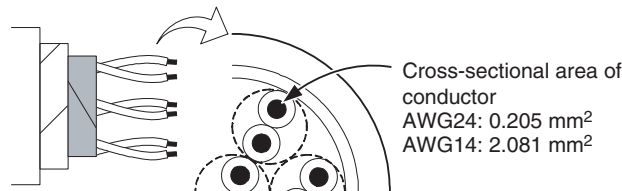

## RS-422 (E5AN/EN-HT Only)

- Connections are 1:1 or 1:N. With 1:N, a maximum of 32 nodes including the host can be connected.
- The maximum total cable length is 500 m.
- Use shielded twisted-pair cable (AWG28 min.).
- Connect a terminator at each end of the transmission path. In the following example, connect a terminator to the host and to Unit #30 and not to any of the other Units (#0 to #29).
- Use terminators with a resistance of 240 Ω (1/2 W). (The combined resistance at both ends must be 100 Ω min.)

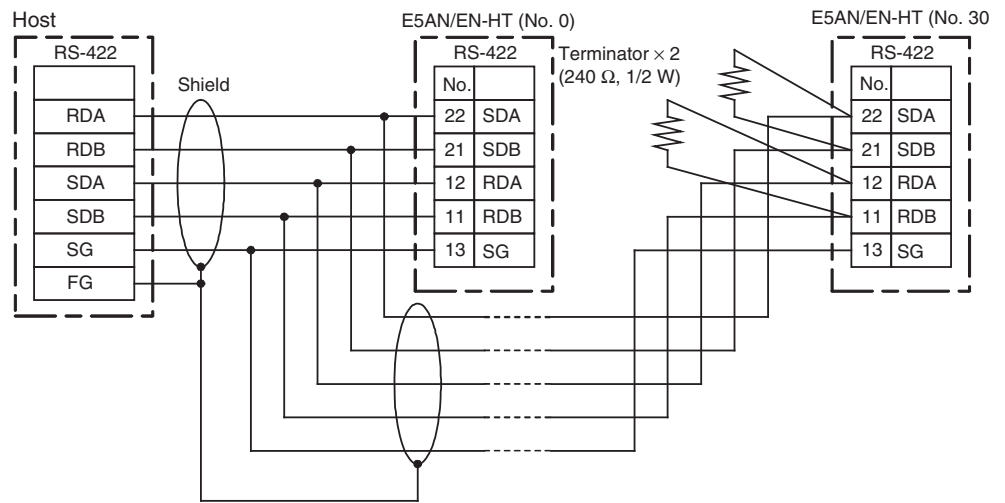

## ■ Communications Parameters

The E5CN/AN/EN-HT's communications specifications are set in the communications setting level. These parameters are set on the E5CN/AN/EN-HT's front panel. The following table shows the communications parameters and their setting ranges.



Item	Code	Settings	Set Values
Communications protocol	<i>PSEL</i>	CompoWay/F or Modbus	<b>LWF</b> /Mod
Communications unit number	<i>U-Nd</i>	0 to 99	0, <b>1</b> to 99
Communications baud rate	<i>bPS</i>	1.2/2.4/4.8/9.6/19.2/38.4/57.6 (kbit/s)	1.2/2.4/4.8/ <b>9.6</b> /19.2/38.4/57.6 (kbit/s)
Communications data length (See note.)	<i>LEN</i>	7/8 (bit)	<b>7</b> /8 (bit)
Communications stop bits	<i>StLt</i>	1/2	1/ <b>2</b>
Communications parity	<i>PRLY</i>	None, Even, Odd	NONE/ <b>EVEN</b> /odd
Send data wait time	<i>SDWT</i>	0 to 99	0 to 99 ms, default time: <b>20</b> ms

Highlighted values indicate default settings.



Note: The communications data length for Modbus must be 8 bits.

## ● Communications Parameter Setup

Before you carry out communications with the E5CN/AN/EN-HT, set up the communications unit number, baud rate, and other parameters by carrying out the following procedure. For details on operations other than communications parameter setup, refer to *E5CN/AN/EN-HT Digital Controllers Program Type User's Manual* (Cat. No. H169) for the devices being used.

1. Press the  Key for at least three seconds to move from the "operation level" to the "initial setting level."
2. Press the  Key for less than one second to move from the "initial setting level" to the "communications setting level."
3. Select the parameters as shown below by pressing the  Key.



4. Use the  or  Keys to change the parameter set values.

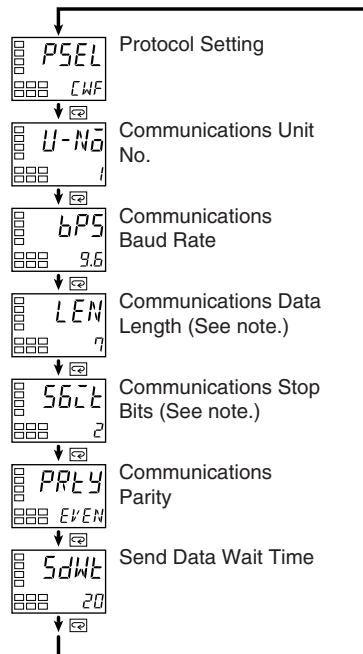

Note: Displayed only when the Protocol Setting parameter is set to CompoWay/F.

### ● Communications Parameters

When communications parameter settings have been changed, the new settings must be enabled by resetting the Controller.





- Protocol Setting (*PSEL*)  
The communications protocol can be selected. Set CompoWay/F or Modbus.
- Communications Unit No. (*U-Nb*)  
This parameter is for setting a unique unit number for each of the Digital Controllers. This unit number is set so that the host can identify the Digital Controller when communications are carried out with the host. The unit number can be set to an integer value between 0 and 99. The default is “1.” When two or more Digital Controllers are used, do not set the same unit number. Doing so will prevent normal operation.
- Communications Baud Rate (*bPS*)  
This parameter is for setting the baud rate for communications with the host. The communications baud rate settings are as follows: 1.2 (1200 bps), 2.4 (2400 bps), 4.8 (4800 bps), 9.6 (9600 bps), 19.2 (19200 bps), 38.4 (38400 bps) or 57.6 (57600 bps)
- Communications Data Length (*LEN*)  
This parameter is for setting the number of communications data bits. Set either “7 bits” or “8 bits.”

- **Communications Stop Bits (*Sb̄lt*)**  
This parameter is for setting the number of communications stop bits. Set either “1” or “2.”
- **Communications Parity (*PR̄LY*)**  
The communications parity can be set. Set the parity to “none,” “even,” or “odd.”
- **Send Data Wait Time (*Sd̄wt*)**  
The send data wait time is the time that the Controller waits from when it receives a command from the host computer until it returns a response. The wait time can be made longer if the response is returned too quickly for the host computer to receive it. The wait time can also be made shorter to make the communications response time faster.  
The send data wait time can be set in 1-ms increments between 0 and 99 ms. The default is 20 ms.

### ● Setting Communications Writing

Set the communications writing parameter to ON to allow the host to write to the E5CN/AN/EN-HT via communications.

#### Parameter Setting

1. Press the  Key for less than one second to move from the operation level to the adjustment level.
2. Select the parameter as shown below by pressing the  Key.
3. Press the  or  Key to set the communications writing parameter to ON.

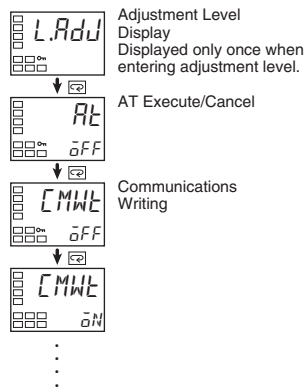

# SECTION 2

## CompoWay/F Communications Procedures

Read this section if you are to communicate using the CompoWay/F format.

2.1	Data Format.....	2-2
	Command Frame.....	2-2
	BCC Calculation Example .....	2-3
	Response Frame .....	2-3
	Communications Data .....	2-4
	End Code Example.....	2-4
2.2	Structure of Command Text.....	2-6
	PDU Structure .....	2-6
	Area Definitions .....	2-6
	Type Code (Variable Type) .....	2-6
	Addresses.....	2-7
	Number of Elements.....	2-7
	List of Services .....	2-7
2.3	Detailed Description of the Services.....	2-9
	Read Variable Area .....	2-9
	Write Variable Area .....	2-10
	Composite Read from Variable Area.....	2-12
	Composite Write to Variable Area .....	2-13
	Read Controller Attributes .....	2-16
	Read Controller Status .....	2-17
	Echoback Test.....	2-18
	Operation Command .....	2-19
2.4	Response Code List .....	2-26

## 2.1 Data Format

Hexadecimal values are expressed by adding the prefix H' before the number, e.g., H'02. Numbers shown without the H' prefix are ASCII characters.

The number underneath each item in a frame indicates the number of bytes.

### ■ Command Frame

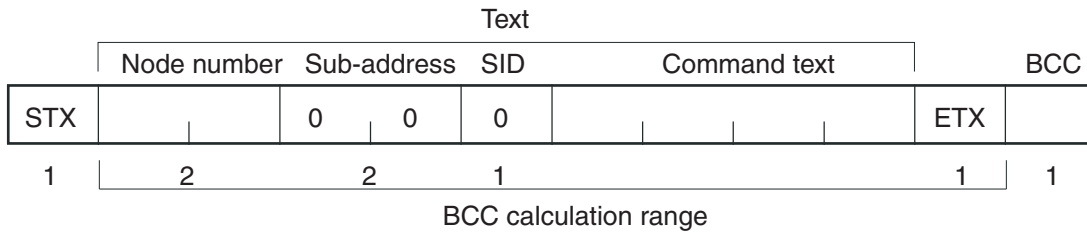

STX	This code (H'02) indicates the beginning of the communications frame (text). Always set this character in the first byte. When STX is received again during reception, reception is carried out again from the point where STX was received.
Node number	<ul style="list-style-type: none"> <li>• This number specifies the transmission's destination.</li> <li>• Specify the E5CN/AN/EN-HT's communications unit number.</li> <li>• A BCD value between 00 and 99 or an ASCII value of XX can be set.</li> <li>• Specify "XX" for a broadcast transmission. No responses will be returned for broadcast transmissions.</li> <li>• No responses will be returned from node numbers other than the ones in the above range.</li> </ul>
Sub-address	The sub-address is not used in the E5CN/AN/EN-HT. Be sure to set the sub-address to "00."
SID (Service ID)	The service ID is not used in the E5CN/AN/EN-HT. Be sure to set the service ID to "00."
Command text	This is the command text area. For details, see <i>2.2 Structure of Command Text</i> .
ETX	This code (H'03) indicates the end of the text.
BCC	This is the Block Check Character. The BCC result is found by calculating the exclusive OR of the bytes from the node number up to ETX.

## ● BCC Calculation Example

The BCC (Block Check Character) is determined by calculating the exclusive OR of the bytes from the node number up to ETX. The 8-bit result is written to the BCC byte at the end of the frame.

STX	Node number	Sub-address	SID	Command text	ETX	BCC
02H	0 (30H)0 (30H)0 (30H)0 (30H)0 (30H)0 (30H)	5 (35H)	0 (30H)	3 (33H)	03H	35H

$BCC = 30H \oplus 30H \oplus 30H \oplus 30H \oplus 30H \oplus 30H \oplus 30H \oplus 30H \oplus 35H \oplus 30H \oplus 33H \oplus 03H = 35H$   
 The result of the calculation (35 hex) is written to the BCC byte.

The ⊕ symbols indicate XOR (exclusive OR) operations.

## ■ Response Frame

STX	Node number	Sub-address	End code	Command text	ETX	BCC
1	2	2	2		1	1

End code	Name	Description	Error detection priority
00	Normal completion	The command ended normally without error.	None
0F	FINS command error	The specified FINS command could not be executed. The FINS response code should indicate why the command could not be executed.	8
10	Parity error	The sum total of bits whose received data is "1" does not match the set value of the "communications parity" bit.	2
11	Framing error	Stop bit is "0."	1
12	Overrun error	An attempt was made to transfer new data when the reception data buffer was already full.	3
13	BCC error	The calculated BCC value is different from the received BCC value.	5
14	Format error	<ul style="list-style-type: none"> <li>The command text contains characters other than 0 to 9, and A to F. This error does not apply to Echoback Tests. (Refer to the Echoback Test for details.)</li> <li>There was no SID and command text. There was no command text.</li> <li>"MRC/SRC" not included in command text.</li> </ul>	7
16	Sub-address error	<ul style="list-style-type: none"> <li>Illegal (unsupported) sub-address</li> <li>There was no sub-address, SID, and command text.</li> <li>Sub-address was less than two characters, and there was no SID and command text</li> </ul>	6
18	Frame length error	The received frame exceeds the specified (supported) number of bytes.	4

- An end code is returned for each command frame received that was addressed to the local node.
- No response will be returned unless the frame contained all elements up to the ETX and BCC.
- "Error Detection Priority" indicates the priority when two or more errors occur simultaneously.

## ■ Communications Data

Communications format	Set (monitor) values	Negative values	Decimal point
CompoWay/F	8-digit hexadecimal	2's complement	Decimal point is removed and the result is converted to hexadecimal. Example conversion: 105.0 → 1050 → H'0000041A However, when reading or writing time data in hh.mm, mm.ss, or dd.hh, BCD data is used (the same format as the display). Example: The data is H'00009959 for a display of 99.59.

## ■ End Code Example

The following examples show the end code when a command did not end normally.

Example 1) Illegal Sub-address, No SID, and No Command Text  
Command

	Node number	Sub-address	BCC
STX		0 A	EXT

Response

	Node number	Sub-address	End code	BCC
STX		0 A	1 6	EXT

End code is "16" (sub-address error).

The sub-address error code is used because the sub-address error has a higher error detection priority than the format error.

Example 2) No Command Text

Command

	Node number	Sub-address	SID	BCC
STX		0 0	0	EXT

Response

	Node number	Sub-address	End code	BCC
STX		0 0	1 4	EXT

The end code is "14" (format error).

Example 3) No Node Number Provided

Command

	BCC
STX	EXT

The node number is lacking one character.

Response

There is no response.

Example 4) No Sub-address and Illegal BCC

Command

Node number		BCC	
STX		EXT	Err

Response

Node number		Sub-address		End code		BCC	
STX		0	0	1	3	EXT	

The sub-address is "00" and the end code is "13" (BCC error).

## 2.2 Structure of Command Text

### ■ PDU Structure

An MRC (Main Request Code) and SRC (Sub-Request Code) followed by the various required data is transferred to the command text.

Service Request PDU



The MRES (Main Response Code) and SRES (Sub-Response Code) are transferred to the response frame following the above MRC/SRC. Data is then transferred following the MRES and SRES.

Service Response PDU (Normal Response)



If the specified command text could not be executed, the service response PDU will contain only the MRC/SRC and MRES/SRES.

Service Response PDU (Command Text Not Executed)



MRES/SRES provides the response code. MRES/SRES are not output when processing ends in a normal completion.

### ■ Area Definitions

Areas comprise only the variable area.

### ■ Type Code (Variable Type)

The following tables show the variable area type codes.

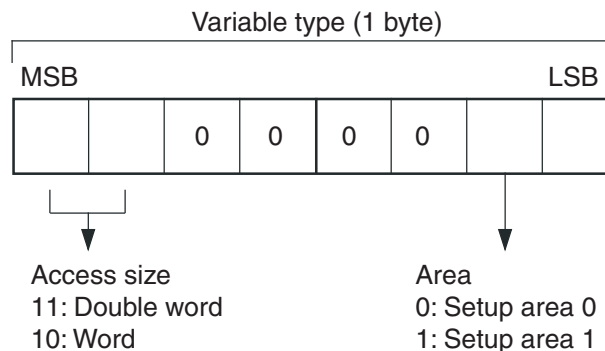



The following table summarizes setup areas 0 and 1.

Area	Description
Setup area 0	This area groups together the protect, manual control, operation, adjustment, program setting, and PID setting levels.
Setup area 1	This area groups together the initial setting, communications setting, advanced function setting, and calibration levels.

The variable type depends on the parameter. Refer to *3.1 Variable Area (Setting Range) List*.

The variable type is converted to 2-byte ASCII and loaded to the frame. The following table shows the available variable types.

Variable type	Description
C0/80	R/O (read only) parameter for setup area 0.
C1/81	R/W parameter for setup area 0.
C3/83	R/W parameter for setup area 1.
C4/84	R/W parameters for setup area 0 (program setting level, currently selected number).
C5/85	R/W parameter for setup area 0.
DA/9A	R/W parameters for setup area 0 (program setting level, all).

Note: Setup area 1 has no read-only parameters, so there is no variable type "C2."

## ■ Addresses

An address is appended to each of the variable types. Express addresses in 2-byte hexadecimal and append them for the specified access size. The address depends on the parameter. Refer to *3.1 Variable Area (Setting Range) List*.

## ■ Number of Elements

The number of elements is expressed in 2-byte hexadecimal. The range that can be specified for the number of elements depends on the command. Refer to *2.3 Detailed Description of the Services* for details.

## ■ List of Services

MRC	SRC	Name of service	Processing
01	01	Read Variable Area	This service reads from the variable area.
01	02	Write Variable Area	This service writes to the variable area.
01	04	Composite Read from Variable Area	This service reads from the variable area in the order specified by the parameters.

MRC	SRC	Name of service	Processing
01	13	Composite Write to Variable Area	This service writes to the variable area in the order specified by the parameters.
05	03	Read Controller Attributes	This service reads the model number and communications buffer size.
06	01	Read Controller Status	This service reads the operating status.
08	01	Echoback Test	This service performs an echoback test.
30	05	Operation Command	This service performs operations such as Run/Reset, executing/stopping AT (auto-tuning), and moving to Setup Area 1.

Note: No commands will be accepted and no responses will be returned when a memory error (RAM error) has occurred or the Controller is initializing (until the Controller recognizes the process value after the power is turned ON).

## 2.3 Detailed Description of the Services

### ■ Read Variable Area

This service reads data from the variable area.

Service Request PDU

MRC	SRC	Variable type	Read start address	Bit position	Number of elements
0   1	0   1			0   0	
2	2	2	4	2	4

Service Response PDU

MRC	SRC	Response code	Read data (for number of elements)
0   1	0   1		
2	2	4	Number of elements × 8 or 4

(1) Variable Type and Read Start Address

For details on variable types and read start addresses, see *SECTION 3 Communications Data for CompoWay/F*.

(2) Bit Position

The E5CN/AN/EN-HT does not support bit access. Fixed to “00.”

(3) Number of Elements

Number of elements	Processing
0000	The read operation is not performed (read data is not appended to the service response PDU), and processing ends in “normal completion.”
Double word (variable types C0, C1, C3, C4, C5, or DA)	0001 to 0019 (1 to 25) Up to 25 elements (H'19) are read, and processing ends in a normal completion.
Word (variable types 80, 81, 83, 84, 85, or 9A)	0001 to 0032 (1 to 50) Up to 50 elements (H'32) are read, and processing ends in a normal completion.

(4) Response Code

Normal Completion

Response code	Name	Description
0000	Normal completion	No errors were found.

Error Occurred

(5) Precautions

- Alarm Function

Response code	Error name	Cause
1001	Command too long	The command is too long.
1002	Command too short	The command is too short.
1101	Area type error	The variable type is wrong.
1103	Start address out-of-range error	The read start address is out of range.
110B	Response too long	The number of elements exceeds the maximum.
1100	Parameter error	Bit position is not "00."
2203	Operation error	Non-volatile memory error

Even though alarms are not displayed on the Controller's display, they function normally in communications.

## ■ Write Variable Area

This service writes data to the variable area.

### Service Request PDU

MRC	SRC	Variable type	Start write address	Bit position	Number of elements	Write Data (for number of elements)
0   1	0   2			0   0		
2	2	2	4	2	4	Number of elements × 8 or 4

### Service Response PDU

MRC	SRC	Response code
0   1	0   2	
2	2	4

#### (1) Variable Type and Write Start Address

For details on variable types and write start addresses, see *SECTION 3 Communications Data for CompoWay/F*.

#### (2) Bit Position

The E5CN/AN/EN-HT does not support bit access. Fixed to "00."

## (3) Number of Elements

Number of elements		Processing
0000		The write operation is not performed (do not append write data to the service request PDU) and processing ends in "normal completion."
Double word (variable types C0, C1, C3, C4, C5, or DA)	0001 to 0018 (1 to 24)	Up to 24 elements (H'18) are written, and processing ends in a normal completion.
Word (variable types 80, 81, 83, 84, 85, or 9A)	0001 to 0030 (1 to 48)	Up to 48 elements (H'30) are written, and processing ends in a normal completion.

## (4) Response Code

## Normal Completion

Response code	Name	Description
0000	Normal completion	No errors were found.

## Error Occurred

Response code	Error name	Cause
1002	Command too short	The command is too short.
1101	Area type error	The variable type is wrong.
1103	Start address out-of-range error	Write start address is out of range.
1104	End address out-of-range error	The write end address (write start address + number of elements) exceeds the final address of the variable area.
1003	Number of elements/data mismatch	The number of data does not match the number of elements.
1100	Parameter error	<ul style="list-style-type: none"> <li>• Bit position is not "00."</li> <li>• The write data is out of the setting range.</li> </ul>
3003	Read-only error	Variable type "C0" or "80" was written to.
2203	Operation error	<ul style="list-style-type: none"> <li>• The Communications Writing parameter is set to "OFF" (disabled).</li> <li>• Attempted to write to a parameter in setup area 1 from setup area 0.</li> <li>• Attempted to write to a protect parameter from other than the protect level.</li> <li>• AT (auto-tuning) was in progress. (See note.)</li> <li>• Non-volatile memory error.</li> <li>• The program number was written during operation.</li> </ul>

Note: For details on AT (auto-tuning), refer to the separate *E5CN/AN/EN-HT Digital Controllers Program Type User's Manual* (Cat. No. H169).

(5) Precautions

● Alarm Function

Even though alarms are not displayed on the Controller's display, they function normally in communications.

## ■ Composite Read from Variable Area

This service reads in order the contents of specified addresses in the variable area.

### Service Request PDU



### Service Response PDU

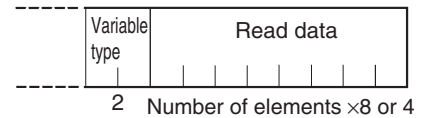
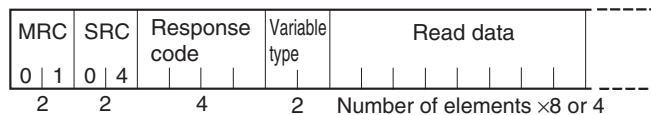

Note: The read data is read together with the variable type in the order specified by the command.

(1) Variable Type and Read Start Address

For details on variable types and read start addresses, see *SECTION 3 Communications Data for CompoWay/F*.

(2) Bit Position

The E5CN/AN/EN-HT does not support bit access. Fixed to "00."

(3) Number of Read Data Items (Variable Type + Read Data)

Read data length	Number of read data items
Double word (variable types C0, C1, C3, C4, C5, or DA)	20 max.
Word (variable types 80, 81, 83, 84, 85, or 9A)	25 max.

Note: The maximum number of data that can be read when double-word data and word data are mixed is given in the following table.

Composite read		Composite read	
Double word (variable types C0, C1, C3, C4, C5, or DA)	Word (variable types 80, 81, 83, 84, 85, or 9A)	Double word (variable types C0, C1, C3, C4, C5, or DA)	Word (variable types 80, 81, 83, 84, 85, or 9A)
20	0	9	16
19	1	8	17
18	3	7	18
17	5	6	19
16	6	5	20
15	8	4	21
14	10	3	22
13	11	2	23
12	13	1	24
11	14	0	25
10	15		

#### (4) Response Code

##### Normal Completion

Response code	Name	Description
0000	Normal completion	No errors were found.

##### Error Occurred

Response code	Error name	Cause
1002	Command too short	The command is too short.
1101	Area type error	The variable type is wrong.
110B	Response too long	The number of elements exceeds the maximum.
1100	Parameter error	Bit position is not "00."
2203	Operation error	Non-volatile memory error

## ■ Composite Write to Variable Area

This service writes in order the contents of specified addresses to a variable area.

Service Request PDU

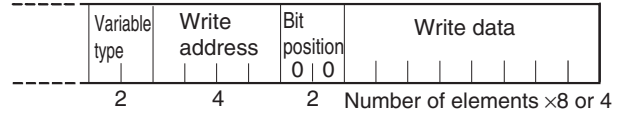
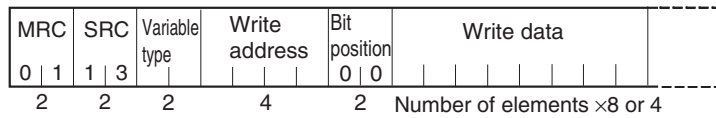

Service Response PDU

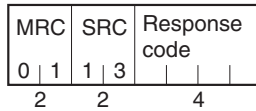

(1) Variable Type and Write Start Address

For details on variable types and write start addresses, see *SECTION 3 Communications Data for CompoWay/F*.

(2) Bit Position

The E5CN/AN/EN-HT does not support bit access. Fixed to “00.”

(3) Number of Write Data Items (Variable Type + Write Data)

Write data length	Number of write data items
Double word (variable types C0, C1, C3, C4, C5, or DA)	12 max.
Word (variable types 80, 81, 83, 84, 85, or 9A)	17 max.

Note: The maximum number of data that can be written when double-word data and word data are mixed is given in the following table.

Composite write		Composite write	
Double word (variable types C0, C1, C3, C4, C5, or DA)	Word (variable types 80, 81, 83, 84, 85, or 9A)	Double word (variable types C0, C1, C3, C4, C5, or DA)	Word (variable types 80, 81, 83, 84, 85, or 9A)
12	1	6	9
11	2	5	10
10	3	4	11
9	5	3	13
8	6	2	14
7	7	1	15
6	8	0	17



## (4) Response Code

## Normal Completion

Response code	Name	Description
0000	Normal completion	No errors were found.

## Error Occurred

Response code	Error name	Cause
1002	Command too short	The command is too short.
1101	Area type error	The variable type is wrong.
1100	Parameter error	<ul style="list-style-type: none"> <li>• Bit position is not "00."</li> <li>• The write data is out of the setting range.</li> </ul>
3003	Read-only error	Variable type "C0" or "80" was written to.
2203	Operation error	<ul style="list-style-type: none"> <li>• The Communications Writing parameter is set to "OFF" (disabled).</li> <li>• Attempted to write to a parameter in setup area 1 from setup area 0.</li> <li>• Attempted to write to a protect parameter from other than the protect level.</li> <li>• AT (auto-tuning) was in progress. (See note.)</li> <li>• Non-volatile memory error.</li> <li>• The program number was written during operation.</li> </ul>

Note: For details on AT (auto-tuning), refer to the separate *E5CN/AN/EN-HT Digital Controllers Program Type User's Manual* (Cat. No. H169).

## ■ Read Controller Attributes

This service reads the model number and communications buffer size.

### Service Request PDU

MRC	SRC
0   5	0   3
2	2

### Service Response PDU

MRC	SRC	Response code	Model No.	Buffer size
0   5	0   3			0   0   D   9
2	2	4	10	4

#### (1) Model Number

The model number is expressed in 10-byte ASCII. When 10 bytes are not required, pad the remaining bytes with spaces.

Example: The following model number is used for the E5CN-HTQ2HH03-FLK (voltage output, two auxiliary outputs, two heater burnout detection inputs, and communications).

E	5	C	N	-	H	T	Q	2	H	H
---	---	---	---	---	---	---	---	---	---	---

#### (2) Buffer Size

The communications buffer size is expressed in 2-byte hexadecimal, and read after being converted to 4-byte ASCII.

Buffer size: 217 bytes (= H'00D9)

#### (3) Response Code

Normal Completion

Response code	Name	Description
0000	Normal completion	No errors were found.

Error Occurred

Response code	Name	Description
1001	Command too long	The command is too long.
2203	Operation error	Non-volatile memory error

## ■ Read Controller Status

This service reads the operating status and error status.

Service Request PDU

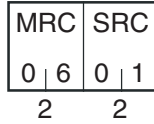

Service Response PDU



(1) Operating Status

Operating status	Description
01	Control is not being performed (the manual MV, MV at reset, or MV at error from setup area 1 is being output).
00	Control is being carried out (state other than the above).

(2) Related Information

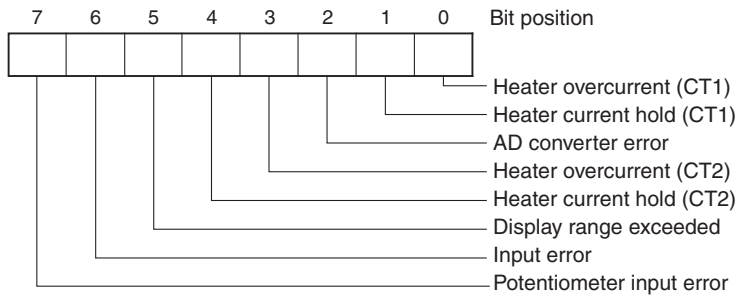

(3) Response Code

Normal Completion

Response code	Name	Description
0000	Normal completion	No errors were found.

Error Occurred

Response code	Name	Description
1001	Command too long	The command is too long.
2203	Operation error	Non-volatile memory error

## ■ Echoback Test

This service performs an echoback test.

### Service Request PDU

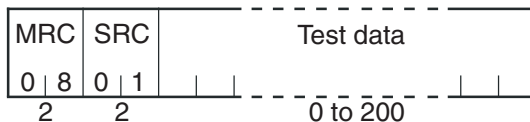

### Service Response PDU

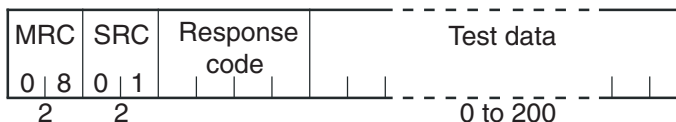

#### (1) Test Data

Set between 0 and 200 bytes of user-defined test data.

Set a value for the test data within the ranges shown below according to the communications data length.

Communications data length	Test Data
8 bits	ASCII data: H'20 to H'7E or H'A1 to H'FE
7 bits	ASCII data: H'20 to H'7E

Do not set the value H'40. No response will be returned.

#### (2) Response Code

Normal Completion

Response code	Name	Description
0000	Normal completion	No errors were found.

Error Occurred

Response code	Name	Description
1001	Command too long	The command is too long.
2203	Operation error	Non-volatile memory error

## ■ Operation Command

This service performs operations such as the following:

- Communications Writing
- Write Mode
- Move to Setup Area 1
- Parameter Initialization
- Invert Direct/Reverse Operation
- Advance
- Run/Reset
- Save RAM Data
- Move to Protect Level
- Alarm Latch Cancel
- Infrared Communication Use
- AT Execute/Cancel
- Software Reset
- Auto/Manual Switch
- SP Mode
- Hold

### Service Request PDU

MRC	SRC	Com- mand code	Related informa- tion
3   0	0   5		
2	2	2	2

### Service Response PDU

MRC	SRC	Response code
3   0	0   5	
2	2	4

(1) Command Code and Related Information

Command code	Command content	Related Information
00	Communications Writing	00: OFF (disabled) 01: ON (enabled)
01	Run/Reset	00: Run 01: Reset
03	AT Execute/Cancel	00: AT cancel 01: 100% AT execute 02: 40% AT execute
04	Write Mode	00: Backup mode 01: RAM write mode
05	Save RAM Data	00
06	Software Reset	00
07	Move to Setup Area 1	00
08	Move to Protect Level	00
09	Auto/Manual Switch	00: Automatic mode 01: Manual mode
0B	Parameter Initialization	00: Initialize to defaults

Command code	Command content	Related Information
0C	Alarm Latch Cancel	00: Alarm 1 latch cancel 01: Alarm 2 latch cancel 02: Alarm 3 latch cancel 03: HB alarm latch cancel 04: HS alarm latch cancel 05: OC alarm latch cancel 0F: All alarm latch cancel
0D	SP Mode	00: Program SP Mode 01: Remote SP Mode 02: Fixed SP Mode
0E	Invert Direct/Reverse Operation	00: Not invert 01: Invert
12	Infrared Communication Use	00: OFF 01: ON
13	Hold	00: Clear hold 01: Hold
14	Advance	00

(2) Response Code  
Normal Completion

Response code	Name	Description
0000	Normal completion	No errors were found.

Error Occurred

Response code	Error name	Cause
1001	Command too long	The command is too long.
1002	Command too short	The command is too short.
1100	Parameter error	Command code and related information are wrong.
2203	Operation error	<ul style="list-style-type: none"> <li>The Communications Writing parameter is set to "OFF" (disabled). The command is received regardless of the Communications Writing parameter setting (ON/OFF).</li> <li>Processing could not be performed. For details, see (3) <i>Operation Commands and Precautions</i> below.</li> <li>Non-volatile memory error</li> </ul>

### (3) Operation Commands and Precautions

#### ● Communications Writing

Set the Communications Writing parameter to “ON: enabled” or “OFF: disabled” with the related information setting. The setting can be accepted in both setup area 0 and setup area 1. An operation error will occur, however, if enabling or disabling communications writing is set for an event input.

#### ● Run/Reset

Set control to “run” or “stop” with the related information setting. The setting can be accepted in both setup area 0 and setup area 1.

#### ● AT Execute/Cancel

Set AT (auto-tuning) to “execute” or “cancel” with the related information setting. This command can be accepted in setup area 0 only. An “operation error” will be generated in the following instances:

- When the Run/Reset parameter is set to Reset (and the reset operation is set to stop control).
- During standby status (when the reset operation is set to stop control).
- During manual operation or when executing from setup area 1.
- When ON/OFF control is being used
- When 40% AT is specified during 100% AT execution.
- When 100% AT is specified during 40% AT execution.
- When 100% AT execute/cancel or 40% AT execute/cancel is assigned to an event input.

In addition, a parameter error will occur if 40% AT is specified during heating and cooling control or during position-proportional floating control.

**Note:** If the same type of AT execution is specified during AT execution (e.g., if 100% AT is specified during 100% AT execution), the AT will not be restarted and the operation will end in normal completion with no processing.

#### ● Write Mode

Set either the backup mode or RAM write mode with the related information setting. The setting can be accepted in both setup area 0 and setup area 1.

The number of non-volatile memory write operations is limited. Therefore, use RAM write mode when frequently overwriting data.

Write mode	Description
Backup mode	The data is written to non-volatile memory when a parameter in the operation, program setting, adjustment, or PID setting level (excluding read-only parameters) is written using communications.
RAM write mode	The data is not written to non-volatile memory when a parameter in the operation, program setting, adjustment, or PID setting level (excluding read-only parameters) is written using communications. Parameters can be changed by using key operations on the front panel of the Controller.

- When the mode is changed from RAM write mode to backup mode, the parameters in the operation, program setting, adjustment, or PID setting level (excluding read-only parameters) are written to non-volatile memory.
- RAM write mode is enabled only when communications are enabled in the Communications Writing parameter (i.e., set to ON). Therefore, if the Communications Writing parameter is changed to OFF (disabled), the parameter settings from the operation, program setting, adjustment, and PID setting levels (excluding read-only parameters) are written to non-volatile memory even if the RAM write mode is set.

#### ● Save RAM Data

This command writes the parameters in the operation, program setting, adjustment, or PID setting levels (excluding read-only parameters) to non-volatile memory. The setting can be made in either setup area 0 or setup area 1.

#### ● Software Reset

Restarts processing from the point when power is turned ON. The setting can be accepted in both setup area 0 and setup area 1.

#### ● Move to Setup Area 1

This command moves to “setup area 1” and can be accepted at both setup areas 0 and 1. If the “initial setting/communications protect” is set to “2,” an “operation error” will be generated, and the move to setup area 1 will be prohibited.

When this move is carried out from setup area 0, the display indicates the Input Type parameter in the “initial setting level.” When this operation command is executed in setup area 1, the display will not change.



- Move to Protect Level

This command moves to the “protect level” and can be accepted only in setup area 0. When this command is issued in setup area 1, an “operation error” will be generated, and the move to the protect level will be prohibited.

- ◆ Moving to Protect Level in Manual Mode

When this operation command is issued in manual mode, an “operation error” will be generated, and the move to the protect level will be prohibited.

- Auto/Manual Switch

This operation command switches the mode to manual mode or automatic mode, based on the related information setting. This command can be accepted in setup area 0 only. An “operation error” will be generated in the following instances:

- When the command is executed in “setup area 1”
- When auto/manual switching is disabled (not displayed)

When the Controller is switched to manual mode, the “manual manipulated variable” will be displayed. When the Controller is switched from manual mode to automatic mode, the operation level’s first parameter will be displayed. When the Controller is switched to manual mode while already in manual mode, the command will be completed normally and the display will not change (the contents will not be refreshed).

Note: When the auto/manual mode is switched with an operation command through communications and the Controller is in RAM write mode, the auto/manual status is not stored in non-volatile memory. Consequently, if the Controller is restarted by performing a software reset or turning the power OFF and ON again, the auto/manual mode is set to the last saved status.

- ◆ Switching to Manual Mode during Auto-tuning

If the mode is switched during auto-tuning (AT), the AT will be cancelled and the Controller will be switched to manual mode.

- Parameter Initialization

The present settings are returned to the default values and written to non-volatile memory. This command can be accepted in setup area 1 only. When this command is issued in setup area 0, an “operation error” will be generated.

Related information	Explanation (initialization values)
00	Default initialization values (See <i>SECTION 3 Communications Data for CompoWay/F</i> for details.) (These settings are the same as the ones used when “FACT” is selected for the setting data’s set value initialization.)

● Alarm Latch Cancel

The applicable alarm latch can be cleared with the related information setting. The setting can be accepted in both setup area 0 and setup area 1. An operation error will occur if communications writing is disabled or if a non-volatile memory error occurs.

● SP Mode

Select program SP mode, remote SP mode, or fixed SP mode with the related information setting. The setting can be accepted in both setup area 0 and setup area 1. An operation error will occur in the following situations.

- When AT is being executed.
- When the SP Mode parameter is disabled (not displayed at the Controller).

● Invert Direct/Reverse Operation

Inverting or not inverting direct/reverse operation can be selected with the related information setting. The setting can be accepted in both setup area 0 and setup area 1. The related information specifications are written to non-volatile memory according to the write mode settings. An operation error will occur in the following situations:

- When AT is being executed.
- When inverting direct/reverse operation is set for an event input.
- When executed in manual mode.

● Infrared Communications Use

Select ON or OFF to enable or disable using infrared communications with the related information setting. The setting can be accepted in both setup area 0 and setup area 1.

● Hold

Turn the hold operation ON or OFF with the related information setting. The setting can be made only in setup area 0. An operation error will occur in the following situations.

- When AT is being executed
- During standby status

- During a reset or when continuing control at the end of operation
- When Hold/Clear Hold is assigned to an event input

#### ● Advance

This operation command performs the advance operation. The setting can be made only in setup area 0. An operation error will occur in the following situations.

- When AT is being executed
- During standby status
- During a reset or when continuing control at the end of operation

#### ● Setting Areas

Control operation is executed in setting area 0. In this state, you can perform operations that are permitted only during control or those that cause no problems even if control is in progress. These operations include reading PVs, writing SPs, and change Run/Reset status.

Setting area 0, however, prohibits operations that affect control, including writing data at the initial setting level. (Reading setting data is always allowed.)

In setting area 1, control operation is stopped. In this state, you can perform operations that are not allowed in setting area 0. These operations include writing data at the initial setting level.

At power-ON, the Digital Controller is set in setting area 0. To move to setting area 1, use the “move-to-setting area 1” command. To return to setting area 0, turn the power OFF and ON again, or use the “software reset” command.

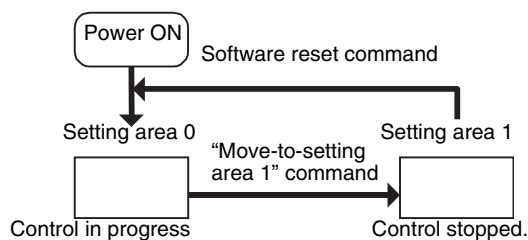

## 2.4 Response Code List

### Normal Completion

Response code	Name	Description	Error detection priority
0000	Normal completion	No errors were found.	None

### Error Occurred

Response code	Name	Description	Error detection priority
0401	Unsupported command	The service function for the relevant command is not supported.	1
1001	Command too long	The command is too long.	2
1002	Command too short	The command is too short.	3
1101	Area type error	Wrong variable type	4
1103	Start address out-of-range error	The read/write start address is out of range.	5
1104	End address out-of-range error	The write end address (write start address + number of elements) exceeds the final address of the variable area.	6
1003	Number of elements/data mismatch	The amount of data does not match the number of elements.	7
110B	Response too long	The response length exceeds the communications buffer size (when the number of elements is greater than the maximum number of elements for that service).	8
1100	Parameter error	<ul style="list-style-type: none"> <li>• Bit position is not "00."</li> <li>• The write data is out of the setting range.</li> <li>• The command code or related information in the operation command is wrong.</li> </ul>	9
3003	Read-only error	Variable type "C0" or "80" was written to.	10
2203	Operation error	<ul style="list-style-type: none"> <li>• The Communications Writing parameter is set to "OFF" (disabled).</li> <li>• Attempted to write to a parameter in setup area 1 from setup area 0.</li> <li>• Attempted to write to a protect parameter from other than the protect level.</li> <li>• Writing was carried out during AT execution.</li> <li>• Processing is not possible by operation command.</li> <li>• Non-volatile memory error.</li> <li>• The program number was written during operation.</li> </ul>	11

# SECTION 3

## Communications Data for CompoWay/F

This section gives the details of the communications data in the CompoWay/F communications protocol.

3.1	Variable Area (Setting Range) List .....	3-2
3.2	Status and Status 2 .....	3-20
	Status Structure .....	3-20
	Status 2 Structure .....	3-22
	Status Details .....	3-23
	Status 2 Details .....	3-24

### 3.1 Variable Area (Setting Range) List

For communications using a variable type not enclosed in parentheses in the following table, the set value is double-word data (8 digits). For communications using a variable type enclosed in parentheses, the set value is single-word data (4 digits).

For example, variable type C0 is double-word data (8 digits), and variable type 80 is single-word data (4 digits).

Items expressed in hexadecimal in the “Set (monitor) value” column are the setting range for CompoWay/F communications. The values in parentheses are the actual setting range. When there is a section reference for a setting item, refer to that reference for details.

Variable type	Address	Parameter name	Setting (monitor) value	Level	
C0 (80)	0000	Process Value	Temperature: Use the specified range for each sensor. Analog: Scaling lower limit -5% FS to Scaling upper limit +5% FS	Operation	
C0 (80)	0001	Status (See notes 1 and 2.)	See 3.2 Status and Status 2 for details.	None	
C0 (80)	0002	Present SP	SP lower limit to SP upper limit		
C0 (80)	0003	Heater Current 1 Value Monitor	H'00000000 to H'00000226 (0.0 to 55.0)	Operation	
C0 (80)	0004	MV Monitor (Heating)	Standard: H'FFFFFFCE to H'0000041A (-5.0 to 105.0) Heating/cooling: H'00000000 to H'0000041A (0.0 to 105.0)		
C0 (80)	0005	MV Monitor (Cooling)	H'00000000 to H'0000041A (0.0 to 105.0)		
C0 (80)	0006	Heater Current 2 Value Monitor	H'00000000 to H'00000226 (0.0 to 55.0)		
C0 (80)	0007	Leakage Current 1 Monitor	H'00000000 to H'00000226 (0.0 to 55.0)		
C0 (80)	0008	Leakage Current 2 Monitor	H'00000000 to H'00000226 (0.0 to 55.0)		
C0 (80)	000A	Valve Opening Monitor	H'FFFFFF9C to H'0000044C (-10.0 to 110.0)		
C0 (80)	000B	Remote SP Monitor	SP Lower Limit to SP Upper Limit		
C0 (80)	000D	PID Set No. Monitor	H'00000001 to H'00000008 (1 to 8)		None
C0 (80)	000E	Decimal Point Monitor (See note 1.)	H'00000000 to H'00000003 (0 to 3)		
C0 (80)	000F	Control Output 1 ON/OFF Count Monitor	H'00000000 to H'0000270F (0 to 9999)	Advanced function setting	
C0 (80)	0010	Control Output 2 ON/OFF Count Monitor	H'00000000 to H'0000270F (0 to 9999)		
C0 (80)	0011	Status 2 (See notes 1 and 2.)	Refer to 3.2 Status and Status 2.	None	
C0 (80)	0012	Status (See notes 1 and 3.)	Refer to 3.2 Status and Status 2.		
C0 (80)	0013	Status 2 (See notes 1 and 3.)	Refer to 3.2 Status and Status 2.		
C0 (80)	0014	Program No. Monitor	H'00000000 to H'00000007 (0 to 7)	Operation	
C0 (80)	0015	Segment No. Monitor	H'00000000 to H'0000001F (0 to 31)		
C0 (80)	0016	Remaining Standby Time Monitor	H'00000000 to H'00009959 (hours, minutes) H'00000000 to H'00009923 (days, hours)		
C0 (80)	0017	Elapsed Program Time Monitor	H'00000000 to H'00009959		
C0 (80)	0018	Remaining Program Time Monitor	H'00000000 to H'00009959	None	
C0 (80)	0019	Elapsed Segment Time Monitor	H'00000000 to H'00009959		
C0 (80)	001A	Remaining Segment Time Monitor	H'00000000 to H'00009959		
C0 (80)	001B	Program Repetitions Monitor	H'00000000 to H'0000270F (0 to 9999)	Operation	
C0 (80)	001C	SP Mode Setting Monitor	H'00000000(0): Program SP mode H'00000001(1): Remote SP mode H'00000002(2): Fixed SP mode	None	

Note 1: Not displayed on the Controller display.

Note 2: When the variable type is 80 (word access), the rightmost 16 bits are read.

Note 3: When the variable type is 80 (word access), the leftmost 16 bits are read.

Note 4: If the Run/Reset parameter is set to Run, the current program number will be read.

If the Run/Reset parameter is set to Reset, the program number that is set in the Program No. parameter will be read.

Variable type	Address	Parameter name	Setting (monitor) value	Level
C1 (81)	0000	Operation/Adjustment Protect	H'00000000(0) to H'00000005(5) 0: No control 1: Run level (PV allowed, PV/SP allowed, others allowed), program level allowed, adjustment level allowed, PID setting level prohibited 2: Run level (PV allowed, PV/SP allowed, others allowed), program level allowed, adjustment level prohibited, PID setting level prohibited 3: Run level (PV allowed, PV/SP allowed, others allowed), program level prohibited, adjustment level prohibited, PID setting level prohibited 4: Run level (PV allowed, PV/SP allowed, others prohibited), program level prohibited, adjustment level prohibited, PID setting level prohibited 5: Run level (PV allowed, PV/SP prohibited, others prohibited), program level prohibited, adjustment level prohibited, PID setting level prohibited	Protect
C1 (81)	0001	Initial Setting/Communications Protect	H'00000000 (0): Move to initial setting/communications setting level is allowed. (Move to advanced function setting level is displayed.) H'00000001 (1): Move to initial setting/communications setting level is allowed. (Move to advanced function setting level is not displayed.) H'00000002 (2): Move to initial setting/communications setting level is prohibited.	
C1 (81)	0002	Setting Change Protect	H'00000000 (0): OFF (Changing of setup on Controller display is allowed.) H'00000001 (1): ON (Changing of setup on Controller display is prohibited.)	
C1 (81)	0003	Set Point (See note 1.)	SP lower limit to SP upper limit	Operation
C1 (81)	000D	Heater Burnout Detection 1	H'00000000 to H'000001F4 (0.0 to 50.0)	Adjustment
C1 (81)	0012	Temperature Input Shift	H'FFFFB1E1 to H'00007E90 (-199.99 to 324.00)	
C1 (81)	0013	Upper Limit Temperature Input Shift Value	H'FFFFB1E1 to H'00007E90 (-199.99 to 324.00)	
C1 (81)	0014	Lower Limit Temperature Input Shift Value	H'FFFFB1E1 to H'00007E90 (-199.99 to 324.00)	
C1 (81)	0015	Proportional Band (See note 2.)	Temperature: H'00000001 to H'00007E90 (0.1 to 3240.0) Analog: H'00000001 to H'0000270F (0.1 to 999.9)	
C1 (81)	0016	Integral Time (See note 2.)	Standard, heating/cooling, positional proportional (closed): H'00000000 to H'00007E90 (0.0 to 3240.0) Positional proportional (floating): H'00000001 to H'00007E90 (0.1 to 3240.0)	
C1 (81)	0017	Derivative Time (See note 2.)	H'00000000 to H'00007E90 (0.0 to 3240.0)	
C1 (81)	0018	Cooling Coefficient (See note 2.)	H'00000001 to H'0000270F (0.01 to 99.99)	
C1 (81)	0019	Dead Band	Temperature: H'FFFFB1E1 to H'00007E90 (-1999.9 to 3240.0) Analog: H'FFFFF831 to H'0000270F (-19.99 to 99.99)	
C1 (81)	001A	Manual Reset Value	H'00000000 to H'000003E8 (0.0 to 100.0)	
C1 (81)	001B	Hysteresis (Heating)	Temperature: H'00000001 to H'00007E90 (0.1 to 3240.0) Analog: H'00000001 to H'0000270F (0.01 to 99.99)	
C1 (81)	001C	Hysteresis (Cooling)	Temperature: H'00000001 to H'00007E90 (0.1 to 3240.0) Analog: H'00000001 to H'0000270F (0.01 to 99.99)	
C1 (81)	001D	Heater Burnout Detection 2	H'00000000 to H'000001F4 (0.0 to 50.0)	
C1 (81)	001E	HS Alarm 1	H'00000000 to H'000001F4 (0.0 to 50.0)	
C1 (81)	001F	HS Alarm 2	H'00000000 to H'000001F4 (0.0 to 50.0)	
C1 (81)	0021	Wait Band	H'00000000(0): OFF Temperature: H'00000001 to H'00007E90 (0.1 to 3240.0) Analog: H'00000001 to H'0000270F (0.01 to 99.99)	

Note 1: This is a read-only parameter. To change the SP, edit the SP parameter for the SP mode.

- Program SP (PSP): C4 (84), segment SP at 0004 or segment SP for each program under DA (9A)
- Fixed SP (FSP): C1 (81), Fixed SP at 0033

Note 2: The parameter for the currently selected PID set will be accessed. For setup area 1, however, the currently selected PID set is fixed at PID1.

SECTION 3 Communications Data for CompoWay/F

Com Data for CompoWay/F

Variable type	Address	Parameter name	Setting (monitor) value	Level
C1 (81)	0022	MV at Reset	Standard: H'FFFFFFCE to H'0000041A (-5.0 to 105.0) Heating/cooling: H'FFFFFFBE6 to H'0000041A (-105.0 to 105.0) Position proportional (Floating or direct setting of position proportional MV OFF): H'FFFFFFF to H'00000001 (-1 to 1) Position proportional (Closed and direct setting of position proportional MV ON): H'FFFFFFCE to H'0000041A (-5.0 to 105.0)	Adjustment
C1 (81)	0023	MV at PV Error	Standard: H'FFFFFFCE to H'0000041A (-5.0 to 105.0) Heating/cooling: H'FFFFFFBE6 to H'0000041A (-105.0 to 105.0) Position proportional (Floating or direct setting of position proportional MV OFF): H'FFFFFFF to H'00000001 (-1 to 1) Position proportional (Closed and direct setting of position proportional MV ON): H'FFFFFFCE to H'0000041A (-5.0 to 105.0)	Adjustment
C1 (81)	0024	Manual MV	Standard: H'FFFFFFCE to H'0000041A (-5.0 to 105.0) Heating/cooling: H'FFFFFFBE6 to H'0000041A (-105.0 to 105.0) Position proportional (Floating or direct setting of position proportional MV OFF): H'FFFFFFF to H'00000001 (-1 to 1) Position proportional (Closed and direct setting of position proportional MV ON): H'FFFFFFCE to H'0000041A (-5.0 to 105.0)	Manual Control
C1 (81)	0026	MV Upper Limit (See note 1.)	Standard: MV lower limit + 0.1 to H'0000041A (MV lower limit + 0.1 to 105.0) Heating/cooling: H'00000000 to H'0000041A (0.0 to 105.0) Position proportional (closed): MV lower limit +0.1 to H'0000041A (MV lower limit +0.1 to 105.0)	Adjustment
C1 (81)	0027	MV Lower Limit (See note 1.)	Standard: H'FFFFFFCE to MV upper limit -0.1 (-5.0 to MV upper limit -0.1) Heating/cooling: H'FFFFFFBE6 to H'00000000 (-105.0 to 0.0) Position proportional (closed): H'FFFFFFCE to MV upper limit -0.1 (-5.0 to MV upper limit -0.1)	Adjustment
C1 (81)	0028	Move to Protect Level	H'FFFFFF831 to H'0000270F (-1999 to 9999)	Protect
C1 (81)	0029	Password to Move to Protect Level	H'FFFFFF831 to H'0000270F (-1999 to 9999) (Can only be set. The monitor value is always H'00000000.)	
C1 (81)	002A	Parameter Mask Enable	H'00000000 (0): OFF H'00000001 (1): ON	
C1 (81)	002B	PF Key Protect	H'00000000 (0): OFF H'00000001 (1): ON	
C1 (81)	002C	MV Change Rate Limit	H'00000000 to H'000003E8 (0.0 to 100.0)	Adjustment
C1 (81)	002D	Position Proportional Dead Band	H'00000001 to H'00000064 (0.1 to 10.0)	
C1 (81)	002E	Open/Close Hysteresis	H'00000001 to H'000000C8 (0.1 to 20.0)	
C1 (81)	002F	Heater Overcurrent Detection 1	H'00000000 to H'000001F4 (0.0 to 50.0)	
C1 (81)	0030	Heater Overcurrent Detection 2	H'00000000 to H'000001F4 (0.0 to 50.0)	
C1 (81)	0031	Extraction of Square Root Low-cut Point	H'00000000 to H'000003E8 (0.0 to 100.0)	
C1 (81)	0032	Program No.	H'00000000 to H'00000007 (0 to 7)	
C1 (81)	0033	Fixed SP	SP lower limit to SP upper limit	Adjustment
C1 (81)	0034	Standby Time	H'00000000 to H'00009959 (hours, minutes) H'00000000 to H'00009923 (days, hours)	
C1 (81)	0035	Program SP Shift Value	H'FFFFFFB1E1 to H'00007E90 (-19999 to 32400)	
C1 (81)	0036	RSP 0 before Correction	Remote SP lower limit to remote SP upper limit	
C1 (81)	0037	RSP 1 before Correction	Remote SP lower limit to remote SP upper limit	
C1 (81)	0038	RSP 2 before Correction	Remote SP lower limit to remote SP upper limit	
C1 (81)	0039	RSP 3 before Correction	Remote SP lower limit to remote SP upper limit	
C1 (81)	003A	RSP 4 before Correction	Remote SP lower limit to remote SP upper limit	
C1 (81)	003B	RSP 5 before Correction	Remote SP lower limit to remote SP upper limit	
C1 (81)	003C	RSP 6 before Correction	Remote SP lower limit to remote SP upper limit	
C1 (81)	003D	RSP 7 before Correction	Remote SP lower limit to remote SP upper limit	
C1 (81)	003E	RSP 8 before Correction	Remote SP lower limit to remote SP upper limit	
C1 (81)	003F	RSP 9 before Correction	Remote SP lower limit to remote SP upper limit	
C1 (81)	0040	RSP 10 before Correction	Remote SP lower limit to remote SP upper limit	



Variable type	Address	Parameter name	Setting (monitor) value	Level
C1 (81)	0041	RSP Broken-line Correction Value 0	H'FFFFB1E1 to H'00007E90 (-19999 to 32400)	Adjustment
C1 (81)	0042	RSP Broken-line Correction Value 1	H'FFFFB1E1 to H'00007E90 (-19999 to 32400)	
C1 (81)	0043	RSP Broken-line Correction Value 2	H'FFFFB1E1 to H'00007E90 (-19999 to 32400)	
C1 (81)	0044	RSP Broken-line Correction Value 3	H'FFFFB1E1 to H'00007E90 (-19999 to 32400)	
C1 (81)	0045	RSP Broken-line Correction Value 4	H'FFFFB1E1 to H'00007E90 (-19999 to 32400)	
C1 (81)	0046	RSP Broken-line Correction Value 5	H'FFFFB1E1 to H'00007E90 (-19999 to 32400)	
C1 (81)	0047	RSP Broken-line Correction Value 6	H'FFFFB1E1 to H'00007E90 (-19999 to 32400)	
C1 (81)	0048	RSP Broken-line Correction Value 7	H'FFFFB1E1 to H'00007E90 (-19999 to 32400)	
C1 (81)	0049	RSP Broken-line Correction Value 8	H'FFFFB1E1 to H'00007E90 (-19999 to 32400)	
C1 (81)	004A	RSP Broken-line Correction Value 9	H'FFFFB1E1 to H'00007E90 (-19999 to 32400)	
C1 (81)	004B	RSP Broken-line Correction Value 10	H'FFFFB1E1 to H'00007E90 (-19999 to 32400)	

Note 1: The parameter for the currently selected PID set will be accessed. For setup area 1, however, the currently selected PID set is fixed at PID1.

SECTION 3 Communications Data for CompoWay/F

Com Data for CompoWay/F

Variable type	Address	Parameter name	Setting (monitor) value	Level
C3 (83)	0000	Input Type (See note.)	H'00000000 (0): Pt (-200.0 to 850.0°C/-300.0 to 1500.0°F) H'00000001 (1): Pt (-199.9 to 500.0°C/-199.9 to 900.0°F) H'00000002 (2): Pt (0.0 to 100.0°C/0.0 to 210.0°F) H'00000003 (3): JPt (-199.9 to 500.0°C/-199.9 to 900.0°F) H'00000004 (4): JPt (0.0 to 100.0°C/0.0 to 210.0°F) H'00000005 (5): K (-200.0 to 1300.0°C/-300.0 to 2300.0°F) H'00000006 (6): K (-20.0 to 500.0°C/0.0 to 900.0°F) H'00000007 (7): J (-100.0 to 850.0°C/-100.0 to 1500.0°F) H'00000008 (8): J (-20.0 to 400.0°C/0.0 to 750.0°F) H'00000009 (9): T (-200.0 to 400.0°C/-300.0 to 700.0°F) H'0000000A (10): T (-199.9 to 400.0°C/-199.9 to 700.0°F) H'0000000B (11): E (-200.0 to 600.0°C/-300.0 to 1100.0°F) H'0000000C (12): L (-100.0 to 850.0°C/-100.0 to 1500.0°F) H'0000000D (13): U (-200.0 to 400.0°C/-300.0 to 700.0°F) H'0000000E (14): U (-199.9 to 400.0°C/-199.9 to 700.0°F) H'0000000F (15): N (-200.0 to 1300.0°C/-300.0 to 2300.0°F) H'00000010 (16): R (0.0 to 1700.0°C/0.0 to 3000.0°F) H'00000011 (17): S (0.0 to 1700.0°C/0.0 to 3000.0°F) H'00000012 (18): B (100.0 to 1800.0°C/300.0 to 3200.0°F) H'00000013 (19): W (0.0 to 2300.0°C/0.0 to 3200.0°F) H'00000014 (20): PLII (0.0 to 1300.0°C/0.0 to 2300.0°F) H'00000015 (21): K (-50.00 to 200.00°C/-50.00 to 200.00°F) H'00000016 (22): J (-50.00 to 200.00°C/-50.00 to 200.00°F) H'00000017 (23): T (-50.00 to 200.00°C/-50.00 to 200.00°F) H'00000018 (24): Pt (-50.00 to 200.00°C/-50.00 to 200.00°F) H'00000019 (25): 4 to 20 mA H'0000001A (26): 0 to 20 mA H'0000001B (27): 1 to 5 V H'0000001C (28): 0 to 5 V H'0000001D (29): 0 to 10 V	Initial setting
C3 (83)	0001	Scaling Upper Limit	Scaling lower limit +1 to H'00007E90 (Scaling lower limit +1 to 32400)	
C3 (83)	0002	Scaling Lower Limit	H'FFFFB1E1 to scaling upper limit -1 (-19,999 to scaling upper limit -1)	
C3 (83)	0003	Decimal Point	H'00000000 to H'00000003 (0 to 3)	
C3 (83)	0004	Temperature Unit	H'00000000 (0): °C H'00000001 (1): °F	
C3 (83)	0005	SP Upper Limit	The range of values (without decimal point) is as follows: Temperature: SP lower limit + 1 to input setting range upper limit Analog: SP lower limit + 1 to Scaling upper limit	
C3 (83)	0006	SP Lower Limit	The range of values (without decimal point) is as follows: Temperature: Input setting range lower limit to SP upper limit -1 Analog: Scaling lower limit to SP upper limit -1	
C3 (83)	0007	PID ON/OFF	H'00000000 (0): ON/OFF H'00000001 (1): 2 PID control	
C3 (83)	0008	Standard or Heating/Cooling	H'00000000 (0): Standard H'00000001 (1): Heating/cooling	
C3 (83)	000A	Control Period (Heating)	H'00000000 (0): 0.5 H'00000001 to H'00000063 (1 to 99)	
C3 (83)	000B	Control Period (Cooling)	H'00000000 (0): 0.5 H'00000001 to H'00000063 (1 to 99)	
C3 (83)	000C	Direct/Reverse Operation	H'00000000 (0): Reverse operation H'00000001 (1): Direct operation	

Note: The input type can be selected to match the connected sensor.

Variable type	Address	Parameter name	Setting (monitor) value	Level
C3 (83)	000D	Alarm 1 Type	H'00000000 (0): Alarm function OFF H'00000001 (1): Upper and lower limit alarm H'00000002 (2): Upper limit alarm H'00000003 (3): Lower limit alarm H'00000004 (4): Upper and lower limit range alarm H'00000005 (5): Upper and lower limit alarm with standby sequence H'00000006 (6): Upper limit alarm with standby sequence H'00000007 (7): Lower limit alarm with standby sequence H'00000008 (8): Absolute value upper limit alarm H'00000009 (9): Absolute value lower limit alarm H'0000000A (10): Absolute value upper limit alarm with standby sequence H'0000000B (11): Absolute value lower limit alarm with standby sequence H'0000000C (12): LBA (Loop Burnout Alarm) H'0000000D (13): PV change rate alarm H'0000000E (14): RSP absolute value upper limit alarm H'0000000F (15): RSP absolute value lower limit alarm	Initial setting
C3 (83)	000E	Alarm 2 Type	H'00000000 (0): Alarm function OFF H'00000001 (1): Upper and lower limit alarm H'00000002 (2): Upper limit alarm H'00000003 (3): Lower limit alarm H'00000004 (4): Upper and lower limit range alarm H'00000005 (5): Upper and lower limit alarm with standby sequence H'00000006 (6): Upper limit alarm with standby sequence H'00000007 (7): Lower limit alarm with standby sequence H'00000008 (8): Absolute value upper limit alarm H'00000009 (9): Absolute value lower limit alarm H'0000000A (10): Absolute value upper limit alarm with standby sequence H'0000000B (11): Absolute value lower limit alarm with standby sequence H'0000000C (12): No alarm function H'0000000D (13): PV change rate alarm H'0000000E (14): RSP absolute value upper limit alarm H'0000000F (15): RSP absolute value lower limit alarm	
C3 (83)	000F	Alarm 3 Type (See note 1.)	Same settings as the alarm 2 type	
C3 (83)	0010	Communications Unit No. (See note 2.)	H'00000000 to H'00000063 (0 to 99)	Communications setting
C3 (83)	0011	Communications Baud Rate (See note 2.)	H'00000000 (0): 1.2 H'00000001 (1): 2.4 H'00000002 (2): 4.8 H'00000003 (3): 9.6 H'00000004 (4): 19.2 H'00000005 (5): 38.4 H'00000006 (6): 57.6	
C3 (83)	0012	Communications Data Length (See note 2.)	H'00000007 (7): 7 H'00000008 (8): 8	
C3 (83)	0013	Communications Stop Bits (See note 2.)	H'00000001 (1): 1 H'00000002 (2): 2	
C3 (83)	0014	Communications Parity (See note 2.)	H'00000000 (0): None H'00000001 (1): Even H'00000002 (2): Odd	

Note: The alarm function can also be used in Controllers without alarm output terminals. In this case, confirm alarm occurrences via the status data.

Note 1: Not displayed on the Controller display when Alarm 3 is not assigned to the output.

Note 2: After communications parameters have been changed, reset the Controller to enable them.

SECTION 3 Communications Data for CompoWay/F

Com Data for CompoWay/F

Variable type	Address	Parameter name	Setting (monitor) value	Level
C3 (83)	0016	Event Input Assignment 1	H'00000000 (0): None H'00000001 (1): Run (OFF)/reset (ON) H'00000002 (2): Run (ON)/reset (OFF) H'00000003 (3): Auto/manual switch H'00000004 (4): Reset H'00000005 (5): Run H'00000006 (6): Hold/clear hold H'00000007 (7): Hold H'00000008 (8): Advance H'00000009 (9): Program No. switch 0 H'0000000A (10): Program No. switch 1 H'0000000B (11): Program No. switch 2 H'0000000C (12): Invert direct/reverse operation H'0000000D (13): Program SP mode/remote SP mode (See note 1.) H'0000000E (14): Remote SP mode/fixed SP mode (See note 1.) H'0000000F (15): Program SP mode/fixed SP mode H'00000010 (16): 100% AT execute/cancel H'00000011 (17): 40% AT execute/cancel H'00000012 (18): Setting change enable/disable H'00000013 (19): Communications writing enable/disable (See note 2.) H'00000014 (20): Latch cancel H'00000015 (21): Wait enable (ON)/disable (OFF)	Initial setting
C3 (83)	0017	Event Input Assignment 2	H'00000000 to H'00000015 (0 to 21) * Same as for Event Input Assignment 1.	
C3 (83)	0018	Event Input Assignment 3	H'00000000 to H'00000015 (0 to 21) * Same as for Event Input Assignment 1.	
C3 (83)	0019	Event Input Assignment 4	H'00000000 to H'00000015 (0 to 21) * Same as for Event Input Assignment 1.	
C3 (83)	001D	Standby Sequence Reset	H'00000000 (0): Condition A H'00000001 (1): Condition B	Advanced function setting
C3 (83)	001E	Auxiliary Output 1 Open in Alarm	H'00000000 (0): Close in alarm H'00000001 (1): Open in alarm	
C3 (83)	001F	Alarm 1 Hysteresis	Temperature: H'00000001 to H'00007E90 (0.1 to 3240.0) Analog: H'00000001 to H'0000270F (0.01 to 99.99)	Initial setting

Note 1: E5AN/EN-HT only.

Note 2: Only with external communications.

Variable type	Address	Parameter name	Setting (monitor) value	Level
C3 (83)	0020	Auxiliary Output 2 Open in Alarm	H'00000000 (0): Close in alarm H'00000001 (1): Open in alarm	Advanced function setting
C3 (83)	0021	Alarm 2 Hysteresis	Temperature: H'00000001 to H'00007E90 (0.1 to 3240.0) Analog: H'00000001 to H'0000270F (0.01 to 99.99)	Initial setting
C3 (83)	0022	Auxiliary Output 3 Open in Alarm (See note 1.)	H'00000000 (0): Close in alarm H'00000001 (1): Open in alarm	Advanced function setting
C3 (83)	0023	Alarm 3 Hysteresis (See note 1.)	Temperature: H'00000001 to H'00007E90 (0.1 to 3240.0) Analog: H'00000001 to H'0000270F (0.01 to 99.99)	Initial setting
C3 (83)	0024	HB ON/OFF	H'00000000 (0): OFF H'00000001 (1): ON	Advanced function setting
C3 (83)	0025	Heater Burnout Latch	H'00000000 (0): OFF H'00000001 (1): ON	
C3 (83)	0026	Heater Burnout Hysteresis	H'00000001 to H'000001F4 (0.1 to 50.0)	
C3 (83)	0028	$\alpha$	H'00000000 to H'00000064 (0.00 to 1.00)	
C3 (83)	002B	Input Digital Filter	H'00000000 to H'0000270F (0.0 to 999.9)	
C3 (83)	002C	Additional PV Display	H'00000000 (0): OFF H'00000001 (1): ON	
C3 (83)	002D	MV Display	H'00000000 (0): OFF (display of manipulated variable OFF) H'00000001 (1): ON (display of manipulated variable ON)	
C3 (83)	002E	Automatic Display Return Time	H'00000000 (0): OFF H'00000001 to H'00000063 (1 to 99)	
C3 (83)	002F	Alarm 1 Latch	H'00000000 (0): OFF H'00000001 (1): ON	
C3 (83)	0030	Alarm 2 Latch	H'00000000 (0): OFF H'00000001 (1): ON	
C3 (83)	0031	Alarm 3 Latch (See note 1.)	H'00000000 (0): OFF H'00000001 (1): ON	
C3 (83)	0032	Move to Protect Level Time	H'00000001 to H'0000001E (1 to 30)	
C3 (83)	0033	Input Error Output	H'00000000 (0): OFF H'00000001 (1): ON	
C3 (83)	0034	Cold Junction Compensation Method	H'00000000 (0): OFF H'00000001 (1): ON	

Note: The alarm function can also be used in Controllers without alarm output terminals. In this case, confirm alarm occurrences via the status data.

Note 1: Not displayed on the Controller display when Alarm 3 is not assigned to the output.

## SECTION 3 Communications Data for CompoWay/F

Variable type	Address	Parameter name	Setting (monitor) value	Level
C3 (83)	0036	PV Change Color	H'00000000 (0): Orange H'00000001 (1): Red H'00000002 (2): Green H'00000003 (3): Red to green: When ALM1 is ON H'00000004 (4): Green to red: When ALM1 is ON H'00000005 (5): Red to green to red: Within PV stable band: Green Outside stable band: Red H'00000006 (6): Green to orange to red: Within PV stable band: Orange Outside stable band: Green, red H'00000007 (7): Orange to green to red: Within PV stable band: Green Outside stable band: Orange, red H'00000008 (8): Red to orange to green: Linked to program. Rising: red, Constant: orange, Falling: green	Advanced function setting
C3 (83)	0037	PV Stable Band	Temperature: H'00000001 to H'00007E90 (0.1 to 3240.0) Analog: H'00000001 to H'0000270F (0.01 to 99.99)	
C3 (83)	0038	Alarm 1 ON Delay	H'00000000 to H'000003E7 (0 to 999)	
C3 (83)	0039	Alarm 2 ON Delay	H'00000000 to H'000003E7 (0 to 999)	
C3 (83)	003A	Alarm 3 ON Delay (See note 1.)	H'00000000 to H'000003E7 (0 to 999)	
C3 (83)	003B	Alarm 1 OFF Delay	H'00000000 to H'000003E7 (0 to 999)	
C3 (83)	003C	Alarm 2 OFF Delay	H'00000000 to H'000003E7 (0 to 999)	
C3 (83)	003D	Alarm 3 OFF Delay (See note 1.)	H'00000000 to H'000003E7 (0 to 999)	
C3 (83)	003E	Transfer Output Type	H'00000000 (0): OFF H'00000001 (1): Present SP H'00000002 (2): PV H'00000003 (3): MV (heating) H'00000004 (4): MV (cooling) H'00000005 (5): Valve opening	Initial setting
C3 (83)	003F	Transfer Output Upper Limit	H'FFFFFF831 to H'0000270F (-1999 to 9999) H'FFFFFFB1E1 to H'00007E90 (-19999 to 32400) (See note 2.)	
C3 (83)	0040	Transfer Output Lower Limit	H'FFFFFF831 to H'0000270F (-1999 to 9999) H'FFFFFFB1E1 to H'00007E90 (-19999 to 32400) (See note 2.)	
C3 (83)	0041	Linear Current Output	H'00000000 (0): 4 to 20 mA H'00000001 (1): 0 to 20 mA	
C3 (83)	0042	Input Shift Type	H'00000000 (0): Temperature input 1-point shift H'00000001 (1): Temperature input 2-point shift	Advanced function setting
C3 (83)	0043	MV at Reset and Error Addition	H'00000000 (0): OFF H'00000001 (1): ON	
C3 (83)	0044	Auto/Manual Select Addition	H'00000000 (0): OFF H'00000001 (1): ON	
C3 (83)	0045	RT	H'00000000 (0): OFF H'00000001 (1): ON	
C3 (83)	0046	HS Alarm Use	H'00000000 (0): OFF H'00000001 (1): ON	
C3 (83)	0047	HS Alarm Latch	H'00000000 (0): OFF H'00000001 (1): ON	
C3 (83)	0048	HS Alarm Hysteresis	H'00000001 to H'000001F4 (0.1 to 50.0)	
C3 (83)	0049	LBA Detection Time (See note 3.)	H'00000000 to H'0000270F (0 to 9999)	
C3 (83)	004A	LBA Level	Temperature: H'00000001 to H'00007E90 (0.1 to 3240.0) Analog: H'00000001 to H'0000270F (0.01 to 99.99)	
C3 (83)	004B	LBA Band	Temperature: H'00000000 to H'00007E90 (0.0 to 3240.0) Analog: H'00000000 to H'0000270F (0.00 to 99.99)	

Note 1: Not displayed on the Controller display when Alarm 3 is not assigned to the output.

Note 2: The setting (monitor) range depends on the transfer output type setting. (For details, refer to *SECTION 5 Parameter in E5CN/AN/EN-HT Digital Controllers Program Type User's Manual* (Cat. No. H169).)

Note 3: This parameter can be set only for ON/OFF control.

Variable type	Address	Parameter name	Setting (monitor) value	Level
C3 (83)	004C	Communications Protocol Setting (See note 1.)	H'00000000 (0): CompoWay/F H'00000001 (1): Modbus	Communi- cations set- ting
C3 (83)	004D	Send Data Wait Time (See note 1.)	H'00000000 to H'00000063 (0 to 99)	
C3 (83)	004E	Control Output 1 Assignment	When control output 1 is a linear output: H'00000000 (0): Not assigned. H'00000001 (1): Control output (heating) H'00000002 (2): Control output (cooling) When control output 1 is an ON/OFF output: H'00000000 (0): Not assigned. H'00000001 (1): Control output (heating) H'00000002 (2): Control output (cooling) H'00000003 (3): Alarm 1 H'00000004 (4): Alarm 2 H'00000005 (5): Alarm 3 H'00000006 (6): Program end output H'00000007 (7): Control output ON/OFF count alarm (See note 2.) H'00000008 (8): Stage output H'00000009 (9): Run output H'0000000A (10): Time signal 1 output H'0000000B (11): Time signal 2 output H'0000000C (12): Work bit 1 H'0000000D (13): Work bit 2 H'0000000E (14): Work bit 3 H'0000000F (15): Work bit 4 H'00000010 (16): Work bit 5 H'00000011 (17): Work bit 6 H'00000012 (18): Work bit 7 H'00000013 (19): Work bit 8	Advanced function setting
C3 (83)	004F	Control Output 2 Assignment	Same as for Control Output 1 Assignment.	

Note 1: After communications parameters have been changed, perform a software reset or turn the power OFF and ON again, to enable the changes.

Note 2: The output turns ON when the status of either the Control Output 1 ON/OFF Count Alarm or the Control Output 2 ON/OFF Count Alarm turns ON.

SECTION 3 Communications Data for CompoWay/F

Com Data for CompoWay/F

Variable type	Address	Parameter name	Setting (monitor) value	Level
C3 (83)	0050	Auxiliary Output 1 Assignment	H'00000000 (0): Not assigned. H'00000001 (1): Control output (heating) H'00000002 (2): Control output (cooling) H'00000003 (3): Alarm 1 H'00000004 (4): Alarm 2 H'00000005 (5): Alarm 3 H'00000006 (6): Program end output H'00000007 (7): Control output ON/OFF count alarm (See note 1.) H'00000008 (8): Stage output H'00000009 (9): Run output H'0000000A (10): Time signal 1 output H'0000000B (11): Time signal 2 output H'0000000C (12): Work bit 1 H'0000000D (13): Work bit 2 H'0000000E (14): Work bit 3 H'0000000F (15): Work bit 4 H'00000010 (16): Work bit 5 H'00000011 (17): Work bit 6 H'00000012 (18): Work bit 7 H'00000013 (19): Work bit 8	Advanced function setting
C3 (83)	0051	Auxiliary Output 2 Assignment	H'00000000 to H'00000013 (0 to 19) * Same as for the Auxiliary Output 1 Assignment parameter.	
C3 (83)	0052	Character Select	H'00000000 (0): OFF H'00000001 (1): ON	
C3 (83)	0055	Alarm SP Selection	H'00000000 (0): Present SP H'00000001 (1): Segment SP	Advanced function setting
C3 (83)	0056	Auxiliary Output 3 Assignment	H'00000000 to H'0000000F (0 to 15) * Same as for the Auxiliary Output 1 Assignment parameter.	Initial setting
C3 (83)	0057	Closed/Floating	H'00000000 (0): Floating H'00000001 (1): Closed	
C3 (83)	0058	Travel Time	H'00000001 to H'000003E7 (1 to 999)	Advanced function setting
C3 (83)	0059	PV Dead Band	H'00000000 to H'00007E90 (0 to 32400)	
C3 (83)	005B	Manual MV Limit Enable	H'00000000 (0): OFF H'00000001 (1): ON	
C3 (83)	005C	Direct Setting of Position Proportional MV	H'00000000 (0): OFF H'00000001 (1): ON	
C3 (83)	005D	AT Calculated Gain	H'00000001 to H'00000064 (0.1 to 10.0)	
C3 (83)	005E	AT Hysteresis	Temperature: H'00000001 to H'00007E90 (0.1 to 3240.0) Analog: H'00000001 to H'000003E7 (0.01 to 9.99)	
C3 (83)	005F	Limit Cycle MV Amplitude	H'00000032 to H'000001F4 (5.0 to 50.0)	
C3 (83)	0060	Remote SP Enable	H'00000000 (0): OFF H'00000001 (1): ON	
C3 (83)	0061	Remote SP Upper limit	SP lower limit to SP upper limit	
C3 (83)	0062	Remote SP Lower limit	SP lower limit to SP upper limit	
C3 (83)	0063	SP Tracking	H'00000000 (0): OFF H'00000001 (1): ON	
C3 (83)	0064	Remote SP Input Error Output	H'00000000 (0): OFF H'00000001 (1): ON	
C3 (83)	0065	PID Set Automatic Selection Data	H'00000000 (0): PV H'00000001 (1): DV H'00000002 (2): SP	

Note 1: The output turns ON when the status of either the Control Output 1 ON/OFF Count Alarm or the Control Output 2 ON/OFF Count Alarm turns ON.



Variable type	Address	Parameter name	Setting (monitor) value	Level
C3 (83)	0066	PID Set Automatic Selection Hysteresis	H'0000000A to H'0000270F (0.10 to 99.99)	Advanced function setting
C3 (83)	0067	PV Rate of Change Calculation Period	H'00000001 to H'000003E7 (1 to 999)	
C3 (83)	0068	Automatic Cooling Coefficient Adjustment	H'00000000 (0): OFF H'00000001 (1): ON	
C3 (83)	0069	Heater Overcurrent Use	H'00000000 (0): OFF H'00000001 (1): ON	
C3 (83)	006A	Heater Overcurrent Latch	H'00000000 (0): OFF H'00000001 (1): ON	
C3 (83)	006B	Heater Overcurrent Hysteresis	H'00000001 to H'000001F4 (0.1 to 50.0)	Initial setting
C3 (83)	006C	Extraction of Square Root Enable	H'00000000 (0): OFF H'00000001 (1): ON	Advanced function setting
C3 (83)	006D	PF Setting	H'00000000 (0): OFF H'00000001 (1): RUN H'00000002 (2): Reset H'00000003 (3): Run/reset H'00000004 (4): Hold/clear hold H'00000005 (5): Advance H'00000006 (6): 100% AT execute/cancel H'00000007 (7): 40% AT execute/cancel H'00000008 (8): Alarm latch cancel H'00000009 (9): Auto/manual H'0000000A (10): Monitor/setting item	
C3 (83)	006E	Monitor/Setting Item 1	H'00000000 (0): Disable H'00000001 (1): PV/SP/Program No. or segment No. H'00000002 (2): PV/SP/MV H'00000003 (3): PV/SP/Remaining segment time H'00000004 (4): Proportional band H'00000005 (5): Integral time H'00000006 (6): Derivative time H'00000007 (7): Alarm value 1 H'00000008 (8): Alarm value upper limit 1 H'00000009 (9): Alarm value lower limit 1 H'0000000A (10): Alarm value 2 H'0000000B (11): Alarm value upper limit 2 H'0000000C (12): Alarm value lower limit 2 H'0000000D (13): Alarm value 3 H'0000000E (14): Alarm value upper limit 3 H'0000000F (15): Alarm value lower limit 3 H'00000010 (16): Program No. H'00000011 (17): Segment No. H'00000012 (18): Elapsed program time H'00000013 (19): Remaining program time H'00000014 (20): Elapsed segment time H'00000015 (21): Remaining segment time	
C3 (83)	006F	Monitor/Setting Item 2	H'00000000 to H'00000015 (0 to 21) * Same as for Monitor/Setting Item 1.	
C3 (83)	0070	Monitor/Setting Item 3	H'00000000 to H'00000015 (0 to 21) * Same as for Monitor/Setting Item 1.	
C3 (83)	0071	Monitor/Setting Item 4	H'00000000 to H'00000015 (0 to 21) * Same as for Monitor/Setting Item 1.	
C3 (83)	0072	Monitor/Setting Item 5	H'00000000 to H'00000015 (0 to 21) * Same as for Monitor/Setting Item 1.	

**SECTION 3 Communications Data for CompoWay/F**

Variable type	Address	Parameter name	Setting (monitor) value	Level
C3 (83)	0073	PV/SP Display Screen Selection	H'00000000 (0): Only PV/SP displayed (no No. 3 display). H'00000001 (1): The PV/SP/Program No. or Segment No., and the PV/SP/MV are displayed in order. H'00000002 (2): The PV/SP/MV and PV/SP/Program No. or Segment No. are displayed in order. H'00000003 (3): Only the PV/SP/Program No. or Segment No. are displayed. H'00000004 (4): Only the PV/SP/MV are displayed. H'00000005 (5): The PV/SP/Program No. or Segment No., and the PV/SP/Remaining Segment Time are displayed in order. H'00000006 (6): The PV/SP/MV and PV/SP/Remaining Segment Time are displayed in order. H'00000007 (7): Only the PV/SP/Remaining Segment Time are displayed.	Advanced function setting
C3 (83)	0074	MV Display Selection	H'00000000 (0): MV (heating) H'00000001 (1): MV (cooling)	
C3 (83)	0075	PV Decimal Point Display	H'00000000 (0): OFF H'00000001 (1): ON	
C3 (83)	0076	PV Status Display Function	H'00000000 (0): OFF H'00000001 (1): Manual H'00000002 (2): Reset H'00000003 (3): Alarm 1 H'00000004 (4): Alarm 2 H'00000005 (5): Alarm 3 H'00000006 (6): Alarm 1 to 3 OR status H'00000007 (7): Heater alarm H'00000008 (8): Standby	
C3 (83)	0077	SV Status Display Function	H'00000000 to H'00000008 (0 to 8) * Same as for PV Status Display Function	
C3 (83)	0078	Control Output 1 ON/OFF Count Alarm Set Value	H'00000000 to H'0000270F (0 to 9999)	
C3 (83)	0079	Control Output 2 ON/OFF Count Alarm Set Value	H'00000000 to H'0000270F (0 to 9999)	
C3 (83)	0083	Display Refresh Period	H'00000000 (0): OFF H'00000001 (1): 0.25 H'00000002 (2): 0.5 H'00000003 (3): 1.0	Advanced function setting
C3 (83)	0084	Program Time Unit	H'00000000 (0): Hours, minutes H'00000001 (1): Minutes, seconds	Initial setting
C3 (83)	0085	Time Setting/Gradient Setting	H'00000000 (0): Time setting H'00000001 (1): Gradient setting	
C3 (83)	0086	Gradient Time Setting Unit	H'00000000 (0): Minutes H'00000001 (1): Hours	
C3 (83)	0087	Reset Operation	H'00000000 (0): Stop control H'00000001 (1): Fixed SP operation	
C3 (83)	0088	Startup Operation	H'00000000 (0): Continue control at final SP H'00000001 (1): Reset H'00000002 (2): Run H'00000003 (3): Manual (See note 1.)	
C3 (83)	0089	Operation End Operation	H'00000000 (0): Reset H'00000001 (1): Continue control at final SP H'00000002 (2): Fixed SP mode (See note 2.)	
C3 (83)	008A	PV Start	H'00000000 (0): SP-priority SP start H'00000001 (1): Slope-priority PV start	
C3 (83)	008B	Program End ON Time	H'00000000 to H'00000064 (0.0 to 10.0) H'FFFFFFF(ON)	Advanced function setting
C3 (83)	008C	Standby Time Unit	H'00000000 (0): Hours, minutes H'00000001 (1): Days, hours	
C3 (83)	008D	Program SP Shift Value Addition	H'00000000 (0): OFF H'00000001 (1): ON	
C3 (83)	008E	RSP Broken-line Correction Display Addition	H'00000000 (0): OFF H'00000001 (1): ON	

Note 1: Selection is not possible when ON/OFF control is set.

Note 2: Selection is not possible if the Reset Operation parameter is set to fixed SP operation.

Variable type	Address	Parameter name	Setting (monitor) value	Level
C4 (84)	0000	Program Selection	H'00000000 to H'00000007 (0 to 7)	Program setting
C4 (84)	0001	No. of Segments Used (See note 1.)	H'00000001 to H'00000020 (32)	
C4 (84)	0002	Segment Selection (See note 1.)	H'00000000 to H'0000001F (31)	
C4 (84)	0003	Segment Type (See note 2.)	H'00000000 (0): Ramp H'00000001 (1): Soak H'00000002 (2): Step	
C4 (84)	0004	Segment SP (See note 2.)	SP lower limit to SP upper limit	
C4 (84)	0005	Segment Slope (See note 2.)	H'00000000 to H'00007E90 (0 to 32400)	
C4 (84)	0006	Segment Time (See note 2.)	H'00000000 to H'00009959 (0.00 to 99.59) (hours, minutes) H'00000000 to H'00009959 (0.00 to 99.59) (minutes, seconds)	
C4 (84)	0007	PID Set No. (See note 1.)	H'00000000 to H'00000008 (0 to 8) (0): Automatic Selection	
C4 (84)	0008	Alarm Value 1	H'FFFFB1E1 to H'00007E90 (-19999 to 32400)	
C4 (84)	0009	Alarm Upper Limit 1 (See note 1.)	H'FFFFB1E1 to H'00007E90 (-19999 to 32400)	
C4 (84)	000A	Alarm Lower Limit 1 (See note 1.)	H'FFFFB1E1 to H'00007E90 (-19999 to 32400)	
C4 (84)	000B	Alarm Value 2 (See note 1.)	H'FFFFB1E1 to H'00007E90 (-19999 to 32400)	
C4 (84)	000C	Alarm Upper Limit 2 (See note 1.)	H'FFFFB1E1 to H'00007E90 (-19999 to 32400)	
C4 (84)	000D	Alarm Lower Limit 2 (See note 1.)	H'FFFFB1E1 to H'00007E90 (-19999 to 32400)	
C4 (84)	000E	Alarm Value 3 (See note 1.)	H'FFFFB1E1 to H'00007E90 (-19999 to 32400)	
C4 (84)	000F	Alarm Upper Limit 3 (See note 1.)	H'FFFFB1E1 to H'00007E90 (-19999 to 32400)	
C4 (84)	0010	Alarm Lower Limit 3 (See note 1.)	H'FFFFB1E1 to H'00007E90 (-19999 to 32400)	
C4 (84)	0011	Program Repetitions (See note 1.)	'00000000 to '0000270F (0 to 9999)	
C4 (84)	0012	Program Link Destination No. (See note 1.)	H'FFFFFFF(-1): No link H'00000000 to H'00000007 (0 to 7)	
C4 (84)	0013	Time Signal 1 Set Segment (See note 1.)	H'00000000 (0) to No. of segments used -1	
C4 (84)	0014	Time Signal 1 ON Time (See note 1.)	H'00000000 to H'00009959 (0.00 to 99.59) (hours, minutes) H'00000000 to H'00009959 (0.00 to 99.59) (minutes, seconds)	
C4 (84)	0015	Time Signal 1 OFF Time (See note 1.)	H'00000000 to H'00009959 (0.00 to 99.59) (hours, minutes) H'00000000 to H'00009959 (0.00 to 99.59) (minutes, seconds)	
C4 (84)	0016	Time Signal 2 Set Segment (See note 1.)	H'00000000 (0) to No. of segments used -1	
C4 (84)	0017	Time Signal 2 ON Time (See note 1.)	H'00000000 to H'00009959 (0.00 to 99.59) (hours, minutes) H'00000000 to H'00009959 (0.00 to 99.59) (minutes, seconds)	
C4 (84)	0018	Time Signal 2 OFF Time (See note 1.)	H'00000000 to H'00009959 (0.00 to 99.59) (hours, minutes) H'00000000 to H'00009959 (0.00 to 99.59) (minutes, seconds)	

Note 1: The set values for the program specified in the Program Selection parameter are accessed for the following parameters: No. of Segments Used, Segment Selection, PID Set No., Alarm Values 1 to 3, Alarm Upper Limits 1 to 3, Alarm Lower Limits 1 to 3, Program Repetitions, Program Link Destination No., Time Signal 1 and 2 Set Segments, Time Signal 1 and 2 ON Times, and Time Signal 1 and 2 OFF Times. Check the set value of the Program Selection parameter before accessing these parameters.

Note 2: The set values for the program specified in the Program Selection parameter and the section specified in the Segment Selection parameter are accessed for the following parameters: Segment Type, Segment SP, Segment Slope, and Segment Time. Check the set values of the Program Selection parameter and the Segment Selection parameter before accessing these parameters.

SECTION 3 Communications Data for CompoWay/F

Com Data for CompoWay/F

Variable type	Address	Parameter name	Setting (monitor) value	Level
C5 (85)	0000	PID 1 Proportional Band	Temperature: H'00000001 to H'00007E90 (0.1 to 3240.0) Analog: H'00000001 to H'0000270F (0.1 to 999.9)	PID setting
C5 (85)	0001	PID 1 Integral Time	Standard, heating/cooling, position proportional (closed): H'00000000 to H'00007E90 (0.0 to 3240.0) Position proportional (floating): H'00000001 to H'00007E90 (0.1 to 3240.0)	
C5 (85)	0002	PID 1 Derivative Time	H'00000000 to H'00007E90 (0.0 to 3240.0)	
C5 (85)	0003	PID 1 MV Upper Limit	Standard: MV lower limit + 0.1 to H'0000041A (MV lower limit + 0.1 to 105.0) Heating/cooling: H'00000000 to H'0000041A (0.0 to 105.0) Position proportional (closed): MV lower limit +0.1 to H'0000041A (MV lower limit + 0.1 to 105.0)	
C5 (85)	0004	PID 1 MV Lower Limit	Standard: H'FFFFFFCE to MV upper limit -0.1 (-5.0 to MV upper limit -0.1) Heating/cooling: H'FFFFFFB6 to H'00000000 (-105.0 to 0.0) Position proportional (closed): H'FFFFFFCE to MV upper limit -0.1 (-5.0 to MV upper limit -0.1)	
C5 (85)	0005	PID 1 Automatic Selection Range Upper Limit	Temperature: H'FFFFFFB1E1 to H'00007E90 (-19999 to 32400) Analog: H'FFFFFFCE to H'0000041A (-5.0 to 105.0)	
C5 (85)	0006	PID 1 Cooling Coefficient	H'00000001 to H'0000270F (0.01 to 99.99)	
C5 (85)	0007	PID 1 LBA Detection Time	H'00000000 to H'0000270F (0 to 9999)	
C5 (85)	0010	PID 2 Proportional Band	Temperature: H'00000001 to H'00007E90 (0.1 to 3240.0) Analog: H'00000001 to H'0000270F (0.1 to 999.9)	
		to		
C5 (85)	0017	PID2 LBA Detection Time	H'00000000 to H'0000270F (0 to 9999)	
C5 (85)	0020	PID3 Proportional Band	Temperature: H'00000001 to H'00007E90 (0.1 to 3240.0) Analog: H'00000001 to H'0000270F (0.1 to 999.9)	
		to		
C5 (85)	0027	PID3 LBA Detection Time	H'00000000 to H'0000270F (0 to 9999)	
C5 (85)	0030	PID4 Proportional Band	Temperature: H'00000001 to H'00007E90 (0.1 to 3240.0) Analog: H'00000001 to H'0000270F (0.1 to 999.9)	
		to		
C5 (85)	0037	PID4 LBA Detection Time	H'00000000 to H'0000270F (0 to 9999)	
C5 (85)	0040	PID5 Proportional Band	Temperature: H'00000001 to H'00007E90 (0.1 to 3240.0) Analog: H'00000001 to H'0000270F (0.1 to 999.9)	
		to		
C5 (85)	0047	PID5 LBA Detection Time	H'00000000 to H'0000270F (0 to 9999)	
C5 (85)	0050	PID6 Proportional Band	Temperature: H'00000001 to H'00007E90 (0.1 to 3240.0) Analog: H'00000001 to H'0000270F (0.1 to 999.9)	
		to		
C5 (85)	0057	PID6 LBA Detection Time	H'00000000 to H'0000270F (0 to 9999)	
C5 (85)	0060	PID7 Proportional Band	Temperature: H'00000001 to H'00007E90 (0.1 to 3240.0) Analog: H'00000001 to H'0000270F (0.1 to 999.9)	
		to		
C5 (85)	0067	PID7 LBA Detection Time	H'00000000 to H'0000270F (0 to 9999)	
C5 (85)	0070	PID8 Proportional Band	Temperature: H'00000001 to H'00007E90 (0.1 to 3240.0) Analog: H'00000001 to H'0000270F (0.1 to 999.9)	
		to		
C5 (85)	0077	PID8 LBA Detection Time	H'00000000 to H'0000270F (0 to 9999)	

Variable type	Address	Parameter name	Setting (monitor) value	Level
DA (9A)	0000	Program 0 No. of Segments Used	H'00000001 to H'00000020 (1 to 32)	Program setting
DA (9A)	0001	Program 0 PID Set No.	H'00000000 to H'00000008 (0 to 8) (0): Automatic Selection	
DA (9A)	0002	Program 0 Alarm Value 1	H'FFFFB1E1 to H'00007E90 (-19999 to 32400)	
DA (9A)	0003	Program 0 Alarm Upper Limit 1	H'FFFFB1E1 to H'00007E90 (-19999 to 32400)	
DA (9A)	0004	Program 0 Alarm Lower Limit 1	H'FFFFB1E1 to H'00007E90 (-19999 to 32400)	
DA (9A)	0005	Program 0 Alarm Value 2	H'FFFFB1E1 to H'00007E90 (-19999 to 32400)	
DA (9A)	0006	Program 0 Alarm Upper Limit 2	H'FFFFB1E1 to H'00007E90 (-19999 to 32400)	
DA (9A)	0007	Program 0 Alarm Lower Limit 2	H'FFFFB1E1 to H'00007E90 (-19999 to 32400)	
DA (9A)	0008	Program 0 Alarm Value 3	H'FFFFB1E1 to H'00007E90 (-19999 to 32400)	
DA (9A)	0009	Program 0 Alarm Upper Limit 3	H'FFFFB1E1 to H'00007E90 (-19999 to 32400)	
DA (9A)	000A	Program 0 Alarm Lower Limit 3	H'FFFFB1E1 to H'00007E90 (-19999 to 32400)	
DA (9A)	000B	Program 0 Program Repetitions	H'00000000 to H'0000270F (0 to 9999)	
DA (9A)	000C	Program 0 Program Link Destination No.	H'FFFFFFF(-1): No link H'00000000 to H'00000007 (0 to 7)	
DA (9A)	000D	Program 0 Time Signal 1 Set Segment	H'00000000 (0) to No. of segments used -1	
DA (9A)	000E	Program 0 Time Signal 1 ON Time	H'00000000 to H'00009959 (0.00 to 99.59) (hours, minutes) H'00000000 to H'00009959 (0.00 to 99.59) (minutes, seconds)	
DA (9A)	000F	Program 0 Time Signal 1 OFF Time	H'00000000 to H'00009959 (0.00 to 99.59) (hours, minutes) H'00000000 to H'00009959 (0.00 to 99.59) (minutes, seconds)	
DA (9A)	0010	Program 0 Time Signal 2 Set Segment	H'00000000 (0) to No. of segments used -1	
DA (9A)	0011	Program 0 Time Signal 2 ON Time	H'00000000 to H'00009959 (0.00 to 99.59) (hours, minutes) H'00000000 to H'00009959 (0.00 to 99.59) (minutes, seconds)	
DA (9A)	0012	Program 0 Time Signal 2 OFF Time	H'00000000 to H'00009959 (0.00 to 99.59) (hours, minutes) H'00000000 to H'00009959 (0.00 to 99.59) (minutes, seconds)	
DA (9A)	0013	Program 0 Segment 0 Type	H'00000000 (0): Ramp H'00000001 (1): Soak H'00000002 (2): Step	
DA (9A)	0014	Program 0 Segment 0 SP	SP lower limit to SP upper limit	
DA (9A)	0015	Program 0 Segment 0 Slope	H'00000000 to H'00007E90 (0 to 32400)	
DA (9A)	0016	Program 0 Segment 0 Time	H'00000000 to H'00009959 (0.00 to 99.59) (hours, minutes) H'00000000 to H'00009959 (0.00 to 99.59) (minutes, seconds)	
DA (9A)	0017	Program 0 Segment 1 Type	Same as for segment 0.	
DA (9A)		to		
DA (9A)	001B	Program 0 Segment 2 Type		
DA (9A)		to		
DA (9A)	001F	Program 0 Segment 3 Type		
DA (9A)		to		
DA (9A)	0023	Program 0 Segment 4 Type		
DA (9A)		to		
DA (9A)	0027	Program 0 Segment 5 Type		
DA (9A)		to		
DA (9A)	002B	Program 0 Segment 6 Type		
DA (9A)		to		
DA (9A)	002F	Program 0 Segment 7 Type		
DA (9A)		to		
DA (9A)	0033	Program 0 Segment 8 Type		
DA (9A)		to		
DA (9A)	0037	Program 0 Segment 9 Type		
DA (9A)		to		
DA (9A)	003B	Program 0 Segment 10 Type		
DA (9A)		to		
DA (9A)	003F	Program 0 Segment 11 Type		
DA (9A)		to		

SECTION 3 Communications Data for CompoWay/F

Com Data for CompoWay/F

Variable type	Address	Parameter name	Setting (monitor) value	Level
DA (9A)	0043	Program 0 Segment 12 Type		
DA (9A)		to		
DA (9A)	0047	Program 0 Segment 13 Type		
DA (9A)		to		
DA (9A)	004B	Program 0 Segment 14 Type		
DA (9A)		to		
DA (9A)	004F	Program 0 Segment 15 Type		
DA (9A)		to		
DA (9A)	0053	Program 0 Segment 16 Type		
DA (9A)		to		
DA (9A)	0057	Program 0 Segment 17 Type		
DA (9A)		to		
DA (9A)	005B	Program 0 Segment 18 Type		
DA (9A)		to		
DA (9A)	005F	Program 0 Segment 19 Type		
DA (9A)		to		
DA (9A)	0063	Program 0 Segment 20 Type		
DA (9A)		to		
DA (9A)	0067	Program 0 Segment 21 Type		
DA (9A)		to		
DA (9A)	006B	Program 0 Segment 22 Type		
DA (9A)		to		
DA (9A)	006F	Program 0 Segment 23 Type		
DA (9A)		to		
DA (9A)	0073	Program 0 Segment 24 Type		
DA (9A)		to		
DA (9A)	0077	Program 0 Segment 25 Type		
DA (9A)		to		
DA (9A)	007B	Program 0 Segment 26 Type		
DA (9A)		to		
DA (9A)	007F	Program 0 Segment 27 Type		
DA (9A)		to		
DA (9A)	0083	Program 0 Segment 28 Type		
DA (9A)		to		
DA (9A)	0087	Program 0 Segment 29 Type		
DA (9A)		to		
DA (9A)	008B	Program 0 Segment 30 Type		
DA (9A)		to		
DA (9A)	008F	Program 0 Segment 31 Type		
DA (9A)		to		
DA (9A)	0100	Program 1 No. of Segments Used	Same as for program 0.	
DA (9A)		to		
DA (9A)	0200	Program 2 No. of Segments Used		
DA (9A)		to		
DA (9A)	0300	Program 3 No. of Segments Used		
DA (9A)		to		
DA (9A)	0400	Program 4 No. of Segments Used		
DA (9A)		to		
DA (9A)	0500	Program 5 No. of Segments Used		
DA (9A)		to		

Variable type	Address	Parameter name	Setting (monitor) value	Level
DA (9A)	0600	Program 6 No. of Segments Used		
DA (9A)		to		
DA (9A)	0700	Program 7 No. of Segments Used		
DA (9A)		to		

## 3.2 Status and Status 2

The figure below shows the structure of the status data.

### ■ Status Structure

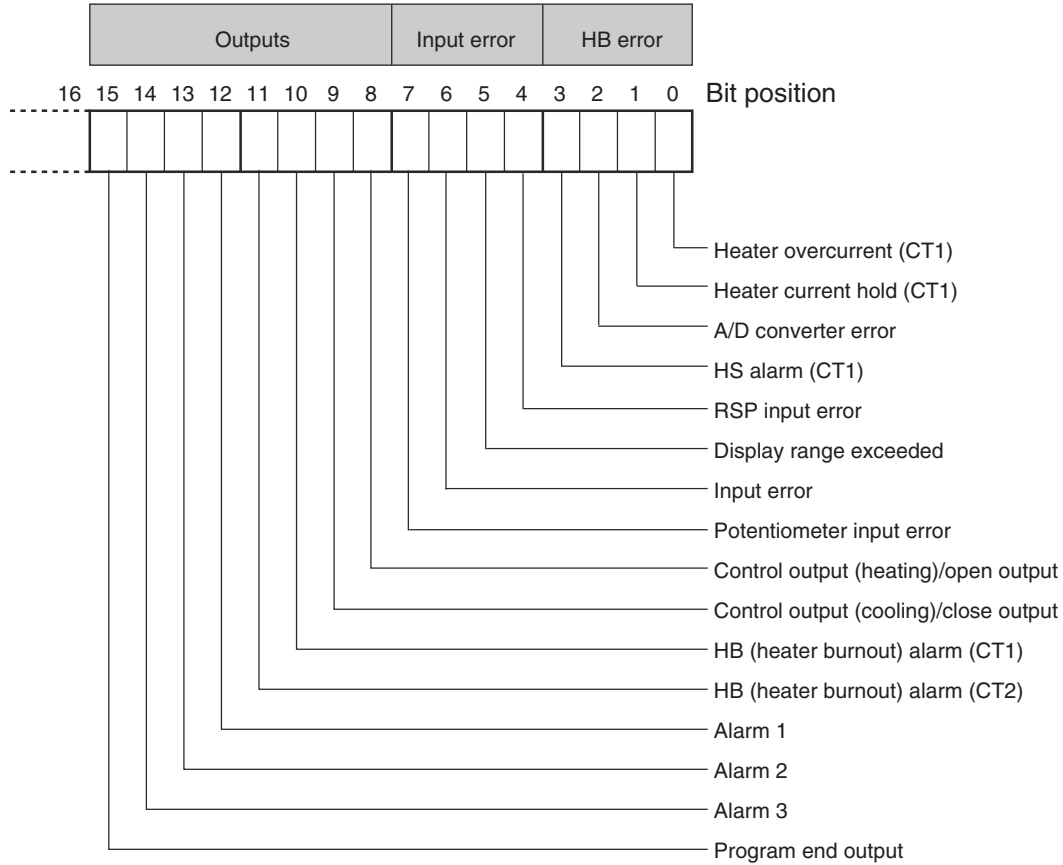



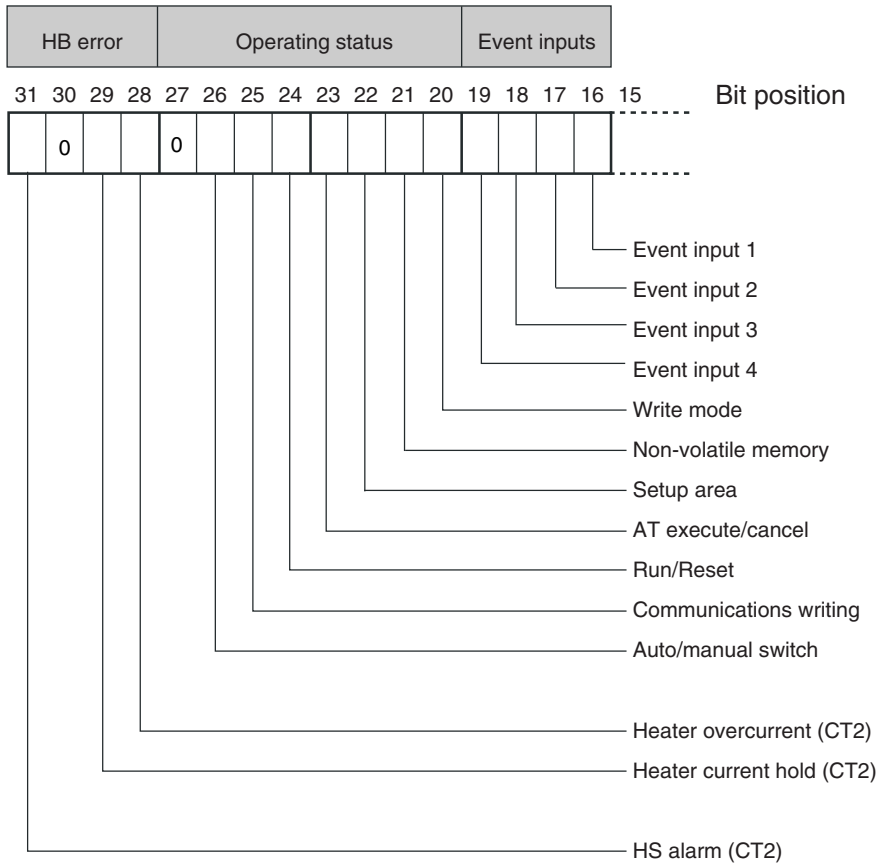

### ■ Status 2 Structure

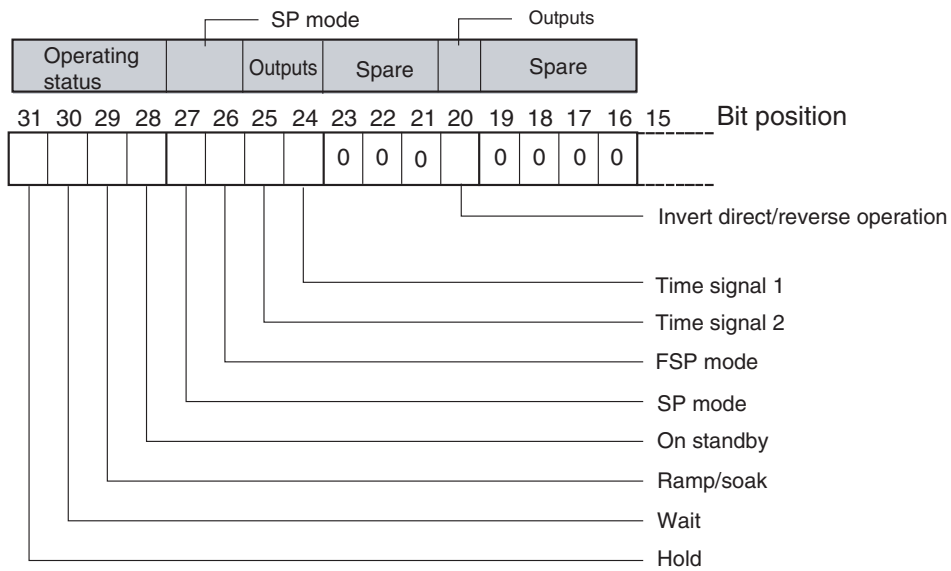
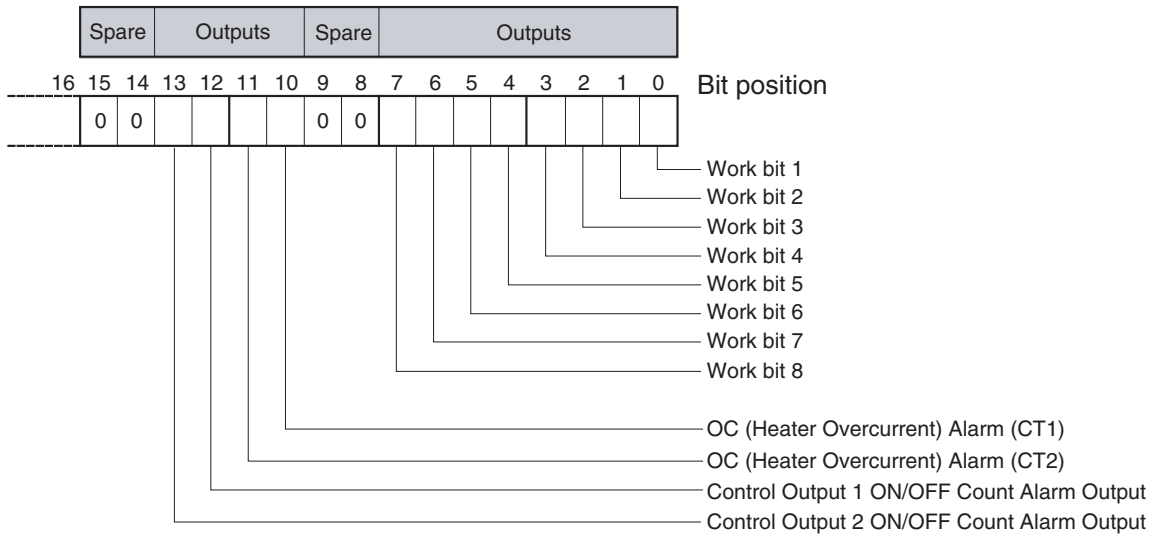

Com Data for CompoWay/F

## ■ Status Details

Bit position	Status	Bit Description		
		0	1	
Status (lower word)	0	Heater overcurrent (CT1)	Not generated	Generated
	1	Heater current hold (CT1) (See note 1.)	Update	Hold
	2	A/D converter error	Not generated	Generated
	3	HS alarm (CT1)	OFF	ON
	4	RSP input error	Not generated	Generated
	5	Display range exceeded	Not generated	Generated
	6	Input error	Not generated	Generated
	7	Potentiometer input error	Not generated	Generated
	8	Control output (heating)/open output	OFF	ON
	9	Control output (cooling)/close output	OFF	ON
	10	HB (heater burnout) alarm (CT1)	OFF	ON
	11	HB (heater burnout) alarm (CT2)	OFF	ON
	12	Alarm 1	OFF	ON
	13	Alarm 2	OFF	ON
	14	Alarm 3	OFF	ON
15	Program end output	OFF	ON	
Status (upper word)	16	Event input 1	OFF	ON
	17	Event input 2	OFF	ON
	18	Event input 3	OFF	ON
	19	Event input 4	OFF	ON
	20	Write mode	Backup mode	RAM write mode
	21	Non-volatile memory	RAM = Non-volatile memory	RAM ≠ Non-volatile memory
	22	Setup area	Setup area 0	Setup area 1
	23	AT execute/cancel	AT canceled	AT execution in progress
	24	Run/Reset	Run	Reset
	25	Communications writing	OFF (disabled)	ON (enabled)
	26	Auto/manual switch	Automatic mode	Manual mode
	27	Spare	OFF	---
	28	Heater overcurrent (CT2)	Not generated	Generated
	29	Heater current hold (CT2) (See note 1.)	Update	Hold
	30	Spare	OFF	---
	31	HS alarm (CT2)	OFF	ON

Note 1: When the control output ON time is less than 100 ms, the bit is set to “1” and the heater current is held at the last current value.

Note 2: “Spare” bits are always OFF.

Note 3: When read in setup area 1, the status of the bits will be as follows:

- Overcurrent: Last value held
- A/D converter error: Last value held
- Input error: Last value held
- Potentiometer input error: Last value held
- HB and HS outputs: Cleared
- Program end output: Cleared
- Current hold: Last value held
- Display range exceeded: Last value held
- RSP input error: Last value held
- Heating output, cooling output, open output, close output: Cleared
- Alarm outputs: Cleared

## ■ Status 2 Details

Bit position		Status	Bit Description	
			0	1
Status (lower word)	0	Work bit 1	OFF	ON
	1	Work bit 2	OFF	ON
	2	Work bit 3	OFF	ON
	3	Work bit 4	OFF	ON
	4	Work bit 5	OFF	ON
	5	Work bit 6	OFF	ON
	6	Work bit 7	OFF	ON
	7	Work bit 8	OFF	ON
	8	Spare	OFF	---
	9	Spare	OFF	---
	10	OC (Heater Overcurrent) Alarm (CT1)	OFF	ON
	11	OC (Heater Overcurrent) Alarm (CT2)	OFF	ON
	12	Control Output 1 ON/OFF Count Alarm Output	OFF	ON
	13	Control Output 2 ON/OFF Count Alarm Output	OFF	ON
	14	Spare	OFF	
15	Spare	OFF	---	
Status (upper word)	16	Spare	OFF	---
	17	Spare	OFF	---
	18	Spare	OFF	---
	19	Spare	OFF	---
	20	Invert direct/reverse operation	Not Invert	Invert
	21	Spare	OFF	---
	22	Spare	OFF	---
	23	Spare	OFF	---
	24	Time signal 1	OFF	ON
	25	Time signal 2	OFF	ON
	26	FSP mode (See note 1.)	OFF (PSP/RSP)	ON (FSP)
	27	SP mode (See note 1.)	PSP	RSP
	28	On standby	OFF	On standby
	29	Ramp/soak	Soak	Ramp
	30	Wait	OFF	Waiting
	31	Hold	OFF	Holding

Note 1: Bit 27 (SP mode) is enabled when bit 26 (FSP mode) is 1 (ON: FSP).

Note 2: "Spare" bits are always OFF.

Note 3: When read in setup area 1, the status of the bits will be as follows:

- Overcurrent Output: Cleared
- Control Output 1 ON/OFF Count Alarm: Cleared
- Control Output 2 ON/OFF Count Alarm: Cleared
- Work bits 1 to 8: Cleared
- Time signal 1 to 2: Last value held
- FSP mode: Last value held
- SP mode: Last value held
- On standby: Last value held
- Ramp/soak: Last value held
- Wait: Last value held
- Hold: Last value held

# SECTION 4

## Modbus Communications Procedure

Read this section if you are to communicate using the Modbus format.

4.1	Data Format.....	4-2
	Command Frame.....	4-2
	CRC-16 Calculation Example.....	4-3
	Response Frame.....	4-4
	Normal Response Frame.....	4-4
	Error Response Frame.....	4-4
	Error Codes.....	4-5
	No Response.....	4-5
4.2	Function List.....	4-6
4.3	Variable Area.....	4-7
	Addresses.....	4-7
	Number of Elements.....	4-8
	Set Values.....	4-8
4.4	Detailed Description of the Services.....	4-9
	Variable Read, Multiple.....	4-9
	Variable Write, Multiple.....	4-11
	Variable Write, Single/Operation Command.....	4-14
	Echoback Test.....	4-21

## 4.1 Data Format

The data format complies with the Modbus (RTU) communications protocol, so commands from the host and responses from the E5CN/AN/EN-HT are contained in data blocks called frames.

The structure of the command and response frames is described below.

In the following explanations, hexadecimal values are expressed by adding the prefix H' before the number, e.g., H'02. Numbers and alphabetic characters without the H' prefix are ASCII characters.

### ■ Command Frame

When using RTU mode, start with a silent interval of at least 3.5 character times and end with a silent interval of at least 3.5 character times.

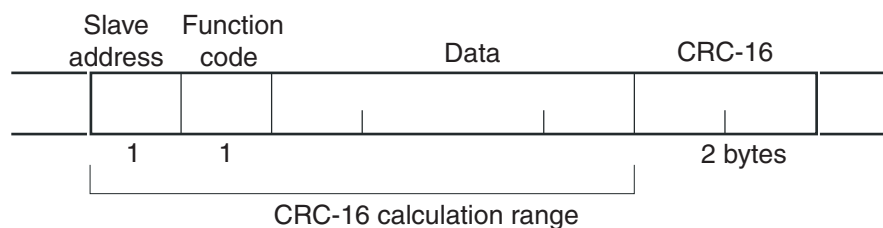

	Silent interval of 3.5 character times minimum.
<b>Slave address</b>	Specify the unit number. The unit number can be set between H'00 to H'63 hexadecimal (0 to 99 decimal). Specify H'00 for a broadcast transmission. No responses will be returned for broadcast transmissions.
<b>Function code</b>	The function code is a 1-byte hexadecimal code that indicates the type of command sent from the host device.
<b>Data</b>	This is the text data associated with the specified function code. Specify the required data, such as the variable address or setting data. (Set in hexadecimal.)
<b>CRC-16</b>	Cyclical Redundancy Check This check code is calculated with the data from the slave address to the end of the data. The check code is 2-byte hexadecimal.
	Silent interval of 3.5 character times minimum.

## ● CRC-16 Calculation Example

Messages are processed one byte at a time in the work memory (a 16-bit register known as the CRC register).

- (1) The CRC register is initialized to H'FFFF.
- (2) An XOR operation is performed on the content of the CRC register and the first byte of the message, and the result is returned to the CRC register.
- (3) The MSB is packed with zeroes and the CRC register is shifted 1 bit to the right.
- (4) If the bit shifted from the LSB is 0, step 3 is repeated (next bit-shift processing).  
If the bit shifted from the LSB is 1, an XOR is performed on the content of the CRC register and H'A001, and the result is returned to the CRC register.
- (5) Steps 3 and 4 are repeated until 8 bits are shifted.
- (6) CRC processing continues to the end of the message, as XOR operations are performed on the content of the CRC register and the next byte of the message, step 3 is repeated, and the result is returned to the CRC register.
- (7) The result of the CRC calculation (value in the CRC register) is appended to the last byte of the message.

### Example of Appending the Calculation Result

When the calculated CRC value is H'1234, the CRC value is appended to the command frame as follows.

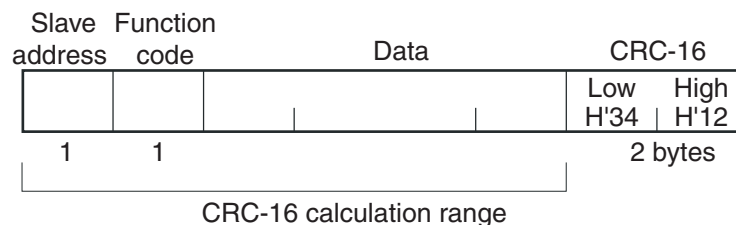

## ■ Response Frame

### ● Normal Response Frame

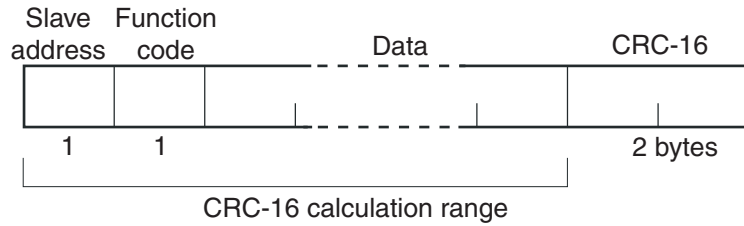

### ● Error Response Frame

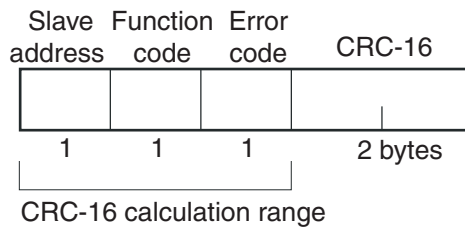

<b>Slave address</b>	The number specified in the command frame is entered as-is. This is the unit number of the Unit returning the response.
<b>Function code</b>	This is the received function code with the hexadecimal value of H'80 added to indicate that the response is an error response. Example: Received function code = H'03 Function code in response frame when an error occurred = H'83
<b>Error code</b>	This code indicates the kind of error that occurred.
<b>CRC-16</b>	Cyclical Redundancy Check This check code is calculated with the data from the slave address to the end of the data. The check code is 2-byte hexadecimal.



## ■ Error Codes

End code	Name	Description	Error detection priority
H'01	Function code error	An unsupported function code was received.	1
H'02	Variable address error	The specified variable area address is out-of-range.	2
H'03	Variable data error	The amount of data does not match the number of elements. The byte count is not 2 times the number of elements. The response length exceeds the size of the communications buffer. The command code or related information in the operation command is wrong or the write data is not in the setting range.	3
H'04	Operation error	The write data contents are not allowed in the present operation mode. <ul style="list-style-type: none"> <li>◆ The Communications Writing parameter is set to "OFF" (disabled).</li> <li>◆ Attempted to write to a parameter in setup area 1 from setup area 0.</li> <li>◆ Attempted to write to a protect parameter from other than the protect level.</li> <li>◆ AT execution in progress</li> <li>◆ The command cannot be processed.</li> </ul>	4

## ● No Response

In the following cases, the received command will not be processed and a response will not be returned.

Consequently, a timeout error will occur at the host device.

- The slave address in the received command does not match the communications unit number.
- A parity error, framing error, or overrun error occurred due to a problem such as a transfer error.
- A CRC-16 code error occurred in the received command frame.
- There was a time interval of more than 3.5 character times between data packets that make up the command frame.

Furthermore, the specified function's processing will be performed but no response will be returned for broadcast functions (slave address = H'00).

## 4.2 Function List

The following table lists the function codes.

Function Code List

Function code	Name	Process
03 (H'03)	Read variable (multiple)	This function reads from the variable area. It is possible to read two or more consecutive variables.
16 (H'10)	Write variable (multiple)	This function writes to the variable area. It is possible to write two or more consecutive variables. It is also possible to broadcast this function (broadcast transmission).
06 (H'06)	Write variable (Single/operation command)	This function writes to the variable area and writes operation commands. It is also possible to write to a single parameter by specifying the address in 2-byte mode. (This is not supported in 4-byte mode.) It is also possible to broadcast this function (broadcast transmission.)
08 (H'08)	Echoback Test	This function performs an echoback test.

## 4.3 Variable Area

The variable area is the region of memory used to exchange data with the E5CN/AN/EN-HT through communications.

Operations such as reading the process value and reading/writing parameters are performed on the variable area.

On the other hand, operation commands do not use the variable area.

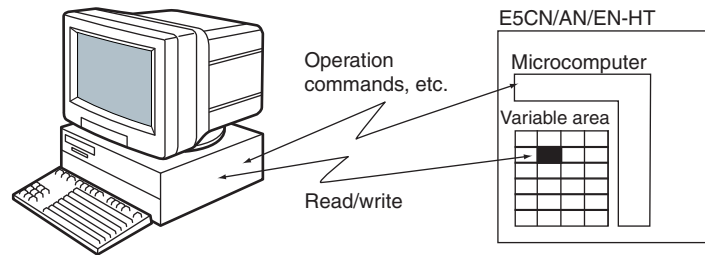

When accessing the variable area, the position of a variable in the variable area is specified with a word identifier, area number, and address in the area.

### ● Addresses

An address is appended to each of the variable types. Express addresses in 2-byte hexadecimal and append them for the specified access size. Each address is composed of a word identifier, area number, and address in the area.

#### • Four-byte Mode

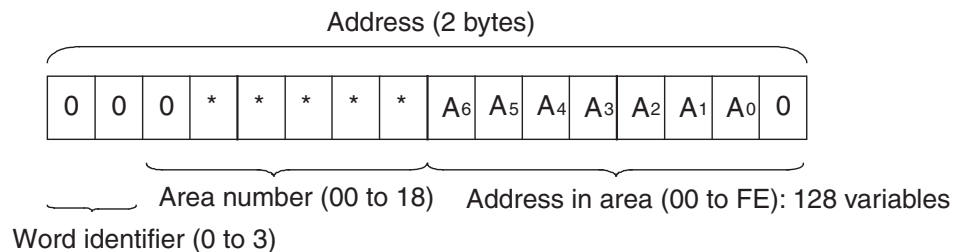

#### • Two-byte Mode

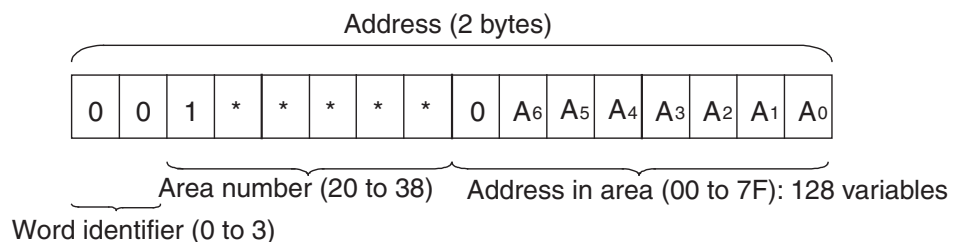

#### ◆ Modbus Addresses Corresponding to CompoWay/F Setup Areas 0 and 1

Setup area 0 and setup area 1 do not correspond directly to Modbus addresses, but the following areas have a rough correspondence with one exception.

\* Partial Exception to Modbus Address Correspondence

Setup area	Modbus addresses	
	Area number	Address range
Setup area 0	00 to 0B, 20 to 2B, 15, 18, 35, and 38	0000 to 0BFE, 2000 to 2B7F, 1500 to 15FE, 1800 to 1830, 3500 to 357F, and 3800 to 3818
Setup area 1	0C to 13 and 2C to 33	0C00 to 136C and 2C00 to 3336

The Hysteresis (Heating), Hysteresis (Cooling), Control Period (Heating), and Control Period (Cooling) parameters are assigned to consecutive addresses, but the control period parameters are setup area 1 parameters. For this reason, an operation error will occur when writing the control period (heating or cooling) from the setup area 0 side, e.g., from the operation level.

### ● Number of Elements

The number of elements is expressed in 2-byte hexadecimal. The setting range for the number of elements varies according to the command.

For example, when the number of elements is "0010," this specifies eight items of data (H'10) from the address.

- **Four-byte Mode**

One element uses 2 bytes of data, so specify two-element units. Reading and writing in 4-byte units is executed by specifying an even address and specifying the number of elements in multiples of 2.

- **Two-byte Mode**

One element uses 2 bytes of data, so specify one-element units. Reading and writing in 2-byte data units is executed by specifying 1-element units.

### ● Set Values

The values read from the variable area or written to the variable area are expressed in hexadecimal, ignoring the decimal point position. (Negative values are expressed in 2's complement format.)

Example: D'105.0 → H'0000041A

The variables are 4-digit or 8-digit hexadecimal values. Negative values are expressed in 2's complement format. The values are hexadecimal values with no decimal point indication.

For example, if the E5CN/AN/EN-HT's process value is read in 4-byte mode when the process value is 105.0, the read value will be H'0000041A (105.0 → 1050 → H'0000041A).

However, when reading or writing time data in hh.mm, mm.ss, or dd.hh, BCD data is used (the same format as the display).

Example: The data is H'00009959 for a display of 99.59.

## 4.4 Detailed Description of the Services

### Variable Read, Multiple

To read from the variable area, set the required data in the command frame, as shown in the following diagram.

Command Frame

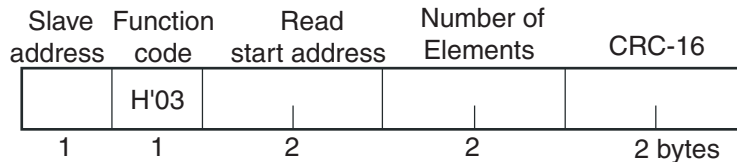

Name	Description
Slave address	Specify the E5CN/AN/EN-HT's unit number. The unit number can be set between H'01 and H'63 hexadecimal (1 to 99 decimal).
Function code	The Read Variable Area function's function code is H'03.
Read start address	Specify the address containing the data to be read. See <i>SECTION 5 Communications Data for Modbus</i> for details on addresses.
Number of elements	<p>Four-byte Mode</p> <p>Specify 2 times the number of setting data items as the number of elements to be read. The setting range for the number of elements is H'0002 to H'006A (2 to 106). When H'006A is set, 53 items of setting data can be read. Example: When reading 2 items of setting data, set the number of elements to H'0004.</p>
	<p>Two-byte Mode</p> <p>Specify the number of setting data items to be read as the number of elements. The setting range for the number of elements is H'0001 to H'006A (1 to 106). When H'006A is set, 106 items of setting data can be read. Example: When reading two items of setting data, set the number of elements to H'0002.</p>
CRC-16	This check code is calculated with the data from the slave address to the end of the data. For details on the CRC-16 calculation, see <i>CRC-16 Calculation Example</i> in <i>4.1 Data Format</i> on page 5-3.

## Response Frame

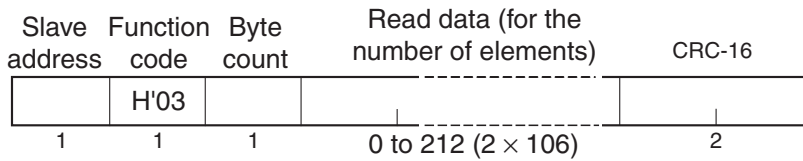

Name	Description
Slave address	The value from the command frame is entered as-is.
Function code	This is the received function code. When the function ended normally, the function code is left as-is. When an error occurred, the hexadecimal value of H'80 is added to the function code to indicate that the response is an error response. Example: Received function code = H'03 Function code in response frame when an error occurred = H'83
Byte count	Contains the number of bytes of read data.
Number of elements	Contains the number of setting data items that were read.
CRC-16	This check code is calculated with the data from the slave address to the end of the data. For details on the CRC-16 calculation, see <i>CRC-16 Calculation Example</i> in 4.1 Data Format on page 5-3.

## Response Code

Function code	Error code	Error name	Cause
H'83	H'02	Variable address error	The read start variable address is incorrect. <ul style="list-style-type: none"> <li>The variable area number is incorrect.</li> </ul>
	H'03	Variable data error	The number of elements exceeds the allowed range.
H'03	---	Normal completion	No errors were found.

## ◆ Reading Undisplayed Parameters

It is possible to read the parameters that are not displayed due to display settings as well as the parameters that are never displayed in the Controller.

## Example Command and Response

The following example shows the command and response when reading the process value (slave address: H'01).

## Process Value in Four-byte Mode

- Address: H'0000; Read data: H'000003E8 (100.0 °C)

Command: 01 03 00 00 00 02 C4 0B(CRC-16)

Response: 01 03 04 00 00 03 E8 FA 8D(CRC-16)

## Process Value in Two-byte Mode

- Address: H'2000; Read data: H'03E8 (100.0 °C)

Command: 01 03 00 00 00 01 8F CA (CRC-16)

Response: 01 03 02 03 E8 B8 FA (CRC-16)

## Variable Write, Multiple

To write data to the variable area, set the required data in the command frame, as shown in the following diagram.

### Command Frame

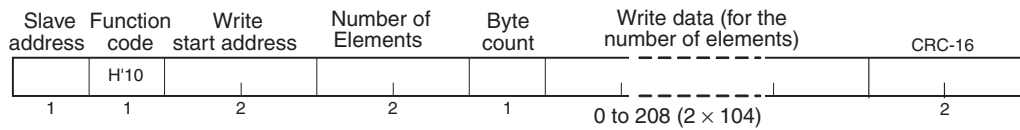

Name	Description
Slave address	Specify the E5CN/AN/EN-HT's unit number. The unit number can be set between H'01 and H'63 hexadecimal (1 to 99 decimal).
Function code	The Write Variable Area function's function code is H'10.
Write start address	Specify the starting address where the setting data will be written. See <i>SECTION 5 Communications Data for Modbus</i> for details on addresses.
Number of elements	<p>Four-byte Mode</p> <p>Specify 2 times the number of setting data items as the number of elements to be written.</p> <p>The setting range for the number of elements is H'0002 to H'0068 (2 to 104).</p> <p>When H'0068 is set, 52 items of setting data can be read.</p> <p>Example: When writing 2 items of setting data, set the number of elements to H'0004.</p>
	<p>Two-byte Mode</p> <p>Specify the number of setting data items to be written as the number of elements.</p> <p>The setting range for the number of elements is H'0001 to H'0068 (1 to 104).</p> <p>When H'0068 is set, 104 items of setting data can be read.</p> <p>Example: When reading two items of setting data, set the number of elements to H'0002.</p>
Byte count	Specify the number of bytes of write data.
CRC-16	This check code is calculated with the data from the slave address to the end of the data. For details on the CRC-16 calculation, see <i>CRC-16 Calculation Example</i> in <i>4.1 Data Format</i> on page 5-3.

## Response Frame

Slave address	Function code	Write start address	Number of Elements	CRC-16
	H'10			
1	1	2	2	2 bytes

Name	Description
Slave address	The value from the command frame is entered as-is.
Function code	This is the received function code. When the function ended normally, the function code is left as-is. When an error occurred, the hexadecimal value of H'80 is added to the function code to indicate that the response is an error response. Example: Received function code = H'10 Function code in response frame when an error occurred = H'90
Write start address	This is the received write start address.
Number of elements	This is the received number of elements.
CRC-16	This check code is calculated with the data from the slave address to the end of the data. For details on the CRC-16 calculation, see <i>CRC-16 Calculation Example</i> in 4.1 <i>Data Format</i> on page 5-3.



## Response Code

Function code	Error code	Error name	Cause
H'90	H'02	Variable address error	The write start variable address is incorrect. <ul style="list-style-type: none"> <li>The variable area number is incorrect.</li> </ul>
	H'03	Variable data error	<ul style="list-style-type: none"> <li>The amount of data does not match the number of elements.</li> <li>The byte count is not 2 times the number of elements.</li> <li>The write data is out of the setting range.</li> </ul>
	H'04	Operation error	The Controller cannot write the data in its present operating status. The write data contents are not allowed in the present operation mode. <ul style="list-style-type: none"> <li>The Communications Writing parameter is set to "OFF" (disabled).</li> <li>Attempted to write to a parameter in setup area 1 from setup area 0.</li> <li>Attempted to write to a protect parameter from other than the protect level.</li> <li>AT execution in progress</li> <li>The program number was written during operation.</li> </ul>
H'10	---	Normal completion	No errors were found.

## ◆ Writing Undisplayed Parameters

It is possible to write the parameters that are not displayed due to display settings as well as the parameters that are never displayed in the Controller.

## Example Command and Response

The following example shows the command/response when writing the Alarm Value Upper Limit 1 and Alarm Value Lower Limit 1 parameters. (In this case, the slave address is H'01.)

**Four-byte Mode**

Alarm Value Upper Limit 1

- Address: H'1812; Write data: H'000003E8 (when 1000)

Alarm Value Lower Limit 1

- Address: H'1814; Write data: H'FFFFFFC18 (when -1000)

Command: 01 10 18 12 00 04 08 00 00 03 E8 FF FF FC 18 8E 9C(CRC-16)

Response: 01 10 18 12 00 04 67 6F(CRC-16)

**Two-byte Mode**

Alarm Value Upper Limit 1

- Address: H'3809; Write data: H'03E8 (when 1000)

Alarm Value Lower Limit 1

- Address: H'380A; Write data: H' FC18 (when –1000)

Command: 01 10 38 09 00 02 04 03 E8 FC 18 C1 72 (CRC-16)

Response: 01 10 38 09 00 02 9C AA (CRC-16)

## ■ Variable Write, Single/Operation Command

This function performs operations such as writing to the variable area (single) and operation commands (Communications Writing, Run/Reset, AT Execute/Cancel, Write Mode, Save RAM Data, Software Reset, Move to Setup Area 1, Move to Protect Level, Auto/Manual Switch, Initialize Settings, Alarm Latch Cancel, SP Mode, Invert Direct/Reverse Operation, Infrared Communications Use, Hold, and Advance). Writing is enabled in only the Two-byte Mode.

Command Frame

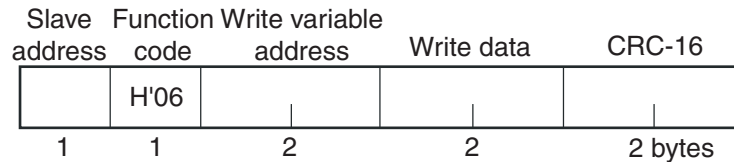

Response Frame

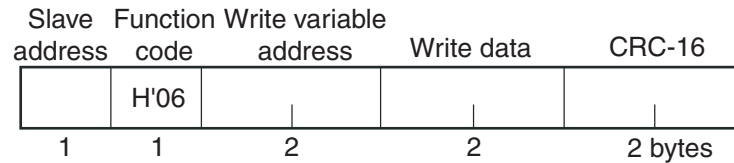

(1) Write variable address

Specify the address of the setting data that is to be written. For details on addresses, refer to *Section 5 Communications Data for Modbus*.

For an operation command, specify 0000 or FFFF.

(2) Command Code and Related Information

Command code	Command content	Related information
00	Communications writing	00: OFF (disabled) 01: ON (enabled)
01	Run/Reset	00: Run 01: Reset
03	AT execute/cancel	00: AT cancel 01: 100% AT execute 02: 40% AT execute
04	Write mode	00: Backup mode 01: RAM write mode
05	Save RAM data	00
06	Software reset	00
07	Move to setup area 1	00
08	Move to protect level	00

Command code	Command content	Related information
09	Auto/manual switch	00: Automatic mode 01: Manual mode
0B	Parameter initialization	00: Initialize to defaults
0C	Alarm latch cancel	00: Alarm 1 latch cancel 01: Alarm 2 latch cancel 02: Alarm 3 latch cancel 03: HB alarm latch cancel 04: HS alarm latch cancel 05: OC alarm latch cancel 0F: All alarm latch cancel
0D	SP mode	00: Program SP mode 01: Remote SP mode 02: Fixed SP mode
0E	Invert direct/reverse operation	00: Not invert 01: Invert
12	Infrared communications use	00: OFF 01: ON
13	Hold	00: Clear hold 01: Hold
14	Advance	00

## (2) Response Code

## Normal Completion

Function code	Error code	Name	Description
H'06	---	Normal completion	No errors were found.

## Error Occurred

Function code	Error code	Name	Description
H'86	H'02	Variable address error	The write variable address is incorrect. The variable area number (2-byte data) is wrong, or the address is not 0000 or FFFF.
	H'03	Variable data error	The write data is incorrect. <ul style="list-style-type: none"> <li>The write data is out of the setting range.</li> <li>Command code or related information are incorrect.</li> </ul>
	H'04	Operation error	The Controller cannot write the data in its present operating status. <ul style="list-style-type: none"> <li>The Communications Writing parameter is set to "OFF" (disabled). The command is received regardless of the Communications Writing parameter setting (ON/OFF).</li> <li>Writing was attempted from setup area 0 to setup area 1.</li> <li>AT execution was in progress.</li> <li>Processing could not be performed. For details, see (4) <i>Operation Commands and Precautions</i> below.</li> </ul>

Note: For details on variable writing, refer to *Variable Write, Multiple* on page 4-11. For details on AT, refer to *E5CN/AN/EN-HT Digital Controllers Program Type User's Manual* (Cat. No. H169).

## (3) Example Command and Response

The following example shows the command/response for a Reset command. (In this case, the slave address is H'01.)

Reset command (command code: 01; related information: 01)

•Address: H'0000 (fixed)

Write data: H'0101 (Run/Reset, Reset command)

Command: 01 06 00 00 01 01 49 9A(CRC-16)

Response: 01 06 00 00 01 01 49 9A(CRC-16)

## (4) Operation Commands and Precautions

## ● Communications Writing

Set the Communications Writing parameter to "ON" (enabled) or "OFF" (disabled) with the related information setting.

The setting can be accepted in both setup area 0 and setup area 1. An operation error will occur, however, if communications writing enable/disable is set for an event input.

## ● Run/Reset

Set control to "run" or "stop" with the related information setting. The setting can be accepted in both setup area 0 and setup area 1.

#### ● AT Execute/Cancel

Set AT (auto-tuning) to “execute” or “cancel” with the related information setting. This command can be accepted in setup area 0 only. An “operation error” will be generated in the following instances:

- When the Run/Reset parameter is set to Reset (and the reset operation is set to stop control).
- During standby status (when the reset operation is set to stop control).
- In Manual Mode or when executing from setup area 1.
- When ON/OFF control is being used
- When 40% AT is specified during 100% AT execution.
- When 100% AT is specified during 40% AT execution.
- When 100% AT execute/cancel or 40% AT execute/cancel is assigned to an event input.

In addition, a variable data error will occur if 40% AT is specified during heating and cooling control or during position-proportional floating control.

**Note:** If the same type of AT execution is specified during AT execution (e.g., if 100% AT execution is specified during 100% AT execution), the AT will not be restarted and the operation will end in normal completion with no processing.

#### ● Write Mode

Set either “backup mode” or “RAM write mode” with the related information setting. The setting can be accepted in both setup area 0 and setup area 1.

The number of non-volatile memory write operations is limited. Therefore, use RAM write mode when frequently overwriting data.

Write mode	Description
Backup mode	The data is written to non-volatile memory when a parameter in the operation, adjustment, program setting, or PID setting level (excluding read-only parameters) is written using communications.
RAM write mode	The data is not written to non-volatile memory when a parameter in the operation, adjustment, program setting, or PID setting level (excluding read-only parameters) is written using communications. Parameters can be changed by using key operations on the front panel of the Controller.

- When you switch from RAM Write Mode to Backup Mode, the parameters in the operation, adjustment, program setting, and PID setting levels (excluding read-only parameters) are written to non-volatile memory.

- RAM write mode is enabled only when communications are enabled in the Communications Writing parameter (i.e., set to ON). Therefore, if the Communications Writing parameter is changed to OFF (disabled), the parameter settings from the operation, adjustment, program setting, and PID setting levels (excluding read-only parameters) are written to non-volatile memory even if the RAM write mode is set.

- RAM Data

This command writes the parameters in the operation, adjustment, program setting, and PID setting levels (excluding read-only parameters) to non-volatile memory. The setting can be accepted in both setup area 0 and setup area 1.

- Software Reset

Restarts processing from the point when power is turned ON. The setting can be accepted in both setup area 0 and setup area 1.

- Move to Setup Area 1

This command moves to “setup area 1” and can be accepted at both setup areas 0 and 1. If the “initial setting/communications protect” is set to “2,” an “operation error” will be generated, and the move to setup area 1 will be prohibited.

When this move is carried out from setup area 0, the display indicates the “input type” in the “initial setting level.” When this operation command is executed in setup area 1, the display will not change.

- Move to Protect Level

This command moves to the “protect level” and can be accepted only in setup area 0. When this command is issued in setup area 1, an “operation error” will be generated, and the move to the protect level will be prohibited.

- Auto/Manual Switch

This operation command switches the mode to manual mode or automatic mode, based on the related information setting. This command can be accepted in setup area 0 only. An “operation error” will be generated in the following instances:

- When the command is executed in “Setup Area 1”
- When auto/manual switching is disabled (not displayed)

When the Controller is switched to manual mode, the “manual manipulated variable” will be displayed. When the Controller is switched from manual mode to automatic mode, the operation level’s first parameter will be displayed. When the Controller is switched to manual mode

while already in manual mode, the command will be completed normally and the display will not change (the contents will not be refreshed).

◆ Switching to Manual Mode during Auto-tuning

If the mode is switched during auto-tuning (AT), the AT will be cancelled and the Controller will be switched to manual mode.

● Parameter Initialization

The present settings are returned to the default values and written to non-volatile memory. This command can be accepted in setup area 1 only. When this command is issued in setup area 0, an “operation error” will be generated.

Related information	Explanation (initialization values)
00	Default set values (See <i>SECTION 3 Communications Data for CompoWay/F</i> for details.) (These settings are the same as the ones used when “FACT” is selected for the setting data’s set value initialization.)

● Alarm Latch Cancel

The applicable alarm latch can be cleared with the related information setting. The setting can be accepted in both setup area 0 and setup area 1. An operation error will occur if communications writing is disabled or if a non-volatile memory error occurs.

● SP Mode

Select program SP mode, remote SP mode, or fixed SP mode with the related information setting. The setting can be accepted in both setup area 0 and setup area 1. An operation error will occur in the following situations.

- When AT is being executed
- When the SP Mode parameter is disabled (not displayed at the Controller)

● Invert Direct/Reverse Operation

Inverting or not inverting direct/reverse operation can be selected with the related information setting. The setting can be accepted in both setup area 0 and setup area 1. The related information specifications are written to non-volatile memory according to the write mode settings. An operation error will occur in the following situations:

- When AT is being executed.
- When inverting direct/reverse operation is set for an event input.
- When executed in manual mode.

#### ● Infrared Communications Use

Select ON or OFF to enable or disable using infrared communications with the related information setting. The setting can be accepted in both setup area 0 and setup area 1.

#### ● Hold

Turn the hold operation ON or OFF with the related information setting. The setting can be made only in setup area 0.

An operation error will occur in the following situations.

- When AT is being executed
- During standby status
- During a reset or when continuing control at the end of operation
- When Hold/Clear Hold is assigned to an event input

#### ● Advance

This operation command performs the advance operation. The setting can be made only in setup area 0.

An operation error will occur in the following situations.

- When AT is being executed
- During standby status
- During a reset or when continuing control at the end of operation

#### ● Setting Areas

Control operation is executed in setting area 0. In this state, you can perform operations that are permitted only during control or those that cause no problems even if control is in progress. These operations include reading PVs, writing SPs, and changing Run/Reset status.

Setting area 0, however, prohibits operations that affect control, including writing data at the initial setting level. (Reading setting data is always allowed.)

In setting area 1, control operation is stopped. In this state, you can perform operations that are not allowed in setting area 0. These operations include writing data at the initial setting level.

At power-ON, the Digital Controller is set in setting area 0. To move to setting area 1, use the “move-to-setting area 1” command. To return to setting area 0, turn the power OFF and ON again, or use the “software reset” command.

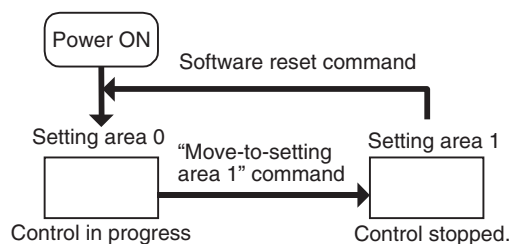



## ■ Echoback Test

### Command Frame

Slave address	Function code	Write start address	Test data	CRC-16
1	H'08	H'00 H'00	2	2 bytes

### Response Frame

Slave address	Function code	Write start address	Test data	CRC-16
1	H'08	H'00 H'00	2	2 bytes

\* When the command is executed normally, the response returns the same data sent in the command.

#### (1) Test Data

Enter any 2-byte hexadecimal data.

#### (2) Response Code

Function code	Error code	Name	Description
H'88	H'03	Variable data error	The data following the function code was not the fixed data (H'00, H'00).
H'08	---	Normal completion	No errors were found.

#### (3) Example Command and Response

The following example shows the command/response for an Echoback Test command.

(In this case, the test data is H'1234.)

(In this case, the slave address is H'01.)

Command: 01 08 00 00 12 34 ED 7C(CRC-16)  
 Response: 01 08 00 00 12 34 ED 7C(CRC-16)



# SECTION 5

## Communications Data for Modbus

This section lists the details of the communications data in the Modbus communications protocol.

5.1	Variable Area (Setting Range) List .....	5-2
5.2	Status and Status 2 .....	5-16
	Status Structure .....	5-16
	Status 2 Structure .....	5-18
	Status Details .....	5-19
	Status 2 Details .....	5-20

## 5.1 Variable Area (Setting Range) List

- Four-byte Mode

One element uses 2 bytes of data (H'0000 to H'FFFF), so specify two-element units. Reading and writing in 4-byte units is executed by specifying an even address and specifying the number of elements in multiples of 2.

- Two-byte Mode

One element uses 2 bytes of data (H'0000 to H'FFFF), so specify one-element units. Reading and writing in 2-byte data units is executed by specifying 1-element units.

The following table lists the variable area. Items expressed in hexadecimal in the “Set (monitor) value” column are the setting range in the Modbus specifications. Values in parentheses “( )” are the actual setting range.

When there is a section reference for a setting item, refer to that reference for details.

Address		Parameter name	Setting (monitor) value	Level
Four-byte mode	Two-byte mode			
0000	2000	Process Value	Temperature: Use the specified range for each sensor. Analog: Scaling lower limit -5% FS to Scaling upper limit +5% FS	Operation
0002	2001	Status (See notes 1 and 2.)	See the 5.2 <i>Status and Status 2</i> for details.	None
0004	2002	Present SP	SP lower limit to SP upper limit	Operation
0006	2003	Heater Current 1 Value Monitor	H'00000000 to H'00000226 (0.0 to 55.0)	
0008	2004	MV Monitor (Heating)	Standard: H'FFFFFFCE to H'0000041A (-5.0 to 105.0) Heating/cooling: H'00000000 to H'0000041A (0.0 to 105.0)	
000A	2005	MV Monitor (Cooling)	H'00000000 to H'0000041A (0.0 to 105.0)	
0404	2402	PV	Temperature: Use the specified range for each sensor. Analog: Scaling lower limit -5% FS to Scaling upper limit +5% FS	
0406	2403	Present SP	SP lower limit to SP upper limit	
0408	2404	Program No. Monitor	H'00000000 to H'00000007 (0 to 7)	
040A	2405	PID Set No. Monitor	H'00000001 to H'00000008 (1 to 8)	
040C	2406	Status (See notes 1 and 2.)	See the 5.2 <i>Status and Status 2</i> for details.	
040E	2407	Status (See note 3.)	See the 5.2 <i>Status and Status 2</i> for details.	
0410	2408	Status 2 (See note 2.)	See the 5.2 <i>Status and Status 2</i> for details.	
0412	2409	Status 2 (See note 3.)	See the 5.2 <i>Status and Status 2</i> for details.	
0420	2410	Decimal Point Monitor	H'00000000 to H'00000003 (0 to 3)	
0422	2411	Control Output 1 ON/OFF Count Monitor	H'00000000 to H'0000270F (0 to 9999)	Advanced function setting
0424	2412	Control Output 2 ON/OFF Count Monitor	H'00000000 to H'0000270F (0 to 9999)	

Note 1: Not displayed on the Controller display.

Note 2: In 2-byte mode, the rightmost 16 bits are read.

Note 3: In 2-byte mode, the leftmost 16 bits are read.

Address		Parameter name	Setting (monitor) value	Level
Four-byte mode	Two-byte mode			
0500	2500	Operation/Adjustment Protect	H'00000000(0) to H'00000005(5) 0: No control 1: Run level (PV allowed, PV/SP allowed, others allowed), program level allowed, adjustment level allowed, PID setting level prohibited 2: Run level (PV allowed, PV/SP allowed, others allowed), program level allowed, adjustment level prohibited, PID setting level prohibited 3: Run level (PV allowed, PV/SP allowed, others allowed), program level prohibited, adjustment level prohibited, PID setting level prohibited 4: Run level (PV allowed, PV/SP allowed, others prohibited), program level prohibited, adjustment level prohibited, PID setting level prohibited 5: Run level (PV allowed, PV/SP prohibited, others prohibited), program level prohibited, adjustment level prohibited, PID setting level prohibited	Protect
0502	2501	Initial Setting/Communications Protect	H'00000000 (0): Move to initial setting/communications setting level is allowed. (Move to advanced function setting level is displayed.) H'00000001 (1): Move to initial setting/communications setting level is allowed. (Move to advanced function setting level is not displayed.) H'00000002 (2): Move to initial setting/communications setting level is prohibited.	
0504	2502	Setting Change Protect	H'00000000 (0): OFF (Changing of setup on controller display is allowed.) H'00000001 (1): ON (Changing of setup on controller display is prohibited.)	
0506	2503	PF Key Protect	H'00000000 (0): OFF H'00000001 (1): ON	
0508	2504	Move to Protect Level	H'FFFFFF831 to H'0000270F (-1999 to 9999)	
050A	2505	Password to Move to Protect Level	H'FFFFFF831 to H'0000270F (-1999 to 9999) (Can only be set. The monitor value is always H'00000000.)	
050C	2506	Parameter Mask Enable	H'00000000 (0): OFF H'00000001 (1): ON	
0600	2600	Manual MV	Standard: H'FFFFFFFCE to H'0000041A (-5.0 to 105.0) Heating/cooling: H'FFFFFFBE6 to H'0000041A (-105.0 to 105.0) Position proportional (Closed and direct setting of position proportional MV ON): H'FFFFFFFCE to H'0000041A (-5.0 to 105.0)	Manual Control
0604	2602	Remote SP Monitor	SP Lower Limit to SP Upper Limit	Operation
0608	2604	Heater Current 1 Value Monitor	H'00000000 to H'00000226 (0.0 to 55.0)	
060A	2605	MV Monitor (Heating)	Standard: H'FFFFFFFCE to H'0000041A (-5.0 to 105.0) Heating and cooling: H'00000000 to H'0000041A (0.0 to 105.0)	
060C	2606	MV Monitor (Cooling)	H'00000000 to H'0000041A (0.0 to 105.0)	
060E	2607	Valve Opening Monitor	H'FFFFFFF9C to H'0000044C (-10.0 to 110.0)	
0610	2608	Program No.	H'00000000 to H'00000007 (0 to 7)	
0612	2609	Segment No. Monitor	H'00000000 to H'0000001F (0 to 31)	
0614	260A	Remaining Standby Time Monitor	H'00000000 to H'00009959 (hours, minutes) H'00000000 to H'00009923 (days, hours)	
0616	260B	Elapsed Program Time Monitor	H'00000000 to H'00009959 (hours, minutes) H'00000000 to H'00009923 (days, hours)	
0618	260C	Remaining Program Time Monitor	H'00000000 to H'00009959 (hours, minutes) H'00000000 to H'00009923 (days, hours)	None
061A	260D	Elapsed Segment Time Monitor	H'00000000 to H'00009959 (hours, minutes) H'00000000 to H'00009923 (days, hours)	
061C	260E	Remaining Segment Time Monitor	H'00000000 to H'00009959 (hours, minutes) H'00000000 to H'00009923 (days, hours)	
061E	260F	Program Repetitions Monitor	H'00000000 to H'0000270F (0 to 9999)	Operation
0620	2610	SP Mode Setting Monitor	H'00000000 (0): Program SP mode H'00000001 (1): Remote SP mode H'00000002 (2): Fixed SP mode	None

## SECTION 5 Communications Data for Modbus

Address		Parameter name	Setting (monitor) value	Level
Four-byte mode	Two-byte mode			
0700	2700	Cooling Coefficient (See note 1.)	H'00000001 to H'0000270F (0.01 to 99.99)	Adjustment
0708	2704	Dead Band	Temperature: H'FFFFB1E1 to H'00007E90 (-1999.9 to 3240.0) Analog: H'FFFFFF831 to H'0000270F (-19.99 to 99.99)	
070A	2705	Manual Reset Value	H'00000000 to H'000003E8 (0.0 to 100.0)	
070C	2706	Hysteresis (Heating)	Temperature: H'00000001 to H'00007E90 (0.1 to 3240.0) Analog: H'00000001 to H'0000270F (0.01 to 99.99)	
070E	2707	Hysteresis (Cooling)	Temperature: H'00000001 to H'00007E90 (0.1 to 3240.0) Analog: H'00000001 to H'0000270F (0.01 to 99.99)	
0710	2708	Control Period (Heating)	H'00000000 (0): 0.5 H'00000001 to H'00000063 (1 to 99)	Initial setting
0712	2709	Control Period (Cooling)	H'00000000 (0): 0.5 H'00000001 to H'00000063 (1 to 99)	
0714	270A	Position Proportional Dead Band	H'00000001 to H'00000064 (0.1 to 10.0)	Adjustment
0716	270B	Open/Close Hysteresis	H'00000001 to H'000000C8 (0.1 to 20.0)	
071E	270F	MV at Reset	Standard: H'FFFFFFCE to H'0000041A (-5.0 to 105.0) Heating/cooling: H'FFFFBE6 to H'0000041A (-105.0 to 105.0) Position proportional (Floating or direct setting of position proportional MV OFF): H'FFFFFFF to H'00000001 (-1 to 1) Position proportional (Closed and direct setting of position proportional MV ON): H'FFFFFFCE to H'0000041A (-5.0 to 105.0)	Adjustment

Note 1: The parameter for the currently selected PID set will be accessed. For setup area 1, however, the currently selected PID set is fixed at PID1.

Address		Parameter name	Setting (monitor) value	Level
Four-byte mode	Two-byte mode			
0722	2711	MV at PV Error	Standard: H'FFFFFFCE to H'0000041A (-5.0 to 105.0) Heating/cooling: H'FFFFFFBE6 to H'0000041A (-105.0 to 105.0) Position proportional (Floating or direct setting of position proportional MV OFF): H'FFFFFFF to H'00000001 (-1 to 1) Position proportional (Closed and direct setting of position proportional MV ON): H'FFFFFFCE to H'0000041A (-5.0 to 105.0)	Adjustment
0726	2713	MV Change Rate Limit	H'00000000 to H'000003E8 (0.0 to 100.0)	
072C	2716	Lower Limit Temperature Input Shift Value	H'FFFFB1E1 to H'00007E90 (-199.99 to 324.00)	
0730	2718	Upper Limit Temperature Input Shift Value	H'FFFFB1E1 to H'00007E90 (-199.99 to 324.00)	
0734	271A	Heater Current 1 Value Monitor	H'00000000 to H'00000226 (0.0 to 55.0)	Operation
0736	271B	Heater Burnout Detection 1	H'00000000 to H'000001F4 (0.0 to 50.0)	Adjustment
0738	271C	Leakage Current 1 Monitor	H'00000000 to H'00000226 (0.0 to 55.0)	Operation
073A	271D	HS Alarm 1	H'00000000 to H'000001F4 (0.0 to 50.0)	Adjustment
0746	2723	Temperature Input Shift	H'FFFFB1E1 to H'00007E90 (-199.99 to 324.00)	Operation
0748	2724	Heater Current 2 Value Monitor	H'00000000 to H'00000226 (0.0 to 55.0)	
074A	2725	Heater Burnout Detection 2	H'00000000 to H'000001F4 (0.0 to 50.0)	Adjustment
074C	2726	Leakage Current 2 Monitor	H'00000000 to H'00000226 (0.0 to 55.0)	Operation
074E	2727	HS Alarm 2	H'00000000 to H'000001F4 (0.0 to 50.0)	Adjustment
0754	272A	Wait Band	H'00000000 (0): OFF Temperature: H'00000001 to H'00007E90 (0.1 to 3240.0) Analog: H'00000001 to H'0000270F (0.01 to 99.99)	Advanced function setting
0756	272B	Heater Overcurrent Detection 1	H'00000000 to H'000001F4 (0.0 to 50.0)	
0758	272C	Heater Overcurrent Detection 2	H'00000000 to H'000001F4 (0.0 to 50.0)	
075A	272D	Fixed SP	SP lower limit to SP upper limit	
075C	272E	Standby Time	H'00000000 to H'00009959 (hours, minutes) H'00000000 to H'00009923 (days, hours)	
075E	272F	Program SP Shift Value	H'FFFFB1E1 to H'00007E90 (-19999 to 32400)	
0800	2800	Input Digital Filter	H'00000000 to H'0000270F (0.0 to 999.9)	
0810	2808	Extraction of Square Root Low-cut Point	H'00000000 to H'000003E8 (0.0 to 100.0)	Adjustment
0838	281C	RSP 0 before Correction	Remote SP lower limit to remote SP upper limit	
083A	281D	RSP 1 before Correction	Remote SP lower limit to remote SP upper limit	
083C	281E	RSP 2 before Correction	Remote SP lower limit to remote SP upper limit	
083E	281F	RSP 3 before Correction	Remote SP lower limit to remote SP upper limit	
0840	2820	RSP 4 before Correction	Remote SP lower limit to remote SP upper limit	
0842	2821	RSP 5 before Correction	Remote SP lower limit to remote SP upper limit	
0844	2822	RSP 6 before Correction	Remote SP lower limit to remote SP upper limit	
0846	2823	RSP 7 before Correction	Remote SP lower limit to remote SP upper limit	
0848	2824	RSP 8 before Correction	Remote SP lower limit to remote SP upper limit	
084A	2825	RSP 9 before Correction	Remote SP lower limit to remote SP upper limit	
084C	2826	RSP 10 before Correction	Remote SP lower limit to remote SP upper limit	
084E	2827	RSP Broken-line Correction Value 0	H'FFFFB1E1 to H'00007E90 (-19999 to 32400)	
0850	2828	RSP Broken-line Correction Value 1	H'FFFFB1E1 to H'00007E90 (-19999 to 32400)	
0852	2829	RSP Broken-line Correction Value 2	H'FFFFB1E1 to H'00007E90 (-19999 to 32400)	
0854	282A	RSP Broken-line Correction Value 3	H'FFFFB1E1 to H'00007E90 (-19999 to 32400)	
0856	282B	RSP Broken-line Correction Value 4	H'FFFFB1E1 to H'00007E90 (-19999 to 32400)	
0858	282C	RSP Broken-line Correction Value 5	H'FFFFB1E1 to H'00007E90 (-19999 to 32400)	
085A	282D	RSP Broken-line Correction Value 6	H'FFFFB1E1 to H'00007E90 (-19999 to 32400)	
085C	282E	RSP Broken-line Correction Value 7	H'FFFFB1E1 to H'00007E90 (-19999 to 32400)	
085E	282F	RSP Broken-line Correction Value 8	H'FFFFB1E1 to H'00007E90 (-19999 to 32400)	
0860	2830	RSP Broken-line Correction Value 9	H'FFFFB1E1 to H'00007E90 (-19999 to 32400)	
0862	2831	RSP Broken-line Correction Value 10	H'FFFFB1E1 to H'00007E90 (-19999 to 32400)	
1800	3800	Program Selection	H'00000000 to H'00000007 (0 to 7)	Program

Address		Parameter name	Setting (monitor) value	Level
Four-byte mode	Two-byte mode			
1802	3801	No. of Segments Used (See note 1.)	H'00000001 to H'00000020 (32)	Program
1804	3802	Segment Selection (See note 1.)	H'00000000 to H'0000001F (31)	
1806	3803	Segment Type (See note 2.)	H'00000000 (0): Ramp H'00000001 (1): Soak H'00000002 (2): Step	
1808	3804	Segment SP (See note 2.)	SP lower limit to SP upper limit	
180A	3805	Segment Slope (See note 2.)	H'00000000 to H'00007E90 (0 to 32400)	
180C	3806	Segment Time (See note 2.)	H'00000000 to H'00009959 (0.00 to 99.59) (hours, minutes) H'00000000 to H'00009959 (0.00 to 99.59) (minutes, seconds)	
180E	3807	PID Set No. (See note 1.)	H'00000000 to H'00000008 (0 to 8) (0): Automatic Selection	
1810	3808	Alarm Value 1 (See note 1.)	H'FFFFB1E1 to H'00007E90 (-19999 to 32400)	
1812	3809	Alarm Value Upper Limit 1 (See note 1.)	H'FFFFB1E1 to H'00007E90 (-19999 to 32400)	
1814	380A	Alarm Value Lower Limit 1 (See note 1.)	H'FFFFB1E1 to H'00007E90 (-19999 to 32400)	
1816	380B	Alarm Value 2 (See note 1.)	H'FFFFB1E1 to H'00007E90 (-19999 to 32400)	
1818	380C	Alarm Value Upper Limit 2 (See note 1.)	H'FFFFB1E1 to H'00007E90 (-19999 to 32400)	
181A	380D	Alarm Value Lower Limit 2 (See note 1.)	H'FFFFB1E1 to H'00007E90 (-19999 to 32400)	
181C	380E	Alarm Value 3 (See note 1.)	H'FFFFB1E1 to H'00007E90 (-19999 to 32400)	
181E	380F	Alarm Value Upper Limit 3 (See note 1.)	H'FFFFB1E1 to H'00007E90 (-19999 to 32400)	
1820	3810	Alarm Value Lower Limit 3 (See note 1.)	H'FFFFB1E1 to H'00007E90 (-19999 to 32400)	
1822	3811	Program Repetitions (See note 1.)	'00000000 to '0000270F (0 to 9999)	
1824	3812	Program Link Destination No. (See note 1.)	H'FFFFFFF(-1): No link H'00000000 to H'00000007 (0 to 7)	
1826	3813	Time Signal 1 Set Segment (See note 1.)	H'00000000 (0) to No. of segments used -1	
1828	3814	Time Signal 1 ON Time (See note 1.)	H'00000000 to H'00009959 (0.00 to 99.59) (hours, minutes) H'00000000 to H'00009959 (0.00 to 99.59) (minutes, seconds)	
182A	3815	Time Signal 1 OFF Time (See note 1.)	H'00000000 to H'00009959 (0.00 to 99.59) (hours, minutes) H'00000000 to H'00009959 (0.00 to 99.59) (minutes, seconds)	
182C	3816	Time Signal 2 Set Segment (See note 1.)	H'00000000 (0) to No. of segments used -1	
182E	3817	Time Signal 2 ON Time (See note 1.)	H'00000000 to H'00009959 (0.00 to 99.59) (hours, minutes) H'00000000 to H'00009959 (0.00 to 99.59) (minutes, seconds)	
1830	3818	Time Signal 2 OFF Time (See note 1.)	H'00000000 to H'00009959 (0.00 to 99.59) (hours, minutes) H'00000000 to H'00009959 (0.00 to 99.59) (minutes, seconds)	
0A00	2A00	Proportional Band (See note 3.)	Temperature: H'00000001 to H'00007E90 (0.1 to 3240.0) Analog: H'00000001 to H'0000270F (0.1 to 999.9)	Adjustment
0A02	2A01	Integral Time (See note 3.)	Standard, heating/cooling, position proportional (closed): H'00000000 to H'00007E90 (0.0 to 3240.0) Position proportional (floating): H'00000001 to H'00007E90 (0.1 to 3240.0)	
0A04	2A02	Derivative Time (See note 3.)	H'00000000 to H'00007E90 (0.0 to 3240.0)	
0A0A	2A05	MV Upper Limit (See note 3.)	Standard: MV lower limit +0.1 to H'0000041A (MV lower limit +0.1 to 105.0) Heating/cooling: H'00000000 to H'0000041A (0.0 to 105.0) Position proportional (closed): MV lower limit +0.1 to H'0000041A (MV lower limit +0.1 to 105.0)	

Note: The alarm function can also be used in Controllers without alarm output terminals. In this case, confirm alarm occurrences via the status data.

Note 1: The set values for the program specified in the Program Selection parameter are accessed for the following parameters: No. of Segments Used, Segment Selection, PID Set No., Alarm Values 1 to 3, Alarm Upper Limits 1 to 3, Alarm Lower Limits 1 to 3, Program Repetitions, Program Link Destination No., Time Signal 1 and 2 Set Segments, Time Signal 1 and 2 ON Times, and Time Signal 1 and 2 OFF Times. Check the set value of the Program Selection parameter before accessing these parameters.

Note 2: The set values for the program specified in the Program Selection parameter and the section specified in the Segment Selection parameter are accessed for the following parameters: Segment Type, Segment SP, Segment Slope, and Segment Time. Check the set values of the Program Selection parameter and the Segment Selection parameter before accessing these parameters.

Note 3: The parameter for the currently selected PID set will be accessed. For setup area 1, however, the currently selected PID set is fixed at PID1.



Address		Parameter name	Setting (monitor) value	Level
Four-byte mode	Two-byte mode			
0A0C	2A06	MV Lower Limit (See note 1.)	Standard: H'FFFFFFCE to MV upper limit -0.1 (-5.0 to MV upper limit -0.1) Heating/cooling: H'FFFFFFBE6 to H'00000000 (-105.0 to 0.0) Position proportional (closed): H'FFFFFFCE to MV upper limit -0.1 (-5.0 to MV upper limit -0.1)	Adjustment
0C00	2C00	Input Type (See note.)	H'00000000 (0): Pt (-200.0 to 850.0°C/-300.0 to 1500.0°F) H'00000001 (1): Pt (-199.9 to 500.0°C/-199.9 to 900.0°F) H'00000002 (2): Pt (0.0 to 100.0°C/0.0 to 210.0°F) H'00000003 (3): JPt (-199.9 to 500.0°C/-199.9 to 900.0°F) H'00000004 (4): JPt (0.0 to 100.0°C/0.0 to 210.0°F) H'00000005 (5): K (-200.0 to 1300.0°C/-300.0 to 2300.0°F) H'00000006 (6): K (-20.0 to 500.0°C/0.0 to 900.0°F) H'00000007 (7): J (-100.0 to 850.0°C/-100.0 to 1500.0°F) H'00000008 (8): J (-20.0 to 400.0°C/0.0 to 750.0°F) H'00000009 (9): T (-200.0 to 400.0°C/-300.0 to 700.0°F) H'0000000A (10): T (-199.9 to 400.0°C/-199.9 to 700.0°F) H'0000000B (11): E (-200.0 to 600.0°C/-300.0 to 1100.0°F) H'0000000C (12): L (-100.0 to 850.0°C/-100.0 to 1500.0°F) H'0000000D (13): U (-200.0 to 400.0°C/-300.0 to 700.0°F) H'0000000E (14): U (-199.9 to 400.0°C/-199.9 to 700.0°F) H'0000000F (15): N (-200.0 to 1300.0°C/-300.0 to 2300.0°F) H'00000010 (16): R (0.0 to 1700.0°C/0.0 to 3000.0°F) H'00000011 (17): S (0.0 to 1700.0°C/0.0 to 3000.0°F) H'00000012 (18): B (100.0 to 1800.0°C/300.0 to 3200.0°F) H'00000013 (19): W (0.0 to 2300.0°C/0.0 to 3200.0°F) H'00000014 (20): PLII (0.0 to 1300.0°C/0.0 to 2300.0°F) H'00000015 (21): K (-50.00 to 200.00°C/-50.00 to 200.00°F) H'00000016 (22): J (-50.00 to 200.00°C/-50.00 to 200.00°F) H'00000017 (23): T (-50.00 to 200.00°C/-50.00 to 200.00°F) H'00000018 (24): Pt (-50.00 to 200.00°C/-50.00 to 200.00°F) H'00000019 (25): 4 to 20mA H'0000001A (26): 0 to 20mA H'0000001B (27): 1 to 5V H'0000001C (28): 0 to 5V H'0000001D (29): 0 to 10V	Initial setting
0C02	2C01	Temperature Unit	H'00000000 (0): °C H'00000001 (1): °F	
0C12	2C09	Scaling Lower Limit	H'FFFFFFB1E1 to Scaling upper limit -1 (-19999 to Scaling upper limit -1)	
0C16	2C0B	Scaling Upper Limit	Scaling lower limit +1 to H'00007E90 (Scaling lower limit +1 to 32400)	
0C18	2C0C	Decimal Point	H'00000000 to 00000003 (0 to 3)	
0C1A	2C0D	Remote SP Upper Limit	SP lower limit to SP upper limit	Advanced function setting
0C1C	2C0E	Remote SP Lower Limit	SP lower limit to SP upper limit	
0C1E	2C0F	PV Decimal Point Display	H'00000000 (0): OFF H'00000001 (1): ON	
0D06	2D03	Linear Current Output	H'00000000 (0): 4 to 20 mA H'00000001 (1): 0 to 20 mA	Initial setting
0D1E	2D0F	SP Upper Limit	The range of values without decimal point is as follows: Temperature: SP lower limit +1 to Input setting range upper limit Analog: SP lower limit +1 to Scaling upper limit	
0D20	2D10	SP Lower Limit	The range of values without decimal point is as follows: Temperature: Input setting range lower limit to SP upper limit -1 Analog: Scaling lower limit to SP upper limit -1	

Note: The input type can be selected to match the connected sensor.

Note 1: The parameter for the currently selected PID set will be accessed. For setup area 1, however, the currently selected PID set is fixed at PID1.

## SECTION 5 Communications Data for Modbus

Address		Parameter name	Setting (monitor) value	Level
Four-byte mode	Two-byte mode			
0D22	2D11	Standard or Heating/Cooling	H'00000000 (0): Standard H'00000001 (1): Heating/cooling	Initial setting
0D24	2D12	Direct/Reverse Operation	H'00000000 (0): Reverse operation H'00000001 (1): Direct operation	
0D26	2D13	Closed/Floating	H'00000000 (0): Floating H'00000001 (1): Closed	
0D28	2D14	PID ON/OFF	H'00000000 (0): ON/OFF H'00000001 (1): 2 PID control	
0D2C	2D16	Program Time Unit	H'00000000 (0): Hours, minutes H'00000001 (1): Minutes, seconds	
0D2E	2D17	Time Setting/Gradient Setting	H'00000000 (0): Time setting H'00000001 (1): Gradient setting	
0D30	2D18	Gradient Time Setting Unit	H'00000000 (0): Minutes H'00000001 (1): Hours	
0D32	2D19	PV Start	H'00000000 (0): SP-priority SP start H'00000001 (1): Slope-priority PV start	
0D34	2D1A	Reset Operation	H'00000000 (0): Stop control H'00000001 (1): Fixed SP operation	
0E00	2E00	Transfer Output Type	H'00000000 (0): OFF H'00000001 (1): Present SP H'00000002 (2): PV H'00000003 (3): MV (heating) H'00000004 (4): MV (cooling) H'00000005 (5): Valve opening	Advanced function setting
0E0C	2E06	Control Output 1 Assignment	When control output 1 is a linear output: H'00000000 (0): Not assigned. H'00000001 (1): Control output (heating) H'00000002 (2): Control output (cooling) When control output 1 is an ON/OFF output: H'00000000 (0): Not assigned. H'00000001 (1): Control output (heating) H'00000002 (2): Control output (cooling) H'00000003 (3): Alarm 1 H'00000004 (4): Alarm 2 H'00000005 (5): Alarm 3 H'00000006 (6): Program end output H'00000007 (7): Control output ON/OFF count alarm (See note 1.) H'00000008 (8): Stage output H'00000009 (9): Run output H'0000000A (10): Time signal 1 output H'0000000B (11): Time signal 2 output H'0000000C (12): Work bit 1 H'0000000D (13): Work bit 2 H'0000000E (14): Work bit 3 H'0000000F (15): Work bit 4 H'00000010 (16): Work bit 5 H'00000011 (17): Work bit 6 H'00000012 (18): Work bit 7 H'00000013 (19): Work bit 8	
0E0E	2E07	Control Output 2 Assignment	When control output 2 is a linear output: H'00000000 to H'00000002 (0 to 2) (Same as for Control Output 1 Assignment.) When control output 2 is an ON/OFF output: H'00000000 to H'00000013 (0 to 19) (Same as for Control Output 1 Assignment.)	

Note 1: The output turns ON when the status of either the Control Output 1 ON/OFF Count Alarm or the Control Output 2 ON/OFF Count Alarm turns ON.

Address		Parameter name	Setting (monitor) value	Level
Four-byte mode	Two-byte mode			
0E18	2E0C	Event Input Assignment 3	H'00000000 to H'00000015 (0 to 21) H'00000000 (0): None H'00000001 (1): Run (OFF)/reset (ON) H'00000002 (2): Run (ON)/reset (OFF) H'00000003 (3): Auto/manual switch H'00000004 (4): Reset H'00000005 (5): Run H'00000006 (6): Hold/clear hold H'00000007 (7): Hold H'00000008 (8): Advance H'00000009 (9): Program No. switch 0 H'0000000A (10): Program No. switch 1 H'0000000B (11): Program No. switch 2 H'0000000C (12): Invert direct/reverse operation H'0000000D (13): Program SP mode/remote SP mode (See note 1.) H'0000000E (14): Remote SP mode/fixed SP mode (See note 1.) H'0000000F (15): Program SP mode/fixed SP mode H'00000010 (16): 100% AT execute/cancel H'00000011 (17): 40% AT execute/cancel H'00000012 (18): Setting change enable/disable H'00000013 (19): Communications writing enable/disable (See note 2.) H'00000014 (20): Latch cancel H'00000015 (21): Wait enable (ON)/disable (OFF)	Initial setting
0E1A	2E0D	Event Input Assignment 4	H'00000000 to H'00000015 (0 to 21) * Same as for Event Input Assignment 3.	
0E20	2E10	Auxiliary Output 1 Assignment	H'00000000 (0): Not assigned H'00000001 (1): Control output (heating) H'00000002 (2): Control output (cooling) H'00000003 (3): Alarm 1 H'00000004 (4): Alarm 2 H'00000005 (5): Alarm 3 H'00000006 (6): Program end output H'00000007 (7): Control output ON/OFF count alarm (See note 3.) H'00000008 (8): Stage output H'00000009 (9): Run output H'0000000A (10): Time signal 1 output H'0000000B (11): Time signal 2 output H'0000000C (12): Work bit 1 H'0000000D (13): Work bit 2 H'0000000E (14): Work bit 3 H'0000000F (15): Work bit 4 H'00000010 (16): Work bit 5 H'00000011 (17): Work bit 6 H'00000012 (18): Work bit 7 H'00000013 (19): Work bit 8	Advanced function setting
0E22	2E11	Auxiliary Output 2 Assignment	H'00000000 to H'00000013 (0 to 19) (Same settings as the Auxiliary Output 1 Assignment)	
0E24	2E12	Auxiliary Output 3 Assignment	H'00000000 to H'0000000F (0 to 15) (Same settings as the Auxiliary Output 1 Assignment)	
0E28	2E14	Transfer Output Upper Limit	H'FFFFFF831 to H'0000270F (-1999 to 9999) H'FFFFB1E1 to H'00007E90 (-19999 to 32400) (See note 4.)	
0E2A	2E15	Transfer Output Lower Limit	H'FFFFFF831 to H'0000270F (-1999 to 9999) H'FFFFB1E1 to H'00007E90 (-19999 to 32400) (See note 4.)	Initial setting

Note 1: E5AN/EN-HT only.

Note 2: Only with external communications.

Note 3: The output turns ON when the status of either the Control Output 1 ON/OFF Count Alarm or the Control Output 2 ON/OFF Count Alarm turns ON.

Note 4: The setting (monitor) range depends on the transfer output type setting. (For details, refer to *SECTION 5 Parameter* in *E5CN/AN/EN-HT Digital Controllers Program Type User's Manual* (Cat. No. H169).)

SECTION 5 Communications Data for Modbus

Address		Parameter name	Setting (monitor) value	Level
Four-byte mode	Two-byte mode			
0E48	2E24	Extraction of Square Root Enable	H'00000000 (0): OFF H'00000001 (1): ON	Initial setting
0E60	2E30	Travel Time	H'00000001 to H'000003E7 (1 to 999)	
0F00	2F00	Alarm 1 Type	H'00000000 (0): Alarm function OFF H'00000001 (1): Upper and lower limit alarm H'00000002 (2): Upper limit alarm H'00000003 (3): Lower limit alarm H'00000004 (4): Upper and lower limit range alarm H'00000005 (5): Upper and lower limit alarm with standby sequence H'00000006 (6): Upper limit alarm with standby sequence H'00000007 (7): Lower limit alarm with standby sequence H'00000008 (8): Absolute value upper limit alarm H'00000009 (9): Absolute value lower limit alarm H'0000000A (10): Absolute value upper limit alarm with standby sequence H'0000000B (11): Absolute value lower limit alarm with standby sequence H'0000000C (12): LBA (Loop Burnout Alarm) H'0000000D (13): PV change rate alarm H'0000000E (14): RSP absolute value upper limit alarm H'0000000F (15): RSP absolute value lower limit alarm	
0F02	2F01	Alarm 1 Latch	H'00000000 (0): OFF H'00000001 (1): ON	Advanced function setting
0F04	2F02	Alarm 1 Hysteresis	Temperature: H'00000001 to H'00007E90 (0.1 to 3240.0) Analog: H'00000001 to H'0000270F (0.01 to 99.99)	Initial setting
0F06	2F03	Alarm 2 Type	H'00000000 (0): Alarm function OFF H'00000001 (1): Upper and lower limit alarm H'00000002 (2): Upper limit alarm H'00000003 (3): Lower limit alarm H'00000004 (4): Upper and lower limit range alarm H'00000005 (5): Upper and lower limit alarm with standby sequence H'00000006 (6): Upper limit alarm with standby sequence H'00000007 (7): Lower limit alarm with standby sequence H'00000008 (8): Absolute value upper limit alarm H'00000009 (9): Absolute value lower limit alarm H'0000000A (10): Absolute value upper limit alarm with standby sequence H'0000000B (11): Absolute value lower limit alarm with standby sequence H'0000000C (12): No alarm function H'0000000D (13): PV change rate alarm H'0000000E (14): RSP absolute value upper limit alarm H'0000000F (15): RSP absolute value lower limit alarm	Advanced function setting
0F08	2F04	Alarm 2 Latch	H'00000000 (0): OFF H'00000001 (1): ON	
0F0A	2F05	Alarm 2 Hysteresis	Temperature: H'00000001 to H'00007E90 (0.1 to 3240.0) Analog: H'00000001 to H'0000270F (0.01 to 99.99)	
0F0C	2F06	Alarm 3 Type (See note 1.)	Same settings as the alarm 2 type.	Advanced function setting
0F0E	2F07	Alarm 3 Latch (See note 1.)	H'00000000 (0): OFF H'00000001 (1): ON	
0F10	2F08	Alarm 3 Hysteresis (See note 1.)	Temperature: H'00000001 to H'00007E90 (0.1 to 3240.0) Analog: H'00000001 to H'0000270F (0.01 to 99.99)	Initial setting
0F18	2F0C	Standby Sequence Reset	H'00000000 (0): Condition A H'00000001 (1): Condition B	Advanced function setting
0F1A	2F0D	Auxiliary Output 1 Open in Alarm	H'00000000 (0): Close in alarm H'00000001 (1): Open in alarm	
0F1C	2F0E	Auxiliary Output 2 Open in Alarm	H'00000000 (0): Close in alarm H'00000001 (1): Open in alarm	
0F1E	2F0F	Auxiliary Output 3 Open in Alarm (See note 1.)	H'00000000 (0): Close in alarm H'00000001 (1): Open in alarm	

Note 1: Not displayed on the Controller display when Alarm 3 is not assigned to the output.

Address		Parameter name	Setting (monitor) value	Level
Four-byte mode	Two-byte mode			
0F22	2F11	Alarm 1 ON delay	H'00000000 to H'000003E7 (0 to 999)	Advanced function setting
0F24	2F12	Alarm 2 ON delay	H'00000000 to H'000003E7 (0 to 999)	
0F26	2F13	Alarm 3 ON delay (See note 1.)	H'00000000 to H'000003E7 (0 to 999)	
0F2A	2F15	Alarm 1 OFF delay	H'00000000 to H'000003E7 (0 to 999)	
0F2C	2F16	Alarm 2 OFF delay	H'00000000 to H'000003E7 (0 to 999)	
0F2E	2F17	Alarm 3 OFF delay (See note 1.)	H'00000000 to H'000003E7 (0 to 999)	
1000	3000	PV/SP Display Screen Selection	H'00000000 (0): Only PV/SP displayed (no No. 3 display). H'00000001 (1): The PV/SP/Program No. or Segment No., and the PV/SP/MV are displayed in order. H'00000002 (2): The PV/SP/MV and PV/SP/Program No. or Segment No. are displayed in order. H'00000003 (3): Only the PV/SP/Program No. or Segment No. are displayed. H'00000004 (4): Only the PV/SP/MV are displayed. H'00000005 (5): The PV/SP/Program No. or Segment No., and the PV/SP/Remaining segment time are displayed in order. H'00000006 (6): The PV/SP/MV and PV/SP/Remaining Segment Time are displayed in order. H'00000007 (7): Only the PV/SP/Remaining segment time are displayed.	
1002	3001	MV Display Selection	H'00000000 (0): MV (heating) H'00000001 (1): MV (cooling)	
1006	3003	Automatic Display Return Time	H'00000000 (0): OFF H'00000001 to H'00000063 (1 to 99)	
1008	3004	Display Refresh Period	H'00000000 (0):OFF H'00000001 (1): 0.25 H'00000002 (2): 0.5 H'00000003 (3): 1.0	
1010	3008	Additional PV Display	H'00000000 (0): OFF H'00000001 (1): ON	
1016	300B	MV Display	H'00000000 (0): OFF (display of manipulated variable OFF) H'00000001 (1): ON (display of manipulated variable ON)	
1018	300C	Move to Protect Level Time	H'00000001 to H'0000001E (1 to 30)	
101A	300D	PV Change Color	H'00000000 (0): Orange H'00000001 (1): Red H'00000002 (2): Green H'00000003 (3): Red to green: When ALM1 is ON H'00000004 (4): Green to red: When ALM1 is ON H'00000005 (5): Red to green to red: Within PV stable band: Green Outside stable band: Red H'00000006 (6): Green to orange to red: Within PV stable band: Orange Outside stable band: Green, red H'00000007 (7): Orange to green to red: Within PV stable band: Green Outside stable band: Orange, red H'00000008 (8): Red to orange to green: Linked to program. Rising: red, Constant: orange, Falling: green	
101C	300E	PV Stable Band	Temperature: H'00000001 to H'00007E90 (0.1 to 3240.0) Analog: H'00000001 to H'0000270F (0.01 to 99.99)	
101E	300F	Auto/Manual Select Addition	H'00000000 (0): OFF H'00000001 (1): ON	
1020	3010	Character Select	H'00000000 (0): OFF H'00000001 (1): ON	

Note 1: Not displayed on the Controller display when Alarm 3 is not assigned to the output.

SECTION 5 Communications Data for Modbus

Address		Parameter name	Setting (monitor) value	Level
Four-byte mode	Two-byte mode			
1022	3011	PV Status Display Function	H'00000000 (0):OFF H'00000001 (1): Manual H'00000002 (2): Reset H'00000003 (3): Alarm 1 H'00000004 (4): Alarm 2 H'00000005 (5): Alarm 3 H'00000006 (6): Alarm 1 to 3 OR status H'00000007 (7): Heater alarm H'00000008 (8): Standby	Advanced function setting
1024	3012	SV Status Display Function	H'00000000 to H'00000008 (0 to 8) * Same as for PV Status Display Function.	
1100	3100	Communications Protocol Setting (See note 1.)	H'00000000 (0): CompoWay/F H'00000001 (1): Modbus	Communications setting
1102	3101	Communications Unit No. (See note 1.)	H'00000000 to H'00000063 (0 to 99)	
1104	3102	Communications Baud Rate (See note 1.)	H'00000000 (0): 1.2 H'00000001 (1): 2.4 H'00000002 (2): 4.8 H'00000003 (3): 9.6 H'00000004 (4): 19.2 H'00000005 (5): 38.4 H'00000006 (6): 57.6	
110A	3105	Communications Parity (See note 1.)	H'00000000 (0): None H'00000001 (1): Even H'00000002 (2): Odd	
110C	3106	Send Data Wait Time (See note 1.)	H'00000000 to H'00000063 (0 to 99)	
1200	3200	PF Setting	H'00000000 (0): OFF H'00000001 (1): RUN H'00000002 (2): Reset H'00000003 (3): Run/reset H'00000004 (4): Hold/clear hold H'00000005 (5): Advance H'00000006 (6): 100% AT execute/cancel H'00000007 (7): 40% AT execute/cancel H'00000008 (8): Alarm latch cancel H'00000009 (9): Auto/manual switch H'0000000A (10): Monitor/setting item	Advanced function setting
1204	3202	Monitor/Setting Item 1	H'00000000 (0): Disable H'00000001 (1): PV/SP/program No. or segment No. H'00000002 (2): PV/SP/MV H'00000003 (3): PV/SP/remaining segment time H'00000004 (4): Proportional band H'00000005 (5): Integral time H'00000006 (6): Derivative time H'00000007 (7): Alarm value 1 H'00000008 (8): Alarm value upper limit 1 H'00000009 (9): Alarm value lower limit 1 H'0000000A (10): Alarm value 2 H'0000000B (11): Alarm value upper limit 2 H'0000000C (12): Alarm value lower limit 2 H'0000000D (13): Alarm value 3 H'0000000E (14): Alarm value upper limit 3 H'0000000F (15): Alarm value lower limit 3 H'00000010 (16): Program No. H'00000011 (17): Segment No. H'00000012 (18): Elapsed program time H'00000013 (19): Remaining program time H'00000014 (20): Elapsed segment time H'00000015 (21): Remaining segment time	

Note 1: After communications parameters have been changed, perform a software reset or turn the power OFF and ON again, to enable the changes.

Address		Parameter name	Setting (monitor) value	Level
Four-byte mode	Two-byte mode			
1206	3203	Monitor/Setting Item 2	H'00000000 to H'00000015 (0 to 21) * Same as for Monitor/Setting Item 1.	Advanced function setting
1208	3204	Monitor/Setting Item 3	H'00000000 to H'00000015 (0 to 21) * Same as for Monitor/Setting Item 1.	
120A	3205	Monitor/Setting Item 4	H'00000000 to H'00000015 (0 to 21) * Same as for Monitor/Setting Item 1.	
120C	3206	Monitor/Setting Item 5	H'00000000 to H'00000015 (0 to 21) * Same as for Monitor/Setting Item 1.	
1300	3300	Startup Operation	H'00000000 (0): Continue control at final SP H'00000001 (1): Reset H'00000002 (2): Run H'00000003 (3): Manual (See note 1.)	
1302	3301	SP Tracking	H'00000000 (0): OFF H'00000001 (1): ON	
1304	3302	PID Set Automatic Selection Data	H'00000000 (0): PV H'00000001 (1): DV H'00000002 (2): SP	
1306	3303	PID Set Automatic Selection Hysteresis	H'0000000A to H'0000270F (0.10 to 99.99)	
1308	3304	PV Dead Band	H'00000000 to H'00007E90 (0 to 32400)	
130A	3305	Cold Junction Compensation Method	H'00000000 (0): OFF H'00000001 (1): ON	
1314	330A	$\alpha$	H'00000000 to H'00000064 (0.00 to 1.00)	
131E	330F	AT Calculated Gain	H'00000001 to H'00000064 (0.1 to 10.0)	
1320	3310	AT Hysteresis	Temperature: H'00000001 to H'00007E90 (0.1 to 3240.0) Analog: H'00000001 to H'000003E7 (0.01 to 9.99)	
1322	3311	Limit Cycle MV Amplitude	H'00000032 to H'000001F4 (5.0 to 50.0)	
1328	3314	Heater Burnout Latch	H'00000000 (0): OFF H'00000001 (1): ON	
132A	3315	Heater Burnout Hysteresis	H'00000001 to H'000001F4 (0.1 to 50.0)	
132C	3316	HS Alarm Latch	H'00000000 (0): OFF H'00000001 (1): ON	
132E	3317	HS Alarm Hysteresis	H'00000001 to H'000001F4 (0.1 to 50.0)	
1334	331A	Operation End Operation	H'00000000 (0): Reset H'00000001 (1): Continue control at final SP H'00000002 (2): Fixed SP mode	Initial setting
1338	331C	HB ON/OFF	H'00000000 (0): OFF H'00000001 (1): ON	Advanced function setting
133A	331D	Program End ON Time (See note 1.)	H'00000000 to H'00000064 (0.0 to 10.0) H'FFFFFFF(-1): ON	
133C	331E	Input Error Output	H'00000000 (0): OFF H'00000001 (1): ON	
133E	331F	Input Shift Type	H'00000000 (0): Temperature input 1-point shift H'00000001 (1): Temperature input 2-point shift	
1340	3320	MV at Reset and Error Addition	H'00000000 (0): OFF H'00000001 (1): ON	
1344	3322	RT	H'00000000 (0): OFF H'00000001 (1): ON	
1346	3323	HS Alarm Use	H'00000000 (0): OFF H'00000001 (1): ON	

Note 1: Selection is not possible when ON/OFF control is being used.

Address		Parameter name	Setting (monitor) value	Level
Four-byte mode	Two-byte mode			
1348	3324	LBA Detection Time (See note 1.)	H'00000000 to H'0000270F (0 to 9999)	Advanced function setting
134A	3325	LBA Level	Temperature: H'00000001 to H'00007E90 (0.1 to 3240.0) Analog: H'00000001 to H'0000270F (0.01 to 99.99)	
134C	3326	LBA Band	Temperature: H'00000000 to H'00007E90 (0.0 to 3240.0) Analog: H'00000000 to H'0000270F (0.00 to 99.99)	
1350	3328	Alarm SP Selection	H'00000000 (0): Present SP H'00000001 (1): Segment SP	
1352	3329	Remote SP Enable	H'00000000 (0): OFF H'00000001 (1): ON	
1354	332A	Remote SP Input Error Output	H'00000000 (0): OFF H'00000001 (1): ON	
1356	332B	Manual MV Limit Enable	H'00000000 (0): OFF H'00000001 (1): ON	
1358	332C	Direct Setting of Position Proportional MV	H'00000000 (0): OFF H'00000001 (1): ON	
135A	332D	PV Rate of Change Calculation Period	H'00000001 to H'000003E7 (1 to 999)	
135C	332E	Automatic Cooling Coefficient Adjustment	H'00000000 (0): OFF H'00000001 (1): ON	
135E	332F	Heater Overcurrent Use	H'00000000 (0): OFF H'00000001 (1): ON	
1360	3330	Heater Overcurrent Latch	H'00000000 (0): OFF H'00000001 (1): ON	
1362	3331	Heater Overcurrent Hysteresis	H'00000001 to H'000001F4 (0.1 to 50.0)	
1364	3332	Control Output 1 ON/OFF Count Alarm Set Value	H'00000000 to H'0000270F (0 to 9999)	
1366	3333	Control Output 2 ON/OFF Count Alarm Set Value	H'00000000 to H'0000270F (0 to 9999)	
1368	3334	Standby Time Unit	H'00000000 (0): Hours, minutes H'00000001 (1): Days, hours	
136A	3335	Program SP Shift Value Addition	H'00000000 (0): OFF H'00000001 (1): ON	
136C	3336	RSP Broken-line Correction Display Addition	H'00000000 (0): OFF H'00000001 (1): ON	

Note 1: This parameter can be set only for ON/OFF control.



Address		Parameter name	Setting (monitor) value	Level
Four-byte mode	Two-byte mode			
1500	3500	PID 1 Proportional Band	Temperature: H'00000001 to H'00007E90 (0.1 to 3240.0) Analog: H'00000001 to H'0000270F (0.1 to 999.9)	PID setting
1502	3501	PID 1 Integral Time	Standard, heating/cooling, position proportional (closed): H'00000000 to H'00007E90 (0.0 to 3240.0) Position proportional (floating): H'00000001 to H'00007E90 (0.1 to 3240.0)	
1504	3502	PID 1 Derivative Time	H'00000000 to H'00007E90 (0.0 to 3240.0)	
1506	3503	PID 1 MV Upper Limit	Standard: MV lower limit +0.1 to H'0000041A (MV lower limit +0.1 to 105.0) Heating/cooling: H'00000000 to H'0000041A (0.0 to 105.0) Position proportional (closed): MV lower limit +0.1 to H'0000041A (MV lower limit +0.1 to 105.0)	
1508	3504	PID 1 MV Lower Limit	Standard: H'FFFFFFCE to MV upper limit -0.1 (-5.0 to MV upper limit -0.1) Heating/cooling: H'FFFFFFBE6 to H'00000000 (-105.0 to 0.0) Position proportional (closed): H'FFFFFFCE to MV upper limit -0.1 (-5.0 to MV upper limit -0.1)	
150A	3505	PID 1 Automatic Selection Range Upper Limit	Temperature: H'FFFFFFB1E1 to H'00007E90 (-19999 to 32400) Analog: H'FFFFFFCE to H'0000041A (-5.0 to 105.0)	
150C	3506	PID 1 Cooling Coefficient	H'00000001 to H'0000270F (0.01 to 99.99)	
150E	3507	PID 1 LBA Detection Time	H'00000000 to H'0000270F (0 to 9999)	
1520	3510	PID 2 Proportional Band	Temperature: H'00000001 to H'00007E90 (0.1 to 3240.0) Analog: H'00000001 to H'0000270F (0.1 to 999.9)	
		to		
152E	3517	PID 2 LBA Detection Time	H'00000000 to H'0000270F (0 to 9999)	
1540	3520	PID 3 Proportional Band	Temperature: H'00000001 to H'00007E90 (0.1 to 3240.0) Analog: H'00000001 to H'0000270F (0.1 to 999.9)	
		to		
154E	3527	PID 3 LBA Detection Time	H'00000000 to H'0000270F (0 to 9999)	
1560	3530	PID 4 Proportional Band	Temperature: H'00000001 to H'00007E90 (0.1 to 3240.0) Analog: H'00000001 to H'0000270F (0.1 to 999.9)	
		to		
156E	3537	PID 4 LBA Detection Time	H'00000000 to H'0000270F (0 to 9999)	
1580	3540	PID 5 Proportional Band	Temperature: H'00000001 to H'00007E90 (0.1 to 3240.0) Analog: H'00000001 to H'0000270F (0.1 to 999.9)	
		to		
158E	3547	PID 5 LBA Detection Time	H'00000000 to H'0000270F (0 to 9999)	
15A0	3550	PID 6 Proportional Band	Temperature: H'00000001 to H'00007E90 (0.1 to 3240.0) Analog: H'00000001 to H'0000270F (0.1 to 999.9)	
		to		
15AE	3557	PID 6 LBA Detection Time	H'00000000 to H'0000270F (0 to 9999)	
15C0	3560	PID 7 Proportional Band	Temperature: H'00000001 to H'00007E90 (0.1 to 3240.0) Analog: H'00000001 to H'0000270F (0.1 to 999.9)	
		to		
15CE	3567	PID 7 LBA Detection Time	H'00000000 to H'0000270F (0 to 9999)	
15E0	3570	PID 8 Proportional Band	Temperature: H'00000001 to H'00007E90 (0.1 to 3240.0) Analog: H'00000001 to H'0000270F (0.1 to 999.9)	
		to		
15EE	3577	PID 8 LBA Detection Time	H'00000000 to H'0000270F (0 to 9999)	

## 5.2 Status and Status 2

The figure below shows the structure of the status data.

### ■ Status Structure

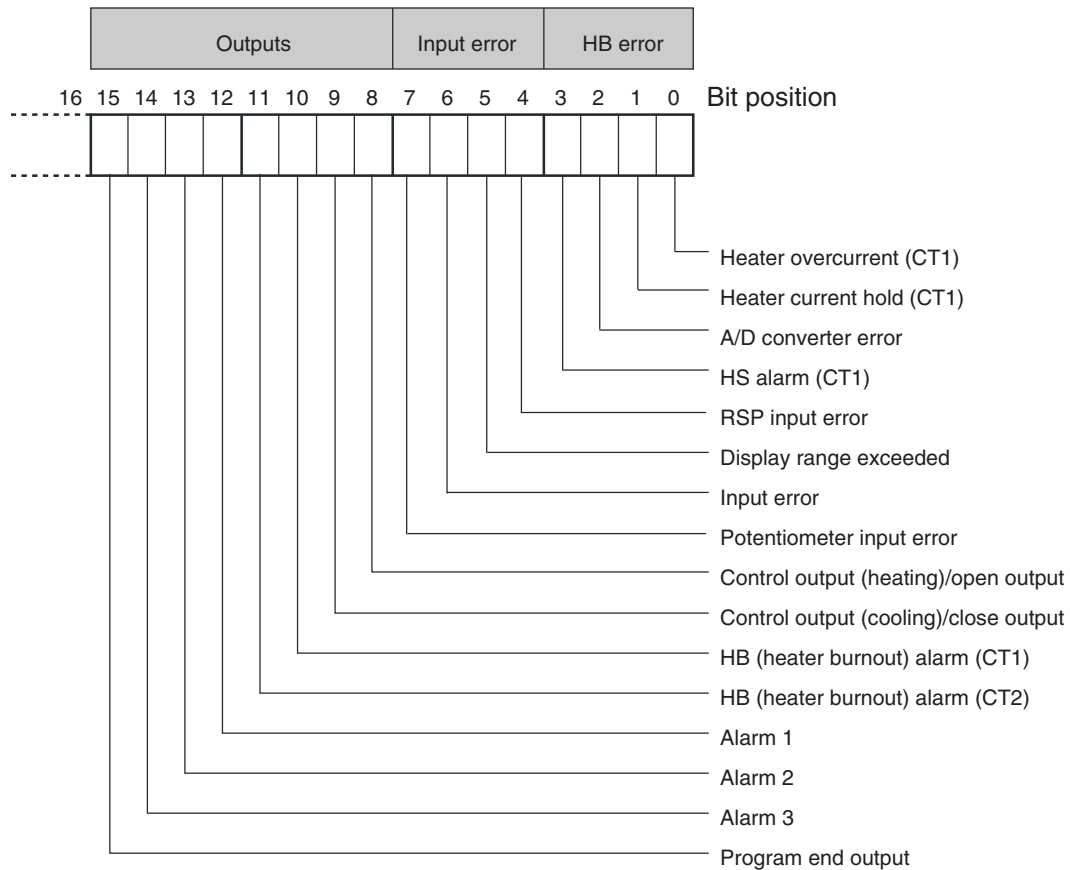

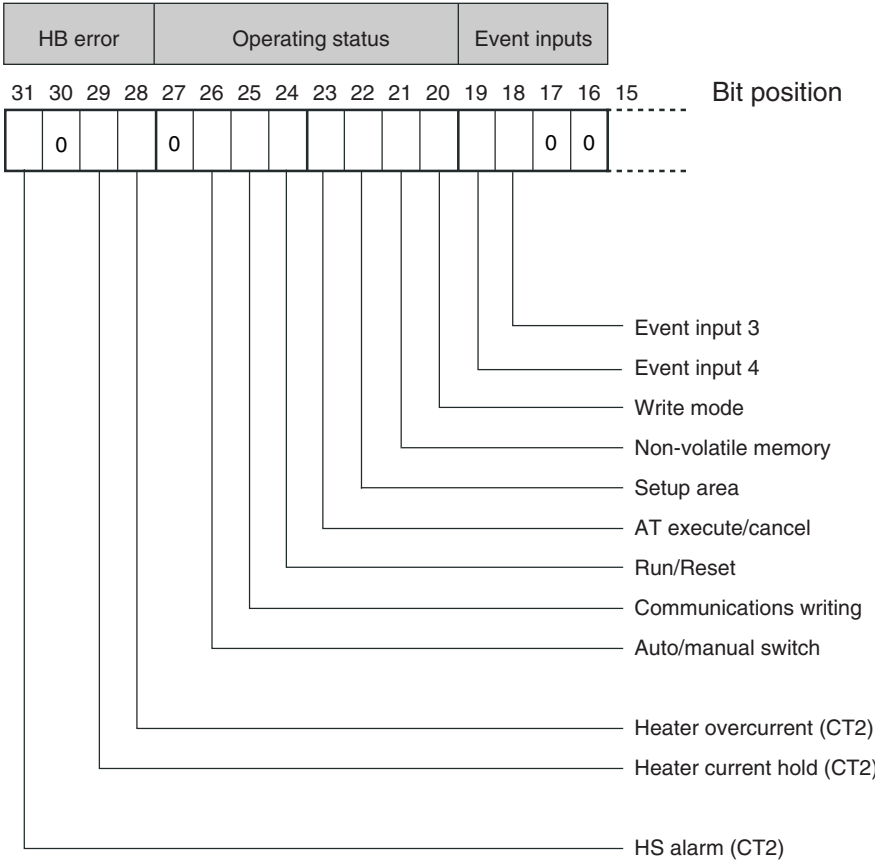

### ■ Status 2 Structure

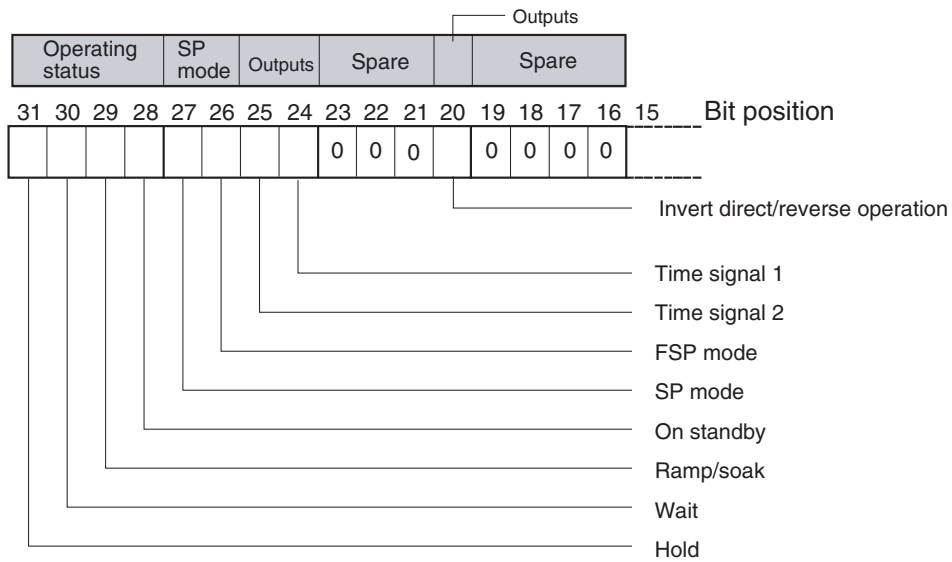
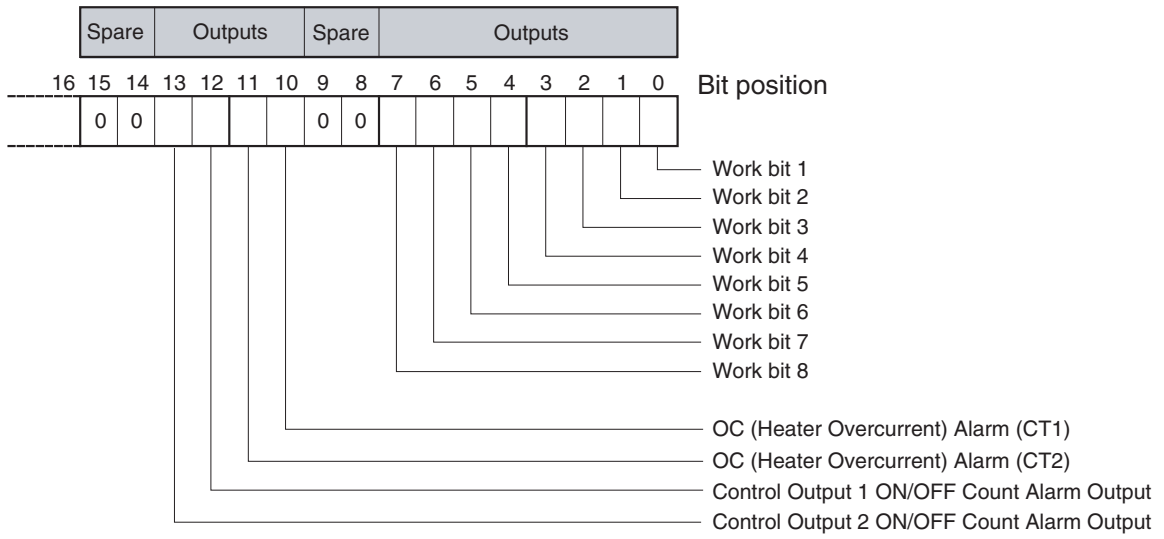

## ■ Status Details

Bit position		Status	Bit Description	
			0	1
Status (lower word)	0	Heater overcurrent (CT1)	Not generated	Generated
	1	Heater current hold (CT1) (See note 1.)	Update	Hold
	2	A/D converter error	Not generated	Generated
	3	HS alarm (CT1)	OFF	ON
	4	RSP input error	Not generated	Generated
	5	Display range exceeded	Not generated	Generated
	6	Input error	Not generated	Generated
	7	Potentiometer input error	Not generated	Generated
	8	Control output (heating)/open output	OFF	ON
	9	Control output (cooling)/close output	OFF	ON
	10	HB (heater burnout) alarm (CT1)	OFF	ON
	11	HB (heater burnout) alarm (CT2)	OFF	ON
	12	Alarm 1	OFF	ON
	13	Alarm 2	OFF	ON
	14	Alarm 3	OFF	ON
15	Program end output	OFF	ON	
Status (upper word)	16	Spare	OFF	---
	17	Spare	OFF	---
	18	Event input 3	OFF	ON
	19	Event input 4	OFF	ON
	20	Write mode	Backup mode	RAM write mode
	21	Non-volatile memory	RAM = Non-volatile memory	RAM ≠ Non-volatile memory
	22	Setup area	Setup area 0	Setup area 1
	23	AT execute/cancel	AT canceled	AT execution in progress
	24	Run/Reset	Run	Reset
	25	Communications writing	OFF (disabled)	ON (enabled)
	26	Auto/manual switch	Automatic mode	Manual mode
	27	Spare	OFF	---
	28	Heater overcurrent (CT2)	Not generated	Generated
	29	Heater current hold (CT2) (See note 1.)	Update	Hold
30	Spare	OFF	---	
31	HS alarm (CT2)	OFF	ON	

Note 1: When the control output ON time is less than 100 ms, the bit is set to "1" and the heater current is held at the last current value.

Note 2: "Spare" bits are always OFF.

Note 3: When read in setup area 1, the status of the bits will be as follows:

- Overcurrent: Last value held
- A/D converter error: Last value held
- Input error: Last value held
- Potentiometer input error: Last value held
- HB and HS outputs: Cleared
- Program end output: Cleared
- Current hold: Last value held
- Display range exceeded: Last value held
- RSP input error: Last value held
- Heating output, cooling output, open output, close output: Cleared
- Alarm outputs: Cleared

## ■ Status 2 Details

Bit position	Status	Bit Description		
		0	1	
Status (lower word)	0	Work bit 1	OFF	ON
	1	Work bit 2	OFF	ON
	2	Work bit 3	OFF	ON
	3	Work bit 4	OFF	ON
	4	Work bit 5	OFF	ON
	5	Work bit 6	OFF	ON
	6	Work bit 7	OFF	ON
	7	Work bit 8	OFF	ON
	8	Spare	OFF	---
	9	Spare	OFF	---
	10	OC (Heater Overcurrent) Alarm (CT1)	OFF	ON
	11	OC (Heater Overcurrent) Alarm (CT2)	OFF	ON
	12	Control Output 1 ON/OFF Count Alarm Output	OFF	ON
	13	Control Output 2 ON/OFF Count Alarm Output	OFF	ON
	14	Spare	OFF	
15	Spare	OFF	---	
Status (upper word)	16	Spare	OFF	---
	17	Spare	OFF	---
	18	Spare	OFF	---
	19	Spare	OFF	---
	20	Invert direct/reverse operation	Not invert	Invert
	21	Spare	OFF	---
	22	Spare	OFF	---
	23	Spare	OFF	---
	24	Time signal 1	OFF	ON
	25	Time signal 2	OFF	ON
	26	FSP mode (See note 1.)	OFF (PSP/RSP)	ON (FSP)
	27	SP mode (See note 1.)	PSP	RSP
	28	On standby	OFF	On standby
	29	Ramp/soak	Soak	Ramp
	30	Wait	OFF	Waiting
	31	Hold	OFF	Holding

Note 1: Bit 27 (SP mode) is enabled when bit 26 (FSP mode) is 1 (ON: FSP).

Note 2: "Spare" bits are always OFF.

Note 3: When read in setup area 1, the status of the bits will be as follows:

- Overcurrent Output: Cleared
- Control Output 1 ON/OFF Count Alarm: Cleared
- Control Output 2 ON/OFF Count Alarm: Cleared
- Work bits 1 to 8: Cleared
- Time signal 1 to 2: Last value held
- FSP mode: Last value held
- SP mode: Last value held
- On standby: Last value held
- Ramp/soak: Last value held
- Wait: Last value held
- Hold: Last value held

# Appendix

ASCII List.....	A-2
Troubleshooting.....	A-3

# ASCII List

	b8								
	b7	0	0	0	0	1	1	1	1
	b6	0	0	1	1	0	0	1	1
	b5	0	1	0	1	0	1	0	1

	b8	b7	b6	b5	b4	b3	b2	b1
Even parity ↑	0	0	0	0	0	0	0	0
	0	0	0	0	1	1	1	1
	0	0	1	1	0	0	0	0
	0	0	1	0	0	0	0	0
	0	1	0	0	0	0	0	0
	0	1	0	1	1	1	1	1
	0	1	1	1	0	0	0	0
	0	1	1	0	0	0	0	0
	0	1	1	1	1	1	1	1
	1	0	0	0	0	0	0	0
	1	0	0	1	1	1	1	1
	1	0	1	1	0	0	0	0
	1	0	1	0	0	0	0	0
	1	1	1	0	0	0	0	0
	1	1	1	0	1	1	1	1
	1	1	1	1	0	0	0	0
1	1	1	1	1	1	1	1	

R \ C	0	1	2	3	4	5	6	7
0	NUL	DLE	SPACE	0	@	P	`	p
1	SOH	DC1	!	1	A	Q	a	q
2	STX	DC2	"	2	B	R	b	r
3	ETX	DC3	#	3	C	S	c	s
4	EOT	DC4	\$	4	D	T	d	t
5	ENQ	NAK	%	5	E	U	e	u
6	ACK	SYN	&	6	F	V	f	v
7	BEL	ETB	'	7	G	W	g	w
8	BS	CAN	(	8	H	X	h	x
9	HT	EM	)	9	I	Y	i	y
A	LF	SUB	*	:	J	Z	j	z
B	VT	ESC	+	;	K	[	k	{
C	FF	FS	,	<	L	\	l	
D	CR	GS	-	=	M	]	m	}
E	SO	RS	.	>	N	^	n	~
F	SI	US	/	?	O	_	o	DEL



# Troubleshooting

## ■ Before Requesting Repairs

If communications are not functioning properly, check the items in the following table before requesting repairs. If normal operation cannot be restored even after checking everything, return the product to your OMRON representative.

**Problem: Communications are not possible or communications errors occur.**

Item	Confirmation	Page
The communications wiring is not correct.	Correct the wiring.	1-4
The communications line has become disconnected.	Connect the communications line securely and tighten the screws.	---
The communications cable is broken.	Replace the cable.	---
The communications cable is too long.	The total cable length is 500 m maximum for RS-485/RS-422 and 15 m maximum for RS-232C communications. To extend the communications distance for RS-232C communications, use Optical Interface.	1-4 1-5
The wrong communications cable has been used.	Use a shielded, twisted-pair, AWG24 to AWG14 (cross-sectional area of 0.205 to 2.081 mm <sup>2</sup> ) cable for the communications cable.	1-4 1-5
Too many communications devices are connected to the communications path for RS-485 communications.	When 1:N, RS-485 communications are used, a maximum of 32 nodes may be connected, including the host node.	1-4
An end node has not been set at each end of the communications line for RS-485/RS-422 communications.	Connect or disconnect terminating resistance so that it is connected only at both ends of the transmission path. For RS-485 communications, use a terminating resistance of 120 Ω (1/2 W) on the E5CN/AN/EN-HT end of the path and make sure the combined resistance including the terminating resistance at the host is 54 Ω minimum. For RS-422 communications, use a terminating resistance of 240 Ω (1/2 W) on the E5AN/EN-HT end of the path and make sure the combined resistance including the terminating resistance at the host is 100 Ω minimum.	1-4
The specified power supply voltage is not being supplied to the Controller.	Supply the specified power supply voltage.	---
The specified power supply voltage is not being supplied to an Interface Converter (e.g., the K3SC).	Supply the specified power supply voltage.	---
The same baud rate and communications method are not being used by all of the Controllers, host devices, and other nodes on the same communications line.	Set the same values for the following on all nodes: baud rate, protocol, data length, stop bits, and parity.	1-4
The unit number specified in the command frame is different from the unit number set for the Controller.	Use the same unit number.	2-2 4-2 5-2
The same unit number as the Controller is being used for another node on the same communications line for RS-485/RS-422 communications.	Set each unit number for only one node.	1-4

Item	Confirmation	Page
There is a mistake in programming in the host device.	Use a line monitor to check the commands. Check operation using a sample program.	---
The host device is detecting the absence of a response as an error before it receives the response from the Controller.	Shorten the send data wait time in the Controller or increase the response wait time in the host device.	1-6
The host device is detecting the absence of a response as an error after broadcasting a command or sending a software reset command.	The Controller does not return responses for broadcast or software reset commands.	2-2 2-14 5-2 5-14
The host device sent another command before receiving a response from the Controller.	Always read the response after sending a command (except for broadcast or software reset commands).	---
The host device sent the next command too soon after receiving a response from the Controller.	Wait for at least 2 ms after receiving a response before sending the next command.	1-3
The communications line became unstable when the Controller's power was turned ON or interrupted, and the host device read the unstable status as data.	Initialize the reception buffer in the host device before sending the first command and after turning OFF the power to the Controller.	---
The communications data was corrupted by noise from the environment.	<p>Try using a slower baud rate.</p> <p>Separate the communications cable from the source of noise.</p> <p>Use a shielded, twisted-pair cable for the communications cable.</p> <p>Use as short a communications cable as possible and do not lay or loop extra cable.</p> <p>Do not run the communications cable parallel to a power line to prevent inductive noise.</p> <p>If noise countermeasures are difficult to implement, use an Optical Interface.</p>	---

# Index

<b>A</b>	addresses		<b>M</b>	Modbus .....1-2, 4-1, 5-1
	CompoWay/F ..... 2-7		<b>N</b>	no response
	Modbus ..... 4-7			Modbus .....4-5
	area definitions ..... 2-6			node number .....2-2
	ASCII list ..... A-2			number of elements
<b>B</b>				CompoWay/F .....2-7
	BCC ..... 1-3, 2-2, 2-3			Modbus .....4-8
<b>C</b>			<b>O</b>	Operation Command
	command frame			CompoWay/F ..... 2-8, 2-19
	CompoWay/F ..... 2-2		<b>P</b>	
	Modbus ..... 4-2			PDU structure .....2-6
	command text .....2-2, 2-6			protocol setting ..... 1-9
	communications baud rate .....1-8, 1-9		<b>R</b>	
	communications data			Read Controller Attributes
	CompoWay/F .....2-4, 3-1			CompoWay/F ..... 2-8, 2-16
	communications data length .....1-8, 1-9			Read Controller Status ..... 2-8, 2-17
	communications methods ..... 1-2			Read Variable Area
	communications parameter setup ..... 1-8			CompoWay/F ..... 2-7, 2-9
	communications parameters .....1-8, 1-9			response code list
	communications parity .....1-8, 1-10			CompoWay/F .....2-26
	communications protocol .....1-8, 1-9			response frame
	communications specifications ..... 1-3			CompoWay/F .....2-3
	communications stop bits .....1-8, 1-10			Modbus .....4-4
	communications unit number .....1-8, 1-9			RS-485 ..... 1-4
	CompoWay/F .....1-2, 2-1		<b>S</b>	
	CRC-16 ..... 4-3			send data wait time ..... 1-8, 1-10
<b>D</b>				services details
	data format			CompoWay/F .....2-9
	CompoWay/F ..... 2-2			list (CompoWay/F) .....2-7
	Modbus ..... 4-2			Modbus .....4-9
<b>E</b>				set values
	Echoback Test			Modbus .....4-8
	CompoWay/F .....2-8, 2-18			SID ..... 2-2, 2-4
	Modbus ..... 4-21			slave address .....4-2
	end code			status ..... 3-20, 5-16
	CompoWay/F .....2-3, 2-4			STX .....2-2
	error code ..... 4-5		<b>T</b>	
	ETX ..... 2-2			transmission procedure ..... 1-3
<b>F</b>				type code (variable type) .....2-6
	FINS .....1-2, 2-3			
	function code ..... 4-2			
	function list ..... 4-6			
<b>I</b>				
	interface ..... 1-4			

**V**

variable area  
    Modbus ..... 4-7  
Variable Area (setting range) list  
    CompoWay/F ..... 3-2  
    Modbus ..... 5-2  
variable type ..... 2-6, 2-7

**W**

wiring ..... 1-4  
Write Variable Area  
    CompoWay/F ..... 2-10

## Revision History

A manual revision code appears as a suffix to the catalog number on the front cover of the manual.

Cat. No. H170-E1-02



The following table outlines the changes made to the manual during each revision. Page numbers refer to the previous version.

Revision code	Date	Revised content
01	December 2010	Original production
02	September 2022	Added information on <i>Safety Precautions</i> .





## **OMRON Corporation Industrial Automation Company**

**Kyoto, JAPAN**

**Contact : [www.ia.omron.com](http://www.ia.omron.com)**

### **Regional Headquarters**

#### **OMRON EUROPE B.V.**

Wegalaan 67-69, 2132 JD Hoofddorp  
The Netherlands  
Tel: (31) 2356-81-300 Fax: (31) 2356-81-388

#### **OMRON ELECTRONICS LLC**

2895 Greenspoint Parkway, Suite 200  
Hoffman Estates, IL 60169 U.S.A.  
Tel: (1) 847-843-7900 Fax: (1) 847-843-7787

#### **OMRON ASIA PACIFIC PTE. LTD.**

438B Alexandra Road, #08-01/02 Alexandra  
Technopark, Singapore 119968  
Tel: (65) 6835-3011 Fax: (65) 6835-2711

#### **OMRON (CHINA) CO., LTD.**

Room 2211, Bank of China Tower,  
200 Yin Cheng Zhong Road,  
PuDong New Area, Shanghai, 200120, China  
Tel: (86) 21-5037-2222 Fax: (86) 21-5037-2200

**Authorized Distributor:**

©OMRON Corporation 2010-2022 All Rights Reserved.  
In the interest of product improvement,  
specifications are subject to change without notice.

**Cat. No. H170-E1-02**

0922