

Natural Cooling Three-phase Power Supply Range from 5A up to 40A with Output Voltage of 24VDC

- 3 phase 400 to 500 VAC
- 5, 10, 20 and 40 A; 24 VDC output
- Higher stability, lower ripple and noise level
- Mounts to DIN rail
- Fuses protection included
- Natural ventilation
- UL60950 (CSA22.2-60950), UL508 listing in addition to the CE mark
- Conform to EN61000-3-2
- Parallel & serial operation possible

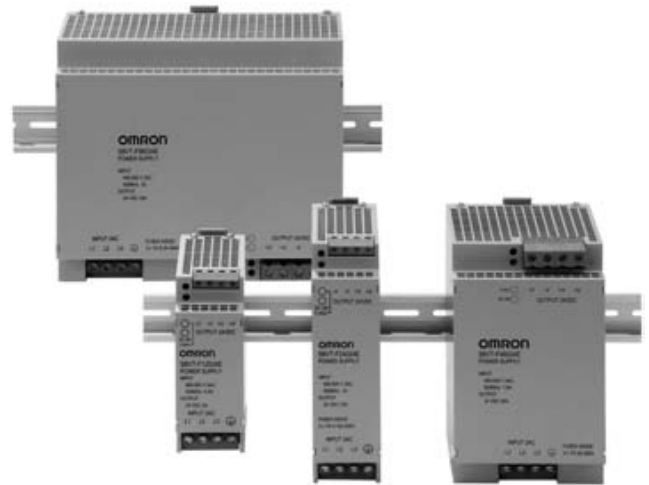

Model Number Structure

Model Number Legend

S8VT - 24 E

1 2 3

1. Input Voltage

F: 400 to 500 VAC 3-phase

2. Power Rating

120: 120 W
240: 240 W
480: 480 W
960: 960 W

3. Output Voltage

24: 24 V

Ordering Information

List of Models

Input voltage	Power rating	Output voltage	Output current	Model number
400 to 500 VAC 3-phase	120 W	24 V	5 A	S8VT-F12024E
	240 W	24 V	10 A	S8VT-F24024E
	480 W	24 V	20 A	S8VT-F48024E
	960 W	24 V	40 A	S8VT-F96024E

Specifications

Item	Nominal Input Voltage	F: 400 to 500 VAC			
	Nominal Input Current	5 A	10 A	20 A	40 A
Efficiency (400 VAC FULL LOAD)		86%	90%	91%	91%
Input	Voltage range	340 to 576 V 3AC resp. 480 to 810 VDC			
	Frequency	50 to 60 Hz			
	Current (max.) (Vin = Range min., Pmax)	0.5A	1A	1.5A	3A
	Power factor (400 VAC FULL LOAD)	0.66	0.66	0.86	0.86
	Leakage current (max.)	<3.5mA	<3.5mA	<3.5mA	<3.5mA
	Inrush current (max.) (Pmax)	< 30A @ Vin max.	< 30A @ Vin max.	< 40A @ Vin max.	< 30A @ Vin max.
	EMI filter	2x10 mH	2x27 mH	2x6.8 mH	2x2.2 mH
Line fuses	T2A	T3.15A	T4A	T6.3A	
Output	Voltage adjustment range	21.6 to 28.0 VDC min.			
	Tolerance adjustment accuracy	1%			
	Ripple & noise (Pmax.)	100 mV max. (p.p. 0-20 MHz)			
	Load variation influence	±0.5% max.			
	Input variation influence	±0.25% max.			
	Temperature variation influence	Less than 0.05%/°C			
	Startup time (max.)	1.3 s	1.3 s	1.3 s	1.3 s
	Hold time (min.) (Vin = 400 VAC)	15 ms	15 ms	15 ms	15 ms
	Protection	<ul style="list-style-type: none"> - Short circuit protection continuative - Over load protection - Over voltage protection 			
	Parallel operation	Yes (for two units)			
	Serial operation	Yes (for two units)			
Indicator	Yes (Green LED)				
Others	Heat radiation	Natural air cooling			
	Ambient temperature	-10 to 70°C (de-rating: 5%/°C for 60 to 70°C)			
	Temperature power derating	60 to 70°C see diagram			
	Storage temperature	-40 to 85°C			
	Ambient humidity	10 to 90% noncondensing			
	Dielectric strength	2.5 kVAC Input-PE (for 1 sec.; routine test) 3 kVAC Input-Output on isolation components (transformers) (for 1 sec.; high-pot routine test) 1 kVAC Output-PE (for 1 sec.; routine test).			
	Insulation resistance	500 Mohm min at 500 VDC, Output - P.E.			
	Vibration resistance	10 to 55 Hz, 0.375 mm single amplitude for 2 h each in X, Y and Z directions 10 to 150 Hz, 0.35 mm single amplitude for 80 min each in-X, Y and Z directions			
	Shock resistance	150 m/s ² , 3 times each in ±X, ±Y, ±Z directions			
	EMC	EN55011 (EN55022) EN61000-3-2, EN61000-4-2, EN61000-4-3, EN61000-4-4, EN61000-4-5, EN61000-4-6, EN61000-4-8, EN61000-4-11, EN61204-3			
	Approval standards (AC and DC input)	IEC60950-1, EN60950-1 UL60950-1, CSA 22.2 No. 60950-1, UL508 Listed *1, EN50178, EN60204			
	Life expectancy	10 years (Vin=400-500 VAC 50% of rated output current Ta=40°C)			
	MTBF *2	> 300.000hrs			
	Weight	0.71 kg	0.91 kg	1.8 kg	3.3 kg

*1) UL approval up to 600 VDC

*2) MTBF stands for Mean Time Between Failures, which is calculated according to the probability of accidental device failures, and indicates reliability of devices.

Operation

Block Diagram

S8VT-F

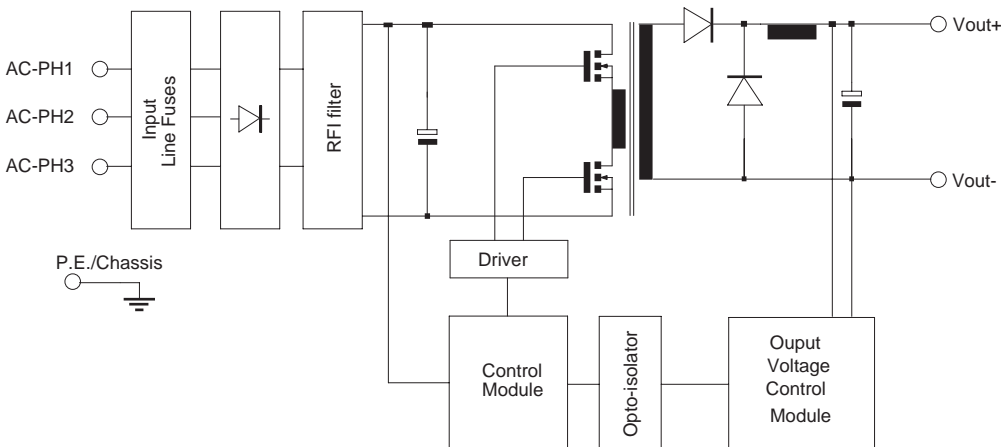

Engineering Data

Definition of Inrush Current, Start up Time and Hold Time

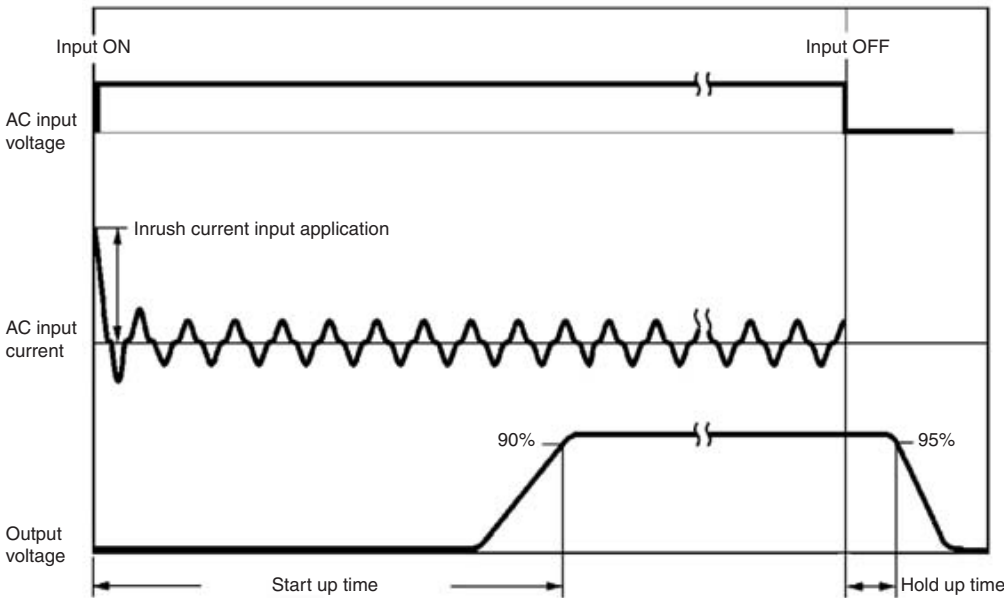

Overload Protection

The Power supply is provided with an overload protection function that protect the load and the power supply from possible damage by over current. When the output current rises above between 105 to 130% (105 to 120% for the 40 A model) of the rated current, the protection function is triggered, decreasing the output voltage. When output current falls within the rated range, the overload protection function is automatically cleared.

De-rating Curve

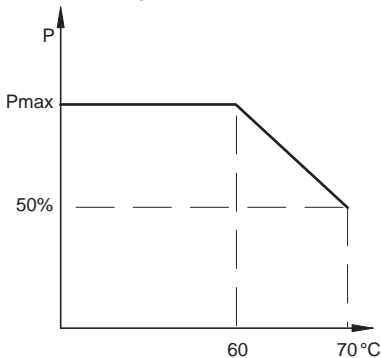

For UL and CSA the maximum temperature is 60°C (70°C for the 20 A model)

Overvoltage Protection

5 A and 10 A models

If output voltage exceed the rated voltage more than 25% (50% at maximum) by some reason, then the output voltage will be automatic limited for safety.

20 A and 40 A models

If output voltage exceed the rated voltage more than 25% (50% at maximum) by some reason, then the output voltage will be turned OFF automatically for safety. To restart the S8VT, turn OFF the input voltage, wait few minutes, then apply the input power again.

Dimensions and Nomenclature

Note: All dimensions shown are in millimeters.

S8VT-F12024E

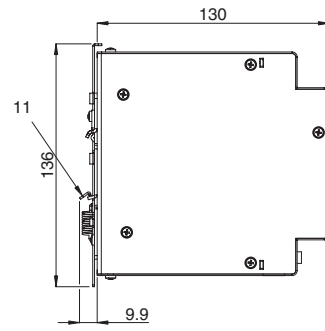
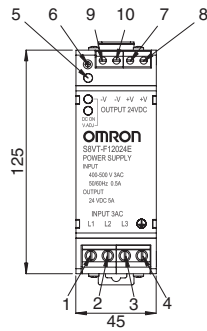

S8VT-F24024E

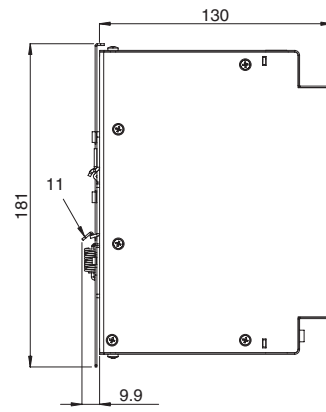
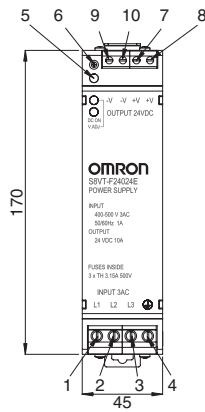

S8VT-F48024E

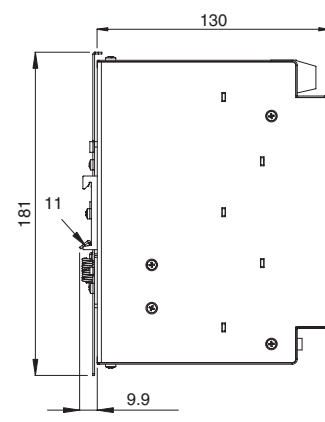
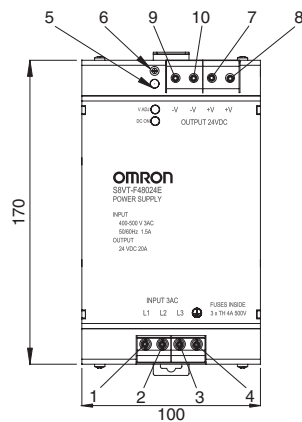

S8VT-F96024E

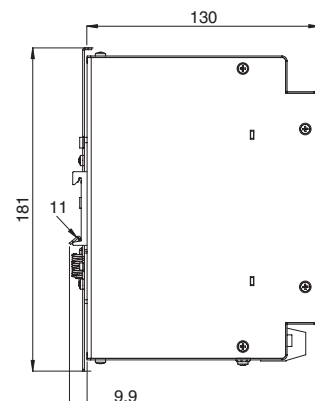
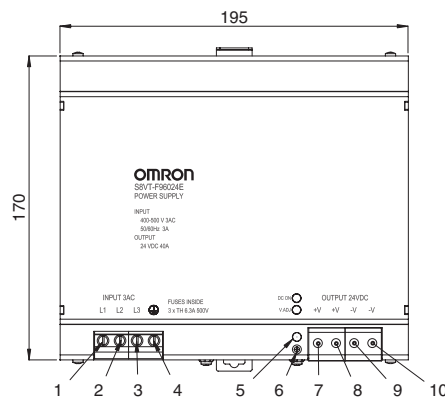

- 1. AC input L1
- 2. AC input L2
- 3. AC input L3
- 4. P.E. (Protective Earth)

- 5. LED Vout ok
- 6. Vadj. Trim
- 7. Vout +
- 8. Vout -

- 9. Vout -
- 10. Vout -
- 11. DIN-rail clip

Notice

Three phase input operation when one phase is missing

The S8VT will in most cases continue to operate even after the loss of one phase of the supply. The performance specifications are of course not guaranteed under these conditions. As the loss of one phase puts additional stress on some components, the life span of the unit could be shortened. It is prudent therefore to regularly check for signs of the following possible conditions.

1. Input terminals wiring open/loose.
2. Incorrect/No voltage on one or more phases of the supply.
3. Abrupt or periodical loss of input voltage.

The power supply needs output derating as in the chart for the operation on missing phase at the input voltage range of 340 to 576 V. Otherwise, the power supply may deteriorate or be damaged.

In every single application suitability has to be checked.

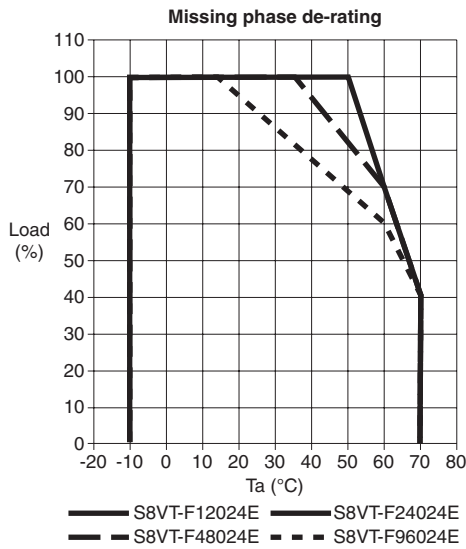

Note: In two phase operation, the specification for EMC performance, hold-up time, efficiency and output ripple will no longer be valid.

Three phase input switch off

In order to switch off the Power Supply completely: All 3 phases need to be switched off.

Mounting

To improve and maintain the reliability of the Power Supply over a long period, adequate consideration must be taken to heat radiation.

The S8VT is designed to radiate heat by natural air cooling, therefore, mount the S8VT so that enough air flow takes place around the power supply.

If installing S8VTF closely, keep the minimum distance of 20 mm at 60°C ambient.

Generating (±) Output Voltage

An output of ± can be generated as shown below, since the S8VT has a floating output.

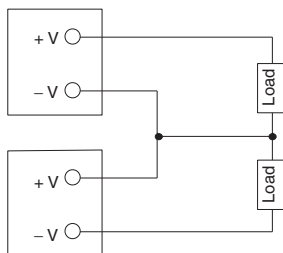

Serial Operation

As shown below, the output voltage from each S8VT can be added. Types must be the same.

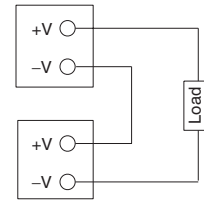

Parallel Operation

As shown below, two S8VT-F (same capacity model) can be paralleled to boost the output power (current). Set the output voltages of the Power Supplies to the same value.

Also, make sure that the thickness and the length of all wires connected to the load are the same to ensure that the wires will have no voltage drop difference.

Parallel connection is only permissible with ambient temperature from -10°C to +50°C.

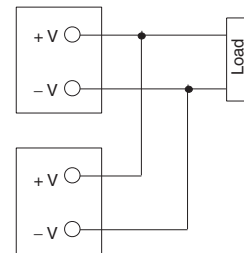

In case of a redundant system or back-up system, use diode to be connected to output + terminal of all the Power Supplies.



Safety Precautions

Safety Signal words

This document uses the following signal words to mark safety precautions for the S8VT. These precautions provide important information for the safe application of the product. You must be sure to follow the instructions provided with safety signal words.

 WARNING	Indicates information that, if ignored, could possibly result in loss of life or seriously injury.
 Caution	Indicates information that, if ignored, could result in relatively serious or minor injury, damage to the product, or faulty operation.

 **WARNING**

Be sure to connect the grounding line. Not doing so may result in electric shock.

 **Caution**

Do not attempt to disassemble the Power Supply or touch its internal parts while power is being supplied. Doing so may result in electric shock.

 **Caution**

Do not touch the S8VT while the power is being supplied or immediately after the power is turned OFF. The case of the Power Supply can be still hot.

<p>ALL DIMENSIONS SHOWN ARE IN MILLIMETERS. To convert millimeters into inches, multiply by 0.03937. To convert grams into ounces, multiply by 0.03527.</p>
